

**NOTICE OF MEETING OF THE BOARD OF TRUSTEES OF  
HARRIS COUNTY DEPARTMENT OF EDUCATION**

Notice is hereby given that a meeting of the Board of Trustees of Harris County Department of Education will be held on the **21st day of July 2021 at 1:00 p.m.** for the Board to conduct the business of that meeting. The meeting will be held in the Board Room of the Administration Building, 6300 Irvington Boulevard, Houston Texas. Such a meeting is a **REGULAR BOARD MEETING**.

The subjects to be discussed or considered or upon which any formal action might be taken are on the Agenda following.

Additionally, from time to time an issue will be raised concerning an item on our agenda that had not been anticipated. The issue, while within the scope of the agenda topic, may be one that is required or authorized by law to be considered in executive session rather than in public session. In order for the Board to consider such issue in executive session, rather than postpone consideration of it until the next board meeting, the Board lists below most if not all be all of the sections of the Open Meetings Act that address the purposes for which the Board may lawfully meet in executive/closed session. The Board's purpose is not to meet in executive session to consider matters not on the agenda for the meeting. Instead, its purpose is to efficiently and timely conduct its business in accordance with the law.

Therefore, if, during the course of the meeting on agenda items covered by this Notice, the Board should determine that a closed or executive meeting or session of the Board should be held or is required in relation to any item included in this notice, then such closed or executive meeting or session as authorized by Section 551.001 et seq. of the Texas Government Code (the Open Meetings Act) will be held by the Board at the date, hour, and place given in this notice or as soon after the commencement of the meeting covered by this notice as the Board may conveniently meet in such closed or executive meeting or session concerning any and all subjects and purposes authorized by Sections 551.071-551.084, inclusive, of the Open Meetings Act, including, but not limited to:

- Section 551.071 For the purpose of a private consultation with the Board's attorney on any or all subjects matters authorized by law.*
- Section 551.072 For the purpose of discussing the purchase, exchange, lease or value of real property. For the purpose of considering a negotiated contract for a prospective gift or donation.*
- Section 551.073 For the purpose of considering the appointment, employment, evaluation, reassignment, duties, discipline or dismissal of a public officer or employee or to hear*
- Section 551.074 complaints or charges against a public officer or employee. To consider the deployment, or specific occasions for implementation of security personnel or devices.*
- Section 551.076 For the purpose of considering discipline of a public school child or children or to hear a complaint by an employee against another employee if the complaint or charge*
- Section 551.082 directly results in a need for a hearing. For the purpose of considering the standards, guidelines, terms or conditions the Board will follow, or instruct its representatives to follow, in consultation with*
- Section 551.083 representatives of employee groups in connection with consultation agreements provided for by Section 13.901 of the Texas Education Code. For the purpose of excluding witness or witnesses from a hearing during examination of another witness.*

*Section 551.084*

Should any final action, final decision, or final vote be required in the opinion of the Board with regard to any matter considered in such closed or executive session, then such final action, final decision, or final vote shall be at either: a) the open meeting covered by this notice upon the reconvening of this public meeting, or b) at a subsequent public meeting of the Board upon notice thereof, as the Board shall determine.

*James Colbert, Jr., County School Superintendent*



**The Board of Trustees  
July 21, 2021  
Agenda of Regular Meeting**

---

A Regular Meeting of the Board of Trustees of Harris County Department of Education will be held July 21, 2021, beginning at 1:00 p.m. in the Board Room of the Administration Building, 6300 Irvington Boulevard, Houston Texas.

The subjects to be discussed or considered or upon which any formal action may be taken are as listed below. Items do not have to be taken in the order shown on this meeting notice.

Unless removed from the consent agenda, items identified within the consent agenda will be acted on at one time.

1. **Invocation** - Jessica Bermea, Business Services
2. **Pledge of Allegiance to the US flag** - Junior Board Members
3. **Pledge of Allegiance to the Texas flag** - Junior Board Members
4. **Swearing in of Junior Board Members and Board Resolution** - Danny Norris, Board President
5. **Public Hearing on HCDE 2021-2022 Budget** 10
6. **Open Forum** - Gov't Code 551.003 (5) - Public Participation. Pursuant to Policy BED (Local), a citizen who wishes to speak may do so by completing a participation request card available at the Board room at least 10 minutes prior to a regular Board meeting.
7. **Reports and presentations:** 33
  - A. **Recognition of CASE Debates' national champions from Elsie High School** - Anthony Hoang, Diego Castillo, Ebenezer Appiah & Rodrigo Trujillo
  - B. **Superintendent Monthly Report** - James Colbert, Jr.
  - C. **Announcement of award from the Association of School Business Officials International (ASBO) for the HCDE 2020 Comprehensive Annual Financial Report (CAFR)** - Jesus Amezcua, Assistant Superintendent for Business Services 34
  - D. **Annual Division Update on Business Services** – Dr. Jesus Amezcua, Assistant Superintendent for Business Services
  - E. **Annual Division Update on Purchasing** – Kendra Jackson, Director

F.	<b>Other reports from Board members</b> concerning attendance or participation in a board or HCDE-related conference, event, activity, or committee; accolades for an HCDE staff member or other deserving person.	
G.	<b>Report of Board Committees - Committee Chairs</b>	
H.	<b>Monthly Financial Reports through 06/30/2021-</b> Jesus Amezcua, Assistant Superintendent for Business Services	39
8.	<b>ACTION ITEMS - CONSENSUS</b>	
A.	<u>Consider approval of the following Business Services items:</u>	
1.	Monthly Disbursement Report	121
2.	Monthly Budget Amendment Report	
3.	Monthly Investment Report for June 2021	206
B.	<u>Consider approval of the following Board Meeting Minutes</u>	225
1.	06/15/2021 Budget Committee Meeting	226
2.	06/15/2021 Special Board Meeting	227
3.	06/16/2021 Government Relations Committee Meeting	230
4.	06/16/2021 Board Meeting Minutes	231
C.	<u>Consider acceptance of the following grant award:</u>	
1.	<b>Acceptance of funds totaling \$1,700,000 from the Texas Education Agency</b> for CASE for Kids' Nita M. Lowey 21st Century Community Learning Center(s) Cycle 11, Year 1 grant for the period 07/01/2021 through 07/31/2022; CASE for Kids anticipates serving 1,046 students and hiring 13 full-time positions and up to 50 quarter-time positions with these grant funds.	244
D.	<u>Consider ratification/approval of the following Interlocal Contracts and contract awards for County Connections-Youth Summer Initiative:</u>	
1.	<b>Approval of Interlocal (revenue) contracts for FY 2022 for Therapy Services in the aggregate amount of \$3,573,556 with School-Based Therapy Services and the following districts:</b> Spring ISD (441 students served in FY20) in the amount of \$999,658; and Katy ISD (1390 students served in FY20) in the amount of \$2,573,898.	252
2.	<b>Approval of Interlocal (revenue) contract with Spring Branch ISD and the Center for Safe and Secure Schools Division for School Safety Audits over a two-year cycle</b> (July 26, 2021 through June 30, 2023) in an amount not to exceed \$70,268, servicing 62 sites.	255

3. **Approval of Interlocal (revenue) contract for FY 2022 in the aggregate amount of \$391,495 with Academic and Behavior School East with the following district:** La Porte ISD for seven (7) in-county annual contracts in the amount of \$144,235 (\$20,605 each); Spring ISD for twelve (12) in-county annual contracts in the amount of \$247,260 (\$20,605 each); for the contract period of 8/23/2021 through 06/03/2022. 263
  
4. **Approval of Interlocal (revenue) contracts for FY 2022 in the aggregate amount of \$281,372 with Highpoint School East with the following districts:** Deer Park ISD for nine (9) in-county annual contracts in the amount of \$90,441 (\$10,049 each); Galena Park ISD for five (5) in-county annual contracts in the amount of \$50,245 (\$10,049 each); La Porte ISD for six (6) in-county annual contracts in the amount of \$60,294 (\$10,049 each); and Spring Branch ISD for eight (8) in-county annual contracts in the amount of \$80,392 (\$10,049 each) for the contract period of 08/23/2021 through 06/03/2022. 274
  
5. **Approval of Interlocal (revenue) contract for Summer School FY 2021 in the aggregate amount of \$92,896 with Academic and Behavior School West with the following district:** Fort Bend ISD for sixteen (16) out of-county Extended School Year (ESY-Summer School) contracts in the amount of \$92,896 (\$5,806 each) for the time period of 06/14/2021 through 07/16/2021. 300
  
6. **Approval of Addendum #1 to Interlocal (revenue) contract between Academic and Behavior School West and Houston ISD** to increase the aggregate amount from \$412,100 to \$427,934 (an increase of \$15,834) for three (3) additional units for FY 2021 Extended School Year Services (ESY) Summer School (in-county \$5,278) for the time period of 06/14/2021 through 07/16/2021. 329
  
7. **Ratification of award RFP#21/044KJ for County Connections-Youth Summer Initiative and Approve aggregate expenditures of \$55,000 from CASE for Kids to Social Motion Inc.:** County Connections' grant award (Expenditure Contracts) totaling \$20,000 for Social Motion Inc. for Summer 2021 programming is in addition to prior awards of \$20,000 in Partnership Project funding, and a prior award of \$15,000 in City Connections funding for a total aggregate amount of \$55,000. County Connections will increase number of students served, number of sites served and/or timeframe in which students are served. 331
  
8. **Ratification of award RFP#21/044KJ for County Connections-Youth Summer Initiative and Approve aggregate expenditures of \$90,000 from CASE for Kids to the YMCA of Greater Houston:** County Connections' grant award (Expenditure Contracts) totaling \$30,000 for YMCA of Greater Houston for summer 2021 programming is addition to prior awards of \$40,000 in Partnership Project funding and \$20,000 in City Connections funding for a total aggregate amount of \$90,000. County Connections will increase number of students served, number of sites served and/or timeframe in which students are served. 340
  
9. **Ratification of award RFP#21/044KJ for County Connections-Youth Summer Initiative and Approve aggregate expenditures of \$58,900 from CASE for Kids to the Houston Tennis Association** County Connections' grant award (Expenditure Contracts) totaling \$30,900 for Houston Tennis Association for Summer 2021 programming is in addition to prior awards of \$20,000 in Partnership Project funding and \$8,000 Select Service funding for a total aggregate amount of \$58,900. County Connections will increase number of students served, number of sites served and/or timeframe in which students are served. 366

10. **Ratification of award RFP#21/044KJ for County Connections-Youth Summer Initiative and Approve aggregate expenditures of \$81,100 from CASE for Kids to Multicultural Counseling and Education for the Arts (MECA) per CH Local FY21:** County Connections' grant award (Expenditure Contracts) totaling \$20,000 for MECA Dow School for Summer 2021 programming is in addition to prior awards of \$40,000 in Partnership Project, \$5,000 in City Connections, and \$16,100 in Select Services. County Connections will increase number of students served, number of sites served and/or timeframe in which students are served. 392
11. **Ratification of award RFP#21/044KJ for County Connections-Youth Summer Initiative and Approve aggregate expenditures of \$80,000 from CASE for Kids to Boys and Girls Club of Greater Houston:** County Connections' grant award (Expenditure Contracts) totaling \$30,000 for Boys and Girls Club of Greater Houston for Summer 2021 programming is in addition to prior awards of \$40,000 in Partnership Project funding and \$10,000 in City Connections funding for a total aggregate amount of \$80,000. County Connections will increase number of students served, number of sites served and/or timeframe in which students are served. 401
- E. Consider approval of the following items for the HCDE Choice Partners Cooperative:
1. **Approval of Contract Renewal option for job no. 18/061JN for JOC-IDIQ for Modular Buildings & Related Items with the following vendors:** Aries Building Systems, LLC (#18/061JN-01), and JR Thomas Group, Inc. (#18/061JN-03) for the period 08/15/2021 through 08/14/2022. 426
2. **Approval of Contract Renewal option for job no. 19/047KC for Communications, Creative and Marketing Services & Related Items with the following vendors:** Alboum & Associates dba Alboum Translation Services (#19/047KC-01); Love Advertising, Inc. (#19/047KC-03), and Versa Creative Group, Inc. (#19/047KC-04) for the period 08/21/2021 through 08/20/2022. 429
3. **Approval of Contract Renewal option for job no. 19/048MR for Pest, Lawn, Pool Chemical Supplies & Services with the following vendors:** Copesan Service, Inc. dba Holder's Pest Solutions (#19/048MR-01), and JR Simplot Company dba Simplot (#19/048MR-02) for the period 08/21/2021 through 08/20/2022. 433
4. **Approval of Contract Renewal option for job no. 19/051TP Frozen Dessert Products with the following vendors:** Dippin' Dots (19/051TP-02), and Southern Ice Cream (19/051TP-03) for the period 08/22/2021 through 08/21/2022. 436
5. **Approval of Contract Renewal option for job no. 20/046SG for Award Jackets, Apparel, Screen Printing and Embroidery with the following vendors:** 4imprint, Inc. (#20/046SG-01); Balfour Company (#20/046SG-04); Buffalo Specialties, Inc. (#20/046SG-05); JW Drouin & Associates dba J. Harding & Co. (#20/046SG-08); Marketing Magic International, Ltd (#20/046SG-09); Tejas Office Products, Inc. (#20/046SG-12); Texas Music Festivals Enterprise, Inc. (#20/046SG-13), and Trademarks Promotional Products, LP (#20/046SG-14) for the period 08/19/2021 through 08/18/2022. 439

6. **Approval of the Contract Award for job no. 21/039MR for Job Order Contracting IDIQ Minor Construction with the following vendors:** Aggieland Construction, Ltd (#21/039MR-01); Blue Ox Construction, Inc. (#21/039MR-02); Brown & Root Industrial Services, LLC (#21/039MR-03); RMB Management, LLC dba Corestone Construction Services (#21/039MR-04); Dura Pier Facilities Services, LTD dba Facilities Sources (#21/039MR-05); Falkenberg Construction Co., Inc. (#21/039MR-06); Flintco, LLC (#21/039MR-07); Generocity Services, Inc. (#21/039MR-08); H.B. Neild & Sons, Inc. (#21/039MR-09); Domingo V. Lopez, III dba JL Squared Construction (#21/039MR-10); Quad-Tex Construction, Inc. (#21/039MR-11); SDB, Inc. (#21/039MR-12); SterlingStructures, Inc. (#21/039MR-13); The Pounds Group, LLC dba Sullivan Contracting Services (#21/039MR-14); Texas General Contractors, Inc. (#21/039MR-15), and The Trevino Group, Inc. (#21/039MR-16) for the period 07/21/2021 through 07/20/2022. 448
7. **Approval of the Contract Award for job no. 21/048SG for Promotional and Commemorative Items with the following vendors:** 4imprint, Inc. (#21/048SG-01); Blink Marketing, Inc. (#21/048SG-02); Buffalo Specialties, Inc. (#21/048SG-03), and Liberty Data Products, Inc. dba Liberty Office Products (#21/048SG-04) for the period 07/21/2021 through 07/20/2022. 646
8. **Approval of the Contract Award for job no. 21/058MJ for Energy Purchase with the following vendors:** NRG Energy, Inc. dba Reliant Energy Retail Services, LLC (#21/058MJ-01), and Vistra Preferred, Inc. dba TXU Energy Retail Company, LLC (#21/058MJ-02) for the period 07/21/2021 through 07/20/2022. 796
9. **HCDE Interlocal Agreements with:** Barbers Hill ISD, Mont Belvieu, Texas - Signature Only; Deer Park ISD, Deer Park, Texas - Signature Only; Cisco ISD, Cisco, Texas; New Mexico State University (NMSU), Las Cruces, New Mexico - Signature Only, and Polk County, Livingston, Texas. 850
- F. Consider approval of the following items for Internal Purchasing:
1. **Approval of Contract Renewal option for job no. 17/046MR for Playground Equipment and Supplies with the following vendor:** Kaplan Early Learning Company for the period of 08/16/2021 through 08/15/2022. 885
2. **Approval of Contract Renewal options for job no. 18/049YR for CASE for Kids After School and Summer Direct Service Providers with the following vendors:** Alliance Financial Ministries, Inc., American Robotics Academy (Animation Station Inc), Color of Life (Color of Life Community Resource & Activity Center), JumpBunch (CSCRM, Inc.), Mad Science of Houston (Little Scientists Inc.), and Young Picassos Houston for the period of 08/15/2021 through 08/14/2022. 887
3. **Approval of Contract Renewal option for job no. 19/050IA - Contracted Services for the Teaching Learning Center with the following vendor:** PrepForward, for the period of 9/01/2021 through 8/31/2022. 894
4. **Approval of Contract Renewal option for job no. 20/044KJ for Workers' Compensation Insurance for HCDE through the Texas Association of School Boards (TASB) Risk Management Fund** (fully insured product) for the period of 09/01/2021 through 08/31/2022 and the contract with TASB Risk Management Fund for the period of 09/01/2021 through 08/31/2022 in the amount of \$395,211.00. 896
5. **Approval of Contract Award for job no. 21/051KJ for Depository Banking Services** for HCDE with the following proposer: J.P. Morgan Chase Bank for the period of 09/01/2021 through 08/31/2023. 904

6. **Consideration and Approval of Contract Award for vendors for job no.21/052KJ Bond Counsel Services for HCDE's Public Facility Corporation as follows:** (1) approval of a pool of vendors for job no. 21/052KJ for the period of 07/21/2021 through 07/20/2026 consisting of the following vendors Orrick, Herrington & Sutcliffe, Escamilla & Poneck, LLP, Hardwick Law Firm, LLC, and Hunton Andrews Kurth LLP; and (2) approval of a resolution authorizing Orrick, Herrington & Sutcliffe LLP to serve as HCDE and HCDE PFC's Primary Bond Counsel and the remaining firms as Secondary Bond Counsel, subject to annual appropriations of funding. 929
7. **Approval of Contract Award for pool of vendors for job no. 21/053KJ Financial Advisory Services for Harris County Department of Education and HCDE's Public Facility Corporation with the following proposer(s):** U.S. Capital Advisors, LLC, Estrada Hinojosa & Company, Inc., Hilltop Securities, Inc., Masterson Advisors, LLC, Stifel, Nicolaus & Company, Inc., and Tijerina Galvan Lawrence, LLC, for the period of 07/21/2021 through 07/20/2026, and approval of U.S. Capital Advisors, LLC to serve as HCDE and HCDE PFC's Primary Financial Advisor and the remaining firms as Secondary Financial Advisors, subject to annual appropriations of funding. 953
8. **Approval of Contract Award for job no. 21/056YR Short Term Vocational Training Programs for Harris County Department of Education Adult Education Division with the following proposer(s):** Dellahniia; FocalPointK12, Inc.; Fuel Up For Life Foundation, Inc.; I'm Changing The Narrative, Inc.; Konnecting the Dots Developmental Institute; Launch Point CDC, Inc.; and U-Bridge Project Consulting Services for the period of 07/21/2021 through 07/20/2026, subject to annual appropriations of funding. 976
9. **Approval to amend CH Local 2021 allowable maximum contract amount** for SOA Fin 1st, (job no. 20/019KJ) for a total amount of \$80,000. 993
9. **ACTION ITEMS - NON-CONSENSUS**
- A. **Consider adoption of the Harris County Department of Education FY 2021-2022 Proposed Annual Budget totaling Out Flows for \$154,234,536; \$62,390,032 for the General Fund, \$48,233,919 for the Special Revenue Fund, \$4,446,773 for the Debt Service Fund, \$26,299,942 for the Capital Projects Fund, \$6,200,490 for the Internal Service Fund, and \$6,663,380 for the Enterprise Fund. The adoption of this budget also incorporates the 2021-2022 proposed salary increases and schedules.** 994
- B. **Consider approval of estimated reserved fund balances for non-spendable, restricted, committed assigned and unassigned** under the Governmental Accounting Standards Board (GASB) 54. (This is an annual requirement to project our end of the year fund balance to meet GASB accounting standards. Once the audit is completed, the final fund balances will be reported at the January Board Meeting). 1047
- C. **Consider first reading of the following revised local policies:** 1049
- a. CH(Local)
  - b. CQB(Local)
  - c. CV(Local)
  - d. DCD(Local)
  - e. DCE(Local)
  - f. DEC (Local)
  - g. FFAC(Local)
  - h. GKA(Local)

- D. **Consider approval of Memorandum of Understanding between HCDE and the Education Foundation of Harris County for the Partners in Education Project**, providing \$400,000 for grants, scholarships, and sponsorship activities (plus approximately \$35,000 in rollover funds from FY2021), and the Tools for Teachers Program, providing \$200,000 for educators' supplies, for a term of July 22, 2021 through August 31, 2022. 1083
- E. **Consider the approval for Change Order #2 in the amount of \$4,384.53 to the Nash Industries contract for renovations to the existing La Porte Head Start Campus.** (Funds to be used from Head Start budget are \$3,189.73 and the remaining \$1,194.80 will be deducted from the architect's fee.) 1084
- F. **Consider approval of HCDE Early Head Start Child Care Partnerships (EHS-CCP) contracts with the following vendors:** Community Partners Early Childhood Development Center (RFP 21/029IA) in the amount of \$117,000 and Successful Starters Learning Academy II (RFP 21/029IA) in the amount of \$117,000. Each contract will be valid 08/01/2021 through 08/31/2022 (Fully funded by the Head Start/Early Head Start grants). 1101
- G. **Consider approval of consent to assignment of contract(s) by Trusted Capital Group to HUB International Limited (Vendor is part of the cafeteria plan and 401a and 403b administrator).** 1124
10. **EXECUTIVE SESSION** Under the Texas Government Code pursuant to any and all purposes permitted by Sections 551.001-551.084, including, but not limited to: 551.071; 551.074
- A. **Deliberate** the appointment, employment, evaluation, reassignment, duties, discipline and/or dismissal of HCDE employees.
- B. **Deliberate** the purchase, exchange, sale and/or value of real property(ies) and obtain legal advice regarding same.
11. **RECONVENE** for possible action on items discussed in executive session
12. **Discussion and possible action regarding future agenda items**
13. **INFORMATION ITEMS** 1128
- A. **HR Information Items** 1130
- B. **Employee Count** 1131
- C. **Notice to board members of federal interest relating to Coolwood Head Start** 1132
- D. **The CASE for Kids Division awards three school districts and two charter school systems (aggregate amount \$550,700)**for delivery of comprehensive programs for the 2020-2021 school year: Alief ISD, Houston ISD, Pasadena ISD, Academy of Accelerated Learning Charter and Rhodes Performing Arts Charter. 1136
- E. **The CASE for Kids Division awards 43 nonprofit organizations (aggregate amount \$625,000), for delivery of comprehensive programs**, short-term projects and online college and career readiness programs to serve youth across four Harris County Precints for Summer of 2021. 1138



F. **A correction has been made to item 6.E.7. from the June 16, 2021 board meeting. Some of the job numbers did not match the vendors. The erroneous item read:** Consider approval of Contract Renewal option for job no. 20/032KN for Instructional Resources, Textbooks & Related Items with the following vendors: ABDO Publishing Company dba ABDO-Spotlight-Magic Wagon (#20/032KN-01); Barnes & Noble Booksellers, Inc. (#20/032KN-02); Complete Book and Media Supply, LLC (#20/032KN-07); Express Booksellers, LLC dba Express Booksellers (#20/032KN-08); Hipeware Labs, Inc. (#20/032KN-10); Houston A+ Challenge (#20/032KN-11); MT Library Services, Inc. dba Junior Library Guild (#20/032KN-12); KAMICO Instructional Media, Inc. (#20/032KN-13); Peoples Education, Inc. dba Mastery Education (#20/032KN-14); Newsela (#20/032KN-15); Hertzberg-New Method, Inc. dba Perma-Bound Books (#20/032KN-17); Rethink Autism (#20/032KN-20); Leticia Smith dba Risas y Sonrisas, LLC (#20/032KN-21); Scholastic, Inc. (#20/032KN-22); Waterford Institute dba Waterford Research Institute (#20/032KN-25), and X-CAL Corp (#20/032KN-26) for the period 07/15/2021 through 07/14/2022.

**The item should read and has been corrected in the June 16, 2021 meeting minutes as follows:** Consider approval of Contract Renewal option for job no. 20/032KN for Instructional Resources, Textbooks & Related Items with the following vendors: ABDO Publishing Company dba ABDO-Spotlight-Magic Wagon (#20/032KN-01); Barnes & Noble Booksellers, Inc. (#20/032KN-03); Complete Book and Media Supply, LLC (#20/032KN-08); Express Booksellers, LLC dba Express Booksellers (#20/032KN-09); *Hiperware* Labs, Inc. (#20/032KN-11); Houston A+ Challenge (#20/032KN-12); MT Library Services, Inc. dba Junior Library Guild (#20/032KN-13); KAMICO Instructional Media, Inc. (#20/032KN-14); Peoples Education, *Inc.* dba Mastery Education (#20/032KN-17); Newsela, *Inc* (#20/032KN-15); Hertzberg-New Method, Inc. dba Perma-Bound Books (#20/032KN-18); Rethink Autism, *Inc.* (#20/032KN-20); Leticia Smith dba Risas y Sonrisas, *L.L.C.* (#20/032KN-21); Scholastic, Inc. (#20/032KN-22); Waterford Institute dba Waterford Research Institute (#20/032KN-25), and X-CAL Corp (#20/032KN-26) for the period 07/15/2021 through 07/14/2022.

14. **ADJOURN** - Next regular meeting is scheduled for Wednesday, August 18, 2021, Board Room, 6300 Irvington Blvd., Houston, Texas, 77022, at 1:00 p.m.



James Colbert, Jr.  
County School Superintendent

# Public Hearing

# FY 2021-2022 Annual Budget Summary

## **July 21, 2021 Budget Workshop**

Submitted to Board of Trustees  
by  
James Colbert, Jr. Superintendent

Dr. Jesus J. Amezcua, CPA, RTSBA  
Assistant Supt. For Business Services

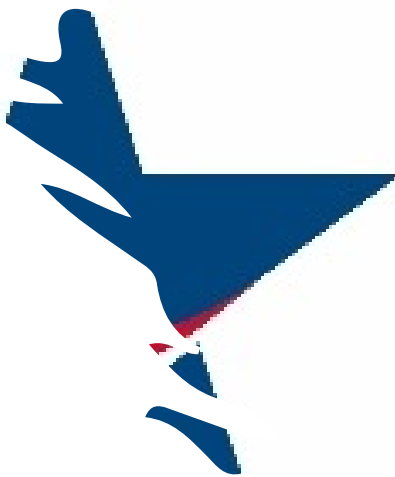

# Harris County Department Education

# Agenda

1. Introduction
2. Superintendent's Overview
3. Annual Budget Overview FY 21-22
4. Development Plans Overview
  1. \$15/hr Min Wage Update
  2. Capital Improvements Plan Phase I
  3. Capital Improvement Plan Phase II
5. Next Steps
6. Adjourn



# Goals Planning Cycle

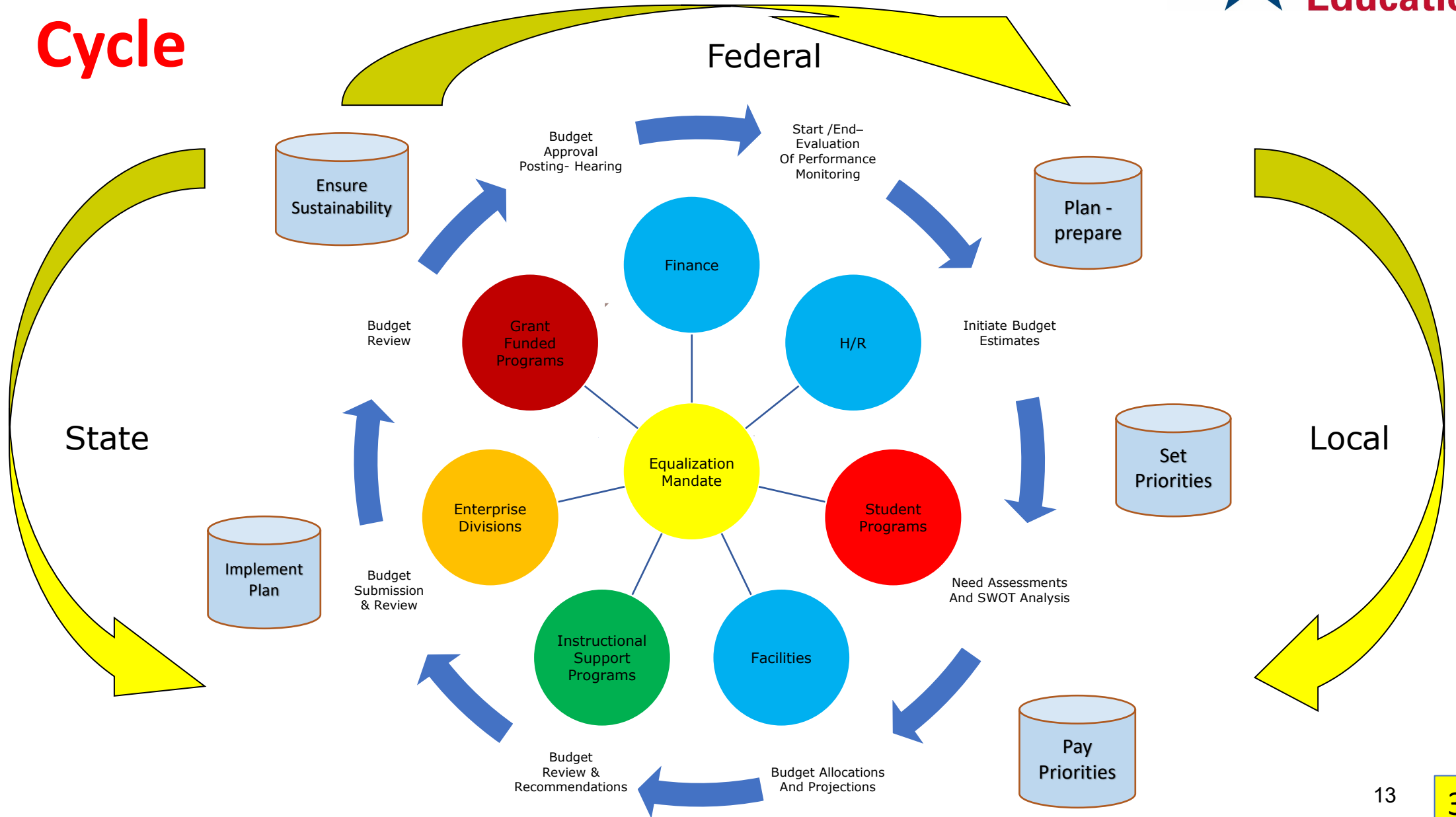

## General Fund

\$62.3 M 446.98 Total FTE



47%

## Special Revenue Fund Grants

\$48.2M 395.32 Total FTE



32%

## Debt Service Fund - Bonds

\$4.4 Total FTE - None



2%

# \$154,234,536 TOTAL BUDGET

### FY 21- 22

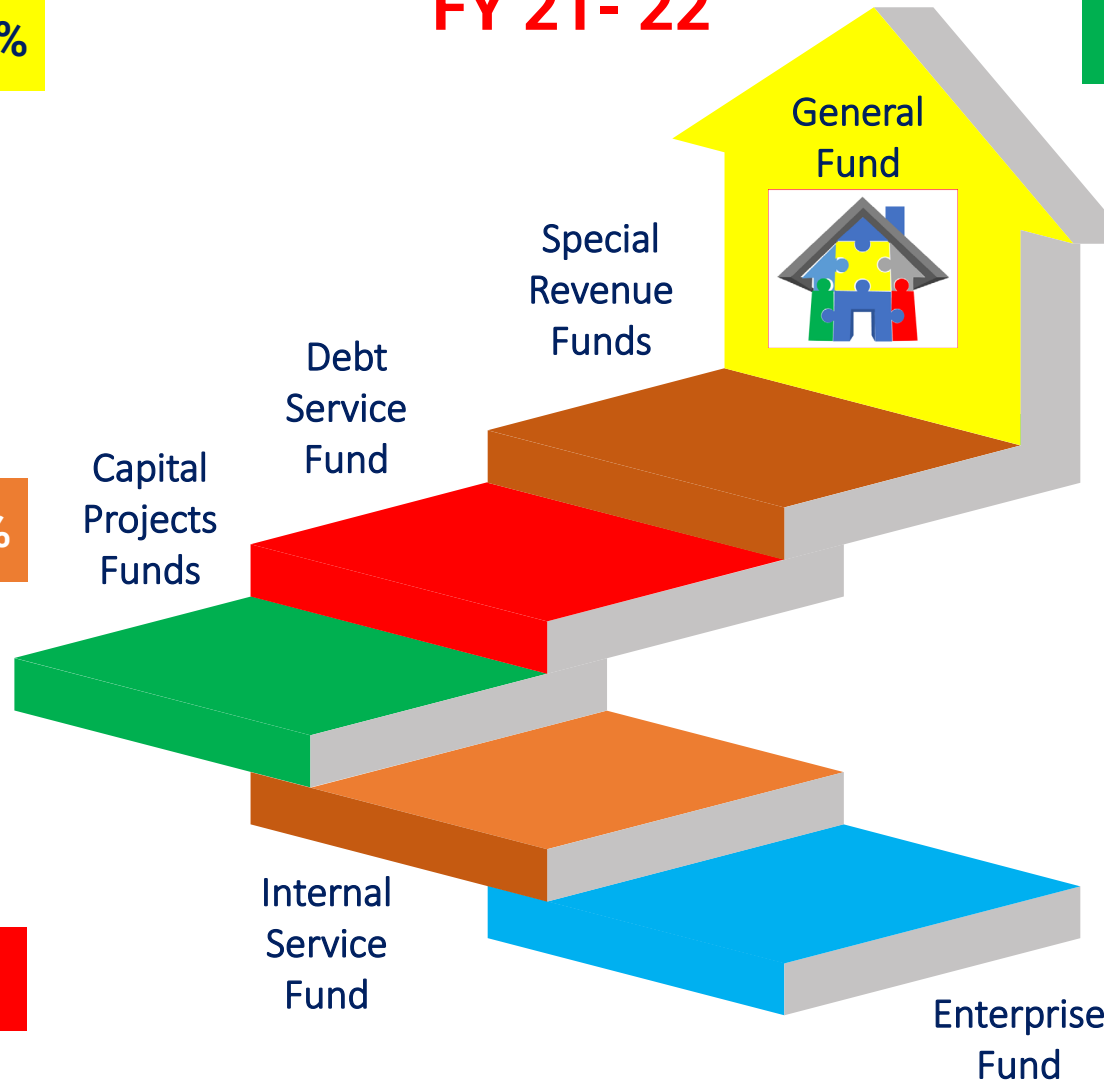

## Capital Projects Fund

\$26.3 M Total FTE - None  
AB East, Adult-Ed and HP East



11%

## Internal Service Fund - Facilities

\$6.2 M 49 Total FTE



4%

## Enterprise Fund

\$6.6 M  
18.37 Total FTE  
Choice Partners  
Cooperative.



4%

4

# What is in the **OUTFLOWS** Budget?

## NEW

- |   |           |                      |
|---|-----------|----------------------|
| 1. \$15 Minimum Wage increase & Equity  | \$750,000 |                      |
| 2. NEW \$2% and teacher salary increase | \$782,858 | Total of \$1,532,858 |
| NEW Teacher Salary at \$62,800          |           |                      |
| 3. NEW 1.5 Music Therapy positions      | \$133,254 |                      |

## CONTINUING

4. \$1,000,000 Ad Campaign
5. Adjusted Revenues for various divisions due to COVID19 (TLC, CSSS, Special Schools)
6. Maintained 2020 Level of other expenditures and adjusted based on trend
7. ONE TIME on Leave Retirement Payments \$150,000
8. \$300,000 for Head Start Support for \$15 Min. Wage Plan and \$300,000 Barrett Station
9. \$4.4 M payment for Debt Service
10. \$35,000 for Wellness Program

## ONE TIME

11. \$380,000 for IT infrastructure
12. \$320,087 Star reimagined
13. \$385,000 and \$15,000 Education Foundation
14. Maintenance Projects Conference Center \$741,000 not in CIP

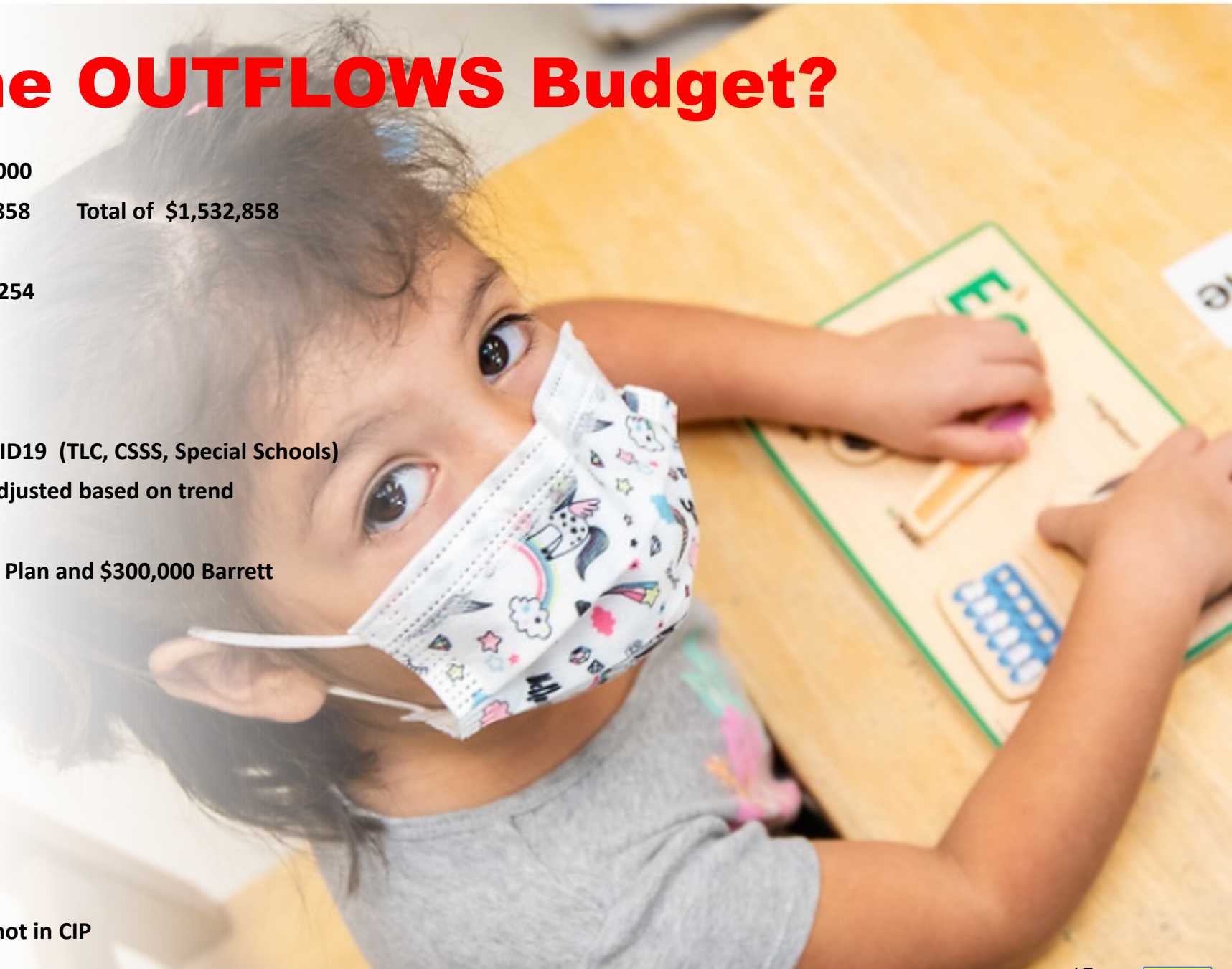

# Investing in our teacher, classroom and support staff workforce

**General Fund Support staff**  
\$15 minimum starting salary



**Head Start Fund Support staff**  
\$15 minimum starting salary

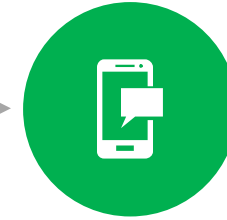

**Special Schools Teacher Salary**  
Increase 2% for teachers



**Other Staff**

**Salaries**  
2% salary increase to maintain compensation plan competitiveness.

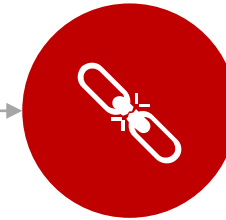

**Total Cost \$1,532,878**



# What is in the INFLOWS Budget?

## Assumptions:

- \$525 Billion in property Values
- Current tax rate At  $.004993/\$100$   
Depending on TNT Calculations
- Collection Rate of 99%
- Choice Increases Revenues
- Grants continuing (Head Start, CASE, Adult Ed)
- No change in Worker's Comp. Rates
- No Increase in Internal Services Rates

# General Fund Revenues Inflows

**FY 21-22**

**\$59,188,729**

## Fees for Services

Client based revenues such as therapy fees, Special Schools fees, training fees, audit services fees, etc.

**\$22,145,627**

**37%**

**6%**

## State Funding

TRS On behalf and state aid from salary and health insurance grants

**\$3,620,000**

**\$1,703,971 increase from \$57,484,758**  
Or **2.9% Increase**

## Property Tax Revenues

Taxes based on \$450 Billion in value at \$.005167 est. rate. & delinquent taxes

**\$26,528,250**

**45%**

**.1%**

## Other

Miscellaneous and Interest Costs

**\$50,000**

## Indirect Costs

Indirect cost from grants

**\$2,790,440**

**5%**

**7%**

## Transfers IN –Choice

Transfer in from Choice Partners Coop

**\$4,054,412**



# General Fund Expenditures

## \$62,390,032

### Outflows FY 21-22

\$6,947,126 decrease from \$69,337,158

Or 10% Decrease due to one-time costs



### Payroll

**\$40,760,751**

6100 Accounts – Payments for employee salaries and benefits.



### Contracted Services

**\$5,200,800**

6200 Accounts – Payments to vendors and contractors.



### Supplies & Materials

**\$2,761,188**

6300 Accounts - Payments for Supplies.



### Misc. Operating Cost incl. travel

**\$8,178,205**

6400 Accounts – Payments for other costs and travel.



### Capital Outlay

**\$40,000**

6600 Accounts – Payments for capitalized assets.



### Transfers Out

**\$5,449,088**

6600 Transfers to other funds debt service and grants.

65.4%

8.3%

4.4%

13%

.019%

8.8%

# Transfers out to other Funds

Outstanding Debt is \$52,054,285 To include 2014, 2015, 2016 & 2020 PFC and 2009A and 2020 Maintenance Notes

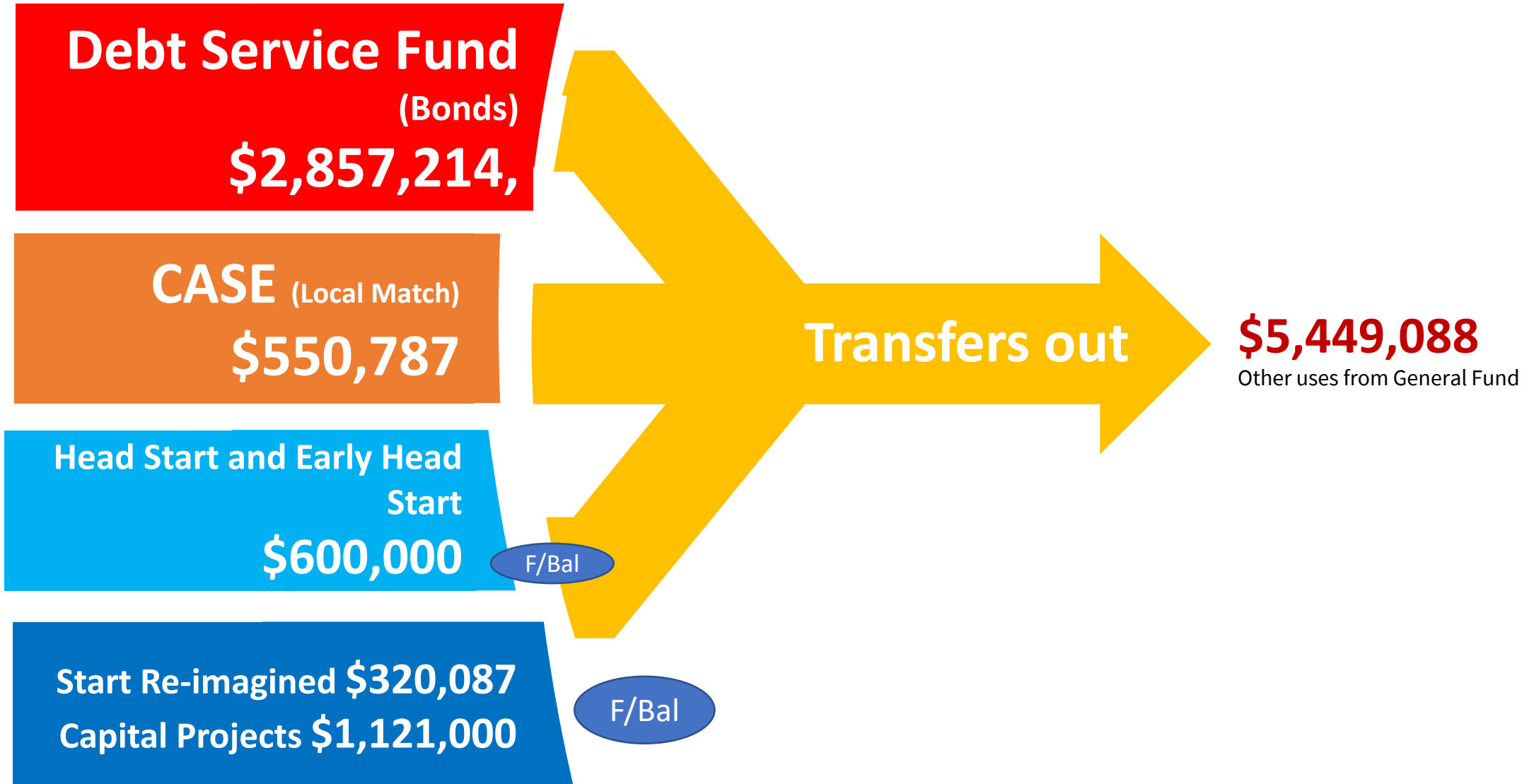

# 7.5 New Positions

## Therapy – 1.5 FTEs

One and half Music therapist to cover additional demand from ISDs.



## Head Start - 2 FTE

Instructional Coaches.

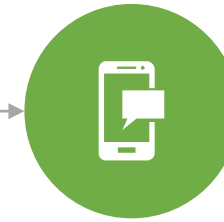

## Adult Ed Grant 4 FTE

Instructional Coach, Program Coordinator, Tester and Part time Program Assistant



**All positions are tied to revenue enhancement or grant funded.**

# Planned Use of Fund Balance for Capital Expenditures

FY 21-22

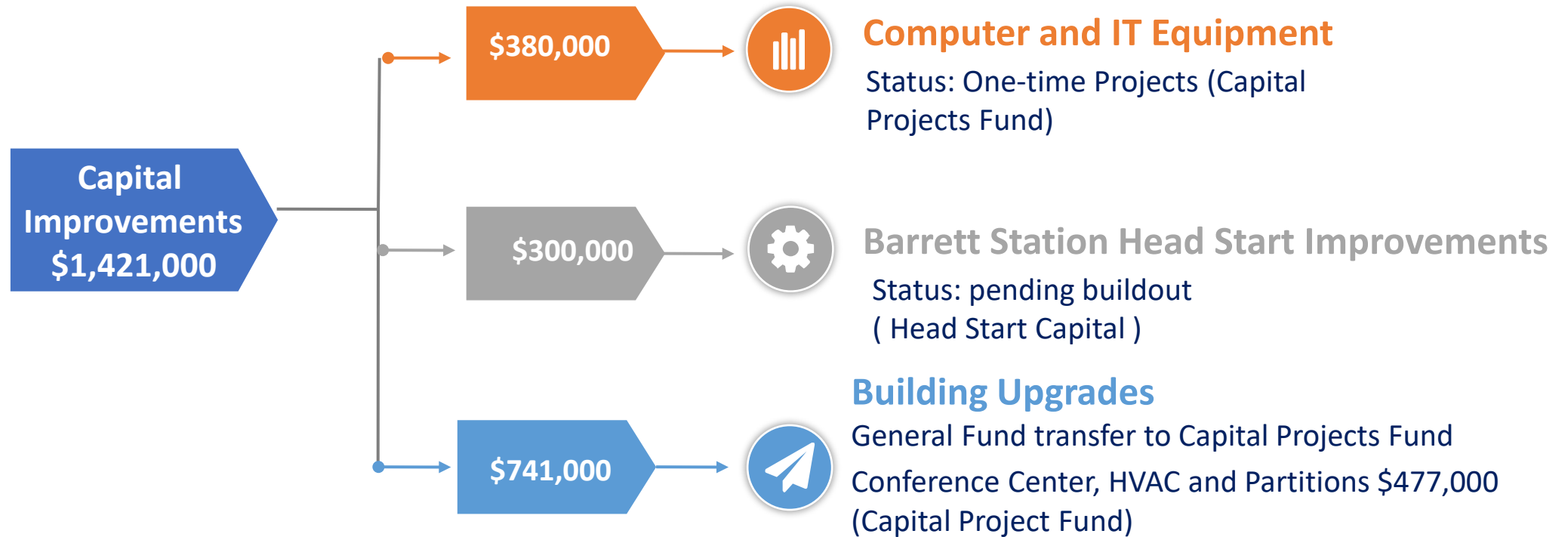

# Capital Improvement Plan Phase 1

Design  
Development  
Phase

01

## Adult ED Center

Construction of a 60,000 sq. ft facility to provide adult ed classes and programs.



02

## Irvington Remodel

Rehabilitation and remodeling of a 40,000 building.



Schematic  
Phase

03

## HP East Middle School

Construction of a 40,000 sq. ft facility to provide services to middle school students in Harris County.



Design  
Development  
Phase

04

## AB East School

Construction of a 40,000 sq. ft facility to provide instructional services to special ed students in Harris County.



Procurement  
Phase

# Capital Improvement Plan Phase 2

\$15 Million

01

## Equine Center

\$4,000,000 to \$6,000,000 PFC  
Construction of a 10,000 sq. ft  
facility to provide equine  
programs

02

## Workforce Development

Acquisition and development  
of industry programs  
\$4,000,000 PFC

03

## Maintenance Projects

\$3,000,000 M-Note  
Roof Repairs and maintenance  
projects

04

## Technology Projects

\$2,000,000 M-Note  
5-yr Infrastructure needs

Note: It will require a tax increase to finance new facilities and fund operating costs.



# Total Grants

## \$48,233,919



**\$5,912,173**

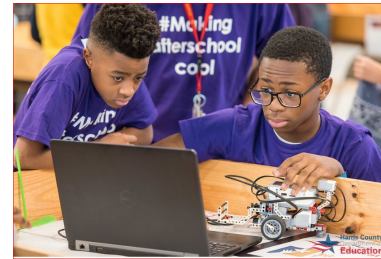

### Early Head Start

**Federal Grant – Health & Human Services**  
**Federal Grant –Incl. Matching**  
**\$8,499,892**

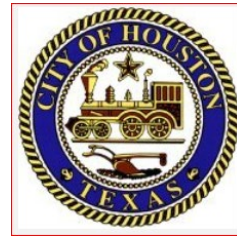

**Local & Federal Grants**  
**\$561,068**



### CASE

**21 Century Grant- US Dept. of ED. Workforce Development – HGAC, COH, H-Endowment Federal Grant**



**Head Start Federal Grant – Health & Human Services**  
**Federal Grant – Incl. Matching**  
**\$29,413,140**



**Adult Ed.**  
**\$3,847,646**  
**US Dept. of ED- HGAC Federal-State Grant**



Note: Includes One-time Covid 19 and construction funds.

# Property Values Growth

Last SEVEN Fiscal Years

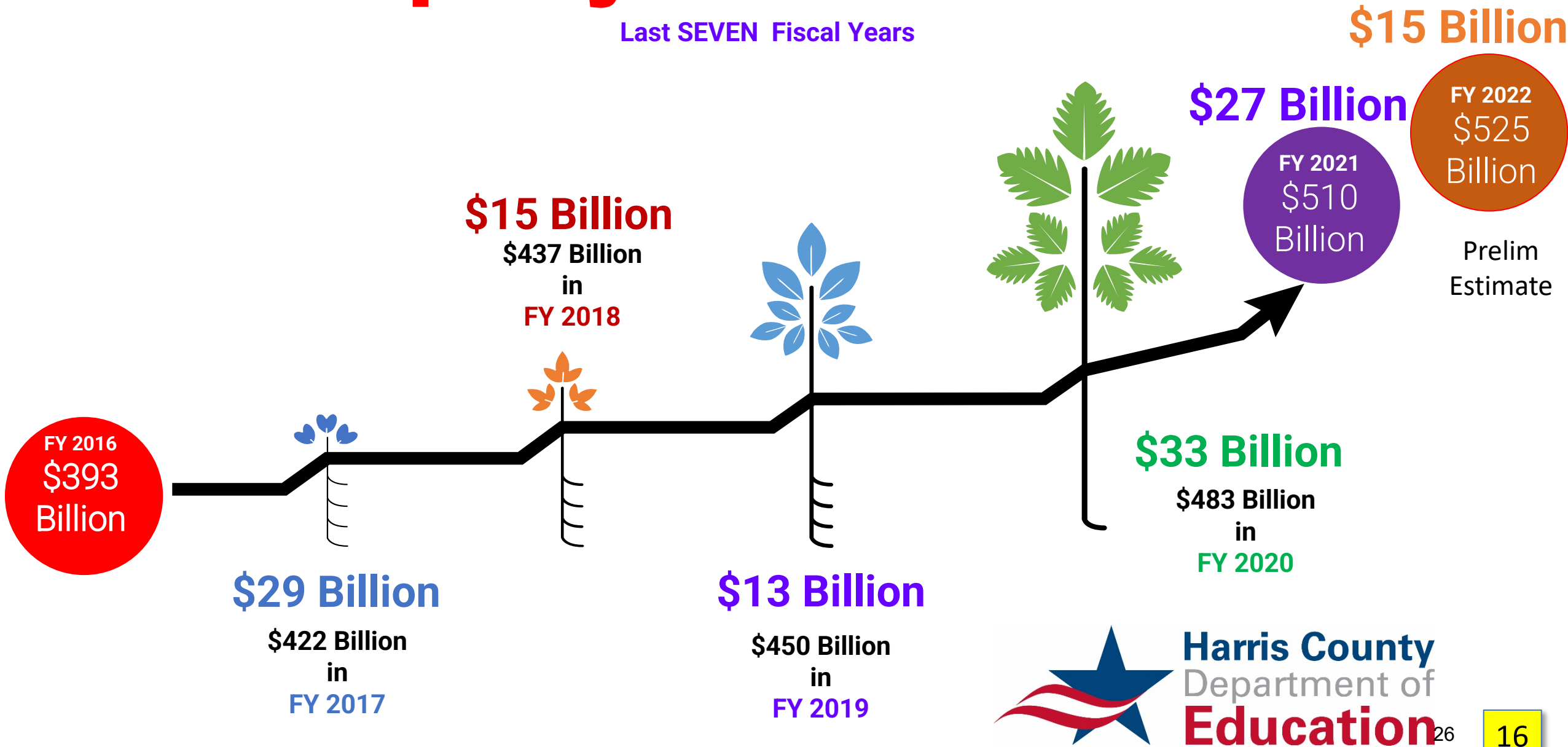

**Harris County**  
Department of  
**Education**<sup>26</sup>

**Harris County  
2021 Certified Estimate of Taxable Value**



<b>Major Property Category</b>	<b>2020 Taxable Value</b>	<b>Percent Change</b>	<b>Projected 2021 Taxable Value</b>
Residential & Rural Improved	204,425,683,146	5.53%	215,720,508,778
Apartments	52,793,515,398	1.13%	53,388,659,337
Commercial	129,400,699,448	1.05%	130,765,537,797
Vacant Land	13,274,442,116	-1.21%	13,113,218,707
Industrial	34,470,458,936	-1.60%	33,920,069,118
Utility	6,093,555,068	5.83%	6,448,961,667
Commercial Personal	31,602,783,812	-1.86%	31,015,509,280
Industrial Personal	30,774,112,002	-7.15%	28,575,301,699
All Other Property	675,639,601	-1.00%	668,883,205



<b>Projected 2021 Taxable Value</b>	<b>503,510,889,527</b>	<b>2.01%</b>	<b>513,616,649,590</b>
-------------------------------------	------------------------	--------------	------------------------

**Projected 2021 Taxable Value Range**

<b>Accuracy +/- 5%</b>	<b>487,935,817,110</b>	<b>To</b>	<b>539,297,482,069</b>
------------------------	------------------------	-----------	------------------------

# Property Tax Rate \$.01 Maximum

Six Year History

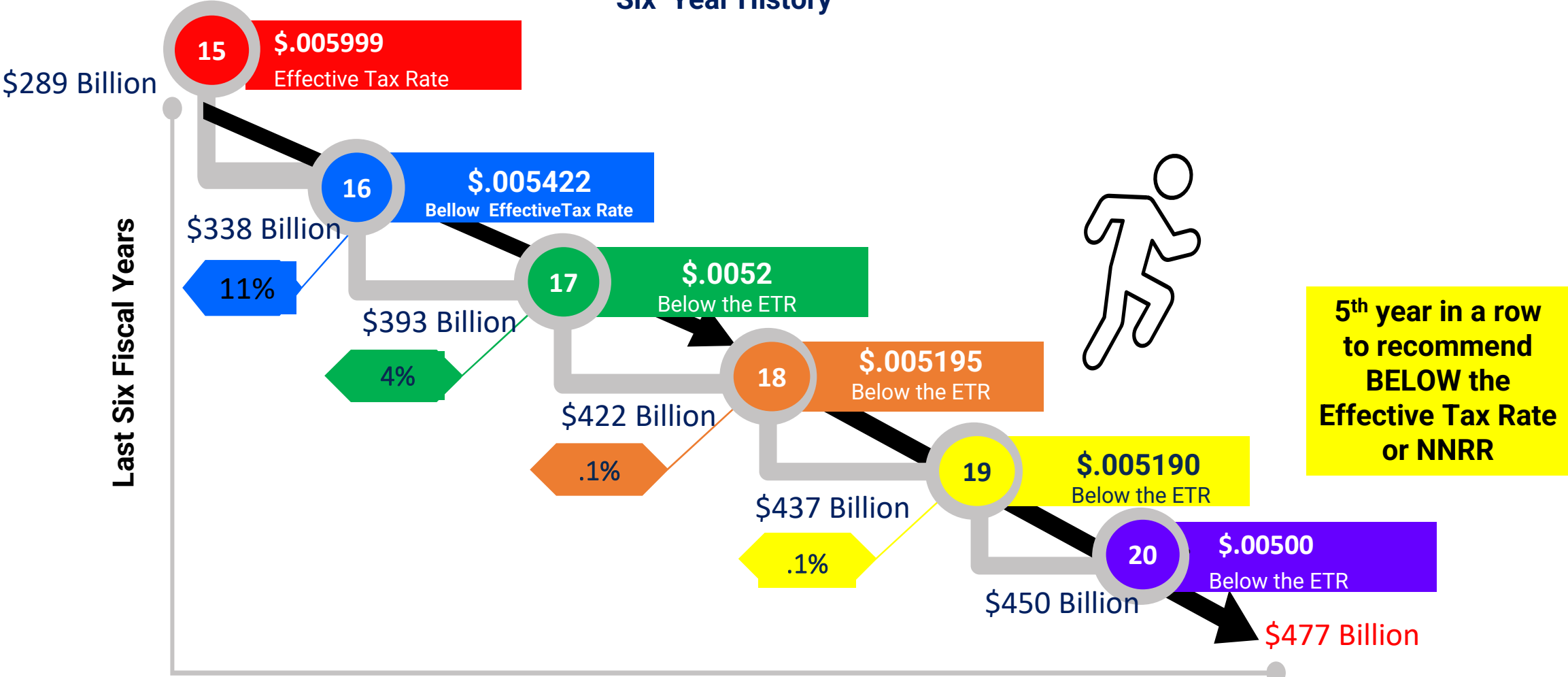

Lowering the tax rate

# Property Tax Rate \$.01 Maximum

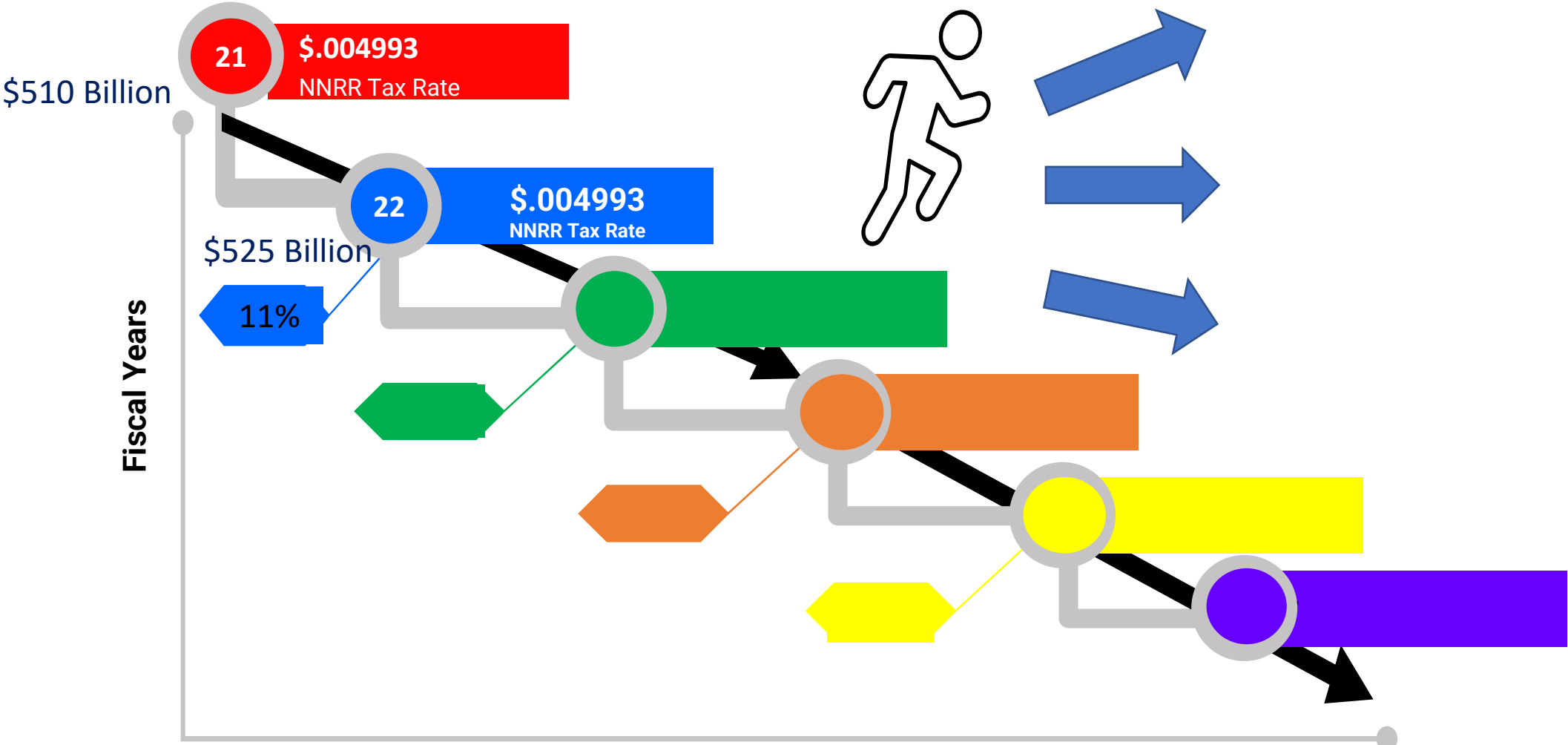

Lowering the tax rate



# Estimated Tax Rate

Harris County Department of Education Comparative Analysis of Property Values	DRAFT # 1		Estimated	What if scenario?
			Projected in Budget	If at 8% Max ESTIMATED
	A	B		
	FY 2021 Adopted	CURRENT FY 2021	PROJ At \$525 B	Including NEW Improvements Estimated TAX RATE
	<b>ADOPTED TAX RATE</b>	<b>ADOPTED TAX RATE</b>	Including NEW Improvements <b>Estimated TAX RATE</b>	Including NEW Improvements <b>Estimated TAX RATE</b>
Proposed Collections Tax Year 2021	<b>0.004993</b>	<b>0.004993</b>	<b>0.004993</b>	<b>0.005392</b>
Certified Taxable Value per HCAD *	\$ 392,595,710,238	\$ 392,595,710,238	\$ 525,000,000,000	\$ 525,000,000,000
Values under protest or not certified	118,420,401,768	118,420,401,768	-	-
	<b>511,016,112,006</b>	<b>511,016,112,006</b>	<b>525,000,000,000</b>	<b>525,000,000,000</b>
/ Rate per Taxable \$100	5,110,161,120	5,110,161,120	5,250,000,000	5,250,000,000
X Tax Rate	25,515,034	25,515,034	26,213,250	28,308,000
	98.07%	99%	100.00%	100.00%
X Estimated collection rate	<b>25,022,594</b>	<b>25,022,594</b>	<b>26,213,250</b>	<b>28,081,536</b>
	<b>\$ 25,022,594</b>	<b>\$ 25,022,594</b>	<b>\$ 26,213,250</b>	<b>\$ 28,081,536</b>
+Delinquent Tax Collections	-	-	-	-
+Special Assessments	15,000	15,000	15,000	15,000
+ Penalty & Interest	150,000	150,000	300,000	300,000
<b>Estimated Current Tax Available for Operations:</b>	<b>\$ 25,187,594</b>	<b>\$ 25,187,594</b>	<b>\$ 26,528,250</b>	<b>\$ 28,396,536</b>
		Difference from FY 21	\$ 1,505,656	\$ 1,868,286
	\$ 25,022,594	FY 20-21 Budget		
	\$ 23,606,834	FY 19-20 Budget		
	\$ 26,528,250	New Proposed FY 21-22 Budget		No New Revenue Rate <b>TBD</b>
	\$ 1,505,656	Total new money		Voter Approved Rate <8% <b>TBD</b>

# Estimated Fund Balance

## \$17,920,191

**FY 21-22**  
**Projected**

\$57,623,191 G/Fund  
/\$10,228,884  
= 17.75%

Or 2.13 Months



**Non-Spendable \$177,243**

shall mean that portion of the gross fund balance that is not expendable (such as inventories) or is legally earmarked for a specific use such as the self-funded reserves program.



**Restricted \$0**

includes amounts constrained to a specific purpose by the provider, such as grantor.



**Committed \$2,014,976**

shall mean that portion of the fund balance that is constrained to a specific purpose by the Board of Trustees.



**Assigned \$5,499,088**

shall mean that portion of the fund balance that is spendable or available for appropriation but has been tentatively earmarked for some specific purpose by the Board of Trustees and/or the Superintendent.



**Unassigned \$10,229,884**

includes amounts available for any legal purpose.

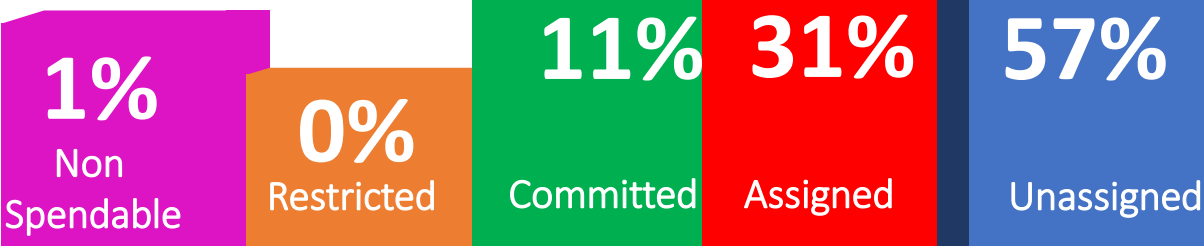
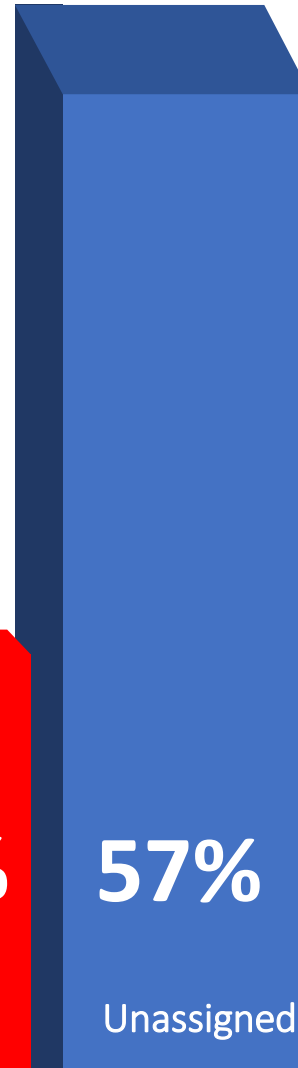

## Next Steps



# Harris County Department of **Education**

- Board Review – June 15, 2021
- Board Workshop – June 30 or July 21, 2021
- Required Posting –Houston Chronicle – 10 days prior to board meeting
- **Target Budget Approval Date July 21, 2021**
- Target Date - Certified Value – August 25, 2021
- Target Potential Public Hearing – September 2021
- Target Date - Tax Date Approval Date – October 2021



# Presentations

**Regular Board Meeting**

**7.C.**

**Meeting Date:** July 21, 2021

**Title:** Announcement of Certificate of Achievement Award for CAFR by ASBO

**Submitted For:** Jesus Amezcua, Business Office

**Submitted By:** Jaime Martinez

**Recommended Action:** Accept

**HCDE Goal(s):** 2. Deliver value responsibly  
4. Provide cost savings by leveraging tax dollars

**Additional Resource Personnel:**

**Facilities/Technology Approval Needed?:** None

**Information**

**Posted Agenda Item:**

**Announcement of award from the Association of School Business Officials International (ASBO) for the HCDE 2020 Comprehensive Annual Financial Report (CAFR) - Jesus Amezcua, Assistant Superintendent for Business Services**

**Subject:**

**Award from the Association of School Business Officials International (ASBO) for the HCDE 2020 Comprehensive Annual Financial Report (CAFR) -**

**Rationale:**

**Harris County Department of Education has received ASBO’s Certificate of Excellence in Financial Reporting for the fiscal year ended 2020. This award represents a significant achievement and reflects your commitment to transparency and high-quality financial reporting.**

**Fiscal Impact**

**Attachments**

FY20 ASBO Award & Letter

**Form Review**

**Inbox**

Assistant Superintendent - Business  
Assistant Superintendent - Business  
Form Started By: Jaime Martinez  
Final Approval Date: 07/07/2021

**Reviewed By**

Venetia Baldwin  
Jesus Amezcua

**Date**

07/06/2021 09:58 AM  
07/07/2021 11:41 AM  
Started On: 07/01/2021 08:18 AM



ASSOCIATION OF  
SCHOOL BUSINESS OFFICIALS  
INTERNATIONAL

**The Certificate of Excellence in Financial Reporting  
is presented to**

## **Harris County Department of Education**

**for its Comprehensive Annual Financial Report  
for the Fiscal Year Ended August 31, 2020.**

The district report meets the criteria established for  
ASBO International's Certificate of Excellence.



A handwritten signature in black ink, reading 'W. Edward Chabal'.

W. Edward Chabal  
President

A handwritten signature in black ink, reading 'David J. Lewis'.

David J. Lewis  
Executive Director



July 1, 2021

Dr. Jesus Amezcua  
Assistant Superintendent for Business Services  
Harris County Department of Education  
6300 Irvington Boulevard  
Houston, TX 77022

Dear Dr. Amezcua:

Congratulations! On behalf of the Association of School Business Officials (ASBO) International, I am pleased to inform you that Harris County Department of Education has received ASBO's Certificate of Excellence in Financial Reporting for the fiscal year ended 2020. This award represents a significant achievement and reflects your commitment to transparency and high-quality financial reporting. We encourage you to use the [COE recipient's logo](#) to share your achievement in emails and marketing materials.

The Certificate of Excellence (COE) Review Team has provided their comments for the improvement of your Comprehensive Annual Financial Report. It is important to review the comments and address them before you prepare next year's report. Your district must include a copy of the original comments and the district's written responses to the comments in next year's application packet.

We hope you will use the attached press release to share this important achievement with your community. Your award certificate is also attached.

Congratulations to you and the members of your staff who worked so hard to earn the COE this year. We look forward to your continued participation in the COE program.

Sincerely,

A handwritten signature in black ink, appearing to read 'David J. Lewis'. The signature is fluid and cursive, with a large initial 'D' and 'L'.

David J. Lewis  
Executive Director



### **School District Awarded for Outstanding Financial Reporting**

Ashburn, VA – 2021 – The Association of School Business Officials International (ASBO) is pleased to award Harris County Department of Education the Certificate of Excellence in Financial Reporting (COE). ASBO International’s COE recognizes districts that have met the program’s high standards for financial reporting and transparency. The school district earned the Certificate of Excellence for its Comprehensive Annual Financial Report for the fiscal year ended 2020.

“The COE’s mission is to promote and recognize excellence in financial reporting,” ASBO International Executive Director David Lewis says. “The Comprehensive Annual Financial Report informs stakeholders about the financial and economic state of the district, making it an important communications tool for building trust and engaging with the school community.”

By participating in the COE program, school districts demonstrate their commitment to financial transparency. Applicants submit their report for review by a team of financial professionals who provide feedback to improve future documents. If the report meets the requirements of the program, it may receive the Certificate of Excellence. A district’s participation in the COE program can facilitate bond rating and continuing bond disclosure processes.

The COE is proudly sponsored by ASBO International Strategic Partner American Fidelity.

# # #

#### **About ASBO International**

Founded in 1910, the Association of School Business Officials International (ASBO) is a nonprofit organization that, through its members and affiliates, represents approximately 30,000 school business professionals worldwide. ASBO International is committed to providing programs, services, and a global network that promote the highest standards in school business. Its members support student achievement through effective resource management in various areas ranging from finance and operations to food services and transportation. Learn more at [asbointl.org](http://asbointl.org).

#### **About American Fidelity**

American Fidelity provides employer cost-savings solutions and supplemental insurance benefits to specific industries. Acting as an extension of the HR department, we educate, enroll, and support the development of robust, competitive insurance packages—all while ensuring seamless administration and employee satisfaction. As experts in employer benefit solutions, our salaried account managers deliver year-round support, help employers overcome benefit administrative challenges, and always offer a different perspective – a different opinion.

# Monthly Financial Report



Month: June 2021

**HARRIS COUNTY DEPARTMENT OF EDUCATION  
CERTIFICATION OF FINANCIAL STATEMENTS**

- I. Assistant Superintendent's Message (Highlights)
- II. Investment Report (Monthly Highlights)
- III. Investment Portfolio Report (Monthly Report)
- IV. Highlights of Financial Statements  
Donations Report Included in Highlights

Schedules

- 1 General Fund (100-199) Balance Sheet
- 2 Budget Summary - All Funds Combined
- 3 General Fund (100-199) Budget Summary Report
- 4 Special Revenue Funds (200-499) Budget Summary Report
- 5 Debt Service Fund (599) Budget Summary Report
- 6 Capital Project Fund Budget Summary Report
- 7 Choice Partners Fund (711) Budget Summary Report
- 8 Workers Comp. Fund (753) Budget Summary Report
- 9 Internal Service Fund (799) Budget Summary Report
- 10 Trust & Agency Funds (800-840) Budget Summary Report
- 11 Local Construction Fund 199, BM (087) Budget Summary Report
- 12 General Funds Detail By Division
- 13 Special Revenue Funds Detail By Division
- 14 Revenues Update-Customer Fees/Charges
- 15 Expenditures By Class Object Group-All Funds
- 16 Chart for Performance Measurement

We certify that the monthly financial statements are true, and correct to the best of our ability. We have reviewed the expenditures, revenues, and appropriations for accuracy and completeness in the general ledger for the month. Texas Education Agency's Financial Accountability System Resource Guide ("FASRG") Ver 15.0 has been followed to assure grant compliance.

/s/ Jesus J. Amezcua

Jesus J. Amezcua, CPA, Ph.D., Asst. Superintendent for Business Services

/s/ Stephanie Ritchie

Stephanie Ritchie, Senior Accountant

**HARRIS COUNTY DEPARTMENT OF EDUCATION**  
**INTERIM FINANCIAL REPORTS (Unaudited)**  
**GENERAL FUNDS 100-199 BALANCE SHEET**  
 Fiscal year to date: June 30, 2021

Schedule 1

	<u>ACTUAL</u>
<b><u>ASSETS</u></b>	
Cash and Temporary Investments	\$ 40,513,358
Property Taxes-Delinquent at September 1, 2020	983,358
Less: Allowances for Uncollectible Taxes	(19,667)
Due from Federal Agencies	-
Other Receivables	1,353,512
Inventories	188,750
Deferred Expenditures	-
Other Prepaid Items	34,606
<b>TOTAL ASSETS:</b>	<b>\$ 43,049,018</b>
<b><u>LIABILITIES</u></b>	
Accounts Payable	10,324
Bond Interest Payable	-
Due to Other Funds	-
Accrued Wages	-
Payroll Deductions	1,421,127
Due to Other Governments	7,641
Deferred Revenue	973,447
<b>TOTAL LIABILITIES:</b>	<b>\$ 2,412,539</b>
<b><u>FUND EQUITY</u></b>	
Unassigned Fund Balance	17,637,563
Non-Spendable Fund Balance	177,243
Restricted Fund Balance	-
Committed Fund Balance	2,014,976
Assigned Fund Balance	13,540,000
Excess(Deficiency) of Revenues & Other Resources Over(Under) Expenditures & Other Uses	7,801,016
<b>TOTAL FUND EQUITY:</b>	<b>\$ 41,170,798</b>
Fund Balance Appropriated Year-To-Date	(534,319)
<b>TOTAL LIABILITIES, FUND EQUITY, AND FUND BALANCE APPROPRIATED TO DATE:</b>	<b>\$ 43,049,018</b>

<b><u>Financial Strength Indicator: Working Capital</u></b>			
Total Current Assets	=	43,049,018	
			= <b>40,636,478</b>
- Total Current Liabilities		- 2,412,539	

<b><u>Efficient Leverage Indicator</u></b>			
Unassigned Fund Balance	=	17,637,563	
			= <b>43 %</b>
Total Fund Balance		40,636,479	



**HARRIS COUNTY DEPARTMENT OF EDUCATION**  
**INTERIM FINANCIAL REPORTS (Unaudited)**  
**BUDGET SUMMARY-ALL FUNDS COMBINED**  
 Fiscal year to date: June 30, 2021

	BUDGET	YTD REVENUES		VARIANCE	FY 20-21 % BUDGET REALIZED	FY 19-20 % BUDGET REALIZED
<b>REVENUES &amp; OTHER RESOURCES</b>						
* General Fund-1XX	\$ 58,117,402	\$ 49,932,924		\$(8,184,478)	86%	78%
Special Revenue Funds-2XX, 3XX, 4XX	51,922,374	19,284,239		(32,638,135)	37%	54%
Debt Service Fund-599	6,169,043	3,902,217		(2,266,826)	63%	97%
PFC Capital Projects Fund-698&699	54,148,047	46,463,008		(7,685,039)	86%	70%
Trust and Agency Funds-8XX	-	6,983		6,983	0%	0%
Choice Partners-711	5,228,380	5,785,518		557,138	111%	90%
Workers' Compensation Fund-753	475,000	294,131		(180,869)	62%	28%
Internal Service Fund-Facilities-799	5,806,832	4,455,990		(1,350,842)	77%	85%
<b>Total Revenues &amp; Other Resources:</b>	<b>181,867,078</b>	<b>130,125,011</b>		<b>(51,742,067)</b>	<b>72%</b>	<b>70%</b>
<b>EXPENDITURES &amp; OTHER USES</b>						
* General Fund-1XX	70,240,484	42,131,909	1,521,379	26,587,196	62%	78%
Special Revenue Funds-2XX, 3XX, 4XX	51,922,374	22,495,219	4,066,787	25,360,368	51%	54%
Debt Service Fund-599	6,169,043	3,815,312	-	2,353,731	62%	97%
PFC Capital Projects Fund-698&699	54,953,973	2,655,775	15,200,593	37,097,605	32%	70%
Trust and Agency Funds-8XX	-	1,550	1,250	(2,800)	0%	0%
Choice Partners-711	5,728,380	5,785,518	135,487	(192,625)	103%	90%
Workers' Compensation Fund-753	475,000	342,314	-	132,686	72%	28%
Internal Service Fund-Facilities-799	5,806,832	4,455,990	285,974	1,064,868	82%	85%
<b>Total Expenditures &amp; Other Uses:</b>	<b>195,296,086</b>	<b>81,683,587</b>	<b>21,211,471</b>	<b>92,401,029</b>	<b>53%</b>	<b>70%</b>
<b>Excess/(Deficiency) Estimated Revenues Over/(Under) Expenditures:</b>	<b>(13,429,008)</b>	<b>48,441,424</b>				
Beginning Fund Balance-September 1st:	38,637,221	38,637,221				
<b>Estimated Fund Balance:</b>	<b>\$ 25,208,213</b>	<b>\$ 87,078,645</b>				

\*General Fund includes one-time cost projects, such as construction, asset & building replacement costs and software purchase.

<b>Current Tax Revenue to Total Revenue Ratio Indicator:</b>			
Current Tax Revenue	=	24,806,413	= 19.1 %
Total Revenue		130,125,011	

**HARRIS COUNTY DEPARTMENT OF EDUCATION**  
**INTERIM FINANCIAL REPORTS (Unaudited)**  
**GENERAL FUNDS 100-199 BUDGET SUMMARY REPORT**  
 Fiscal year to date: June 30, 2021

	BUDGET	YTD REVENUES	VARIANCE	FY 20-21 % BUDGET REALIZED	FY 19-20 % BUDGET REALIZED
<b>REVENUES &amp; OTHER RESOURCES</b>					
<b>Revenues</b>					
Local Customer Fees/Charges	\$ 23,493,005	\$ 18,360,387	\$(5,132,618)	78%	86%
Local Property Tax Rev-Current	25,038,000	24,806,413	(231,587)	99%	97%
Local Property Tax Rev-Del, P&I	288,432	195,186	(93,246)	68%	47%
Local Investment Earnings	170,000	16,030	(153,970)	9%	79%
Local Grants Indirect Cost Rev	727	4,010	3,283	552%	0%
Local Grants	-	-	-	0%	0%
Local Miscellaneous Revenue	90,000	113,912	23,912	108%	141%
<b>Total Local:</b>	<b>49,080,164</b>	<b>43,495,938</b>	<b>(5,584,226)</b>	<b>89%</b>	<b>91%</b>
State FSP-Compensation	-	157,347	157,347	0%	55%
State TEA-State Health Insurance	-	319,462	319,462	0%	0%
State Indirect Cost	-	-	-	0%	0%
<b>Total State:</b>	<b>-</b>	<b>476,809</b>	<b>476,809</b>	<b>0%</b>	<b>149%</b>
Federal Grants Indirect Cost	2,597,787	1,505,226	(1,092,561)	58%	81%
<b>Total Revenues:</b>	<b>51,677,951</b>	<b>45,477,973</b>	<b>(6,199,978)</b>	<b>88%</b>	<b>91%</b>
<b>Other Resources</b>					
Insurance Recovery	512,211	302,570	(209,641)	59%	0%
Local HCTO Tax Collection Fees	-	-	-	0%	0%
State TRS Matching	3,000,000	-	(3,000,000)	0%	0%
Transfers In-Choice Partners	2,927,240	4,152,381	1,225,141	142%	117%
<b>Total Other Resources:</b>	<b>6,439,451</b>	<b>4,454,951</b>	<b>(1,984,500)</b>	<b>69%</b>	<b>54%</b>
<b>Total Revenues &amp; Other Resources:</b>	<b>58,117,402</b>	<b>49,932,924</b>	<b>(8,184,478)</b>	<b>86%</b>	<b>88%</b>

NOTE: A negative balance in the revenue variance column represents the amount pending to be collected as compared to the budget. A positive balance in the expenditure variance column represents the amount available to spend as compared to the budget.

<b><u>Indirect Cost to Tax Ratio Indicator:</u></b>				
Indirect Cost General Fund		1,509,236		
_____	=	_____	=	<b>3.0%</b>
Total General Fund Revenues		49,932,924		

**HARRIS COUNTY DEPARTMENT OF EDUCATION**  
**INTERIM FINANCIAL REPORTS (Unaudited)**  
**GENERAL FUNDS 100-199 BUDGET SUMMARY REPORT**  
 Fiscal year to date: June 30, 2021

	BUDGET	YTD EXPENDITURE	ENCUM- BRANCES	VARIANCE	FY 20-21 % BUDGET USED	FY 19-20 % BUDGET USED
<b>EXPENDITURES &amp; OTHER USES</b>						
<b>Expenditures</b>						
Adult Education-Local	\$ 176,707	\$ 133,446	\$ -	\$ 43,261	76%	73%
Educator Certification & Advancement	714,271	551,477	13,446	149,348	79%	76%
Assistant Superintendent-Academic Support	327,872	249,065	-	78,807	76%	79%
Asst Supt-Education and Enrichment	300,324	237,602	1,703	61,019	80%	68%
Board of Trustees	198,143	116,574	-	81,569	59%	64%
COVID-19 Disaster Recovery	-	-	-	-	0%	0%
Business Support Services	2,128,629	1,649,238	75,059	404,332	81%	83%
Center for Safe & Secure Schools	654,303	372,439	17,517	264,347	60%	77%
Communication	1,193,018	709,570	5,984	477,465	60%	67%
Client Engagement	541,869	362,963	3,281	175,625	68%	72%
Ctr A/S Summ & Exp Learn	770,280	421,895	119,707	228,678	70%	74%
Department-Wide	5,471,812	4,468,584	560,000	443,228	93%	85%
Education Foundation	211,079	8,244	-	202,835	4%	98%
Chief of Staff	281,956	231,372	-	50,584	82%	84%
Facilities						
Construction Services	221,859	136,562	-	85,297	62%	73%
Facilities Support Services	-	-	-	-	0%	0%
Local Construction Fund 170	-	-	-	-	0%	0%
Building Replacement Schedule	-	-	-	-	0%	13%
Records Management Services	2,059,390	1,458,723	31,425	569,242	72%	76%
Head Start-Local	8,000	-	-	8,000	0%	44%
Human Resources	1,100,020	852,743	47,798	199,480	82%	81%
The Teaching and Learning Center						
Bilingual Education	156,270	62,649	-	93,621	40%	63%
Digital Learning	-	-	-	-	0%	0%
Digital Education and Innovation	311,442	233,532	-	77,910	75%	86%
TLC (Division Wide)	315,754	137,883	8,697	169,174	46%	76%
Early Childhood Winter Conference	143,507	68,062	-	75,445	47%	83%
English Language Arts	195,038	117,141	4,200	73,697	62%	70%
Math	221,867	133,770	36,850	51,247	77%	72%
Professional Development	-	-	-	-	0%	0%
Science	101,526	42,400	-	59,126	42%	63%
Social Studies	53,522	28,629	-	24,893	53%	61%
Speaker Series	155,996	68,445	15,000	72,551	53%	70%
Special Education	80,508	63,499	-	17,009	79%	74%
Purchasing Support Services	689,239	455,956	15,491	217,792	68%	78%
QZAB & Maint Tax Notes FD	-	-	-	-	0%	0%
Research & Evaluation Institute	650,927	484,613	8,986	157,328	76%	79%
Texas Center for Grants Development	613,455	486,169	242	127,044	79%	81%

**HARRIS COUNTY DEPARTMENT OF EDUCATION**  
**INTERIM FINANCIAL REPORTS (Unaudited)**  
**GENERAL FUNDS 100-199 BUDGET SUMMARY REPORT**  
 Fiscal year to date: June 30, 2021

	BUDGET	YTD EXPENDITURE	ENCUM- BRANCES	VARIANCE	FY 20-21 % BUDGET USED	FY 19-20 % BUDGET USED
<b>EXPENDITURES &amp; OTHER USES</b>						
<b>Expenditures</b>						
Retirement Leave Benefits Fund	\$ 150,000	\$ 333,844	\$ -	\$(183,844)	223%	231%
Scholastic Arts	166,554	108,691	-	57,863	65%	74%
Special Schools & Services						
Academic and Behavior School East	4,864,948	3,202,942	54,621	1,607,386	67%	73%
Academic and Behavior School West	4,659,415	3,175,469	43,098	1,440,848	69%	74%
Fortis Academy	1,415,911	870,260	42,384	503,267	64%	79%
Highpoint East School	3,402,446	2,636,186	33,132	733,128	78%	78%
Special Schools Administration	972,597	624,195	96,647	251,755	74%	79%
Superintendent's Office	669,457	524,334	-	145,123	78%	80%
State TRS On Behalf Payments	3,000,000	-	-	3,000,000	0%	0%
Technology						
Chief Communications Officer	204,755	156,380	-	48,375	76%	79%
Technology Support Services	3,958,456	2,972,191	201,349	784,916	80%	75%
School Based Therapy Services	12,733,654	9,595,551	84,764	3,053,339	76%	77%
<b>Total Expenditures:</b>	<b>56,246,776</b>	<b>38,543,287</b>	<b>1,521,379</b>	<b>16,182,109</b>	<b>71%</b>	<b>73%</b>
<b>Other Uses</b>						
Transfers Out-Special Revenue Funds	550,787	-	-	550,787	0%	0%
Transfers Out-Head Start Fund 205	450,000	72,983	-	377,017	16%	15%
Transfers Out-Head Start La Porte	526,705	-	-	526,705	0%	0%
Transfers Out-Debt Service	6,469,042	3,164,984	-	3,304,058	49%	97%
Transfers Out-Department Wide	5,440,000	-	-	5,440,000	0%	41%
Transfers Out- Facilities	14,410	-	-	14,410	0%	9%
Transfers Out-Star Reimagined	542,764	350,654	-	192,110	65%	0%
<b>Total Other Uses:</b>	<b>13,993,708</b>	<b>3,588,621</b>	<b>-</b>	<b>10,405,087</b>	<b>27%</b>	<b>47%</b>
<b>Total Expenditures &amp; Other Uses:</b>	<b>70,240,484</b>	<b>42,131,909</b>	<b>1,521,379</b>	<b>26,587,196</b>	<b>63%</b>	<b>69%</b>
<b>Excess/(Deficiency) Estimated Revenues</b>						
<b>Over/(Under) Expenditures:</b>	<b>(12,123,082)</b>	<b>7,801,015</b>				
Beginning Fund Balance-September 1st:	32,839,094	32,839,094				
<b>Estimated Fund Balance:</b>	<b>\$ 20,716,012</b>	<b>\$ 40,640,109</b>				

<b>Financial Strength Indicator: Fund Balance to GF Expenditures</b>			
Unassigned Fund Balance		17,637,563	
	=		=
Total General Fund Expenditures		42,131,909	<b>41.86%</b>

**HARRIS COUNTY DEPARTMENT OF EDUCATION**  
**INTERIM FINANCIAL REPORTS (Unaudited)**  
**SPECIAL REVENUE FUNDS 200-499 BUDGET SUMMARY REPORT**  
 Fiscal year to date: June 30, 2021

Schedule 4 - SR Budget  
 Summary

	BUDGET	YTD REVENUES	VARIANCE	FY 20-21 % BUDGET REALIZED	FY 19-20 % BUDGET REALIZED	
<b>ESTIMATED REVENUES &amp; OTHER RESOURCES</b>						
<b>Estimated Revenues</b>						
Local Program Revenues	\$ 9,249,675	\$ 3,358,624	\$ 5,891,051	36%	64%	
State Program Revenues	-	-	-	0%	0%	
* Federal Program Revenues	41,186,722	15,501,978	25,684,744	38%	48%	
<b>Total Estimated Revenues:</b>	<b>50,436,397</b>	<b>18,860,602</b>	<b>31,575,795</b>	<b>37%</b>	<b>49%</b>	
<b>Other Resources</b>						
Transfer In-CASE After School Program	550,787	-	550,787	0%	0%	
Transfer In-Adult Ed	-	-	-	0%	0%	
Transfer In-HeadStart	450,000	72,983	377,017	16%	16%	
Transfer In-Star Reimagined	485,190	350,654	134,536	72%	0%	
<b>Total Other Resources:</b>	<b>1,485,977</b>	<b>423,637</b>	<b>1,062,340</b>	<b>29%</b>	<b>9%</b>	
<b>Total Estimated Revenues &amp; Other Resources:</b>	<b>\$ 51,922,374</b>	<b>\$ 19,284,239</b>	<b>\$ 32,638,135</b>	<b>37%</b>	<b>48%</b>	
	BUDGET	YTD EXPENDITURE	ENCUM- BRANCES	VARIANCE	FY 20-21 % BUDGET USED	FY 19-20 % BUDGET USED
<b>EXPENDITURES &amp; OTHER USES</b>						
<b>Adult Education Program</b>						
Fed Dist Learning 2210						0%
CDBG AEL Grant 2221	29,500	-	-	29,500	0%	0%
Fed TANF 2231	-	-	-	-	0%	0%
Fed TANF 2232						0%
Fed ABE Regular 2301	3,594,764	2,901,944	247,235	445,585	88%	0%
Fed ABE Regular 2302	-	-	-	-	0%	0%
Fed ABE EL/Civics 2341	466,425	82,644	3,958	379,824	19%	0%
Fed ABE EL/Civics 2342	-	-	-	-	0%	0%
State ABE Regular 3811	-	-	-	-	0%	0%
State ABE Regular 3812						0%
Loc AdultEd Grant - 4981	1,108	-	-	1,108	0%	0%
<b>Total Adult Education Program:</b>	<b>4,091,797</b>	<b>2,984,588</b>	<b>251,192</b>	<b>856,017</b>	<b>79%</b>	<b>0%</b>
<b>Center for Safe &amp; Secure Schools</b>						
STOP School Violence - 2100	120,299	8,062	-	112,237	7%	37%
STOP School Violence - 2101	261,271	121,656	28,500	111,114	57%	0%
STOP Grant In-Kind - 4910	45,562	1,308	-	44,254	3%	0%
STOP Grant In-Kind - 4911	98,712	10,658	-	88,054	11%	0%
JAMS Grant - 4641	40,000	25,142	-	14,858	63%	0%
JAMS Grant In-Kind - 4741	12,794	-	-	12,794	0%	0%
<b>Total Center for Safe &amp; Secure Schools:</b>	<b>578,638</b>	<b>166,827</b>	<b>28,500</b>	<b>383,311</b>	<b>34%</b>	<b>42%</b>
<b>Educator Certification and Advancement</b>						
Educators & Families for English Learners	20,000	6,500	-	13,500	33%	48%
<b>Total Educator Certification and Advancem</b>	<b>20,000</b>	<b>6,500</b>	<b>-</b>	<b>13,500</b>	<b>33%</b>	<b>48%</b>
<b>Schools</b>						
ABS East	-	-	-	-	0%	0%
ABS West	-	-	-	-	0%	99%
<b>Total Schools:</b>	<b>-</b>	<b>-</b>	<b>-</b>	<b>-</b>	<b>0%</b>	<b>99%</b>

\*Federal funding is the main source for special revenue grants. The \$41,186,722 Federal Program Revenues includes \$4,090,689 for Adult Education, \$6,494,932 for CASE, \$30,158,315 for Head Start, and \$442,786 for various other divisions.

**HARRIS COUNTY DEPARTMENT OF EDUCATION**  
**INTERIM FINANCIAL REPORTS (Unaudited)**  
**SPECIAL REVENUE FUNDS 200-499 BUDGET SUMMARY REPORT**  
 Fiscal year to date: June 30, 2021

Schedule 4 - SR Budget  
 Summary

	BUDGET	YTD EXPENDITURE	ENCUM- BRANCES	VARIANCE	FY 20-21 % BUDGET USED	FY 19-20 % BUDGET USED
<b>EXPENDITURES &amp; OTHER USES</b>						
<b>Disaster Recovery</b>						
COVID-19	\$ 749,807	\$ 391,975	\$ -	\$ 357,832	52%	11%
<b>Total Disaster Recovery:</b>	<b>749,807</b>	<b>391,975</b>	<b>-</b>	<b>357,832</b>	<b>52%</b>	<b>11%</b>
<b>Star Reimagined</b>						
Star Reimagined	485,190	350,654	77,530	57,006	91%	0%
<b>Total Star Reimagined:</b>	<b>485,190</b>	<b>350,654</b>	<b>77,530</b>	<b>57,006</b>	<b>91%</b>	
<b>The Center for Afterschool, Summer, and Expanded Learning</b>						
Fed/Local After School Partnership - 2880	885,975	864,929	16,354	4,692	99%	63%
Fed/Local After School Partnership - 2881	2,304,173	897,535	501,471	905,167	61%	0%
Fed 21st Century CLC-Cycle IX - 2670	437,298	143,948	-	293,350	33%	88%
Fed 21st Century CLC-Cycle IX - 2671	1,773,420	735,158	965,872	72,391	96%	0%
Fed 21st Century CLC-Cycle IX - 2680	169,366	69,465	-	99,901	41%	98%
Fed 21st Century CLC-Cycle X - 2681	1,475,487	754,603	691,315	29,569	98%	0%
County Connections - 4681	712,250	21,688	18,248	672,313	0%	85%
Loc Houston Endowment - 4631	173,250	-	3,700	169,550	2%	0%
Loc COH Connections Program - 4671	770,000	612,128	-	157,872	79%	0%
Loc Ecobot	4,321	2,128	-	2,193	96%	36%
<b>Total The Center for Afterschool, Summer,</b>	<b>8,705,540</b>	<b>4,101,582</b>	<b>2,196,960</b>	<b>2,406,998</b>	<b>78%</b>	<b>80%</b>
<b>Head Start</b>						
Fed Head Start - 2051	11,405,650	5,689,035	754,705	4,961,910	0%	108%
Fed Head Start Training Funds - 2061	114,079	24,595	28,403	61,081	56%	0%
Head Start Disaster Assistance - 2070	504,283	190,586	280,742	32,956	0%	92%
HS - Coolwood Construction - 2091 Fed	7,854,842	59,713	212,288	7,582,841	46%	0%
Early Head Start - Start Up - 2141 Fed	2,086,376	25,939	60,779	1,999,658	93%	16%
Early Head Start-Operations-2150 Fed	102,505	32,890	-	69,615	32%	85%
Early Head Start-Operations-2151 Fed	3,101,610	1,617,143	163,113	1,321,355	57%	0%
Early Head Start-T&TA-2160	13,183	-	-	13,183	0%	88%
Fed Early Head Start-T&TA-2161	71,339	30,121	5,008	36,210	49%	0%
HS - Coolwood Land Acquisition - 2181	587,215	6,287	-	580,928	91%	4%
Fed Head Start Op & Training - 2890	4,767,233	4,347,218	-	420,015		0%
HS - Disaster Relief Grant - 6371	1,662,769	-	-	1,662,769	8%	0%
Loc Early Head Start In-Kind - 4751 Loc	664,789	53,312	-	611,477	0%	102%
Head Start In-Kind Matching - 4791 Loc	3,101,363	1,044,936	-	2,056,427	34%	0%
Head Start In-Kind Matching - 4890	1,168,498	1,329,738	-	(161,240)	114%	0%
Hogg Grant - Mental Health - 4951 Loc	15,990	-	-	15,990		0%
Head Start Hogg Foundation - 4961	7,273	6,701	-	572	92%	0%
Head Start Other Local Grants - 4981	21,189	7,937	3,303	9,949	82%	0%
<b>Total Head Start:</b>	<b>37,250,186</b>	<b>14,466,151</b>	<b>1,508,341</b>	<b>21,275,695</b>	<b>62%</b>	<b>63%</b>
<b>The Teaching and Learning Center</b>						
Texas Council for Developmental Disabilities						0%
NSA Gencyber Grant	-	-	-	-	0%	21%
TCEQ/Audubon	41,216	9,368	21,840	10,008	76%	0%
Local Grants	-	-	-	-	0%	0%
<b>Total The Teaching and Learning Center:</b>	<b>41,216</b>	<b>9,368</b>	<b>21,840</b>	<b>10,008</b>	<b>76%</b>	<b>21%</b>
<b>Total Expenditures &amp; Other Uses:</b>	<b>\$ 51,922,374</b>	<b>\$ 22,495,219</b>	<b>\$ 4,066,787</b>	<b>\$ 25,360,368</b>	<b>67%</b>	<b>52%</b>

**HARRIS COUNTY DEPARTMENT OF EDUCATION**  
INTERIM FINANCIAL REPORTS (Unaudited)  
SPECIAL REVENUE FUNDS 200-499 BUDGET SUMMARY REPORT  
Fiscal year to date: June 30, 2021

Excess/(Deficiency) Estimated Revenues	<u>                    </u>	<u>                    </u>
Over/(Under) Expenditures:	<u>\$ -</u>	<u>\$(3,210,980)</u>

**HARRIS COUNTY DEPARTMENT OF EDUCATION**  
**INTERIM FINANCIAL REPORTS (Unaudited)**  
**DEBT SERVICE FUND 599 BUDGET SUMMARY REPORT**  
 Fiscal year to date: June 30, 2021

	BUDGET	YTD ACTUAL	ENCUM- BRANCES	VARIANCE
<b><u>FUNDING SOURCES</u></b>				
Transfer In from General Fund	\$ 5,717,614	\$ 2,713,556		\$(3,004,058)
Transfer In Debt Service-QZAB	451,429	451,429		-
Issuance of Bonds	-	538,435		538,435
Maint Tax Notes Proceeds	-	198,798		198,798
<b>Total Funding Sources:</b>	<b>6,169,043</b>	<b>3,902,217</b>		<b>(2,266,826)</b>
<b><u>EXPENDITURES</u></b>				
Principal-PFC Bonds	5,555,000	2,305,000	-	3,250,000
Principal-QZAB	451,429	451,429	-	-
Interest-PFC Bonds	162,614	408,556	-	(245,942)
Bond Issuance Fees	-	650,328	-	(650,328)
<b>Total Expenditures:</b>	<b>6,169,043</b>	<b>3,815,312</b>	<b>-</b>	<b>2,353,731</b>
<b>Excess/(Deficiency) Estimated Revenues Over/(Under) Expenditures:</b>	<b>-</b>	<b>86,905</b>		
Beginning Fund Balance-September 1st:	-	-		
<b>Estimated Fund Balance:</b>	<b>\$ -</b>	<b>\$ 86,905</b>		

NOTE: A negative balance in the revenue variance column represents the amount pending to be collected as compared to the budget. A positive balance in the expenditure variance column represents the amount available to spend as compared to the budget.

<b><u>Efficient Leverage Indicator:</u> Debt to Income Ratio</b>			
Annual Principal & Interest Payments on Term Debt & Capital Leases		3,815,312	
General Fund Revenues less Facility Charges	=	49,932,924 - 4,455,990	= 8.39%



**HARRIS COUNTY DEPARTMENT OF EDUCATION**  
**INTERIM FINANCIAL REPORTS (Unaudited)**  
**CAPITAL PROJECT FUND BUDGET SUMMARY REPORT**  
 Fiscal year to date: June 30, 2021

	BUDGET	YTD ACTUAL	ENCUM- BRANCES	VARIANCE
<b><u>REVENUES</u></b>				
Issuance of Bonds	\$ 30,581,882	\$ 30,581,882		\$ -
Investment Earnings	251,888	8,126		(243,762)
Transfers In-General Fund	6,266,705	-		(6,266,705)
FEMA Reimbursement	1,174,572	-		(1,174,572)
Other Local Revenues	-	-		-
Maintenance Tax Notes Proceeds	15,873,000	15,873,000		-
<b>Total Revenues:</b>	<b>54,148,047</b>	<b>46,463,008</b>		<b>(7,685,039)</b>
<b><u>EXPENDITURES</u></b>				
Facilities Construction	54,953,973	2,655,775	15,200,593	37,097,605
Transfers Out to Debt Service Fund	-	-	-	-
<b>Total Expenditures:</b>	<b>54,953,973</b>	<b>2,655,775</b>	<b>15,200,593</b>	<b>37,097,605</b>
<b>Excess/(Deficiency) Estimated Revenues Over/(Under) Expenditures:</b>	<b>(805,926)</b>	<b>43,807,233</b>		
Beginning Fund Balance-September 1st:	2,939,650	2,939,650		
<b>Estimated Fund Balance:</b>	<b>\$ 2,133,724</b>	<b>\$ 46,746,883</b>		

NOTE: A negative balance in the revenue variance column represents the amount pending to be collected as compared to the budget. A positive balance in the expenditure variance column represents the amount available to spend as compared to the budget.

**HARRIS COUNTY DEPARTMENT OF EDUCATION**  
**INTERIM FINANCIAL REPORTS (Unaudited)**  
**CHOICE PARTNERS FUND 711 BUDGET SUMMARY REPORT**  
 Fiscal year to date: June 30, 2021

	BUDGET	YTD ACTUAL	ENCUM- BRANCES	VARIANCE
<b><u>REVENUES</u></b>				
5720-Local Revenue - School Districts	\$ 5,196,380	\$ 5,785,521		\$ 589,141
5740-Local Revenue - Other	32,000	(3)		(32,003)
<b>Total Revenues:</b>	<b>5,228,380</b>	<b>5,785,518</b>		<b>557,138</b>
<b><u>EXPENDITURES</u></b>				
6100-Payroll Costs	1,677,946	1,283,606	-	394,340
6200-Contracted Services	492,190	146,378	96,090	249,722
6300-Supplies and Materials	203,690	71,606	16,511	115,574
6400-Miscellaneous Operating Costs	427,314	131,548	22,886	272,880
8900-Transfers Out	2,927,240	4,152,381	-	(1,225,141)
<b>Total Expenditures:</b>	<b>5,728,380</b>	<b>5,785,518</b>	<b>135,487</b>	<b>(192,625)</b>
<b>Excess/(Deficiency) Estimated Revenues Over/(Under) Expenditures:</b>	<b>(500,000)</b>	<b>-</b>		
Beginning Fund Balance-September 1st:	1,500,000	1,500,000		
<b>Estimated Fund Balance:</b>	<b>\$ 1,000,000</b>	<b>\$ 1,500,000</b>		

NOTE: A negative balance in the revenue variance column represents the amount pending to be collected as compared to the budget. A positive balance in the expenditure variance column represents the amount available to spend as compared to the budget.

**HARRIS COUNTY DEPARTMENT OF EDUCATION**  
**INTERIM FINANCIAL REPORTS (Unaudited)**  
**WORKERS COMPENSATION FUND 753 BUDGET SUMMARY REPORT**  
 Fiscal year to date: June 30, 2021

	BUDGET	YTD ACTUAL	ENCUM- BRANCES	VARIANCE
<b><u>REVENUES</u></b>				
Revenues	\$ 475,000	\$ 293,776		\$(181,224)
Insurance Recovery	-	355		355
<b>Total Revenues:</b>	<b>475,000</b>	<b>294,131</b>		<b>(180,869)</b>
<b><u>EXPENDITURES</u></b>				
6400-Misc Operating Costs	475,000	342,314	-	132,686
<b>Total Expenditures:</b>	<b>475,000</b>	<b>342,314</b>	<b>-</b>	<b>132,686</b>
<b>Excess/(Deficiency) Estimated Revenues Over/(Under) Expenditures:</b>	<b>-</b>	<b>(48,183)</b>		
Beginning Fund Balance-September 1st:	1,358,477	1,358,477		
<b>Estimated Fund Balance:</b>	<b>\$ 1,358,477</b>	<b>\$ 1,310,294</b>		

NOTE: A negative balance in the revenue variance column represents the amount pending to be collected as compared to the budget. A positive balance in the expenditure variance column represents the amount available to spend as compared to the budget.

**HARRIS COUNTY DEPARTMENT OF EDUCATION**  
**INTERIM FINANCIAL REPORTS (Unaudited)**  
**INTERNAL SERVICE FUND 799 BUDGET SUMMARY REPORT**  
 Fiscal year to date: June 30, 2021

	BUDGET	YTD ACTUAL	ENCUM- BRANCES	VARIANCE
<b><u>REVENUES</u></b>				
Interdepartmental Revenues	\$ 5,806,832	\$ 4,455,990		\$(1,350,842)
<b>Total Revenues:</b>	<b>5,806,832</b>	<b>4,455,990</b>		<b>(1,350,842)</b>
<b><u>EXPENDITURES</u></b>				
6100-Payroll Costs	2,816,390	2,281,260	-	535,130
6200-Contracted Services	2,029,441	1,309,025	267,812	452,604
6300-Supplies and Materials	281,585	220,811	9,618	51,156
6400-Miscellaneous Operating Costs	679,416	644,895	8,544	25,977
<b>Total Expenditures:</b>	<b>5,806,832</b>	<b>4,455,990</b>	<b>285,974</b>	<b>1,064,868</b>
<b>Excess/(Deficiency) Estimated Revenues Over/(Under) Expenditures:</b>	-	-		
Beginning Fund Balance-September 1st:	-	-		
<b>Estimated Fund Balance:</b>	<b>\$ -</b>	<b>\$ -</b>		

NOTE: A negative balance in the revenue variance column represents the amount pending to be collected as compared to the budget. A positive balance in the expenditure variance column represents the amount available to spend as compared to the budget.

**HARRIS COUNTY DEPARTMENT OF EDUCATION**  
**INTERIM FINANCIAL REPORTS (Unaudited)**  
**TRUST & AGENCY FUNDS 800-840 BUDGET SUMMARY REPORT**  
 Fiscal year to date: June 30, 2021

Schedule 10

	TOTAL
Revenues	\$ 6,983
Expenditures	1,550
<b>Revenues Over/(Under) Expenditures:</b>	<b>\$ 5,433</b>
Beginning Fund Balance-September 1st:	-
<b>Estimated Fund Balance:</b>	<b>\$ 5,433</b>

NOTE: Revenues and Expenditures are reclassified to the balance sheet at year end.

**HARRIS COUNTY DEPARTMENT OF EDUCATION**  
**INTERIM FINANCIAL REPORTS (Unaudited)**  
**LOCAL CONSTRUCTION PROJECTS-BM '087' BUDGET SUMMARY REPORT**  
 Fiscal year to date: June 30, 2021

	BUDGET	YTD ACTUAL	ENCUM- BRANCES	VARIANCE
<b><u>EXPENDITURES</u></b>				
ABS West	\$ 93,648	\$ 35,486	\$ -	\$ 58,162
Fortis Academy	276,264	276,264	-	-
Facilities - Central Support	3,750	-	-	3,750
Facilities - Post Oak	258,264	249,764	8,500	1
<b>Total Expenditures:</b>	<b>631,926</b>	<b>561,513</b>	<b>8,500</b>	<b>61,913</b>

NOTE: These projects are funded from the General Fund-Assigned Fund Balance.

**HARRIS COUNTY DEPARTMENT OF EDUCATION**  
**INTERIM FINANCIAL REPORTS (Unaudited)**  
**GENERAL FUNDS DETAIL BY DIVISION**  
**ACTUALS AND ENCUMBRANCES-CURRENT YEAR V. PRIOR YEAR**  
Fiscal year to date: June 30, 2021

<b>Adult Education-Local</b>			
	CURRENT YEAR- BUDGET	CURRENT YEAR- ACTUAL REV, EXP AND ENC	PRIOR YEAR- ACTUAL REV, EXP & ENC
<b><u>REVENUES &amp; OTHER RESOURCES</u></b>			
<b>Revenues</b>			
Customer Fees/Charges	\$ -	\$ -	\$ -
Local Property Tax Rev-Current	-	-	-
Local Property Tax Rev-Del, P&I	-	-	-
Investment Earnings	-	-	-
Insurance Recovery	-	-	-
FSP-Compensation	-	-	-
TEA-State Health Ins-Employee Portion	-	-	-
Local Grants	-	-	-
Other Local Revenues	-	500	-
Miscellaneous Revenues	-	-	-
Indirect Cost Rev-Local Grants	-	-	-
Indirect Cost Rev-State	-	-	-
Indirect Cost Rev-Federal Grants	176,707	133,446	126,552
<b>Total Revenues:</b>	<u>\$ 176,707</u>	<u>\$ 133,946</u>	<u>\$ 126,552</u>
<b>Other Resources</b>			
Local HCTO Tax Collection Fees	-	-	-
State TRS Matching	-	-	-
Transfers In-Choice Partners	-	-	-
<b>Total Other Resources:</b>	<u>\$ -</u>	<u>\$ -</u>	<u>\$ -</u>
<b>Total Revenues &amp; Other Resources:</b>	<u>\$ 176,707</u>	<u>\$ 133,946</u>	<u>\$ 126,552</u>
<b><u>EXPENDITURES &amp; OTHER USES</u></b>			
<b>Expenditures &amp; Encumbrances</b>			
Payroll Costs	-	-	-
Contracted & Professional Services	5,916	8,560	4,844
Supplies & Materials	5,450	2,632	1,354
Other Operating Costs	165,341	122,254	120,791
Debt Services	-	-	-
Capital Outlay	-	-	-
<b>Total Expenditures &amp; Encumbrances:</b>	<u>\$ 176,707</u>	<u>\$ 133,446</u>	<u>\$ 126,989</u>
<b>Other Uses</b>			
Transfers Out-Special Revenue Funds	-	-	-
Transfers Out-Head Start Fund 205	-	-	-
Transfers Out-Head Start Fund 289	-	-	-
Transfers Out-Debt Service	-	-	-
Transfers Out-PFC Fund	-	-	-
Transfers Out-Department Wide	-	-	-
Transfers Out-COVID-19	-	-	-
Transfers Out-Star Reimagined	-	-	-
<b>Total Other Uses:</b>	<u>\$ -</u>	<u>\$ -</u>	<u>\$ -</u>
<b>Total Expenditures &amp; Other Uses:</b>	<u>\$ 176,707</u>	<u>\$ 133,446</u>	<u>\$ 126,989</u>
<b>Revenue Over/(Under) Expenditures:</b>	<u>\$ -</u>	<u>\$ 500</u>	<u>\$(436)</u>

**HARRIS COUNTY DEPARTMENT OF EDUCATION**  
**INTERIM FINANCIAL REPORTS (Unaudited)**  
**GENERAL FUNDS DETAIL BY DIVISION**  
**ACTUALS AND ENCUMBRANCES-CURRENT YEAR V. PRIOR YEAR**  
Fiscal year to date: June 30, 2021

Schedule 12

**Educator Certification & Advancement**

	CURRENT YEAR- BUDGET	CURRENT YEAR- ACTUAL REV, EXP AND ENC	PRIOR YEAR- ACTUAL REV, EXP & ENC
<b><u>REVENUES &amp; OTHER RESOURCES</u></b>			
<b>Revenues</b>			
Customer Fees/Charges	\$ 307,045	\$ 220,275	\$ 101,187
Local Property Tax Rev-Current	407,226	331,202	415,161
Local Property Tax Rev-Del, P&I	-	-	-
Investment Earnings	-	-	-
Insurance Recovery	-	-	-
FSP-Compensation	-	-	-
TEA-State Health Ins-Employee Portion	-	-	-
Local Grants	-	-	-
Other Local Revenues	-	-	-
Miscellaneous Revenues	-	-	-
Indirect Cost Rev-Local Grants	-	-	-
Indirect Cost Rev-State	-	-	-
Indirect Cost Rev-Federal Grants	-	-	-
<b>Total Revenues:</b>	<u>\$ 714,271</u>	<u>\$ 551,477</u>	<u>\$ 516,348</u>
<b>Other Resources</b>			
Local HCTO Tax Collection Fees	-	-	-
State TRS Matching	-	-	-
Transfers In-Choice Partners	-	-	-
<b>Total Other Resources:</b>	<u>\$ -</u>	<u>\$ -</u>	<u>\$ -</u>
<b>Total Revenues &amp; Other Resources:</b>	<u>\$ 714,271</u>	<u>\$ 551,477</u>	<u>\$ 516,348</u>
<b><u>EXPENDITURES &amp; OTHER USES</u></b>			
<b>Expenditures &amp; Encumbrances</b>			
Payroll Costs	582,067	458,123	454,223
Contracted & Professional Services	73,950	64,471	26,321
Supplies & Materials	40,978	31,557	10,916
Other Operating Costs	17,276	10,772	28,563
Debt Services	-	-	-
Capital Outlay	-	-	-
<b>Total Expenditures &amp; Encumbrances:</b>	<u>\$ 714,271</u>	<u>\$ 564,923</u>	<u>\$ 520,023</u>
<b>Other Uses</b>			
Transfers Out-Special Revenue Funds	-	-	-
Transfers Out-Head Start Fund 205	-	-	-
Transfers Out-Head Start Fund 289	-	-	-
Transfers Out-Debt Service	-	-	-
Transfers Out-PFC Fund	-	-	-
Transfers Out-Department Wide	-	-	-
Transfers Out-COVID-19	-	-	-
Transfers Out-Star Reimagined	-	-	-
<b>Total Other Uses:</b>	<u>\$ -</u>	<u>\$ -</u>	<u>\$ -</u>
<b>Total Expenditures &amp; Other Uses:</b>	<u>\$ 714,271</u>	<u>\$ 564,923</u>	<u>\$ 520,023</u>
<b>Revenue Over/(Under) Expenditures:</b>	<u>\$ -</u>	<u>\$(13,446)</u>	<u>\$(3,675)</u>



**HARRIS COUNTY DEPARTMENT OF EDUCATION**  
**INTERIM FINANCIAL REPORTS (Unaudited)**  
**GENERAL FUNDS DETAIL BY DIVISION**  
**ACTUALS AND ENCUMBRANCES-CURRENT YEAR V. PRIOR YEAR**  
Fiscal year to date: June 30, 2021

Schedule 12

**Assistant Superintendent-Academic Support**

	CURRENT YEAR- BUDGET	CURRENT YEAR- ACTUAL REV, EXP AND ENC	PRIOR YEAR- ACTUAL REV, EXP & ENC
<b><u>REVENUES &amp; OTHER RESOURCES</u></b>			
<b>Revenues</b>			
Customer Fees/Charges	\$ -	\$ -	\$ -
Local Property Tax Rev-Current	327,872	249,065	250,428
Local Property Tax Rev-Del, P&I	-	-	-
Investment Earnings	-	-	-
Insurance Recovery	-	-	-
FSP-Compensation	-	-	-
TEA-State Health Ins-Employee Portion	-	-	-
Local Grants	-	-	-
Other Local Revenues	-	-	-
Miscellaneous Revenues	-	-	-
Indirect Cost Rev-Local Grants	-	-	-
Indirect Cost Rev-State	-	-	-
Indirect Cost Rev-Federal Grants	-	-	-
<b>Total Revenues:</b>	<u>\$ 327,872</u>	<u>\$ 249,065</u>	<u>\$ 250,428</u>
<b>Other Resources</b>			
Local HCTO Tax Collection Fees	-	-	-
State TRS Matching	-	-	-
Transfers In-Choice Partners	-	-	-
<b>Total Other Resources:</b>	<u>\$ -</u>	<u>\$ -</u>	<u>\$ -</u>
<b>Total Revenues &amp; Other Resources:</b>	<u>\$ 327,872</u>	<u>\$ 249,065</u>	<u>\$ 250,428</u>
<b><u>EXPENDITURES &amp; OTHER USES</u></b>			
<b>Expenditures &amp; Encumbrances</b>			
Payroll Costs	287,565	237,229	230,768
Contracted & Professional Services	1,310	936	1,586
Supplies & Materials	5,842	3,423	1,566
Other Operating Costs	33,155	7,477	16,509
Debt Services	-	-	-
Capital Outlay	-	-	-
<b>Total Expenditures &amp; Encumbrances:</b>	<u>\$ 327,872</u>	<u>\$ 249,065</u>	<u>\$ 250,428</u>
<b>Other Uses</b>			
Transfers Out-Special Revenue Funds	-	-	-
Transfers Out-Head Start Fund 205	-	-	-
Transfers Out-Head Start Fund 289	-	-	-
Transfers Out-Debt Service	-	-	-
Transfers Out-PFC Fund	-	-	-
Transfers Out-Department Wide	-	-	-
Transfers Out-COVID-19	-	-	-
Transfers Out-Star Reimagined	-	-	-
<b>Total Other Uses:</b>	<u>\$ -</u>	<u>\$ -</u>	<u>\$ -</u>
<b>Total Expenditures &amp; Other Uses:</b>	<u>\$ 327,872</u>	<u>\$ 249,065</u>	<u>\$ 250,428</u>
<b>Revenue Over/(Under) Expenditures:</b>	<u>\$ -</u>	<u>\$ -</u>	<u>\$ -</u>

**HARRIS COUNTY DEPARTMENT OF EDUCATION**  
**INTERIM FINANCIAL REPORTS (Unaudited)**  
**GENERAL FUNDS DETAIL BY DIVISION**  
**ACTUALS AND ENCUMBRANCES-CURRENT YEAR V. PRIOR YEAR**  
Fiscal year to date: June 30, 2021

**Asst Supt-Education and Enrichment**

	CURRENT YEAR- BUDGET	CURRENT YEAR- ACTUAL REV, EXP AND ENC	PRIOR YEAR- ACTUAL REV, EXP & ENC
<b><u>REVENUES &amp; OTHER RESOURCES</u></b>			
<b>Revenues</b>			
Customer Fees/Charges	\$ -	\$ -	\$ -
Local Property Tax Rev-Current	300,324	237,602	201,734
Local Property Tax Rev-Del, P&I	-	-	-
Investment Earnings	-	-	-
Insurance Recovery	-	-	-
FSP-Compensation	-	-	-
TEA-State Health Ins-Employee Portion	-	-	-
Local Grants	-	-	-
Other Local Revenues	-	-	-
Miscellaneous Revenues	-	-	-
Indirect Cost Rev-Local Grants	-	-	-
Indirect Cost Rev-State	-	-	-
Indirect Cost Rev-Federal Grants	-	-	-
<b>Total Revenues:</b>	<u>\$ 300,324</u>	<u>\$ 237,602</u>	<u>\$ 201,734</u>
<b>Other Resources</b>			
Local HCTO Tax Collection Fees	-	-	-
State TRS Matching	-	-	-
Transfers In-Choice Partners	-	-	-
<b>Total Other Resources:</b>	<u>\$ -</u>	<u>\$ -</u>	<u>\$ -</u>
<b>Total Revenues &amp; Other Resources:</b>	<u>\$ 300,324</u>	<u>\$ 237,602</u>	<u>\$ 201,734</u>
<b><u>EXPENDITURES &amp; OTHER USES</u></b>			
<b>Expenditures &amp; Encumbrances</b>			
Payroll Costs	265,970	223,298	176,902
Contracted & Professional Services	2,020	1,378	495
Supplies & Materials	9,350	6,043	6,470
Other Operating Costs	22,984	8,586	17,867
Debt Services	-	-	-
Capital Outlay	-	-	-
<b>Total Expenditures &amp; Encumbrances:</b>	<u>\$ 300,324</u>	<u>\$ 239,305</u>	<u>\$ 201,734</u>
<b>Other Uses</b>			
Transfers Out-Special Revenue Funds	-	-	-
Transfers Out-Head Start Fund 205	-	-	-
Transfers Out-Head Start Fund 289	-	-	-
Transfers Out-Debt Service	-	-	-
Transfers Out-PFC Fund	-	-	-
Transfers Out-Department Wide	-	-	-
Transfers Out-COVID-19	-	-	-
Transfers Out-Star Reimagined	-	-	-
<b>Total Other Uses:</b>	<u>\$ -</u>	<u>\$ -</u>	<u>\$ -</u>
<b>Total Expenditures &amp; Other Uses:</b>	<u>\$ 300,324</u>	<u>\$ 239,305</u>	<u>\$ 201,734</u>
<b>Revenue Over/(Under) Expenditures:</b>	<u>\$ -</u>	<u>\$(1,703)</u>	<u>\$ -</u>

**HARRIS COUNTY DEPARTMENT OF EDUCATION**  
**INTERIM FINANCIAL REPORTS (Unaudited)**  
**GENERAL FUNDS DETAIL BY DIVISION**  
**ACTUALS AND ENCUMBRANCES-CURRENT YEAR V. PRIOR YEAR**  
Fiscal year to date: June 30, 2021

Schedule 12

<b>Board of Trustees</b>			
	CURRENT YEAR- BUDGET	CURRENT YEAR- ACTUAL REV, EXP AND ENC	PRIOR YEAR- ACTUAL REV, EXP & ENC
<b><u>REVENUES &amp; OTHER RESOURCES</u></b>			
<b>Revenues</b>			
Customer Fees/Charges	\$ -	\$ -	\$ -
Local Property Tax Rev-Current	198,143	116,574	116,620
Local Property Tax Rev-Del, P&I	-	-	-
Investment Earnings	-	-	-
Insurance Recovery	-	-	-
FSP-Compensation	-	-	-
TEA-State Health Ins-Employee Portion	-	-	-
Local Grants	-	-	-
Other Local Revenues	-	-	-
Miscellaneous Revenues	-	-	-
Indirect Cost Rev-Local Grants	-	-	-
Indirect Cost Rev-State	-	-	-
Indirect Cost Rev-Federal Grants	-	-	-
<b>Total Revenues:</b>	<u>\$ 198,143</u>	<u>\$ 116,574</u>	<u>\$ 116,620</u>
<b>Other Resources</b>			
Local HCTO Tax Collection Fees	-	-	-
State TRS Matching	-	-	-
Transfers In-Choice Partners	-	-	-
<b>Total Other Resources:</b>	<u>\$ -</u>	<u>\$ -</u>	<u>\$ -</u>
<b>Total Revenues &amp; Other Resources:</b>	<u>\$ 198,143</u>	<u>\$ 116,574</u>	<u>\$ 116,620</u>
<b><u>EXPENDITURES &amp; OTHER USES</u></b>			
<b>Expenditures &amp; Encumbrances</b>			
Payroll Costs	57,525	36,363	46,487
Contracted & Professional Services	31,000	43,747	33,549
Supplies & Materials	26,750	5,158	9,756
Other Operating Costs	82,868	31,306	29,399
Debt Services	-	-	-
Capital Outlay	-	-	-
<b>Total Expenditures &amp; Encumbrances:</b>	<u>\$ 198,143</u>	<u>\$ 116,574</u>	<u>\$ 119,191</u>
<b>Other Uses</b>			
Transfers Out-Special Revenue Funds	-	-	-
Transfers Out-Head Start Fund 205	-	-	-
Transfers Out-Head Start Fund 289	-	-	-
Transfers Out-Debt Service	-	-	-
Transfers Out-PFC Fund	-	-	-
Transfers Out-Department Wide	-	-	-
Transfers Out-COVID-19	-	-	-
Transfers Out-Star Reimagined	-	-	-
<b>Total Other Uses:</b>	<u>\$ -</u>	<u>\$ -</u>	<u>\$ -</u>
<b>Total Expenditures &amp; Other Uses:</b>	<u>\$ 198,143</u>	<u>\$ 116,574</u>	<u>\$ 119,191</u>
<b>Revenue Over/(Under) Expenditures:</b>	<u>\$ -</u>	<u>\$ -</u>	<u>\$(2,571)</u>

**HARRIS COUNTY DEPARTMENT OF EDUCATION**  
**INTERIM FINANCIAL REPORTS (Unaudited)**  
**GENERAL FUNDS DETAIL BY DIVISION**  
**ACTUALS AND ENCUMBRANCES-CURRENT YEAR V. PRIOR YEAR**  
Fiscal year to date: June 30, 2021

**COVID-19 Disaster Recovery**

	CURRENT YEAR- BUDGET	CURRENT YEAR- ACTUAL REV, EXP AND ENC	PRIOR YEAR- ACTUAL REV, EXP & ENC
<b><u>REVENUES &amp; OTHER RESOURCES</u></b>			
<b>Revenues</b>			
Customer Fees/Charges	\$ -	\$ -	\$ -
Local Property Tax Rev-Current	-	-	-
Local Property Tax Rev-Del, P&I	-	-	-
Investment Earnings	-	-	-
Insurance Recovery	-	-	-
FSP-Compensation	-	-	-
TEA-State Health Ins-Employee Portion	-	-	-
Local Grants	-	-	-
Other Local Revenues	-	-	-
Miscellaneous Revenues	-	-	-
Indirect Cost Rev-Local Grants	-	-	-
Indirect Cost Rev-State	-	-	-
Indirect Cost Rev-Federal Grants	-	-	-
<b>Total Revenues:</b>	\$ -	\$ -	\$ -
<b>Other Resources</b>			
Local HCTO Tax Collection Fees	-	-	-
State TRS Matching	-	-	-
Transfers In-Choice Partners	-	-	-
<b>Total Other Resources:</b>	\$ -	\$ -	\$ -
<b>Total Revenues &amp; Other Resources:</b>	\$ -	\$ -	\$ -
<b><u>EXPENDITURES &amp; OTHER USES</u></b>			
<b>Expenditures &amp; Encumbrances</b>			
Payroll Costs	-	-	-
Contracted & Professional Services	-	-	-
Supplies & Materials	-	-	11,756
Other Operating Costs	-	-	-
Debt Services	-	-	-
Capital Outlay	-	-	-
<b>Total Expenditures &amp; Encumbrances:</b>	\$ -	\$ -	\$ 11,756
<b>Other Uses</b>			
Transfers Out-Special Revenue Funds	-	-	-
Transfers Out-Head Start Fund 205	-	-	-
Transfers Out-Head Start Fund 289	-	-	-
Transfers Out-Debt Service	-	-	-
Transfers Out-PFC Fund	-	-	-
Transfers Out-Department Wide	-	-	-
Transfers Out-COVID-19	-	-	-
Transfers Out-Star Reimagined	-	-	-
<b>Total Other Uses:</b>	\$ -	\$ -	\$ -
<b>Total Expenditures &amp; Other Uses:</b>	\$ -	\$ -	\$ 11,756
<b>Revenue Over/(Under) Expenditures:</b>	\$ -	\$ -	\$(11,756)

**HARRIS COUNTY DEPARTMENT OF EDUCATION**  
**INTERIM FINANCIAL REPORTS (Unaudited)**  
**GENERAL FUNDS DETAIL BY DIVISION**  
**ACTUALS AND ENCUMBRANCES-CURRENT YEAR V. PRIOR YEAR**  
Fiscal year to date: June 30, 2021

Schedule 12

**Business Support Services**

	CURRENT YEAR- BUDGET	CURRENT YEAR- ACTUAL REV, EXP AND ENC	PRIOR YEAR- ACTUAL REV, EXP & ENC
<b><u>REVENUES &amp; OTHER RESOURCES</u></b>			
<b>Revenues</b>			
Customer Fees/Charges	\$ 80,000	\$ 100,383	\$ 133,373
Local Property Tax Rev-Current	1,313,244	1,123,603	1,106,945
Local Property Tax Rev-Del, P&I	-	-	-
Investment Earnings	-	-	-
Insurance Recovery	-	-	-
FSP-Compensation	-	-	-
TEA-State Health Ins-Employee Portion	-	-	-
Local Grants	-	-	-
Other Local Revenues	-	-	-
Miscellaneous Revenues	-	-	-
Indirect Cost Rev-Local Grants	-	-	-
Indirect Cost Rev-State	-	-	-
Indirect Cost Rev-Federal Grants	695,385	425,252	399,140
<b>Total Revenues:</b>	<b>\$ 2,088,629</b>	<b>\$ 1,649,238</b>	<b>\$ 1,639,458</b>
<b>Other Resources</b>			
Local HCTO Tax Collection Fees	-	-	-
State TRS Matching	-	-	-
Transfers In-Choice Partners	-	-	-
<b>Total Other Resources:</b>	<b>\$ -</b>	<b>\$ -</b>	<b>\$ -</b>
<b>Total Revenues &amp; Other Resources:</b>	<b>\$ 2,088,629</b>	<b>\$ 1,649,238</b>	<b>\$ 1,639,458</b>
<b><u>EXPENDITURES &amp; OTHER USES</u></b>			
<b>Expenditures &amp; Encumbrances</b>			
Payroll Costs	1,427,393	1,148,137	1,135,628
Contracted & Professional Services	540,727	467,309	491,345
Supplies & Materials	62,442	39,009	61,711
Other Operating Costs	98,067	69,842	66,325
Debt Services	-	-	-
Capital Outlay	-	-	-
<b>Total Expenditures &amp; Encumbrances:</b>	<b>\$ 2,128,629</b>	<b>\$ 1,724,297</b>	<b>\$ 1,755,009</b>
<b>Other Uses</b>			
Transfers Out-Special Revenue Funds	-	-	-
Transfers Out-Head Start Fund 205	-	-	-
Transfers Out-Head Start Fund 289	-	-	-
Transfers Out-Debt Service	-	-	-
Transfers Out-PFC Fund	-	-	-
Transfers Out-Department Wide	-	-	-
Transfers Out-COVID-19	-	-	-
Transfers Out-Star Reimagined	-	-	-
<b>Total Other Uses:</b>	<b>\$ -</b>	<b>\$ -</b>	<b>\$ -</b>
<b>Total Expenditures &amp; Other Uses:</b>	<b>\$ 2,128,629</b>	<b>\$ 1,724,297</b>	<b>\$ 1,755,009</b>
<b>Revenue Over/(Under) Expenditures:</b>	<b>\$(40,000)</b>	<b>\$(75,059)</b>	<b>\$(115,551)</b>

**HARRIS COUNTY DEPARTMENT OF EDUCATION**  
**INTERIM FINANCIAL REPORTS (Unaudited)**  
**GENERAL FUNDS DETAIL BY DIVISION**  
**ACTUALS AND ENCUMBRANCES-CURRENT YEAR V. PRIOR YEAR**  
Fiscal year to date: June 30, 2021

Schedule 12

**Center for Safe & Secure Schools**

	CURRENT YEAR- BUDGET	CURRENT YEAR- ACTUAL REV, EXP AND ENC	PRIOR YEAR- ACTUAL REV, EXP & ENC
<b><u>REVENUES &amp; OTHER RESOURCES</u></b>			
<b>Revenues</b>			
Customer Fees/Charges	\$ 223,200	\$ 208,757	\$ 270,087
Local Property Tax Rev-Current	431,103	163,682	202,759
Local Property Tax Rev-Del, P&I	-	-	-
Investment Earnings	-	-	-
Insurance Recovery	-	-	-
FSP-Compensation	-	-	-
TEA-State Health Ins-Employee Portion	-	-	-
Local Grants	-	-	-
Other Local Revenues	-	-	(170)
Miscellaneous Revenues	-	-	-
Indirect Cost Rev-Local Grants	-	-	-
Indirect Cost Rev-State	-	-	-
Indirect Cost Rev-Federal Grants	-	-	-
<b>Total Revenues:</b>	<b>\$ 654,303</b>	<b>\$ 372,439</b>	<b>\$ 472,676</b>
<b>Other Resources</b>			
Local HCTO Tax Collection Fees	-	-	-
State TRS Matching	-	-	-
Transfers In-Choice Partners	-	-	-
<b>Total Other Resources:</b>	<b>\$ -</b>	<b>\$ -</b>	<b>\$ -</b>
<b>Total Revenues &amp; Other Resources:</b>	<b>\$ 654,303</b>	<b>\$ 372,439</b>	<b>\$ 472,676</b>
<b><u>EXPENDITURES &amp; OTHER USES</u></b>			
<b>Expenditures &amp; Encumbrances</b>			
Payroll Costs	416,470	299,363	323,222
Contracted & Professional Services	136,432	50,344	224,907
Supplies & Materials	36,100	12,114	17,117
Other Operating Costs	65,301	28,136	40,687
Debt Services	-	-	-
Capital Outlay	-	-	-
<b>Total Expenditures &amp; Encumbrances:</b>	<b>\$ 654,303</b>	<b>\$ 389,956</b>	<b>\$ 605,932</b>
<b>Other Uses</b>			
Transfers Out-Special Revenue Funds	-	-	-
Transfers Out-Head Start Fund 205	-	-	-
Transfers Out-Head Start Fund 289	-	-	-
Transfers Out-Debt Service	-	-	-
Transfers Out-PFC Fund	-	-	-
Transfers Out-Department Wide	-	-	-
Transfers Out-COVID-19	-	-	-
Transfers Out-Star Reimagined	-	-	-
<b>Total Other Uses:</b>	<b>\$ -</b>	<b>\$ -</b>	<b>\$ -</b>
<b>Total Expenditures &amp; Other Uses:</b>	<b>\$ 654,303</b>	<b>\$ 389,956</b>	<b>\$ 605,932</b>
<b>Revenue Over/(Under) Expenditures:</b>	<b>\$ -</b>	<b>\$(17,517)</b>	<b>\$(133,256)</b>

**HARRIS COUNTY DEPARTMENT OF EDUCATION**  
**INTERIM FINANCIAL REPORTS (Unaudited)**  
**GENERAL FUNDS DETAIL BY DIVISION**  
**ACTUALS AND ENCUMBRANCES-CURRENT YEAR V. PRIOR YEAR**  
 Fiscal year to date: June 30, 2021

Schedule 12

<b>Communication</b>			
	CURRENT YEAR- BUDGET	CURRENT YEAR- ACTUAL REV, EXP AND ENC	PRIOR YEAR- ACTUAL REV, EXP & ENC
<b><u>REVENUES &amp; OTHER RESOURCES</u></b>			
<b>Revenues</b>			
Customer Fees/Charges	\$ -	\$ -	\$ -
Local Property Tax Rev-Current	1,193,018	709,570	687,075
Local Property Tax Rev-Del, P&I	-	-	-
Investment Earnings	-	-	-
Insurance Recovery	-	-	-
FSP-Compensation	-	-	-
TEA-State Health Ins-Employee Portion	-	-	-
Local Grants	-	-	-
Other Local Revenues	-	-	-
Miscellaneous Revenues	-	-	-
Indirect Cost Rev-Local Grants	-	-	-
Indirect Cost Rev-State	-	-	-
Indirect Cost Rev-Federal Grants	-	-	-
<b>Total Revenues:</b>	<u>\$ 1,193,018</u>	<u>\$ 709,570</u>	<u>\$ 687,075</u>
<b>Other Resources</b>			
Local HCTO Tax Collection Fees	-	-	-
State TRS Matching	-	-	-
Transfers In-Choice Partners	-	-	-
<b>Total Other Resources:</b>	<u>\$ -</u>	<u>\$ -</u>	<u>\$ -</u>
<b>Total Revenues &amp; Other Resources:</b>	<u>\$ 1,193,018</u>	<u>\$ 709,570</u>	<u>\$ 687,075</u>
<b><u>EXPENDITURES &amp; OTHER USES</u></b>			
<b>Expenditures &amp; Encumbrances</b>			
Payroll Costs	995,698	628,311	595,495
Contracted & Professional Services	61,490	38,803	38,410
Supplies & Materials	73,753	23,228	40,471
Other Operating Costs	62,077	25,211	34,935
Debt Services	-	-	-
Capital Outlay	-	-	-
<b>Total Expenditures &amp; Encumbrances:</b>	<u>\$ 1,193,018</u>	<u>\$ 715,553</u>	<u>\$ 709,311</u>
<b>Other Uses</b>			
Transfers Out-Special Revenue Funds	-	-	-
Transfers Out-Head Start Fund 205	-	-	-
Transfers Out-Head Start Fund 289	-	-	-
Transfers Out-Debt Service	-	-	-
Transfers Out-PFC Fund	-	-	-
Transfers Out-Department Wide	-	-	-
Transfers Out-COVID-19	-	-	-
Transfers Out-Star Reimagined	-	-	-
<b>Total Other Uses:</b>	<u>\$ -</u>	<u>\$ -</u>	<u>\$ -</u>
<b>Total Expenditures &amp; Other Uses:</b>	<u>\$ 1,193,018</u>	<u>\$ 715,553</u>	<u>\$ 709,311</u>
<b>Revenue Over/(Under) Expenditures:</b>	<u>\$ -</u>	<u>\$(5,984)</u>	<u>\$(22,236)</u>

**HARRIS COUNTY DEPARTMENT OF EDUCATION**  
**INTERIM FINANCIAL REPORTS (Unaudited)**  
**GENERAL FUNDS DETAIL BY DIVISION**  
**ACTUALS AND ENCUMBRANCES-CURRENT YEAR V. PRIOR YEAR**  
Fiscal year to date: June 30, 2021

Schedule 12

<b>Client Engagement</b>			
	CURRENT YEAR- BUDGET	CURRENT YEAR- ACTUAL REV, EXP AND ENC	PRIOR YEAR- ACTUAL REV, EXP & ENC
<b><u>REVENUES &amp; OTHER RESOURCES</u></b>			
<b>Revenues</b>			
Customer Fees/Charges	\$ -	\$ -	\$ -
Local Property Tax Rev-Current	541,869	362,963	355,444
Local Property Tax Rev-Del, P&I	-	-	-
Investment Earnings	-	-	-
Insurance Recovery	-	-	-
FSP-Compensation	-	-	-
TEA-State Health Ins-Employee Portion	-	-	-
Local Grants	-	-	-
Other Local Revenues	-	-	-
Miscellaneous Revenues	-	-	-
Indirect Cost Rev-Local Grants	-	-	-
Indirect Cost Rev-State	-	-	-
Indirect Cost Rev-Federal Grants	-	-	-
<b>Total Revenues:</b>	<u>\$ 541,869</u>	<u>\$ 362,963</u>	<u>\$ 355,444</u>
<b>Other Resources</b>			
Local HCTO Tax Collection Fees	-	-	-
State TRS Matching	-	-	-
Transfers In-Choice Partners	-	-	-
<b>Total Other Resources:</b>	<u>\$ -</u>	<u>\$ -</u>	<u>\$ -</u>
<b>Total Revenues &amp; Other Resources:</b>	<u>\$ 541,869</u>	<u>\$ 362,963</u>	<u>\$ 355,444</u>
<b><u>EXPENDITURES &amp; OTHER USES</u></b>			
<b>Expenditures &amp; Encumbrances</b>			
Payroll Costs	408,272	278,316	281,530
Contracted & Professional Services	14,559	6,058	8,501
Supplies & Materials	30,610	16,148	8,896
Other Operating Costs	88,428	65,722	60,660
Debt Services	-	-	-
Capital Outlay	-	-	-
<b>Total Expenditures &amp; Encumbrances:</b>	<u>\$ 541,869</u>	<u>\$ 366,244</u>	<u>\$ 359,587</u>
<b>Other Uses</b>			
Transfers Out-Special Revenue Funds	-	-	-
Transfers Out-Head Start Fund 205	-	-	-
Transfers Out-Head Start Fund 289	-	-	-
Transfers Out-Debt Service	-	-	-
Transfers Out-PFC Fund	-	-	-
Transfers Out-Department Wide	-	-	-
Transfers Out-COVID-19	-	-	-
Transfers Out-Star Reimagined	-	-	-
<b>Total Other Uses:</b>	<u>\$ -</u>	<u>\$ -</u>	<u>\$ -</u>
<b>Total Expenditures &amp; Other Uses:</b>	<u>\$ 541,869</u>	<u>\$ 366,244</u>	<u>\$ 359,587</u>
<b>Revenue Over/(Under) Expenditures:</b>	<u>\$ -</u>	<u>\$(3,281)</u>	<u>\$(4,143)</u>



**HARRIS COUNTY DEPARTMENT OF EDUCATION**  
**INTERIM FINANCIAL REPORTS (Unaudited)**  
**GENERAL FUNDS DETAIL BY DIVISION**  
**ACTUALS AND ENCUMBRANCES-CURRENT YEAR V. PRIOR YEAR**  
 Fiscal year to date: June 30, 2021

Schedule 12

**Ctr A/S Summ & Exp Learn**

	CURRENT YEAR- BUDGET	CURRENT YEAR- ACTUAL REV, EXP AND ENC	PRIOR YEAR- ACTUAL REV, EXP & ENC
<b><u>REVENUES &amp; OTHER RESOURCES</u></b>			
<b>Revenues</b>			
Customer Fees/Charges	\$ 80,000	\$ 59,880	\$ 71,599
Local Property Tax Rev-Current	690,280	362,015	414,725
Local Property Tax Rev-Del, P&I	-	-	-
Investment Earnings	-	-	-
Insurance Recovery	-	-	-
FSP-Compensation	-	-	-
TEA-State Health Ins-Employee Portion	-	-	-
Local Grants	-	-	-
Other Local Revenues	-	-	-
Miscellaneous Revenues	-	-	-
Indirect Cost Rev-Local Grants	-	-	-
Indirect Cost Rev-State	-	-	-
Indirect Cost Rev-Federal Grants	-	-	-
<b>Total Revenues:</b>	<u>\$ 770,280</u>	<u>\$ 421,895</u>	<u>\$ 486,324</u>
<b>Other Resources</b>			
Local HCTO Tax Collection Fees	-	-	-
State TRS Matching	-	-	-
Transfers In-Choice Partners	-	-	-
<b>Total Other Resources:</b>	<u>\$ -</u>	<u>\$ -</u>	<u>\$ -</u>
<b>Total Revenues &amp; Other Resources:</b>	<u>\$ 770,280</u>	<u>\$ 421,895</u>	<u>\$ 486,324</u>
<b><u>EXPENDITURES &amp; OTHER USES</u></b>			
<b>Expenditures &amp; Encumbrances</b>			
Payroll Costs	261,890	210,017	240,949
Contracted & Professional Services	301,570	257,440	236,158
Supplies & Materials	59,201	23,369	17,386
Other Operating Costs	147,619	50,776	75,512
Debt Services	-	-	-
Capital Outlay	-	-	-
<b>Total Expenditures &amp; Encumbrances:</b>	<u>\$ 770,280</u>	<u>\$ 541,602</u>	<u>\$ 570,006</u>
<b>Other Uses</b>			
Transfers Out-Special Revenue Funds	-	-	-
Transfers Out-Head Start Fund 205	-	-	-
Transfers Out-Head Start Fund 289	-	-	-
Transfers Out-Debt Service	-	-	-
Transfers Out-PFC Fund	-	-	-
Transfers Out-Department Wide	-	-	-
Transfers Out-COVID-19	-	-	-
Transfers Out-Star Reimagined	-	-	-
<b>Total Other Uses:</b>	<u>\$ -</u>	<u>\$ -</u>	<u>\$ -</u>
<b>Total Expenditures &amp; Other Uses:</b>	<u>\$ 770,280</u>	<u>\$ 541,602</u>	<u>\$ 570,006</u>
<b>Revenue Over/(Under) Expenditures:</b>	<u>\$ -</u>	<u>\$(119,707)</u>	<u>\$(83,682)</u>

**HARRIS COUNTY DEPARTMENT OF EDUCATION**  
**INTERIM FINANCIAL REPORTS (Unaudited)**  
**GENERAL FUNDS DETAIL BY DIVISION**  
**ACTUALS AND ENCUMBRANCES-CURRENT YEAR V. PRIOR YEAR**  
Fiscal year to date: June 30, 2021

Schedule 12

<b>Department-Wide</b>			
	CURRENT YEAR- BUDGET	CURRENT YEAR- ACTUAL REV, EXP AND ENC	PRIOR YEAR- ACTUAL REV, EXP & ENC
<b><u>REVENUES &amp; OTHER RESOURCES</u></b>			
<b>Revenues</b>			
Customer Fees/Charges	\$ 540,000	\$ -	\$ -
Local Property Tax Rev-Current	3,033,935	10,374,137	11,796,359
Local Property Tax Rev-Del, P&I	288,432	195,186	69,769
Investment Earnings	170,000	16,030	358,033
Insurance Recovery	512,211	302,570	-
FSP-Compensation	-	-	-
TEA-State Health Ins-Employee Portion	-	-	-
Local Grants	-	-	-
Other Local Revenues	-	29,820	62,810
Miscellaneous Revenues	-	21,687	1,756
Indirect Cost Rev-Local Grants	727	4,010	-
Indirect Cost Rev-State	-	-	-
Indirect Cost Rev-Federal Grants	-	-	-
<b>Total Revenues:</b>	<u>\$ 4,545,305</u>	<u>\$ 10,943,441</u>	<u>\$ 12,288,727</u>
<b>Other Resources</b>			
Local HCTO Tax Collection Fees	-	-	-
State TRS Matching	-	-	-
Transfers In-Choice Partners	2,927,240	4,152,381	2,175,939
<b>Total Other Resources:</b>	<u>\$ 2,927,240</u>	<u>\$ 4,152,381</u>	<u>\$ 2,175,939</u>
<b>Total Revenues &amp; Other Resources:</b>	<u>\$ 7,472,545</u>	<u>\$ 15,095,821</u>	<u>\$ 14,464,667</u>
<b><u>EXPENDITURES &amp; OTHER USES</u></b>			
<b>Expenditures &amp; Encumbrances</b>			
Payroll Costs	(1,401,000)	-	-
Contracted & Professional Services	2,202,457	1,673,376	1,078,337
Supplies & Materials	153,335	76,293	598,181
Other Operating Costs	4,260,528	3,227,394	2,279,372
Debt Services	-	-	-
Capital Outlay	207,492	51,520	5,182
<b>Total Expenditures &amp; Encumbrances:</b>	<u>\$ 5,422,812</u>	<u>\$ 5,028,583</u>	<u>\$ 3,961,072</u>
<b>Other Uses</b>			
Transfers Out-Special Revenue Funds	550,787	-	-
Transfers Out-Head Start Fund 205	450,000	72,983	126,227
Transfers Out-Head Start Fund 289	-	-	-
Transfers Out-Debt Service	6,469,042	3,164,984	2,824,030
Transfers Out-PFC Fund	-	-	-
Transfers Out-Department Wide	5,440,000	-	1,573,912
Transfers Out-COVID-19	-	-	135,796
Transfers Out-Star Reimagined	542,764	350,654	-
<b>Total Other Uses:</b>	<u>\$ 13,452,593</u>	<u>\$ 3,588,621</u>	<u>\$ 4,659,965</u>
<b>Total Expenditures &amp; Other Uses:</b>	<u>\$ 18,875,405</u>	<u>\$ 8,617,205</u>	<u>\$ 8,621,037</u>
<b>Revenue Over/(Under) Expenditures:</b>	<u>\$ (11,402,860)</u>	<u>\$ 6,478,617</u>	<u>\$ 5,843,630</u>

**HARRIS COUNTY DEPARTMENT OF EDUCATION**  
**INTERIM FINANCIAL REPORTS (Unaudited)**  
**GENERAL FUNDS DETAIL BY DIVISION**  
**ACTUALS AND ENCUMBRANCES-CURRENT YEAR V. PRIOR YEAR**  
Fiscal year to date: June 30, 2021

<b>Education Foundation</b>			
	CURRENT YEAR- BUDGET	CURRENT YEAR- ACTUAL REV, EXP AND ENC	PRIOR YEAR- ACTUAL REV, EXP & ENC
<b><u>REVENUES &amp; OTHER RESOURCES</u></b>			
<b>Revenues</b>			
Customer Fees/Charges	\$ -	\$ -	\$ -
Local Property Tax Rev-Current	-	-	-
Local Property Tax Rev-Del, P&I	-	-	-
Investment Earnings	-	-	-
Insurance Recovery	-	-	-
FSP-Compensation	-	-	-
TEA-State Health Ins-Employee Portion	-	-	-
Local Grants	-	-	-
Other Local Revenues	-	-	-
Miscellaneous Revenues	-	-	-
Indirect Cost Rev-Local Grants	-	-	-
Indirect Cost Rev-State	-	-	-
Indirect Cost Rev-Federal Grants	-	-	-
<b>Total Revenues:</b>	<u>\$ -</u>	<u>\$ -</u>	<u>\$ -</u>
<b>Other Resources</b>			
Local HCTO Tax Collection Fees	-	-	-
State TRS Matching	-	-	-
Transfers In-Choice Partners	-	-	-
<b>Total Other Resources:</b>	<u>\$ -</u>	<u>\$ -</u>	<u>\$ -</u>
<b>Total Revenues &amp; Other Resources:</b>	<u>\$ -</u>	<u>\$ -</u>	<u>\$ -</u>
<b><u>EXPENDITURES &amp; OTHER USES</u></b>			
<b>Expenditures &amp; Encumbrances</b>			
Payroll Costs	-	-	-
Contracted & Professional Services	9,970	7,847	500,600
Supplies & Materials	200,000	-	-
Other Operating Costs	1,109	397	-
Debt Services	-	-	-
Capital Outlay	-	-	-
<b>Total Expenditures &amp; Encumbrances:</b>	<u>\$ 211,079</u>	<u>\$ 8,244</u>	<u>\$ 500,600</u>
<b>Other Uses</b>			
Transfers Out-Special Revenue Funds	-	-	-
Transfers Out-Head Start Fund 205	-	-	-
Transfers Out-Head Start Fund 289	-	-	-
Transfers Out-Debt Service	-	-	-
Transfers Out-PFC Fund	-	-	-
Transfers Out-Department Wide	-	-	-
Transfers Out-COVID-19	-	-	-
Transfers Out-Star Reimagined	-	-	-
<b>Total Other Uses:</b>	<u>\$ -</u>	<u>\$ -</u>	<u>\$ -</u>
<b>Total Expenditures &amp; Other Uses:</b>	<u>\$ 211,079</u>	<u>\$ 8,244</u>	<u>\$ 500,600</u>
<b>Revenue Over/(Under) Expenditures:</b>	<u>\$(211,079)</u>	<u>\$(8,244)</u>	<u>\$(500,600)</u>

**HARRIS COUNTY DEPARTMENT OF EDUCATION**  
**INTERIM FINANCIAL REPORTS (Unaudited)**  
**GENERAL FUNDS DETAIL BY DIVISION**  
**ACTUALS AND ENCUMBRANCES-CURRENT YEAR V. PRIOR YEAR**  
 Fiscal year to date: June 30, 2021

<b>Chief of Staff</b>			
	CURRENT YEAR- BUDGET	CURRENT YEAR- ACTUAL REV, EXP AND ENC	PRIOR YEAR- ACTUAL REV, EXP & ENC
<b><u>REVENUES &amp; OTHER RESOURCES</u></b>			
<b>Revenues</b>			
Customer Fees/Charges	\$ -	\$ -	\$ -
Local Property Tax Rev-Current	281,956	231,372	227,660
Local Property Tax Rev-Del, P&I	-	-	-
Investment Earnings	-	-	-
Insurance Recovery	-	-	-
FSP-Compensation	-	-	-
TEA-State Health Ins-Employee Portion	-	-	-
Local Grants	-	-	-
Other Local Revenues	-	-	-
Miscellaneous Revenues	-	-	-
Indirect Cost Rev-Local Grants	-	-	-
Indirect Cost Rev-State	-	-	-
Indirect Cost Rev-Federal Grants	-	-	-
<b>Total Revenues:</b>	<u>\$ 281,956</u>	<u>\$ 231,372</u>	<u>\$ 227,660</u>
<b>Other Resources</b>			
Local HCTO Tax Collection Fees	-	-	-
State TRS Matching	-	-	-
Transfers In-Choice Partners	-	-	-
<b>Total Other Resources:</b>	<u>\$ -</u>	<u>\$ -</u>	<u>\$ -</u>
<b>Total Revenues &amp; Other Resources:</b>	<u>\$ 281,956</u>	<u>\$ 231,372</u>	<u>\$ 227,660</u>
<b><u>EXPENDITURES &amp; OTHER USES</u></b>			
<b>Expenditures &amp; Encumbrances</b>			
Payroll Costs	271,179	224,656	218,442
Contracted & Professional Services	900	686	610
Supplies & Materials	709	438	1,097
Other Operating Costs	9,168	5,593	7,511
Debt Services	-	-	-
Capital Outlay	-	-	-
<b>Total Expenditures &amp; Encumbrances:</b>	<u>\$ 281,956</u>	<u>\$ 231,372</u>	<u>\$ 227,660</u>
<b>Other Uses</b>			
Transfers Out-Special Revenue Funds	-	-	-
Transfers Out-Head Start Fund 205	-	-	-
Transfers Out-Head Start Fund 289	-	-	-
Transfers Out-Debt Service	-	-	-
Transfers Out-PFC Fund	-	-	-
Transfers Out-Department Wide	-	-	-
Transfers Out-COVID-19	-	-	-
Transfers Out-Star Reimagined	-	-	-
<b>Total Other Uses:</b>	<u>\$ -</u>	<u>\$ -</u>	<u>\$ -</u>
<b>Total Expenditures &amp; Other Uses:</b>	<u>\$ 281,956</u>	<u>\$ 231,372</u>	<u>\$ 227,660</u>
<b>Revenue Over/(Under) Expenditures:</b>	<u>\$ -</u>	<u>\$ -</u>	<u>\$ -</u>

**HARRIS COUNTY DEPARTMENT OF EDUCATION**  
**INTERIM FINANCIAL REPORTS (Unaudited)**  
**GENERAL FUNDS DETAIL BY DIVISION**  
**ACTUALS AND ENCUMBRANCES-CURRENT YEAR V. PRIOR YEAR**  
Fiscal year to date: June 30, 2021

<b>Facilities-Choice Partners Cooperative</b>
---

	CURRENT YEAR- BUDGET	CURRENT YEAR- ACTUAL REV, EXP AND ENC	PRIOR YEAR- ACTUAL REV, EXP & ENC
<b><u>REVENUES &amp; OTHER RESOURCES</u></b>			
<b>Revenues</b>			
Customer Fees/Charges	\$ -	\$ -	\$ -
Local Property Tax Rev-Current	-	-	-
Local Property Tax Rev-Del, P&I	-	-	-
Investment Earnings	-	-	-
Insurance Recovery	-	-	-
FSP-Compensation	-	-	-
TEA-State Health Ins-Employee Portion	-	-	-
Local Grants	-	-	-
Other Local Revenues	-	-	-
Miscellaneous Revenues	-	-	-
Indirect Cost Rev-Local Grants	-	-	-
Indirect Cost Rev-State	-	-	-
Indirect Cost Rev-Federal Grants	-	-	-
<b>Total Revenues:</b>	\$ -	\$ -	\$ -
<b>Other Resources</b>			
Local HCTO Tax Collection Fees	-	-	-
State TRS Matching	-	-	-
Transfers In-Choice Partners	-	-	-
<b>Total Other Resources:</b>	\$ -	\$ -	\$ -
<b>Total Revenues &amp; Other Resources:</b>	\$ -	\$ -	\$ -
<b><u>EXPENDITURES &amp; OTHER USES</u></b>			
<b>Expenditures &amp; Encumbrances</b>			
Payroll Costs	-	-	-
Contracted & Professional Services	-	-	-
Supplies & Materials	-	-	-
Other Operating Costs	-	-	-
Debt Services	-	-	-
Capital Outlay	-	-	-
<b>Total Expenditures &amp; Encumbrances:</b>	\$ -	\$ -	\$ -
<b>Other Uses</b>			
Transfers Out-Special Revenue Funds	-	-	-
Transfers Out-Head Start Fund 205	-	-	-
Transfers Out-Head Start Fund 289	-	-	-
Transfers Out-Debt Service	-	-	-
Transfers Out-PFC Fund	-	-	-
Transfers Out-Department Wide	-	-	-
Transfers Out-COVID-19	-	-	-
Transfers Out-Star Reimagined	-	-	-
<b>Total Other Uses:</b>	\$ -	\$ -	\$ -
<b>Total Expenditures &amp; Other Uses:</b>	\$ -	\$ -	\$ -
<b>Revenue Over/(Under) Expenditures:</b>	\$ -	\$ -	\$ -

**HARRIS COUNTY DEPARTMENT OF EDUCATION**  
**INTERIM FINANCIAL REPORTS (Unaudited)**  
**GENERAL FUNDS DETAIL BY DIVISION**  
**ACTUALS AND ENCUMBRANCES-CURRENT YEAR V. PRIOR YEAR**  
Fiscal year to date: June 30, 2021

Schedule 12

**Facilities-Construction Services**

	CURRENT YEAR- BUDGET	CURRENT YEAR- ACTUAL REV, EXP AND ENC	PRIOR YEAR- ACTUAL REV, EXP & ENC
<b><u>REVENUES &amp; OTHER RESOURCES</u></b>			
<b>Revenues</b>			
Customer Fees/Charges	\$ -	\$ -	\$ -
Local Property Tax Rev-Current	221,859	136,562	140,380
Local Property Tax Rev-Del, P&I	-	-	-
Investment Earnings	-	-	-
Insurance Recovery	-	-	-
FSP-Compensation	-	-	-
TEA-State Health Ins-Employee Portion	-	-	-
Local Grants	-	-	-
Other Local Revenues	-	-	-
Miscellaneous Revenues	-	-	-
Indirect Cost Rev-Local Grants	-	-	-
Indirect Cost Rev-State	-	-	-
Indirect Cost Rev-Federal Grants	-	-	-
<b>Total Revenues:</b>	<u>\$ 221,859</u>	<u>\$ 136,562</u>	<u>\$ 140,380</u>
<b>Other Resources</b>			
Local HCTO Tax Collection Fees	-	-	-
State TRS Matching	-	-	-
Transfers In-Choice Partners	-	-	-
<b>Total Other Resources:</b>	<u>\$ -</u>	<u>\$ -</u>	<u>\$ -</u>
<b>Total Revenues &amp; Other Resources:</b>	<u>\$ 221,859</u>	<u>\$ 136,562</u>	<u>\$ 140,380</u>
<b><u>EXPENDITURES &amp; OTHER USES</u></b>			
<b>Expenditures &amp; Encumbrances</b>			
Payroll Costs	195,681	131,020	134,865
Contracted & Professional Services	2,000	1,656	1,459
Supplies & Materials	3,000	-	930
Other Operating Costs	21,178	3,885	3,126
Debt Services	-	-	-
Capital Outlay	-	-	-
<b>Total Expenditures &amp; Encumbrances:</b>	<u>\$ 221,859</u>	<u>\$ 136,562</u>	<u>\$ 140,380</u>
<b>Other Uses</b>			
Transfers Out-Special Revenue Funds	-	-	-
Transfers Out-Head Start Fund 205	-	-	-
Transfers Out-Head Start Fund 289	-	-	-
Transfers Out-Debt Service	-	-	-
Transfers Out-PFC Fund	-	-	-
Transfers Out-Department Wide	-	-	-
Transfers Out-COVID-19	-	-	-
Transfers Out-Star Reimagined	-	-	-
<b>Total Other Uses:</b>	<u>\$ -</u>	<u>\$ -</u>	<u>\$ -</u>
<b>Total Expenditures &amp; Other Uses:</b>	<u>\$ 221,859</u>	<u>\$ 136,562</u>	<u>\$ 140,380</u>
<b>Revenue Over/(Under) Expenditures:</b>	<u>\$ -</u>	<u>\$ -</u>	<u>\$ -</u>

**HARRIS COUNTY DEPARTMENT OF EDUCATION**  
**INTERIM FINANCIAL REPORTS (Unaudited)**  
**GENERAL FUNDS DETAIL BY DIVISION**  
**ACTUALS AND ENCUMBRANCES-CURRENT YEAR V. PRIOR YEAR**  
Fiscal year to date: June 30, 2021

**Facilities-Facilities Support Services**

	CURRENT YEAR- BUDGET	CURRENT YEAR- ACTUAL REV, EXP AND ENC	PRIOR YEAR- ACTUAL REV, EXP & ENC
<b><u>REVENUES &amp; OTHER RESOURCES</u></b>			
<b>Revenues</b>			
Customer Fees/Charges	\$ -	\$ -	\$ -
Local Property Tax Rev-Current	-	-	-
Local Property Tax Rev-Del, P&I	-	-	-
Investment Earnings	-	-	-
Insurance Recovery	-	-	-
FSP-Compensation	-	-	-
TEA-State Health Ins-Employee Portion	-	-	-
Local Grants	-	-	-
Other Local Revenues	-	-	-
Miscellaneous Revenues	-	-	-
Indirect Cost Rev-Local Grants	-	-	-
Indirect Cost Rev-State	-	-	-
Indirect Cost Rev-Federal Grants	-	-	-
<b>Total Revenues:</b>	\$ -	\$ -	\$ -
<b>Other Resources</b>			
Local HCTO Tax Collection Fees	-	-	-
State TRS Matching	-	-	-
Transfers In-Choice Partners	-	-	-
<b>Total Other Resources:</b>	\$ -	\$ -	\$ -
<b>Total Revenues &amp; Other Resources:</b>	\$ -	\$ -	\$ -
<b><u>EXPENDITURES &amp; OTHER USES</u></b>			
<b>Expenditures &amp; Encumbrances</b>			
Payroll Costs	-	-	-
Contracted & Professional Services	-	-	-
Supplies & Materials	-	-	-
Other Operating Costs	-	-	-
Debt Services	-	-	-
Capital Outlay	-	-	-
<b>Total Expenditures &amp; Encumbrances:</b>	\$ -	\$ -	\$ -
<b>Other Uses</b>			
Transfers Out-Special Revenue Funds	-	-	-
Transfers Out-Head Start Fund 205	-	-	-
Transfers Out-Head Start Fund 289	-	-	-
Transfers Out-Debt Service	-	-	-
Transfers Out-PFC Fund	-	-	-
Transfers Out-Department Wide	-	-	-
Transfers Out-COVID-19	-	-	-
Transfers Out-Star Reimagined	-	-	-
<b>Total Other Uses:</b>	\$ -	\$ -	\$ -
<b>Total Expenditures &amp; Other Uses:</b>	\$ -	\$ -	\$ -
<b>Revenue Over/(Under) Expenditures:</b>	\$ -	\$ -	\$ -

**HARRIS COUNTY DEPARTMENT OF EDUCATION**  
**INTERIM FINANCIAL REPORTS (Unaudited)**  
**GENERAL FUNDS DETAIL BY DIVISION**  
**ACTUALS AND ENCUMBRANCES-CURRENT YEAR V. PRIOR YEAR**  
Fiscal year to date: June 30, 2021

<b>Facilities-Local Construction Fund 170</b>
---

	CURRENT YEAR- BUDGET	CURRENT YEAR- ACTUAL REV, EXP AND ENC	PRIOR YEAR- ACTUAL REV, EXP & ENC
<b><u>REVENUES &amp; OTHER RESOURCES</u></b>			
<b>Revenues</b>			
Customer Fees/Charges	\$ -	\$ -	\$ -
Local Property Tax Rev-Current	-	-	-
Local Property Tax Rev-Del, P&I	-	-	-
Investment Earnings	-	-	-
Insurance Recovery	-	-	-
FSP-Compensation	-	-	-
TEA-State Health Ins-Employee Portion	-	-	-
Local Grants	-	-	-
Other Local Revenues	-	-	-
Miscellaneous Revenues	-	-	-
Indirect Cost Rev-Local Grants	-	-	-
Indirect Cost Rev-State	-	-	-
Indirect Cost Rev-Federal Grants	-	-	-
<b>Total Revenues:</b>	\$ -	\$ -	\$ -
<b>Other Resources</b>			
Local HCTO Tax Collection Fees	-	-	-
State TRS Matching	-	-	-
Transfers In-Choice Partners	-	-	-
<b>Total Other Resources:</b>	\$ -	\$ -	\$ -
<b>Total Revenues &amp; Other Resources:</b>	\$ -	\$ -	\$ -
<b><u>EXPENDITURES &amp; OTHER USES</u></b>			
<b>Expenditures &amp; Encumbrances</b>			
Payroll Costs	-	-	-
Contracted & Professional Services	-	-	4,074
Supplies & Materials	-	-	-
Other Operating Costs	-	-	-
Debt Services	-	-	-
Capital Outlay	-	-	130,995
<b>Total Expenditures &amp; Encumbrances:</b>	\$ -	\$ -	\$ 135,069
<b>Other Uses</b>			
Transfers Out-Special Revenue Funds	-	-	-
Transfers Out-Head Start Fund 205	-	-	-
Transfers Out-Head Start Fund 289	-	-	-
Transfers Out-Debt Service	-	-	-
Transfers Out-PFC Fund	-	-	-
Transfers Out-Department Wide	-	-	-
Transfers Out-COVID-19	-	-	-
Transfers Out-Star Reimagined	-	-	-
<b>Total Other Uses:</b>	\$ -	\$ -	\$ -
<b>Total Expenditures &amp; Other Uses:</b>	\$ -	\$ -	\$ 135,069
<b>Revenue Over/(Under) Expenditures:</b>	\$ -	\$ -	\$(135,069)



**HARRIS COUNTY DEPARTMENT OF EDUCATION**  
**INTERIM FINANCIAL REPORTS (Unaudited)**  
**GENERAL FUNDS DETAIL BY DIVISION**  
**ACTUALS AND ENCUMBRANCES-CURRENT YEAR V. PRIOR YEAR**  
 Fiscal year to date: June 30, 2021

<b>Facilities-Building Replacement Schedule</b>
---

	CURRENT YEAR- BUDGET	CURRENT YEAR- ACTUAL REV, EXP AND ENC	PRIOR YEAR- ACTUAL REV, EXP & ENC
<b><u>REVENUES &amp; OTHER RESOURCES</u></b>			
<b>Revenues</b>			
Customer Fees/Charges	\$ -	\$ -	\$ -
Local Property Tax Rev-Current	-	-	92,444
Local Property Tax Rev-Del, P&I	-	-	-
Investment Earnings	-	-	-
Insurance Recovery	-	-	-
FSP-Compensation	-	-	-
TEA-State Health Ins-Employee Portion	-	-	-
Local Grants	-	-	-
Other Local Revenues	-	-	-
Miscellaneous Revenues	-	-	-
Indirect Cost Rev-Local Grants	-	-	-
Indirect Cost Rev-State	-	-	-
Indirect Cost Rev-Federal Grants	-	-	-
<b>Total Revenues:</b>	\$ -	\$ -	\$ 92,444
<b>Other Resources</b>			
Local HCTO Tax Collection Fees	-	-	-
State TRS Matching	-	-	-
Transfers In-Choice Partners	-	-	-
<b>Total Other Resources:</b>	\$ -	\$ -	\$ -
<b>Total Revenues &amp; Other Resources:</b>	\$ -	\$ -	\$ 92,444
<b><u>EXPENDITURES &amp; OTHER USES</u></b>			
<b>Expenditures &amp; Encumbrances</b>			
Payroll Costs	-	-	-
Contracted & Professional Services	-	-	-
Supplies & Materials	-	-	-
Other Operating Costs	-	-	-
Debt Services	-	-	-
Capital Outlay	-	-	92,444
<b>Total Expenditures &amp; Encumbrances:</b>	\$ -	\$ -	\$ 92,444
<b>Other Uses</b>			
Transfers Out-Special Revenue Funds	-	-	-
Transfers Out-Head Start Fund 205	-	-	-
Transfers Out-Head Start Fund 289	-	-	-
Transfers Out-Debt Service	-	-	-
Transfers Out-PFC Fund	-	-	-
Transfers Out-Department Wide	-	-	-
Transfers Out-COVID-19	-	-	-
Transfers Out-Star Reimagined	-	-	-
<b>Total Other Uses:</b>	\$ -	\$ -	\$ -
<b>Total Expenditures &amp; Other Uses:</b>	\$ -	\$ -	\$ 92,444
<b>Revenue Over/(Under) Expenditures:</b>	\$ -	\$ -	\$ -

**HARRIS COUNTY DEPARTMENT OF EDUCATION**  
**INTERIM FINANCIAL REPORTS (Unaudited)**  
**GENERAL FUNDS DETAIL BY DIVISION**  
**ACTUALS AND ENCUMBRANCES-CURRENT YEAR V. PRIOR YEAR**  
Fiscal year to date: June 30, 2021

Schedule 12

**Facilities-Records Management Services**

	CURRENT YEAR- BUDGET	CURRENT YEAR- ACTUAL REV, EXP AND ENC	PRIOR YEAR- ACTUAL REV, EXP & ENC
<b><u>REVENUES &amp; OTHER RESOURCES</u></b>			
<b>Revenues</b>			
Customer Fees/Charges	\$ 1,710,500	\$ 1,090,522	\$ 1,326,396
Local Property Tax Rev-Current	221,282	339,221	103,825
Local Property Tax Rev-Del, P&I	-	-	-
Investment Earnings	-	-	-
Insurance Recovery	-	-	-
FSP-Compensation	-	-	-
TEA-State Health Ins-Employee Portion	-	-	-
Local Grants	-	-	-
Other Local Revenues	90,000	28,981	56,360
Miscellaneous Revenues	-	-	-
Indirect Cost Rev-Local Grants	-	-	-
Indirect Cost Rev-State	-	-	-
Indirect Cost Rev-Federal Grants	-	-	-
<b>Total Revenues:</b>	<u>\$ 2,021,782</u>	<u>\$ 1,458,723</u>	<u>\$ 1,486,581</u>
<b>Other Resources</b>			
Local HCTO Tax Collection Fees	-	-	-
State TRS Matching	-	-	-
Transfers In-Choice Partners	-	-	106,827
<b>Total Other Resources:</b>	<u>\$ -</u>	<u>\$ -</u>	<u>\$ 106,827</u>
<b>Total Revenues &amp; Other Resources:</b>	<u>\$ 2,021,782</u>	<u>\$ 1,458,723</u>	<u>\$ 1,593,408</u>
<b><u>EXPENDITURES &amp; OTHER USES</u></b>			
<b>Expenditures &amp; Encumbrances</b>			
Payroll Costs	960,806	724,830	714,432
Contracted & Professional Services	131,757	59,879	73,612
Supplies & Materials	180,830	105,829	144,041
Other Operating Costs	773,397	587,011	605,452
Debt Services	-	-	-
Capital Outlay	12,600	12,600	-
<b>Total Expenditures &amp; Encumbrances:</b>	<u>\$ 2,059,390</u>	<u>\$ 1,490,148</u>	<u>\$ 1,537,536</u>
<b>Other Uses</b>			
Transfers Out-Special Revenue Funds	-	-	-
Transfers Out-Head Start Fund 205	-	-	-
Transfers Out-Head Start Fund 289	-	-	-
Transfers Out-Debt Service	-	-	-
Transfers Out-PFC Fund	-	-	-
Transfers Out-Department Wide	-	-	-
Transfers Out-COVID-19	-	-	-
Transfers Out-Star Reimagined	-	-	-
<b>Total Other Uses:</b>	<u>\$ -</u>	<u>\$ -</u>	<u>\$ -</u>
<b>Total Expenditures &amp; Other Uses:</b>	<u>\$ 2,059,390</u>	<u>\$ 1,490,148</u>	<u>\$ 1,537,536</u>
<b>Revenue Over/(Under) Expenditures:</b>	<u>\$(37,608)</u>	<u>\$(31,425)</u>	<u>\$ 55,872</u>

**HARRIS COUNTY DEPARTMENT OF EDUCATION**  
**INTERIM FINANCIAL REPORTS (Unaudited)**  
**GENERAL FUNDS DETAIL BY DIVISION**  
**ACTUALS AND ENCUMBRANCES-CURRENT YEAR V. PRIOR YEAR**  
Fiscal year to date: June 30, 2021

<b>Head Start-Local</b>			
	CURRENT YEAR- BUDGET	CURRENT YEAR- ACTUAL REV, EXP AND ENC	PRIOR YEAR- ACTUAL REV, EXP & ENC
<b><u>REVENUES &amp; OTHER RESOURCES</u></b>			
<b>Revenues</b>			
Customer Fees/Charges	\$ -	\$ -	\$ -
Local Property Tax Rev-Current	8,000	-	2,221
Local Property Tax Rev-Del, P&I	-	-	-
Investment Earnings	-	-	-
Insurance Recovery	-	-	-
FSP-Compensation	-	-	-
TEA-State Health Ins-Employee Portion	-	-	-
Local Grants	-	-	-
Other Local Revenues	-	-	-
Miscellaneous Revenues	-	-	-
Indirect Cost Rev-Local Grants	-	-	-
Indirect Cost Rev-State	-	-	-
Indirect Cost Rev-Federal Grants	-	-	-
<b>Total Revenues:</b>	<u>\$ 8,000</u>	<u>\$ -</u>	<u>\$ 2,221</u>
<b>Other Resources</b>			
Local HCTO Tax Collection Fees	-	-	-
State TRS Matching	-	-	-
Transfers In-Choice Partners	-	-	-
<b>Total Other Resources:</b>	<u>\$ -</u>	<u>\$ -</u>	<u>\$ -</u>
<b>Total Revenues &amp; Other Resources:</b>	<u>\$ 8,000</u>	<u>\$ -</u>	<u>\$ 2,221</u>
<b><u>EXPENDITURES &amp; OTHER USES</u></b>			
<b>Expenditures &amp; Encumbrances</b>			
Payroll Costs	-	-	-
Contracted & Professional Services	-	-	-
Supplies & Materials	-	-	-
Other Operating Costs	8,000	-	2,221
Debt Services	-	-	-
Capital Outlay	-	-	-
<b>Total Expenditures &amp; Encumbrances:</b>	<u>\$ 8,000</u>	<u>\$ -</u>	<u>\$ 2,221</u>
<b>Other Uses</b>			
Transfers Out-Special Revenue Funds	-	-	-
Transfers Out-Head Start Fund 205	-	-	-
Transfers Out-Head Start Fund 289	-	-	-
Transfers Out-Debt Service	-	-	-
Transfers Out-PFC Fund	-	-	-
Transfers Out-Department Wide	-	-	-
Transfers Out-COVID-19	-	-	-
Transfers Out-Star Reimagined	-	-	-
<b>Total Other Uses:</b>	<u>\$ -</u>	<u>\$ -</u>	<u>\$ -</u>
<b>Total Expenditures &amp; Other Uses:</b>	<u>\$ 8,000</u>	<u>\$ -</u>	<u>\$ 2,221</u>
<b>Revenue Over/(Under) Expenditures:</b>	<u>\$ -</u>	<u>\$ -</u>	<u>\$ -</u>

**HARRIS COUNTY DEPARTMENT OF EDUCATION**  
**INTERIM FINANCIAL REPORTS (Unaudited)**  
**GENERAL FUNDS DETAIL BY DIVISION**  
**ACTUALS AND ENCUMBRANCES-CURRENT YEAR V. PRIOR YEAR**  
Fiscal year to date: June 30, 2021

Schedule 12

<b>Human Resources</b>			
	CURRENT YEAR- BUDGET	CURRENT YEAR- ACTUAL REV, EXP AND ENC	PRIOR YEAR- ACTUAL REV, EXP & ENC
<b><u>REVENUES &amp; OTHER RESOURCES</u></b>			
<b>Revenues</b>			
Customer Fees/Charges	\$ -	\$ -	\$ -
Local Property Tax Rev-Current	731,116	619,540	615,861
Local Property Tax Rev-Del, P&I	-	-	-
Investment Earnings	-	-	-
Insurance Recovery	-	-	-
FSP-Compensation	-	-	-
TEA-State Health Ins-Employee Portion	-	-	-
Local Grants	-	-	-
Other Local Revenues	-	-	-
Miscellaneous Revenues	-	-	-
Indirect Cost Rev-Local Grants	-	-	-
Indirect Cost Rev-State	-	-	-
Indirect Cost Rev-Federal Grants	368,904	233,202	218,883
<b>Total Revenues:</b>	<u>\$ 1,100,020</u>	<u>\$ 852,743</u>	<u>\$ 834,744</u>
<b>Other Resources</b>			
Local HCTO Tax Collection Fees	-	-	-
State TRS Matching	-	-	-
Transfers In-Choice Partners	-	-	-
<b>Total Other Resources:</b>	<u>\$ -</u>	<u>\$ -</u>	<u>\$ -</u>
<b>Total Revenues &amp; Other Resources:</b>	<u>\$ 1,100,020</u>	<u>\$ 852,743</u>	<u>\$ 834,744</u>
<b><u>EXPENDITURES &amp; OTHER USES</u></b>			
<b>Expenditures &amp; Encumbrances</b>			
Payroll Costs	866,613	732,487	719,044
Contracted & Professional Services	64,509	56,406	51,736
Supplies & Materials	65,719	36,642	49,823
Other Operating Costs	103,179	75,004	52,563
Debt Services	-	-	-
Capital Outlay	-	-	-
<b>Total Expenditures &amp; Encumbrances:</b>	<u>\$ 1,100,020</u>	<u>\$ 900,540</u>	<u>\$ 873,166</u>
<b>Other Uses</b>			
Transfers Out-Special Revenue Funds	-	-	-
Transfers Out-Head Start Fund 205	-	-	-
Transfers Out-Head Start Fund 289	-	-	-
Transfers Out-Debt Service	-	-	-
Transfers Out-PFC Fund	-	-	-
Transfers Out-Department Wide	-	-	-
Transfers Out-COVID-19	-	-	-
Transfers Out-Star Reimagined	-	-	-
<b>Total Other Uses:</b>	<u>\$ -</u>	<u>\$ -</u>	<u>\$ -</u>
<b>Total Expenditures &amp; Other Uses:</b>	<u>\$ 1,100,020</u>	<u>\$ 900,540</u>	<u>\$ 873,166</u>
<b>Revenue Over/(Under) Expenditures:</b>	<u>\$ -</u>	<u>\$(47,798)</u>	<u>\$(38,422)</u>

**HARRIS COUNTY DEPARTMENT OF EDUCATION**  
**INTERIM FINANCIAL REPORTS (Unaudited)**  
**GENERAL FUNDS DETAIL BY DIVISION**  
**ACTUALS AND ENCUMBRANCES-CURRENT YEAR V. PRIOR YEAR**  
Fiscal year to date: June 30, 2021

Schedule 12

**The Teaching and Learning Center-Bilingual Education**

	CURRENT YEAR- BUDGET	CURRENT YEAR- ACTUAL REV, EXP AND ENC	PRIOR YEAR- ACTUAL REV, EXP & ENC
<b><u>REVENUES &amp; OTHER RESOURCES</u></b>			
<b>Revenues</b>			
Customer Fees/Charges	\$ 77,000	\$ 54,295	\$ 34,955
Local Property Tax Rev-Current	79,270	8,354	46,514
Local Property Tax Rev-Del, P&I	-	-	-
Investment Earnings	-	-	-
Insurance Recovery	-	-	-
FSP-Compensation	-	-	-
TEA-State Health Ins-Employee Portion	-	-	-
Local Grants	-	-	-
Other Local Revenues	-	-	-
Miscellaneous Revenues	-	-	-
Indirect Cost Rev-Local Grants	-	-	-
Indirect Cost Rev-State	-	-	-
Indirect Cost Rev-Federal Grants	-	-	-
<b>Total Revenues:</b>	\$ 156,270	\$ 62,649	\$ 81,469
<b>Other Resources</b>			
Local HCTO Tax Collection Fees	-	-	-
State TRS Matching	-	-	-
Transfers In-Choice Partners	-	-	-
<b>Total Other Resources:</b>	\$ -	\$ -	\$ -
<b>Total Revenues &amp; Other Resources:</b>	\$ 156,270	\$ 62,649	\$ 81,469
<b><u>EXPENDITURES &amp; OTHER USES</u></b>			
<b>Expenditures &amp; Encumbrances</b>			
Payroll Costs	67,952	55,727	55,551
Contracted & Professional Services	49,962	343	33,618
Supplies & Materials	23,021	5,331	5,995
Other Operating Costs	15,335	1,248	1,480
Debt Services	-	-	-
Capital Outlay	-	-	-
<b>Total Expenditures &amp; Encumbrances:</b>	\$ 156,270	\$ 62,649	\$ 96,644
<b>Other Uses</b>			
Transfers Out-Special Revenue Funds	-	-	-
Transfers Out-Head Start Fund 205	-	-	-
Transfers Out-Head Start Fund 289	-	-	-
Transfers Out-Debt Service	-	-	-
Transfers Out-PFC Fund	-	-	-
Transfers Out-Department Wide	-	-	-
Transfers Out-COVID-19	-	-	-
Transfers Out-Star Reimagined	-	-	-
<b>Total Other Uses:</b>	\$ -	\$ -	\$ -
<b>Total Expenditures &amp; Other Uses:</b>	\$ 156,270	\$ 62,649	\$ 96,644
<b>Revenue Over/(Under) Expenditures:</b>	\$ -	\$ -	\$(15,175)

**HARRIS COUNTY DEPARTMENT OF EDUCATION**  
**INTERIM FINANCIAL REPORTS (Unaudited)**  
**GENERAL FUNDS DETAIL BY DIVISION**  
**ACTUALS AND ENCUMBRANCES-CURRENT YEAR V. PRIOR YEAR**  
 Fiscal year to date: June 30, 2021

<b>The Teaching and Learning Center-Digital Learning</b>
--

	CURRENT YEAR- BUDGET	CURRENT YEAR- ACTUAL REV, EXP AND ENC	PRIOR YEAR- ACTUAL REV, EXP & ENC
<b><u>REVENUES &amp; OTHER RESOURCES</u></b>			
<b>Revenues</b>			
Customer Fees/Charges	\$ -	\$ -	\$ -
Local Property Tax Rev-Current	-	-	-
Local Property Tax Rev-Del, P&I	-	-	-
Investment Earnings	-	-	-
Insurance Recovery	-	-	-
FSP-Compensation	-	-	-
TEA-State Health Ins-Employee Portion	-	-	-
Local Grants	-	-	-
Other Local Revenues	-	-	-
Miscellaneous Revenues	-	-	-
Indirect Cost Rev-Local Grants	-	-	-
Indirect Cost Rev-State	-	-	-
Indirect Cost Rev-Federal Grants	-	-	-
<b>Total Revenues:</b>	\$ -	\$ -	\$ -
<b>Other Resources</b>			
Local HCTO Tax Collection Fees	-	-	-
State TRS Matching	-	-	-
Transfers In-Choice Partners	-	-	-
<b>Total Other Resources:</b>	\$ -	\$ -	\$ -
<b>Total Revenues &amp; Other Resources:</b>	\$ -	\$ -	\$ -
<b><u>EXPENDITURES &amp; OTHER USES</u></b>			
<b>Expenditures &amp; Encumbrances</b>			
Payroll Costs	-	-	-
Contracted & Professional Services	-	-	-
Supplies & Materials	-	-	-
Other Operating Costs	-	-	-
Debt Services	-	-	-
Capital Outlay	-	-	-
<b>Total Expenditures &amp; Encumbrances:</b>	\$ -	\$ -	\$ -
<b>Other Uses</b>			
Transfers Out-Special Revenue Funds	-	-	-
Transfers Out-Head Start Fund 205	-	-	-
Transfers Out-Head Start Fund 289	-	-	-
Transfers Out-Debt Service	-	-	-
Transfers Out-PFC Fund	-	-	-
Transfers Out-Department Wide	-	-	-
Transfers Out-COVID-19	-	-	-
Transfers Out-Star Reimagined	-	-	-
<b>Total Other Uses:</b>	\$ -	\$ -	\$ -
<b>Total Expenditures &amp; Other Uses:</b>	\$ -	\$ -	\$ -
<b>Revenue Over/(Under) Expenditures:</b>	\$ -	\$ -	\$ -

**HARRIS COUNTY DEPARTMENT OF EDUCATION**  
**INTERIM FINANCIAL REPORTS (Unaudited)**  
**GENERAL FUNDS DETAIL BY DIVISION**  
**ACTUALS AND ENCUMBRANCES-CURRENT YEAR V. PRIOR YEAR**  
Fiscal year to date: June 30, 2021

Schedule 12

**The Teaching and Learning Center-Digital Education and Innovation**

	CURRENT YEAR- BUDGET	CURRENT YEAR- ACTUAL REV, EXP AND ENC	PRIOR YEAR- ACTUAL REV, EXP & ENC
<b><u>REVENUES &amp; OTHER RESOURCES</u></b>			
<b>Revenues</b>			
Customer Fees/Charges	\$ 236,000	\$ 167,544	\$ 412,827
Local Property Tax Rev-Current	75,442	65,988	-
Local Property Tax Rev-Del, P&I	-	-	-
Investment Earnings	-	-	-
Insurance Recovery	-	-	-
FSP-Compensation	-	-	-
TEA-State Health Ins-Employee Portion	-	-	-
Local Grants	-	-	-
Other Local Revenues	-	-	-
Miscellaneous Revenues	-	-	-
Indirect Cost Rev-Local Grants	-	-	-
Indirect Cost Rev-State	-	-	-
Indirect Cost Rev-Federal Grants	-	-	-
<b>Total Revenues:</b>	<u>\$ 311,442</u>	<u>\$ 233,532</u>	<u>\$ 412,827</u>
<b>Other Resources</b>			
Local HCTO Tax Collection Fees	-	-	-
State TRS Matching	-	-	-
Transfers In-Choice Partners	-	-	-
<b>Total Other Resources:</b>	<u>\$ -</u>	<u>\$ -</u>	<u>\$ -</u>
<b>Total Revenues &amp; Other Resources:</b>	<u>\$ 311,442</u>	<u>\$ 233,532</u>	<u>\$ 412,827</u>
<b><u>EXPENDITURES &amp; OTHER USES</u></b>			
<b>Expenditures &amp; Encumbrances</b>			
Payroll Costs	242,902	180,267	181,844
Contracted & Professional Services	37,430	29,530	55,398
Supplies & Materials	11,690	9,526	9,251
Other Operating Costs	19,420	14,209	104,419
Debt Services	-	-	-
Capital Outlay	-	-	-
<b>Total Expenditures &amp; Encumbrances:</b>	<u>\$ 311,442</u>	<u>\$ 233,532</u>	<u>\$ 350,913</u>
<b>Other Uses</b>			
Transfers Out-Special Revenue Funds	-	-	-
Transfers Out-Head Start Fund 205	-	-	-
Transfers Out-Head Start Fund 289	-	-	-
Transfers Out-Debt Service	-	-	-
Transfers Out-PFC Fund	-	-	-
Transfers Out-Department Wide	-	-	-
Transfers Out-COVID-19	-	-	-
Transfers Out-Star Reimagined	-	-	-
<b>Total Other Uses:</b>	<u>\$ -</u>	<u>\$ -</u>	<u>\$ -</u>
<b>Total Expenditures &amp; Other Uses:</b>	<u>\$ 311,442</u>	<u>\$ 233,532</u>	<u>\$ 350,913</u>
<b>Revenue Over/(Under) Expenditures:</b>	<u>\$ -</u>	<u>\$ -</u>	<u>\$ 61,914</u>

**HARRIS COUNTY DEPARTMENT OF EDUCATION**  
**INTERIM FINANCIAL REPORTS (Unaudited)**  
**GENERAL FUNDS DETAIL BY DIVISION**  
**ACTUALS AND ENCUMBRANCES-CURRENT YEAR V. PRIOR YEAR**  
 Fiscal year to date: June 30, 2021

Schedule 12

**The Teaching and Learning Center-TLC (Division Wide)**

	CURRENT YEAR- BUDGET	CURRENT YEAR- ACTUAL REV, EXP AND ENC	PRIOR YEAR- ACTUAL REV, EXP & ENC
<b><u>REVENUES &amp; OTHER RESOURCES</u></b>			
<b>Revenues</b>			
Customer Fees/Charges	\$ -	\$ -	\$ -
Local Property Tax Rev-Current	315,754	137,883	234,048
Local Property Tax Rev-Del, P&I	-	-	-
Investment Earnings	-	-	-
Insurance Recovery	-	-	-
FSP-Compensation	-	-	-
TEA-State Health Ins-Employee Portion	-	-	-
Local Grants	-	-	-
Other Local Revenues	-	-	-
Miscellaneous Revenues	-	-	-
Indirect Cost Rev-Local Grants	-	-	-
Indirect Cost Rev-State	-	-	-
Indirect Cost Rev-Federal Grants	-	-	-
<b>Total Revenues:</b>	<u>\$ 315,754</u>	<u>\$ 137,883</u>	<u>\$ 234,048</u>
<b>Other Resources</b>			
Local HCTO Tax Collection Fees	-	-	-
State TRS Matching	-	-	-
Transfers In-Choice Partners	-	-	-
<b>Total Other Resources:</b>	<u>\$ -</u>	<u>\$ -</u>	<u>\$ -</u>
<b>Total Revenues &amp; Other Resources:</b>	<u>\$ 315,754</u>	<u>\$ 137,883</u>	<u>\$ 234,048</u>
<b><u>EXPENDITURES &amp; OTHER USES</u></b>			
<b>Expenditures &amp; Encumbrances</b>			
Payroll Costs	249,440	96,614	190,686
Contracted & Professional Services	9,599	9,307	697
Supplies & Materials	11,743	8,514	5,381
Other Operating Costs	44,972	32,146	37,966
Debt Services	-	-	-
Capital Outlay	-	-	-
<b>Total Expenditures &amp; Encumbrances:</b>	<u>\$ 315,754</u>	<u>\$ 146,580</u>	<u>\$ 234,730</u>
<b>Other Uses</b>			
Transfers Out-Special Revenue Funds	-	-	-
Transfers Out-Head Start Fund 205	-	-	-
Transfers Out-Head Start Fund 289	-	-	-
Transfers Out-Debt Service	-	-	-
Transfers Out-PFC Fund	-	-	-
Transfers Out-Department Wide	-	-	-
Transfers Out-COVID-19	-	-	-
Transfers Out-Star Reimagined	-	-	-
<b>Total Other Uses:</b>	<u>\$ -</u>	<u>\$ -</u>	<u>\$ -</u>
<b>Total Expenditures &amp; Other Uses:</b>	<u>\$ 315,754</u>	<u>\$ 146,580</u>	<u>\$ 234,730</u>
<b>Revenue Over/(Under) Expenditures:</b>	<u>\$ -</u>	<u>\$(8,697)</u>	<u>\$(683)</u>



**HARRIS COUNTY DEPARTMENT OF EDUCATION**  
**INTERIM FINANCIAL REPORTS (Unaudited)**  
**GENERAL FUNDS DETAIL BY DIVISION**  
**ACTUALS AND ENCUMBRANCES-CURRENT YEAR V. PRIOR YEAR**  
Fiscal year to date: June 30, 2021

**The Teaching and Learning Center-Early Childhood Winter Conference**

	CURRENT YEAR- BUDGET	CURRENT YEAR- ACTUAL REV, EXP AND ENC	PRIOR YEAR- ACTUAL REV, EXP & ENC
<b>REVENUES &amp; OTHER RESOURCES</b>			
<b>Revenues</b>			
Customer Fees/Charges	\$ 85,000	\$ 62,276	\$ 89,755
Local Property Tax Rev-Current	58,507	5,787	30,645
Local Property Tax Rev-Del, P&I	-	-	-
Investment Earnings	-	-	-
Insurance Recovery	-	-	-
FSP-Compensation	-	-	-
TEA-State Health Ins-Employee Portion	-	-	-
Local Grants	-	-	-
Other Local Revenues	-	-	500
Miscellaneous Revenues	-	-	-
Indirect Cost Rev-Local Grants	-	-	-
Indirect Cost Rev-State	-	-	-
Indirect Cost Rev-Federal Grants	-	-	-
<b>Total Revenues:</b>	<b>\$ 143,507</b>	<b>\$ 68,062</b>	<b>\$ 120,900</b>
<b>Other Resources</b>			
Local HCTO Tax Collection Fees	-	-	-
State TRS Matching	-	-	-
Transfers In-Choice Partners	-	-	-
<b>Total Other Resources:</b>	<b>\$ -</b>	<b>\$ -</b>	<b>\$ -</b>
<b>Total Revenues &amp; Other Resources:</b>	<b>\$ 143,507</b>	<b>\$ 68,062</b>	<b>\$ 120,900</b>
<b>EXPENDITURES &amp; OTHER USES</b>			
<b>Expenditures &amp; Encumbrances</b>			
Payroll Costs	48,807	33,981	40,776
Contracted & Professional Services	62,700	33,700	54,590
Supplies & Materials	11,200	-	7,434
Other Operating Costs	20,800	381	18,100
Debt Services	-	-	-
Capital Outlay	-	-	-
<b>Total Expenditures &amp; Encumbrances:</b>	<b>\$ 143,507</b>	<b>\$ 68,062</b>	<b>\$ 120,900</b>
<b>Other Uses</b>			
Transfers Out-Special Revenue Funds	-	-	-
Transfers Out-Head Start Fund 205	-	-	-
Transfers Out-Head Start Fund 289	-	-	-
Transfers Out-Debt Service	-	-	-
Transfers Out-PFC Fund	-	-	-
Transfers Out-Department Wide	-	-	-
Transfers Out-COVID-19	-	-	-
Transfers Out-Star Reimagined	-	-	-
<b>Total Other Uses:</b>	<b>\$ -</b>	<b>\$ -</b>	<b>\$ -</b>
<b>Total Expenditures &amp; Other Uses:</b>	<b>\$ 143,507</b>	<b>\$ 68,062</b>	<b>\$ 120,900</b>
<b>Revenue Over/(Under) Expenditures:</b>	<b>\$ -</b>	<b>\$ -</b>	<b>\$ -</b>

**HARRIS COUNTY DEPARTMENT OF EDUCATION**  
**INTERIM FINANCIAL REPORTS (Unaudited)**  
**GENERAL FUNDS DETAIL BY DIVISION**  
**ACTUALS AND ENCUMBRANCES-CURRENT YEAR V. PRIOR YEAR**  
 Fiscal year to date: June 30, 2021

Schedule 12

**The Teaching and Learning Center-English Language Arts**

	CURRENT YEAR- BUDGET	CURRENT YEAR- ACTUAL REV, EXP AND ENC	PRIOR YEAR- ACTUAL REV, EXP & ENC
<b><u>REVENUES &amp; OTHER RESOURCES</u></b>			
<b>Revenues</b>			
Customer Fees/Charges	\$ 104,500	\$ 59,828	\$ 85,492
Local Property Tax Rev-Current	90,538	57,314	37,698
Local Property Tax Rev-Del, P&I	-	-	-
Investment Earnings	-	-	-
Insurance Recovery	-	-	-
FSP-Compensation	-	-	-
TEA-State Health Ins-Employee Portion	-	-	-
Local Grants	-	-	-
Other Local Revenues	-	-	-
Miscellaneous Revenues	-	-	-
Indirect Cost Rev-Local Grants	-	-	-
Indirect Cost Rev-State	-	-	-
Indirect Cost Rev-Federal Grants	-	-	-
<b>Total Revenues:</b>	<u>\$ 195,038</u>	<u>\$ 117,141</u>	<u>\$ 123,190</u>
<b>Other Resources</b>			
Local HCTO Tax Collection Fees	-	-	-
State TRS Matching	-	-	-
Transfers In-Choice Partners	-	-	-
<b>Total Other Resources:</b>	<u>\$ -</u>	<u>\$ -</u>	<u>\$ -</u>
<b>Total Revenues &amp; Other Resources:</b>	<u>\$ 195,038</u>	<u>\$ 117,141</u>	<u>\$ 123,190</u>
<b><u>EXPENDITURES &amp; OTHER USES</u></b>			
<b>Expenditures &amp; Encumbrances</b>			
Payroll Costs	104,949	86,887	84,725
Contracted & Professional Services	25,132	12,753	30,943
Supplies & Materials	28,757	14,419	9,909
Other Operating Costs	36,200	7,281	8,321
Debt Services	-	-	-
Capital Outlay	-	-	-
<b>Total Expenditures &amp; Encumbrances:</b>	<u>\$ 195,038</u>	<u>\$ 121,341</u>	<u>\$ 133,898</u>
<b>Other Uses</b>			
Transfers Out-Special Revenue Funds	-	-	-
Transfers Out-Head Start Fund 205	-	-	-
Transfers Out-Head Start Fund 289	-	-	-
Transfers Out-Debt Service	-	-	-
Transfers Out-PFC Fund	-	-	-
Transfers Out-Department Wide	-	-	-
Transfers Out-COVID-19	-	-	-
Transfers Out-Star Reimagined	-	-	-
<b>Total Other Uses:</b>	<u>\$ -</u>	<u>\$ -</u>	<u>\$ -</u>
<b>Total Expenditures &amp; Other Uses:</b>	<u>\$ 195,038</u>	<u>\$ 121,341</u>	<u>\$ 133,898</u>
<b>Revenue Over/(Under) Expenditures:</b>	<u>\$ -</u>	<u>\$(4,200)</u>	<u>\$(10,708)</u>

**HARRIS COUNTY DEPARTMENT OF EDUCATION**  
**INTERIM FINANCIAL REPORTS (Unaudited)**  
**GENERAL FUNDS DETAIL BY DIVISION**  
**ACTUALS AND ENCUMBRANCES-CURRENT YEAR V. PRIOR YEAR**  
Fiscal year to date: June 30, 2021

Schedule 12

**The Teaching and Learning Center-Math**

	CURRENT YEAR- BUDGET	CURRENT YEAR- ACTUAL REV, EXP AND ENC	PRIOR YEAR- ACTUAL REV, EXP & ENC
<b><u>REVENUES &amp; OTHER RESOURCES</u></b>			
<b>Revenues</b>			
Customer Fees/Charges	\$ 168,000	\$ 61,249	\$ 52,855
Local Property Tax Rev-Current	53,867	72,521	87,718
Local Property Tax Rev-Del, P&I	-	-	-
Investment Earnings	-	-	-
Insurance Recovery	-	-	-
FSP-Compensation	-	-	-
TEA-State Health Ins-Employee Portion	-	-	-
Local Grants	-	-	-
Other Local Revenues	-	-	-
Miscellaneous Revenues	-	-	-
Indirect Cost Rev-Local Grants	-	-	-
Indirect Cost Rev-State	-	-	-
Indirect Cost Rev-Federal Grants	-	-	-
<b>Total Revenues:</b>	<u>\$ 221,867</u>	<u>\$ 133,770</u>	<u>\$ 140,573</u>
<b>Other Resources</b>			
Local HCTO Tax Collection Fees	-	-	-
State TRS Matching	-	-	-
Transfers In-Choice Partners	-	-	-
<b>Total Other Resources:</b>	<u>\$ -</u>	<u>\$ -</u>	<u>\$ -</u>
<b>Total Revenues &amp; Other Resources:</b>	<u>\$ 221,867</u>	<u>\$ 133,770</u>	<u>\$ 140,573</u>
<b><u>EXPENDITURES &amp; OTHER USES</u></b>			
<b>Expenditures &amp; Encumbrances</b>			
Payroll Costs	139,873	115,851	113,171
Contracted & Professional Services	55,760	52,843	34,793
Supplies & Materials	5,310	1,206	3,334
Other Operating Costs	20,924	720	5,719
Debt Services	-	-	-
Capital Outlay	-	-	-
<b>Total Expenditures &amp; Encumbrances:</b>	<u>\$ 221,867</u>	<u>\$ 170,620</u>	<u>\$ 157,016</u>
<b>Other Uses</b>			
Transfers Out-Special Revenue Funds	-	-	-
Transfers Out-Head Start Fund 205	-	-	-
Transfers Out-Head Start Fund 289	-	-	-
Transfers Out-Debt Service	-	-	-
Transfers Out-PFC Fund	-	-	-
Transfers Out-Department Wide	-	-	-
Transfers Out-COVID-19	-	-	-
Transfers Out-Star Reimagined	-	-	-
<b>Total Other Uses:</b>	<u>\$ -</u>	<u>\$ -</u>	<u>\$ -</u>
<b>Total Expenditures &amp; Other Uses:</b>	<u>\$ 221,867</u>	<u>\$ 170,620</u>	<u>\$ 157,016</u>
<b>Revenue Over/(Under) Expenditures:</b>	<u>\$ -</u>	<u>\$(36,850)</u>	<u>\$(16,443)</u>

**HARRIS COUNTY DEPARTMENT OF EDUCATION**  
**INTERIM FINANCIAL REPORTS (Unaudited)**  
**GENERAL FUNDS DETAIL BY DIVISION**  
**ACTUALS AND ENCUMBRANCES-CURRENT YEAR V. PRIOR YEAR**  
Fiscal year to date: June 30, 2021

**The Teaching and Learning Center-Professional Development**

	CURRENT YEAR- BUDGET	CURRENT YEAR- ACTUAL REV, EXP AND ENC	PRIOR YEAR- ACTUAL REV, EXP & ENC
<b><u>REVENUES &amp; OTHER RESOURCES</u></b>			
<b>Revenues</b>			
Customer Fees/Charges	\$ -	\$ 3,500	\$ 11,382
Local Property Tax Rev-Current	-	-	-
Local Property Tax Rev-Del, P&I	-	-	-
Investment Earnings	-	-	-
Insurance Recovery	-	-	-
FSP-Compensation	-	-	-
TEA-State Health Ins-Employee Portion	-	-	-
Local Grants	-	-	-
Other Local Revenues	-	-	-
Miscellaneous Revenues	-	-	-
Indirect Cost Rev-Local Grants	-	-	-
Indirect Cost Rev-State	-	-	-
Indirect Cost Rev-Federal Grants	-	-	-
<b>Total Revenues:</b>	<u>\$ -</u>	<u>\$ 3,500</u>	<u>\$ 11,382</u>
<b>Other Resources</b>			
Local HCTO Tax Collection Fees	-	-	-
State TRS Matching	-	-	-
Transfers In-Choice Partners	-	-	-
<b>Total Other Resources:</b>	<u>\$ -</u>	<u>\$ -</u>	<u>\$ -</u>
<b>Total Revenues &amp; Other Resources:</b>	<u>\$ -</u>	<u>\$ 3,500</u>	<u>\$ 11,382</u>
<b><u>EXPENDITURES &amp; OTHER USES</u></b>			
<b>Expenditures &amp; Encumbrances</b>			
Payroll Costs	-	-	-
Contracted & Professional Services	-	-	-
Supplies & Materials	-	-	-
Other Operating Costs	-	-	-
Debt Services	-	-	-
Capital Outlay	-	-	-
<b>Total Expenditures &amp; Encumbrances:</b>	<u>\$ -</u>	<u>\$ -</u>	<u>\$ -</u>
<b>Other Uses</b>			
Transfers Out-Special Revenue Funds	-	-	-
Transfers Out-Head Start Fund 205	-	-	-
Transfers Out-Head Start Fund 289	-	-	-
Transfers Out-Debt Service	-	-	-
Transfers Out-PFC Fund	-	-	-
Transfers Out-Department Wide	-	-	-
Transfers Out-COVID-19	-	-	-
Transfers Out-Star Reimagined	-	-	-
<b>Total Other Uses:</b>	<u>\$ -</u>	<u>\$ -</u>	<u>\$ -</u>
<b>Total Expenditures &amp; Other Uses:</b>	<u>\$ -</u>	<u>\$ -</u>	<u>\$ -</u>
<b>Revenue Over/(Under) Expenditures:</b>	<u>\$ -</u>	<u>\$ 3,500</u>	<u>\$ 11,382</u>

**HARRIS COUNTY DEPARTMENT OF EDUCATION**  
**INTERIM FINANCIAL REPORTS (Unaudited)**  
**GENERAL FUNDS DETAIL BY DIVISION**  
**ACTUALS AND ENCUMBRANCES-CURRENT YEAR V. PRIOR YEAR**  
 Fiscal year to date: June 30, 2021

**The Teaching and Learning Center-Science**

	CURRENT YEAR- BUDGET	CURRENT YEAR- ACTUAL REV, EXP AND ENC	PRIOR YEAR- ACTUAL REV, EXP & ENC
<b><u>REVENUES &amp; OTHER RESOURCES</u></b>			
<b>Revenues</b>			
Customer Fees/Charges	\$ 97,000	\$ 6,875	\$ 11,170
Local Property Tax Rev-Current	4,526	35,525	57,957
Local Property Tax Rev-Del, P&I	-	-	-
Investment Earnings	-	-	-
Insurance Recovery	-	-	-
FSP-Compensation	-	-	-
TEA-State Health Ins-Employee Portion	-	-	-
Local Grants	-	-	-
Other Local Revenues	-	-	-
Miscellaneous Revenues	-	-	-
Indirect Cost Rev-Local Grants	-	-	-
Indirect Cost Rev-State	-	-	-
Indirect Cost Rev-Federal Grants	-	-	-
<b>Total Revenues:</b>	<u>\$ 101,526</u>	<u>\$ 42,400</u>	<u>\$ 69,127</u>
<b>Other Resources</b>			
Local HCTO Tax Collection Fees	-	-	-
State TRS Matching	-	-	-
Transfers In-Choice Partners	-	-	-
<b>Total Other Resources:</b>	<u>\$ -</u>	<u>\$ -</u>	<u>\$ -</u>
<b>Total Revenues &amp; Other Resources:</b>	<u>\$ 101,526</u>	<u>\$ 42,400</u>	<u>\$ 69,127</u>
<b><u>EXPENDITURES &amp; OTHER USES</u></b>			
<b>Expenditures &amp; Encumbrances</b>			
Payroll Costs	70,586	36,696	56,858
Contracted & Professional Services	7,300	4,343	4,993
Supplies & Materials	11,800	802	3,209
Other Operating Costs	11,840	559	4,067
Debt Services	-	-	-
Capital Outlay	-	-	-
<b>Total Expenditures &amp; Encumbrances:</b>	<u>\$ 101,526</u>	<u>\$ 42,400</u>	<u>\$ 69,127</u>
<b>Other Uses</b>			
Transfers Out-Special Revenue Funds	-	-	-
Transfers Out-Head Start Fund 205	-	-	-
Transfers Out-Head Start Fund 289	-	-	-
Transfers Out-Debt Service	-	-	-
Transfers Out-PFC Fund	-	-	-
Transfers Out-Department Wide	-	-	-
Transfers Out-COVID-19	-	-	-
Transfers Out-Star Reimagined	-	-	-
<b>Total Other Uses:</b>	<u>\$ -</u>	<u>\$ -</u>	<u>\$ -</u>
<b>Total Expenditures &amp; Other Uses:</b>	<u>\$ 101,526</u>	<u>\$ 42,400</u>	<u>\$ 69,127</u>
<b>Revenue Over/(Under) Expenditures:</b>	<u>\$ -</u>	<u>\$ -</u>	<u>\$ -</u>

**HARRIS COUNTY DEPARTMENT OF EDUCATION**  
**INTERIM FINANCIAL REPORTS (Unaudited)**  
**GENERAL FUNDS DETAIL BY DIVISION**  
**ACTUALS AND ENCUMBRANCES-CURRENT YEAR V. PRIOR YEAR**  
Fiscal year to date: June 30, 2021

Schedule 12

**The Teaching and Learning Center-Social Studies**

	CURRENT YEAR- BUDGET	CURRENT YEAR- ACTUAL REV, EXP AND ENC	PRIOR YEAR- ACTUAL REV, EXP & ENC
<b><u>REVENUES &amp; OTHER RESOURCES</u></b>			
<b>Revenues</b>			
Customer Fees/Charges	\$ 22,000	\$ 1,400	\$ 2,300
Local Property Tax Rev-Current	31,522	27,229	26,709
Local Property Tax Rev-Del, P&I	-	-	-
Investment Earnings	-	-	-
Insurance Recovery	-	-	-
FSP-Compensation	-	-	-
TEA-State Health Ins-Employee Portion	-	-	-
Local Grants	-	-	-
Other Local Revenues	-	-	-
Miscellaneous Revenues	-	-	-
Indirect Cost Rev-Local Grants	-	-	-
Indirect Cost Rev-State	-	-	-
Indirect Cost Rev-Federal Grants	-	-	-
<b>Total Revenues:</b>	<u>\$ 53,522</u>	<u>\$ 28,629</u>	<u>\$ 29,009</u>
<b>Other Resources</b>			
Local HCTO Tax Collection Fees	-	-	-
State TRS Matching	-	-	-
Transfers In-Choice Partners	-	-	-
<b>Total Other Resources:</b>	<u>\$ -</u>	<u>\$ -</u>	<u>\$ -</u>
<b>Total Revenues &amp; Other Resources:</b>	<u>\$ 53,522</u>	<u>\$ 28,629</u>	<u>\$ 29,009</u>
<b><u>EXPENDITURES &amp; OTHER USES</u></b>			
<b>Expenditures &amp; Encumbrances</b>			
Payroll Costs	32,287	26,718	26,040
Contracted & Professional Services	6,500	1,585	2,355
Supplies & Materials	9,100	327	3,904
Other Operating Costs	5,635	-	220
Debt Services	-	-	-
Capital Outlay	-	-	-
<b>Total Expenditures &amp; Encumbrances:</b>	<u>\$ 53,522</u>	<u>\$ 28,629</u>	<u>\$ 32,519</u>
<b>Other Uses</b>			
Transfers Out-Special Revenue Funds	-	-	-
Transfers Out-Head Start Fund 205	-	-	-
Transfers Out-Head Start Fund 289	-	-	-
Transfers Out-Debt Service	-	-	-
Transfers Out-PFC Fund	-	-	-
Transfers Out-Department Wide	-	-	-
Transfers Out-COVID-19	-	-	-
Transfers Out-Star Reimagined	-	-	-
<b>Total Other Uses:</b>	<u>\$ -</u>	<u>\$ -</u>	<u>\$ -</u>
<b>Total Expenditures &amp; Other Uses:</b>	<u>\$ 53,522</u>	<u>\$ 28,629</u>	<u>\$ 32,519</u>
<b>Revenue Over/(Under) Expenditures:</b>	<u>\$ -</u>	<u>\$ -</u>	<u>\$(3,510)</u>

**HARRIS COUNTY DEPARTMENT OF EDUCATION**  
**INTERIM FINANCIAL REPORTS (Unaudited)**  
**GENERAL FUNDS DETAIL BY DIVISION**  
**ACTUALS AND ENCUMBRANCES-CURRENT YEAR V. PRIOR YEAR**  
Fiscal year to date: June 30, 2021

Schedule 12

**The Teaching and Learning Center-Speaker Series**

	CURRENT YEAR- BUDGET	CURRENT YEAR- ACTUAL REV, EXP AND ENC	PRIOR YEAR- ACTUAL REV, EXP & ENC
<b><u>REVENUES &amp; OTHER RESOURCES</u></b>			
<b>Revenues</b>			
Customer Fees/Charges	\$ 170,400	\$ 28,125	\$ 30,940
Local Property Tax Rev-Current	-	40,320	81,488
Local Property Tax Rev-Del, P&I	-	-	-
Investment Earnings	-	-	-
Insurance Recovery	-	-	-
FSP-Compensation	-	-	-
TEA-State Health Ins-Employee Portion	-	-	-
Local Grants	-	-	-
Other Local Revenues	-	-	-
Miscellaneous Revenues	-	-	-
Indirect Cost Rev-Local Grants	-	-	-
Indirect Cost Rev-State	-	-	-
Indirect Cost Rev-Federal Grants	-	-	-
<b>Total Revenues:</b>	<u>\$ 170,400</u>	<u>\$ 68,445</u>	<u>\$ 112,428</u>
<b>Other Resources</b>			
Local HCTO Tax Collection Fees	-	-	-
State TRS Matching	-	-	-
Transfers In-Choice Partners	-	-	-
<b>Total Other Resources:</b>	<u>\$ -</u>	<u>\$ -</u>	<u>\$ -</u>
<b>Total Revenues &amp; Other Resources:</b>	<u>\$ 170,400</u>	<u>\$ 68,445</u>	<u>\$ 112,428</u>
<b><u>EXPENDITURES &amp; OTHER USES</u></b>			
<b>Expenditures &amp; Encumbrances</b>			
Payroll Costs	44,176	33,471	40,234
Contracted & Professional Services	79,870	37,500	55,385
Supplies & Materials	16,900	9,387	11,551
Other Operating Costs	15,050	3,087	5,257
Debt Services	-	-	-
Capital Outlay	-	-	-
<b>Total Expenditures &amp; Encumbrances:</b>	<u>\$ 155,996</u>	<u>\$ 83,445</u>	<u>\$ 112,428</u>
<b>Other Uses</b>			
Transfers Out-Special Revenue Funds	-	-	-
Transfers Out-Head Start Fund 205	-	-	-
Transfers Out-Head Start Fund 289	-	-	-
Transfers Out-Debt Service	-	-	-
Transfers Out-PFC Fund	-	-	-
Transfers Out-Department Wide	-	-	-
Transfers Out-COVID-19	-	-	-
Transfers Out-Star Reimagined	-	-	-
<b>Total Other Uses:</b>	<u>\$ -</u>	<u>\$ -</u>	<u>\$ -</u>
<b>Total Expenditures &amp; Other Uses:</b>	<u>\$ 155,996</u>	<u>\$ 83,445</u>	<u>\$ 112,428</u>
<b>Revenue Over/(Under) Expenditures:</b>	<u>\$ 14,404</u>	<u>\$(15,000)</u>	<u>\$ -</u>

**HARRIS COUNTY DEPARTMENT OF EDUCATION**  
**INTERIM FINANCIAL REPORTS (Unaudited)**  
**GENERAL FUNDS DETAIL BY DIVISION**  
**ACTUALS AND ENCUMBRANCES-CURRENT YEAR V. PRIOR YEAR**  
 Fiscal year to date: June 30, 2021

**The Teaching and Learning Center-Special Education**

	CURRENT YEAR- BUDGET	CURRENT YEAR- ACTUAL REV, EXP AND ENC	PRIOR YEAR- ACTUAL REV, EXP & ENC
<b><u>REVENUES &amp; OTHER RESOURCES</u></b>			
<b>Revenues</b>			
Customer Fees/Charges	\$ 77,000	\$ 24,224	\$ 18,988
Local Property Tax Rev-Current	3,508	39,275	36,289
Local Property Tax Rev-Del, P&I	-	-	-
Investment Earnings	-	-	-
Insurance Recovery	-	-	-
FSP-Compensation	-	-	-
TEA-State Health Ins-Employee Portion	-	-	-
Local Grants	-	-	-
Other Local Revenues	-	-	-
Miscellaneous Revenues	-	-	-
Indirect Cost Rev-Local Grants	-	-	-
Indirect Cost Rev-State	-	-	-
Indirect Cost Rev-Federal Grants	-	-	-
<b>Total Revenues:</b>	<u>\$ 80,508</u>	<u>\$ 63,499</u>	<u>\$ 55,276</u>
<b>Other Resources</b>			
Local HCTO Tax Collection Fees	-	-	-
State TRS Matching	-	-	-
Transfers In-Choice Partners	-	-	-
<b>Total Other Resources:</b>	<u>\$ -</u>	<u>\$ -</u>	<u>\$ -</u>
<b>Total Revenues &amp; Other Resources:</b>	<u>\$ 80,508</u>	<u>\$ 63,499</u>	<u>\$ 55,276</u>
<b><u>EXPENDITURES &amp; OTHER USES</u></b>			
<b>Expenditures &amp; Encumbrances</b>			
Payroll Costs	67,952	56,267	54,444
Contracted & Professional Services	8,575	7,175	1,800
Supplies & Materials	1,277	22	638
Other Operating Costs	2,704	34	193
Debt Services	-	-	-
Capital Outlay	-	-	-
<b>Total Expenditures &amp; Encumbrances:</b>	<u>\$ 80,508</u>	<u>\$ 63,499</u>	<u>\$ 57,076</u>
<b>Other Uses</b>			
Transfers Out-Special Revenue Funds	-	-	-
Transfers Out-Head Start Fund 205	-	-	-
Transfers Out-Head Start Fund 289	-	-	-
Transfers Out-Debt Service	-	-	-
Transfers Out-PFC Fund	-	-	-
Transfers Out-Department Wide	-	-	-
Transfers Out-COVID-19	-	-	-
Transfers Out-Star Reimagined	-	-	-
<b>Total Other Uses:</b>	<u>\$ -</u>	<u>\$ -</u>	<u>\$ -</u>
<b>Total Expenditures &amp; Other Uses:</b>	<u>\$ 80,508</u>	<u>\$ 63,499</u>	<u>\$ 57,076</u>
<b>Revenue Over/(Under) Expenditures:</b>	<u>\$ -</u>	<u>\$ -</u>	<u>\$(1,800)</u>



**HARRIS COUNTY DEPARTMENT OF EDUCATION**  
**INTERIM FINANCIAL REPORTS (Unaudited)**  
**GENERAL FUNDS DETAIL BY DIVISION**  
**ACTUALS AND ENCUMBRANCES-CURRENT YEAR V. PRIOR YEAR**  
 Fiscal year to date: June 30, 2021

Schedule 12

**Purchasing Support Services**

	CURRENT YEAR- BUDGET	CURRENT YEAR- ACTUAL REV, EXP AND ENC	PRIOR YEAR- ACTUAL REV, EXP & ENC
<b>REVENUES &amp; OTHER RESOURCES</b>			
<b>Revenues</b>			
Customer Fees/Charges	\$ -	\$ -	\$ -
Local Property Tax Rev-Current	649,239	455,956	449,631
Local Property Tax Rev-Del, P&I	-	-	-
Investment Earnings	-	-	-
Insurance Recovery	-	-	-
FSP-Compensation	-	-	-
TEA-State Health Ins-Employee Portion	-	-	-
Local Grants	-	-	-
Other Local Revenues	-	-	-
Miscellaneous Revenues	-	-	-
Indirect Cost Rev-Local Grants	-	-	-
Indirect Cost Rev-State	-	-	-
Indirect Cost Rev-Federal Grants	-	-	-
<b>Total Revenues:</b>	<b>\$ 649,239</b>	<b>\$ 455,956</b>	<b>\$ 449,631</b>
<b>Other Resources</b>			
Local HCTO Tax Collection Fees	-	-	-
State TRS Matching	-	-	-
Transfers In-Choice Partners	-	-	-
<b>Total Other Resources:</b>	<b>\$ -</b>	<b>\$ -</b>	<b>\$ -</b>
<b>Total Revenues &amp; Other Resources:</b>	<b>\$ 649,239</b>	<b>\$ 455,956</b>	<b>\$ 449,631</b>
<b>EXPENDITURES &amp; OTHER USES</b>			
<b>Expenditures &amp; Encumbrances</b>			
Payroll Costs	523,669	396,330	425,590
Contracted & Professional Services	87,572	36,571	8,829
Supplies & Materials	24,200	4,575	6,077
Other Operating Costs	53,798	33,970	22,232
Debt Services	-	-	-
Capital Outlay	-	-	-
<b>Total Expenditures &amp; Encumbrances:</b>	<b>\$ 689,239</b>	<b>\$ 471,447</b>	<b>\$ 462,728</b>
<b>Other Uses</b>			
Transfers Out-Special Revenue Funds	-	-	-
Transfers Out-Head Start Fund 205	-	-	-
Transfers Out-Head Start Fund 289	-	-	-
Transfers Out-Debt Service	-	-	-
Transfers Out-PFC Fund	-	-	-
Transfers Out-Department Wide	-	-	-
Transfers Out-COVID-19	-	-	-
Transfers Out-Star Reimagined	-	-	-
<b>Total Other Uses:</b>	<b>\$ -</b>	<b>\$ -</b>	<b>\$ -</b>
<b>Total Expenditures &amp; Other Uses:</b>	<b>\$ 689,239</b>	<b>\$ 471,447</b>	<b>\$ 462,728</b>
<b>Revenue Over/(Under) Expenditures:</b>	<b>\$(40,000)</b>	<b>\$(15,491)</b>	<b>\$(13,097)</b>

**HARRIS COUNTY DEPARTMENT OF EDUCATION**  
**INTERIM FINANCIAL REPORTS (Unaudited)**  
**GENERAL FUNDS DETAIL BY DIVISION**  
**ACTUALS AND ENCUMBRANCES-CURRENT YEAR V. PRIOR YEAR**  
 Fiscal year to date: June 30, 2021

**QZAB & Maint Tax Notes FD**

	CURRENT YEAR- BUDGET	CURRENT YEAR- ACTUAL REV, EXP AND ENC	PRIOR YEAR- ACTUAL REV, EXP & ENC
<b>REVENUES &amp; OTHER RESOURCES</b>			
<b>Revenues</b>			
Customer Fees/Charges	\$ -	\$ -	\$ -
Local Property Tax Rev-Current	-	-	-
Local Property Tax Rev-Del, P&I	-	-	-
Investment Earnings	-	-	-
Insurance Recovery	-	-	-
FSP-Compensation	-	-	-
TEA-State Health Ins-Employee Portion	-	-	-
Local Grants	-	-	-
Other Local Revenues	-	-	-
Miscellaneous Revenues	-	-	-
Indirect Cost Rev-Local Grants	-	-	-
Indirect Cost Rev-State	-	-	-
Indirect Cost Rev-Federal Grants	-	-	-
<b>Total Revenues:</b>	<u>\$ -</u>	<u>\$ -</u>	<u>\$ -</u>
<b>Other Resources</b>			
Local HCTO Tax Collection Fees	-	-	-
State TRS Matching	-	-	-
Transfers In-Choice Partners	-	-	-
<b>Total Other Resources:</b>	<u>\$ -</u>	<u>\$ -</u>	<u>\$ -</u>
<b>Total Revenues &amp; Other Resources:</b>	<u>\$ -</u>	<u>\$ -</u>	<u>\$ -</u>
<b>EXPENDITURES &amp; OTHER USES</b>			
<b>Expenditures &amp; Encumbrances</b>			
Payroll Costs	-	-	-
Contracted & Professional Services	-	-	-
Supplies & Materials	-	-	-
Other Operating Costs	-	-	-
Debt Services	-	-	-
Capital Outlay	-	-	-
<b>Total Expenditures &amp; Encumbrances:</b>	<u>\$ -</u>	<u>\$ -</u>	<u>\$ -</u>
<b>Other Uses</b>			
Transfers Out-Special Revenue Funds	-	-	-
Transfers Out-Head Start Fund 205	-	-	-
Transfers Out-Head Start Fund 289	-	-	-
Transfers Out-Debt Service	-	-	-
Transfers Out-PFC Fund	-	-	-
Transfers Out-Department Wide	-	-	-
Transfers Out-COVID-19	-	-	-
Transfers Out-Star Reimagined	-	-	-
<b>Total Other Uses:</b>	<u>\$ -</u>	<u>\$ -</u>	<u>\$ -</u>
<b>Total Expenditures &amp; Other Uses:</b>	<u>\$ -</u>	<u>\$ -</u>	<u>\$ -</u>
<b>Revenue Over/(Under) Expenditures:</b>	<u>\$ -</u>	<u>\$ -</u>	<u>\$ -</u>

**HARRIS COUNTY DEPARTMENT OF EDUCATION**  
**INTERIM FINANCIAL REPORTS (Unaudited)**  
**GENERAL FUNDS DETAIL BY DIVISION**  
**ACTUALS AND ENCUMBRANCES-CURRENT YEAR V. PRIOR YEAR**  
Fiscal year to date: June 30, 2021

Schedule 12

**Research & Evaluation Institute**

	CURRENT YEAR- BUDGET	CURRENT YEAR- ACTUAL REV, EXP AND ENC	PRIOR YEAR- ACTUAL REV, EXP & ENC
<b><u>REVENUES &amp; OTHER RESOURCES</u></b>			
<b>Revenues</b>			
Customer Fees/Charges	\$ 149,500	\$ 111,036	\$ 39,750
Local Property Tax Rev-Current	501,427	373,577	465,128
Local Property Tax Rev-Del, P&I	-	-	-
Investment Earnings	-	-	-
Insurance Recovery	-	-	-
FSP-Compensation	-	-	-
TEA-State Health Ins-Employee Portion	-	-	-
Local Grants	-	-	-
Other Local Revenues	-	-	-
Miscellaneous Revenues	-	-	-
Indirect Cost Rev-Local Grants	-	-	-
Indirect Cost Rev-State	-	-	-
Indirect Cost Rev-Federal Grants	-	-	-
<b>Total Revenues:</b>	<u>\$ 650,927</u>	<u>\$ 484,613</u>	<u>\$ 504,878</u>
<b>Other Resources</b>			
Local HCTO Tax Collection Fees	-	-	-
State TRS Matching	-	-	-
Transfers In-Choice Partners	-	-	-
<b>Total Other Resources:</b>	<u>\$ -</u>	<u>\$ -</u>	<u>\$ -</u>
<b>Total Revenues &amp; Other Resources:</b>	<u>\$ 650,927</u>	<u>\$ 484,613</u>	<u>\$ 504,878</u>
<b><u>EXPENDITURES &amp; OTHER USES</u></b>			
<b>Expenditures &amp; Encumbrances</b>			
Payroll Costs	588,650	456,238	464,674
Contracted & Professional Services	3,374	-	242
Supplies & Materials	39,384	28,455	27,605
Other Operating Costs	19,519	8,905	16,998
Debt Services	-	-	-
Capital Outlay	-	-	-
<b>Total Expenditures &amp; Encumbrances:</b>	<u>\$ 650,927</u>	<u>\$ 493,599</u>	<u>\$ 509,520</u>
<b>Other Uses</b>			
Transfers Out-Special Revenue Funds	-	-	-
Transfers Out-Head Start Fund 205	-	-	-
Transfers Out-Head Start Fund 289	-	-	-
Transfers Out-Debt Service	-	-	-
Transfers Out-PFC Fund	-	-	-
Transfers Out-Department Wide	-	-	-
Transfers Out-COVID-19	-	-	-
Transfers Out-Star Reimagined	-	-	-
<b>Total Other Uses:</b>	<u>\$ -</u>	<u>\$ -</u>	<u>\$ -</u>
<b>Total Expenditures &amp; Other Uses:</b>	<u>\$ 650,927</u>	<u>\$ 493,599</u>	<u>\$ 509,520</u>
<b>Revenue Over/(Under) Expenditures:</b>	<u>\$ -</u>	<u>\$(8,986)</u>	<u>\$(4,642)</u>

**HARRIS COUNTY DEPARTMENT OF EDUCATION**  
**INTERIM FINANCIAL REPORTS (Unaudited)**  
**GENERAL FUNDS DETAIL BY DIVISION**  
**ACTUALS AND ENCUMBRANCES-CURRENT YEAR V. PRIOR YEAR**  
Fiscal year to date: June 30, 2021

Schedule 12

**Texas Center for Grants Development**

	CURRENT YEAR- BUDGET	CURRENT YEAR- ACTUAL REV, EXP AND ENC	PRIOR YEAR- ACTUAL REV, EXP & ENC
<b>REVENUES &amp; OTHER RESOURCES</b>			
<b>Revenues</b>			
Customer Fees/Charges	\$ 1,250	\$ 930	\$ 1,030
Local Property Tax Rev-Current	612,205	485,239	479,388
Local Property Tax Rev-Del, P&I	-	-	-
Investment Earnings	-	-	-
Insurance Recovery	-	-	-
FSP-Compensation	-	-	-
TEA-State Health Ins-Employee Portion	-	-	-
Local Grants	-	-	-
Other Local Revenues	-	-	-
Miscellaneous Revenues	-	-	-
Indirect Cost Rev-Local Grants	-	-	-
Indirect Cost Rev-State	-	-	-
Indirect Cost Rev-Federal Grants	-	-	-
<b>Total Revenues:</b>	<b>\$ 613,455</b>	<b>\$ 486,169</b>	<b>\$ 480,418</b>
<b>Other Resources</b>			
Local HCTO Tax Collection Fees	-	-	-
State TRS Matching	-	-	-
Transfers In-Choice Partners	-	-	-
<b>Total Other Resources:</b>	<b>\$ -</b>	<b>\$ -</b>	<b>\$ -</b>
<b>Total Revenues &amp; Other Resources:</b>	<b>\$ 613,455</b>	<b>\$ 486,169</b>	<b>\$ 480,418</b>
<b>EXPENDITURES &amp; OTHER USES</b>			
<b>Expenditures &amp; Encumbrances</b>			
Payroll Costs	555,958	459,332	447,218
Contracted & Professional Services	4,400	1,813	2,069
Supplies & Materials	22,921	13,991	15,813
Other Operating Costs	30,176	11,275	15,317
Debt Services	-	-	-
Capital Outlay	-	-	-
<b>Total Expenditures &amp; Encumbrances:</b>	<b>\$ 613,455</b>	<b>\$ 486,411</b>	<b>\$ 480,418</b>
<b>Other Uses</b>			
Transfers Out-Special Revenue Funds	-	-	-
Transfers Out-Head Start Fund 205	-	-	-
Transfers Out-Head Start Fund 289	-	-	-
Transfers Out-Debt Service	-	-	-
Transfers Out-PFC Fund	-	-	-
Transfers Out-Department Wide	-	-	-
Transfers Out-COVID-19	-	-	-
Transfers Out-Star Reimagined	-	-	-
<b>Total Other Uses:</b>	<b>\$ -</b>	<b>\$ -</b>	<b>\$ -</b>
<b>Total Expenditures &amp; Other Uses:</b>	<b>\$ 613,455</b>	<b>\$ 486,411</b>	<b>\$ 480,418</b>
<b>Revenue Over/(Under) Expenditures:</b>	<b>\$ -</b>	<b>\$(242)</b>	<b>\$ -</b>

**HARRIS COUNTY DEPARTMENT OF EDUCATION**  
**INTERIM FINANCIAL REPORTS (Unaudited)**  
**GENERAL FUNDS DETAIL BY DIVISION**  
**ACTUALS AND ENCUMBRANCES-CURRENT YEAR V. PRIOR YEAR**  
Fiscal year to date: June 30, 2021

**Retirement Leave Benefits Fund**

	CURRENT YEAR- BUDGET	CURRENT YEAR- ACTUAL REV, EXP AND ENC	PRIOR YEAR- ACTUAL REV, EXP & ENC
<b><u>REVENUES &amp; OTHER RESOURCES</u></b>			
<b>Revenues</b>			
Customer Fees/Charges	\$ -	\$ -	\$ -
Local Property Tax Rev-Current	150,000	333,844	231,057
Local Property Tax Rev-Del, P&I	-	-	-
Investment Earnings	-	-	-
Insurance Recovery	-	-	-
FSP-Compensation	-	-	-
TEA-State Health Ins-Employee Portion	-	-	-
Local Grants	-	-	-
Other Local Revenues	-	-	-
Miscellaneous Revenues	-	-	-
Indirect Cost Rev-Local Grants	-	-	-
Indirect Cost Rev-State	-	-	-
Indirect Cost Rev-Federal Grants	-	-	-
<b>Total Revenues:</b>	<u>\$ 150,000</u>	<u>\$ 333,844</u>	<u>\$ 231,057</u>
<b>Other Resources</b>			
Local HCTO Tax Collection Fees	-	-	-
State TRS Matching	-	-	-
Transfers In-Choice Partners	-	-	-
<b>Total Other Resources:</b>	<u>\$ -</u>	<u>\$ -</u>	<u>\$ -</u>
<b>Total Revenues &amp; Other Resources:</b>	<u>\$ 150,000</u>	<u>\$ 333,844</u>	<u>\$ 231,057</u>
<b><u>EXPENDITURES &amp; OTHER USES</u></b>			
<b>Expenditures &amp; Encumbrances</b>			
Payroll Costs	150,000	333,844	231,057
Contracted & Professional Services	-	-	-
Supplies & Materials	-	-	-
Other Operating Costs	-	-	-
Debt Services	-	-	-
Capital Outlay	-	-	-
<b>Total Expenditures &amp; Encumbrances:</b>	<u>\$ 150,000</u>	<u>\$ 333,844</u>	<u>\$ 231,057</u>
<b>Other Uses</b>			
Transfers Out-Special Revenue Funds	-	-	-
Transfers Out-Head Start Fund 205	-	-	-
Transfers Out-Head Start Fund 289	-	-	-
Transfers Out-Debt Service	-	-	-
Transfers Out-PFC Fund	-	-	-
Transfers Out-Department Wide	-	-	-
Transfers Out-COVID-19	-	-	-
Transfers Out-Star Reimagined	-	-	-
<b>Total Other Uses:</b>	<u>\$ -</u>	<u>\$ -</u>	<u>\$ -</u>
<b>Total Expenditures &amp; Other Uses:</b>	<u>\$ 150,000</u>	<u>\$ 333,844</u>	<u>\$ 231,057</u>
<b>Revenue Over/(Under) Expenditures:</b>	<u>\$ -</u>	<u>\$ -</u>	<u>\$ -</u>

**HARRIS COUNTY DEPARTMENT OF EDUCATION**  
**INTERIM FINANCIAL REPORTS (Unaudited)**  
**GENERAL FUNDS DETAIL BY DIVISION**  
**ACTUALS AND ENCUMBRANCES-CURRENT YEAR V. PRIOR YEAR**  
Fiscal year to date: June 30, 2021

<b>Scholastic Arts</b>
------------------------

	CURRENT YEAR- BUDGET	CURRENT YEAR- ACTUAL REV, EXP AND ENC	PRIOR YEAR- ACTUAL REV, EXP & ENC
<b><u>REVENUES &amp; OTHER RESOURCES</u></b>			
<b>Revenues</b>			
Customer Fees/Charges	\$ -	\$ 11,332	\$ 19,287
Local Property Tax Rev-Current	166,554	92,359	99,542
Local Property Tax Rev-Del, P&I	-	-	-
Investment Earnings	-	-	-
Insurance Recovery	-	-	-
FSP-Compensation	-	-	-
TEA-State Health Ins-Employee Portion	-	-	-
Local Grants	-	-	-
Other Local Revenues	-	5,000	5,000
Miscellaneous Revenues	-	-	-
Indirect Cost Rev-Local Grants	-	-	-
Indirect Cost Rev-State	-	-	-
Indirect Cost Rev-Federal Grants	-	-	-
<b>Total Revenues:</b>	\$ 166,554	\$ 108,691	\$ 123,828
<b>Other Resources</b>			
Local HCTO Tax Collection Fees	-	-	-
State TRS Matching	-	-	-
Transfers In-Choice Partners	-	-	-
<b>Total Other Resources:</b>	\$ -	\$ -	\$ -
<b>Total Revenues &amp; Other Resources:</b>	\$ 166,554	\$ 108,691	\$ 123,828
<b><u>EXPENDITURES &amp; OTHER USES</u></b>			
<b>Expenditures &amp; Encumbrances</b>			
Payroll Costs	110,540	78,515	93,463
Contracted & Professional Services	18,585	343	1,318
Supplies & Materials	2,610	8	8,669
Other Operating Costs	34,819	29,825	20,379
Debt Services	-	-	-
Capital Outlay	-	-	-
<b>Total Expenditures &amp; Encumbrances:</b>	\$ 166,554	\$ 108,691	\$ 123,828
<b>Other Uses</b>			
Transfers Out-Special Revenue Funds	-	-	-
Transfers Out-Head Start Fund 205	-	-	-
Transfers Out-Head Start Fund 289	-	-	-
Transfers Out-Debt Service	-	-	-
Transfers Out-PFC Fund	-	-	-
Transfers Out-Department Wide	-	-	-
Transfers Out-COVID-19	-	-	-
Transfers Out-Star Reimagined	-	-	-
<b>Total Other Uses:</b>	\$ -	\$ -	\$ -
<b>Total Expenditures &amp; Other Uses:</b>	\$ 166,554	\$ 108,691	\$ 123,828
<b>Revenue Over/(Under) Expenditures:</b>	\$ -	\$ -	\$ -

**HARRIS COUNTY DEPARTMENT OF EDUCATION**  
**INTERIM FINANCIAL REPORTS (Unaudited)**  
**GENERAL FUNDS DETAIL BY DIVISION**  
**ACTUALS AND ENCUMBRANCES-CURRENT YEAR V. PRIOR YEAR**  
 Fiscal year to date: June 30, 2021

Schedule 12

**Special Schools & Services-Academic and Behavior School East**

	CURRENT YEAR- BUDGET	CURRENT YEAR- ACTUAL REV, EXP AND ENC	PRIOR YEAR- ACTUAL REV, EXP & ENC
<b><u>REVENUES &amp; OTHER RESOURCES</u></b>			
<b>Revenues</b>			
Customer Fees/Charges	\$ 3,699,730	\$ 3,476,403	\$ 3,557,050
Local Property Tax Rev-Current	1,165,218	-	-
Local Property Tax Rev-Del, P&I	-	-	-
Investment Earnings	-	-	-
Insurance Recovery	-	-	-
FSP-Compensation	-	-	-
TEA-State Health Ins-Employee Portion	-	-	-
Local Grants	-	-	-
Other Local Revenues	-	-	-
Miscellaneous Revenues	-	-	-
Indirect Cost Rev-Local Grants	-	-	-
Indirect Cost Rev-State	-	-	-
Indirect Cost Rev-Federal Grants	-	-	-
<b>Total Revenues:</b>	<u>\$ 4,864,948</u>	<u>\$ 3,476,403</u>	<u>\$ 3,557,050</u>
<b>Other Resources</b>			
Local HCTO Tax Collection Fees	-	-	-
State TRS Matching	-	-	-
Transfers In-Choice Partners	-	-	-
<b>Total Other Resources:</b>	<u>\$ -</u>	<u>\$ -</u>	<u>\$ -</u>
<b>Total Revenues &amp; Other Resources:</b>	<u>\$ 4,864,948</u>	<u>\$ 3,476,403</u>	<u>\$ 3,557,050</u>
<b><u>EXPENDITURES &amp; OTHER USES</u></b>			
<b>Expenditures &amp; Encumbrances</b>			
Payroll Costs	4,200,012	2,688,973	2,640,174
Contracted & Professional Services	181,918	180,187	153,522
Supplies & Materials	119,967	103,635	129,804
Other Operating Costs	363,051	284,767	276,045
Debt Services	-	-	-
Capital Outlay	-	-	-
<b>Total Expenditures &amp; Encumbrances:</b>	<u>\$ 4,864,948</u>	<u>\$ 3,257,562</u>	<u>\$ 3,199,544</u>
<b>Other Uses</b>			
Transfers Out-Special Revenue Funds	-	-	-
Transfers Out-Head Start Fund 205	-	-	-
Transfers Out-Head Start Fund 289	-	-	-
Transfers Out-Debt Service	-	-	-
Transfers Out-PFC Fund	-	-	-
Transfers Out-Department Wide	-	-	-
Transfers Out-COVID-19	-	-	-
Transfers Out-Star Reimagined	-	-	-
<b>Total Other Uses:</b>	<u>\$ -</u>	<u>\$ -</u>	<u>\$ -</u>
<b>Total Expenditures &amp; Other Uses:</b>	<u>\$ 4,864,948</u>	<u>\$ 3,257,562</u>	<u>\$ 3,199,544</u>
<b>Revenue Over/(Under) Expenditures:</b>	<u>\$ -</u>	<u>\$ 218,840</u>	<u>\$ 357,506</u>

**HARRIS COUNTY DEPARTMENT OF EDUCATION**  
**INTERIM FINANCIAL REPORTS (Unaudited)**  
**GENERAL FUNDS DETAIL BY DIVISION**  
**ACTUALS AND ENCUMBRANCES-CURRENT YEAR V. PRIOR YEAR**  
Fiscal year to date: June 30, 2021

Schedule 12

**Special Schools & Services-Academic and Behavior School West**

	CURRENT YEAR- BUDGET	CURRENT YEAR- ACTUAL REV, EXP AND ENC	PRIOR YEAR- ACTUAL REV, EXP & ENC
<b><u>REVENUES &amp; OTHER RESOURCES</u></b>			
<b>Revenues</b>			
Customer Fees/Charges	\$ 3,222,318	\$ 2,407,066	\$ 2,714,675
Local Property Tax Rev-Current	1,437,097	768,404	141,677
Local Property Tax Rev-Del, P&I	-	-	-
Investment Earnings	-	-	-
Insurance Recovery	-	-	-
FSP-Compensation	-	-	-
TEA-State Health Ins-Employee Portion	-	-	-
Local Grants	-	-	-
Other Local Revenues	-	-	-
Miscellaneous Revenues	-	-	-
Indirect Cost Rev-Local Grants	-	-	-
Indirect Cost Rev-State	-	-	-
Indirect Cost Rev-Federal Grants	-	-	-
<b>Total Revenues:</b>	<u>\$ 4,659,415</u>	<u>\$ 3,175,469</u>	<u>\$ 2,856,352</u>
<b>Other Resources</b>			
Local HCTO Tax Collection Fees	-	-	-
State TRS Matching	-	-	-
Transfers In-Choice Partners	-	-	-
<b>Total Other Resources:</b>	<u>\$ -</u>	<u>\$ -</u>	<u>\$ -</u>
<b>Total Revenues &amp; Other Resources:</b>	<u>\$ 4,659,415</u>	<u>\$ 3,175,469</u>	<u>\$ 2,856,352</u>
<b><u>EXPENDITURES &amp; OTHER USES</u></b>			
<b>Expenditures &amp; Encumbrances</b>			
Payroll Costs	3,882,638	2,685,649	2,548,749
Contracted & Professional Services	116,358	103,429	84,877
Supplies & Materials	190,246	90,801	106,205
Other Operating Costs	464,173	333,005	169,176
Debt Services	-	-	-
Capital Outlay	6,000	5,683	-
<b>Total Expenditures &amp; Encumbrances:</b>	<u>\$ 4,659,415</u>	<u>\$ 3,218,567</u>	<u>\$ 2,909,007</u>
<b>Other Uses</b>			
Transfers Out-Special Revenue Funds	-	-	-
Transfers Out-Head Start Fund 205	-	-	-
Transfers Out-Head Start Fund 289	-	-	-
Transfers Out-Debt Service	-	-	-
Transfers Out-PFC Fund	-	-	-
Transfers Out-Department Wide	-	-	-
Transfers Out-COVID-19	-	-	-
Transfers Out-Star Reimagined	-	-	-
<b>Total Other Uses:</b>	<u>\$ -</u>	<u>\$ -</u>	<u>\$ -</u>
<b>Total Expenditures &amp; Other Uses:</b>	<u>\$ 4,659,415</u>	<u>\$ 3,218,567</u>	<u>\$ 2,909,007</u>
<b>Revenue Over/(Under) Expenditures:</b>	<u>\$ -</u>	<u>\$(43,098)</u>	<u>\$(52,655)</u>



**HARRIS COUNTY DEPARTMENT OF EDUCATION**  
**INTERIM FINANCIAL REPORTS (Unaudited)**  
**GENERAL FUNDS DETAIL BY DIVISION**  
**ACTUALS AND ENCUMBRANCES-CURRENT YEAR V. PRIOR YEAR**  
Fiscal year to date: June 30, 2021

Schedule 12

**Special Schools & Services-Fortis Academy**

	CURRENT YEAR- BUDGET	CURRENT YEAR- ACTUAL REV, EXP AND ENC	PRIOR YEAR- ACTUAL REV, EXP & ENC
<b><u>REVENUES &amp; OTHER RESOURCES</u></b>			
<b>Revenues</b>			
Customer Fees/Charges	\$ 256,250	\$ 181,250	\$ 275,000
Local Property Tax Rev-Current	1,151,149	689,010	124,228
Local Property Tax Rev-Del, P&I	-	-	-
Investment Earnings	-	-	-
Insurance Recovery	-	-	-
FSP-Compensation	-	-	-
TEA-State Health Ins-Employee Portion	-	-	-
Local Grants	-	-	-
Other Local Revenues	-	-	-
Miscellaneous Revenues	-	-	-
Indirect Cost Rev-Local Grants	-	-	-
Indirect Cost Rev-State	-	-	-
Indirect Cost Rev-Federal Grants	-	-	-
<b>Total Revenues:</b>	<u>\$ 1,407,399</u>	<u>\$ 870,260</u>	<u>\$ 399,228</u>
<b>Other Resources</b>			
Local HCTO Tax Collection Fees	-	-	-
State TRS Matching	-	-	-
Transfers In-Choice Partners	-	-	500,000
<b>Total Other Resources:</b>	<u>\$ -</u>	<u>\$ -</u>	<u>\$ 500,000</u>
<b>Total Revenues &amp; Other Resources:</b>	<u>\$ 1,407,399</u>	<u>\$ 870,260</u>	<u>\$ 899,228</u>
<b><u>EXPENDITURES &amp; OTHER USES</u></b>			
<b>Expenditures &amp; Encumbrances</b>			
Payroll Costs	799,493	622,937	641,476
Contracted & Professional Services	134,156	77,417	106,260
Supplies & Materials	249,098	71,756	93,241
Other Operating Costs	233,164	140,533	140,551
Debt Services	-	-	-
Capital Outlay	-	-	-
<b>Total Expenditures &amp; Encumbrances:</b>	<u>\$ 1,415,911</u>	<u>\$ 912,644</u>	<u>\$ 981,527</u>
<b>Other Uses</b>			
Transfers Out-Special Revenue Funds	-	-	-
Transfers Out-Head Start Fund 205	-	-	-
Transfers Out-Head Start Fund 289	-	-	-
Transfers Out-Debt Service	-	-	-
Transfers Out-PFC Fund	-	-	-
Transfers Out-Department Wide	-	-	-
Transfers Out-COVID-19	-	-	-
Transfers Out-Star Reimagined	-	-	-
<b>Total Other Uses:</b>	<u>\$ -</u>	<u>\$ -</u>	<u>\$ -</u>
<b>Total Expenditures &amp; Other Uses:</b>	<u>\$ 1,415,911</u>	<u>\$ 912,644</u>	<u>\$ 981,527</u>
<b>Revenue Over/(Under) Expenditures:</b>	<u>\$(8,512)</u>	<u>\$(42,384)</u>	<u>\$(82,299)</u>

**HARRIS COUNTY DEPARTMENT OF EDUCATION**  
**INTERIM FINANCIAL REPORTS (Unaudited)**  
**GENERAL FUNDS DETAIL BY DIVISION**  
**ACTUALS AND ENCUMBRANCES-CURRENT YEAR V. PRIOR YEAR**  
Fiscal year to date: June 30, 2021

Schedule 12

**Special Schools & Services-Highpoint East School**

	CURRENT YEAR- BUDGET	CURRENT YEAR- ACTUAL REV, EXP AND ENC	PRIOR YEAR- ACTUAL REV, EXP & ENC
<b><u>REVENUES &amp; OTHER RESOURCES</u></b>			
<b>Revenues</b>			
Customer Fees/Charges	\$ 2,012,977	\$ 1,536,682	\$ 2,169,808
Local Property Tax Rev-Current	1,389,469	1,099,504	399,139
Local Property Tax Rev-Del, P&I	-	-	-
Investment Earnings	-	-	-
Insurance Recovery	-	-	-
FSP-Compensation	-	-	-
TEA-State Health Ins-Employee Portion	-	-	-
Local Grants	-	-	-
Other Local Revenues	-	-	-
Miscellaneous Revenues	-	-	-
Indirect Cost Rev-Local Grants	-	-	-
Indirect Cost Rev-State	-	-	-
Indirect Cost Rev-Federal Grants	-	-	-
<b>Total Revenues:</b>	<u>\$ 3,402,446</u>	<u>\$ 2,636,186</u>	<u>\$ 2,568,947</u>
<b>Other Resources</b>			
Local HCTO Tax Collection Fees	-	-	-
State TRS Matching	-	-	-
Transfers In-Choice Partners	-	-	-
<b>Total Other Resources:</b>	<u>\$ -</u>	<u>\$ -</u>	<u>\$ -</u>
<b>Total Revenues &amp; Other Resources:</b>	<u>\$ 3,402,446</u>	<u>\$ 2,636,186</u>	<u>\$ 2,568,947</u>
<b><u>EXPENDITURES &amp; OTHER USES</u></b>			
<b>Expenditures &amp; Encumbrances</b>			
Payroll Costs	2,644,880	2,094,690	2,029,827
Contracted & Professional Services	231,920	217,549	218,447
Supplies & Materials	114,314	55,405	60,922
Other Operating Costs	411,332	301,674	305,148
Debt Services	-	-	-
Capital Outlay	-	-	-
<b>Total Expenditures &amp; Encumbrances:</b>	<u>\$ 3,402,446</u>	<u>\$ 2,669,318</u>	<u>\$ 2,614,344</u>
<b>Other Uses</b>			
Transfers Out-Special Revenue Funds	-	-	-
Transfers Out-Head Start Fund 205	-	-	-
Transfers Out-Head Start Fund 289	-	-	-
Transfers Out-Debt Service	-	-	-
Transfers Out-PFC Fund	-	-	-
Transfers Out-Department Wide	-	-	-
Transfers Out-COVID-19	-	-	-
Transfers Out-Star Reimagined	-	-	-
<b>Total Other Uses:</b>	<u>\$ -</u>	<u>\$ -</u>	<u>\$ -</u>
<b>Total Expenditures &amp; Other Uses:</b>	<u>\$ 3,402,446</u>	<u>\$ 2,669,318</u>	<u>\$ 2,614,344</u>
<b>Revenue Over/(Under) Expenditures:</b>	<u>\$ -</u>	<u>\$(33,132)</u>	<u>\$(45,397)</u>

**HARRIS COUNTY DEPARTMENT OF EDUCATION**  
**INTERIM FINANCIAL REPORTS (Unaudited)**  
**GENERAL FUNDS DETAIL BY DIVISION**  
**ACTUALS AND ENCUMBRANCES-CURRENT YEAR V. PRIOR YEAR**  
Fiscal year to date: June 30, 2021

Schedule 12

<b>Special Schools &amp; Services-Special Schools Administration</b>
--

	CURRENT YEAR- BUDGET	CURRENT YEAR- ACTUAL REV, EXP AND ENC	PRIOR YEAR- ACTUAL REV, EXP & ENC
<b><u>REVENUES &amp; OTHER RESOURCES</u></b>			
<b>Revenues</b>			
Customer Fees/Charges	\$ -	\$ -	\$ -
Local Property Tax Rev-Current	972,597	612,643	565,104
Local Property Tax Rev-Del, P&I	-	-	-
Investment Earnings	-	-	-
Insurance Recovery	-	-	-
FSP-Compensation	-	-	-
TEA-State Health Ins-Employee Portion	-	-	-
Local Grants	-	-	-
Other Local Revenues	-	11,552	12,379
Miscellaneous Revenues	-	-	-
Indirect Cost Rev-Local Grants	-	-	-
Indirect Cost Rev-State	-	-	-
Indirect Cost Rev-Federal Grants	-	-	-
<b>Total Revenues:</b>	<b>\$ 972,597</b>	<b>\$ 624,195</b>	<b>\$ 577,483</b>
<b>Other Resources</b>			
Local HCTO Tax Collection Fees	-	-	-
State TRS Matching	-	-	-
Transfers In-Choice Partners	-	-	-
<b>Total Other Resources:</b>	<b>\$ -</b>	<b>\$ -</b>	<b>\$ -</b>
<b>Total Revenues &amp; Other Resources:</b>	<b>\$ 972,597</b>	<b>\$ 624,195</b>	<b>\$ 577,483</b>
<b><u>EXPENDITURES &amp; OTHER USES</u></b>			
<b>Expenditures &amp; Encumbrances</b>			
Payroll Costs	481,864	418,496	383,247
Contracted & Professional Services	302,865	245,934	232,858
Supplies & Materials	140,672	37,297	24,971
Other Operating Costs	47,196	19,115	26,706
Debt Services	-	-	-
Capital Outlay	-	-	-
<b>Total Expenditures &amp; Encumbrances:</b>	<b>\$ 972,597</b>	<b>\$ 720,842</b>	<b>\$ 667,782</b>
<b>Other Uses</b>			
Transfers Out-Special Revenue Funds	-	-	-
Transfers Out-Head Start Fund 205	-	-	-
Transfers Out-Head Start Fund 289	-	-	-
Transfers Out-Debt Service	-	-	-
Transfers Out-PFC Fund	-	-	-
Transfers Out-Department Wide	-	-	-
Transfers Out-COVID-19	-	-	-
Transfers Out-Star Reimagined	-	-	-
<b>Total Other Uses:</b>	<b>\$ -</b>	<b>\$ -</b>	<b>\$ -</b>
<b>Total Expenditures &amp; Other Uses:</b>	<b>\$ 972,597</b>	<b>\$ 720,842</b>	<b>\$ 667,782</b>
<b>Revenue Over/(Under) Expenditures:</b>	<b>\$ -</b>	<b>\$(96,647)</b>	<b>\$(90,300)</b>

**HARRIS COUNTY DEPARTMENT OF EDUCATION**  
**INTERIM FINANCIAL REPORTS (Unaudited)**  
**GENERAL FUNDS DETAIL BY DIVISION**  
**ACTUALS AND ENCUMBRANCES-CURRENT YEAR V. PRIOR YEAR**  
Fiscal year to date: June 30, 2021

Schedule 12

**Superintendent's Office**

	CURRENT YEAR- BUDGET	CURRENT YEAR- ACTUAL REV, EXP AND ENC	PRIOR YEAR- ACTUAL REV, EXP & ENC
<b><u>REVENUES &amp; OTHER RESOURCES</u></b>			
<b>Revenues</b>			
Customer Fees/Charges	\$ -	\$ -	\$ -
Local Property Tax Rev-Current	669,457	524,334	458,968
Local Property Tax Rev-Del, P&I	-	-	-
Investment Earnings	-	-	-
Insurance Recovery	-	-	-
FSP-Compensation	-	-	-
TEA-State Health Ins-Employee Portion	-	-	-
Local Grants	-	-	-
Other Local Revenues	-	-	-
Miscellaneous Revenues	-	-	-
Indirect Cost Rev-Local Grants	-	-	-
Indirect Cost Rev-State	-	-	-
Indirect Cost Rev-Federal Grants	-	-	-
<b>Total Revenues:</b>	<u>\$ 669,457</u>	<u>\$ 524,334</u>	<u>\$ 458,968</u>
<b>Other Resources</b>			
Local HCTO Tax Collection Fees	-	-	-
State TRS Matching	-	-	-
Transfers In-Choice Partners	-	-	-
<b>Total Other Resources:</b>	<u>\$ -</u>	<u>\$ -</u>	<u>\$ -</u>
<b>Total Revenues &amp; Other Resources:</b>	<u>\$ 669,457</u>	<u>\$ 524,334</u>	<u>\$ 458,968</u>
<b><u>EXPENDITURES &amp; OTHER USES</u></b>			
<b>Expenditures &amp; Encumbrances</b>			
Payroll Costs	517,122	461,988	404,610
Contracted & Professional Services	87,257	43,013	25,633
Supplies & Materials	12,770	3,974	8,337
Other Operating Costs	52,308	15,359	20,594
Debt Services	-	-	-
Capital Outlay	-	-	-
<b>Total Expenditures &amp; Encumbrances:</b>	<u>\$ 669,457</u>	<u>\$ 524,334</u>	<u>\$ 459,173</u>
<b>Other Uses</b>			
Transfers Out-Special Revenue Funds	-	-	-
Transfers Out-Head Start Fund 205	-	-	-
Transfers Out-Head Start Fund 289	-	-	-
Transfers Out-Debt Service	-	-	-
Transfers Out-PFC Fund	-	-	-
Transfers Out-Department Wide	-	-	-
Transfers Out-COVID-19	-	-	-
Transfers Out-Star Reimagined	-	-	-
<b>Total Other Uses:</b>	<u>\$ -</u>	<u>\$ -</u>	<u>\$ -</u>
<b>Total Expenditures &amp; Other Uses:</b>	<u>\$ 669,457</u>	<u>\$ 524,334</u>	<u>\$ 459,173</u>
<b>Revenue Over/(Under) Expenditures:</b>	<u>\$ -</u>	<u>\$ -</u>	<u>\$(205)</u>

**HARRIS COUNTY DEPARTMENT OF EDUCATION**  
**INTERIM FINANCIAL REPORTS (Unaudited)**  
**GENERAL FUNDS DETAIL BY DIVISION**  
**ACTUALS AND ENCUMBRANCES-CURRENT YEAR V. PRIOR YEAR**  
Fiscal year to date: June 30, 2021

**State TEA Employee Portion Health Ins**

	CURRENT YEAR- BUDGET	CURRENT YEAR- ACTUAL REV, EXP AND ENC	PRIOR YEAR- ACTUAL REV, EXP & ENC
<b><u>REVENUES &amp; OTHER RESOURCES</u></b>			
<b>Revenues</b>			
Customer Fees/Charges	\$ -	\$ -	\$ -
Local Property Tax Rev-Current	-	-	-
Local Property Tax Rev-Del, P&I	-	-	-
Investment Earnings	-	-	-
Insurance Recovery	-	-	-
FSP-Compensation	-	-	-
TEA-State Health Ins-Employee Portion	-	319,462	332,069
Local Grants	-	-	-
Other Local Revenues	-	-	-
Miscellaneous Revenues	-	-	-
Indirect Cost Rev-Local Grants	-	-	-
Indirect Cost Rev-State	-	-	-
Indirect Cost Rev-Federal Grants	-	-	-
<b>Total Revenues:</b>	<b>\$ -</b>	<b>\$ 319,462</b>	<b>\$ 332,069</b>
<b>Other Resources</b>			
Local HCTO Tax Collection Fees	-	-	-
State TRS Matching	-	-	-
Transfers In-Choice Partners	-	-	-
<b>Total Other Resources:</b>	<b>\$ -</b>	<b>\$ -</b>	<b>\$ -</b>
<b>Total Revenues &amp; Other Resources:</b>	<b>\$ -</b>	<b>\$ 319,462</b>	<b>\$ 332,069</b>
<b><u>EXPENDITURES &amp; OTHER USES</u></b>			
<b>Expenditures &amp; Encumbrances</b>			
Payroll Costs	-	-	-
Contracted & Professional Services	-	-	-
Supplies & Materials	-	-	-
Other Operating Costs	-	-	-
Debt Services	-	-	-
Capital Outlay	-	-	-
<b>Total Expenditures &amp; Encumbrances:</b>	<b>\$ -</b>	<b>\$ -</b>	<b>\$ -</b>
<b>Other Uses</b>			
Transfers Out-Special Revenue Funds	-	-	-
Transfers Out-Head Start Fund 205	-	-	-
Transfers Out-Head Start Fund 289	-	-	-
Transfers Out-Debt Service	-	-	-
Transfers Out-PFC Fund	-	-	-
Transfers Out-Department Wide	-	-	-
Transfers Out-COVID-19	-	-	-
Transfers Out-Star Reimagined	-	-	-
<b>Total Other Uses:</b>	<b>\$ -</b>	<b>\$ -</b>	<b>\$ -</b>
<b>Total Expenditures &amp; Other Uses:</b>	<b>\$ -</b>	<b>\$ -</b>	<b>\$ -</b>
<b>Revenue Over/(Under) Expenditures:</b>	<b>\$ -</b>	<b>\$ 319,462</b>	<b>\$ 332,069</b>

**HARRIS COUNTY DEPARTMENT OF EDUCATION**  
**INTERIM FINANCIAL REPORTS (Unaudited)**  
**GENERAL FUNDS DETAIL BY DIVISION**  
**ACTUALS AND ENCUMBRANCES-CURRENT YEAR V. PRIOR YEAR**  
Fiscal year to date: June 30, 2021

**State TRS On Behalf Payments**

	CURRENT YEAR- BUDGET	CURRENT YEAR- ACTUAL REV, EXP AND ENC	PRIOR YEAR- ACTUAL REV, EXP & ENC
<b><u>REVENUES &amp; OTHER RESOURCES</u></b>			
<b>Revenues</b>			
Customer Fees/Charges	\$ -	\$ -	\$ -
Local Property Tax Rev-Current	-	-	-
Local Property Tax Rev-Del, P&I	-	-	-
Investment Earnings	-	-	-
Insurance Recovery	-	-	-
FSP-Compensation	-	-	-
TEA-State Health Ins-Employee Portion	-	-	-
Local Grants	-	-	-
Other Local Revenues	-	-	-
Miscellaneous Revenues	-	-	-
Indirect Cost Rev-Local Grants	-	-	-
Indirect Cost Rev-State	-	-	-
Indirect Cost Rev-Federal Grants	-	-	-
<b>Total Revenues:</b>	<u>\$ -</u>	<u>\$ -</u>	<u>\$ -</u>
<b>Other Resources</b>			
Local HCTO Tax Collection Fees	-	-	-
State TRS Matching	3,000,000	-	-
Transfers In-Choice Partners	-	-	-
<b>Total Other Resources:</b>	<u>\$ 3,000,000</u>	<u>\$ -</u>	<u>\$ -</u>
<b>Total Revenues &amp; Other Resources:</b>	<u>\$ 3,000,000</u>	<u>\$ -</u>	<u>\$ -</u>
<b><u>EXPENDITURES &amp; OTHER USES</u></b>			
<b>Expenditures &amp; Encumbrances</b>			
Payroll Costs	3,000,000	-	-
Contracted & Professional Services	-	-	-
Supplies & Materials	-	-	-
Other Operating Costs	-	-	-
Debt Services	-	-	-
Capital Outlay	-	-	-
<b>Total Expenditures &amp; Encumbrances:</b>	<u>\$ 3,000,000</u>	<u>\$ -</u>	<u>\$ -</u>
<b>Other Uses</b>			
Transfers Out-Special Revenue Funds	-	-	-
Transfers Out-Head Start Fund 205	-	-	-
Transfers Out-Head Start Fund 289	-	-	-
Transfers Out-Debt Service	-	-	-
Transfers Out-PFC Fund	-	-	-
Transfers Out-Department Wide	-	-	-
Transfers Out-COVID-19	-	-	-
Transfers Out-Star Reimagined	-	-	-
<b>Total Other Uses:</b>	<u>\$ -</u>	<u>\$ -</u>	<u>\$ -</u>
<b>Total Expenditures &amp; Other Uses:</b>	<u>\$ 3,000,000</u>	<u>\$ -</u>	<u>\$ -</u>
<b>Revenue Over/(Under) Expenditures:</b>	<u>\$ -</u>	<u>\$ -</u>	<u>\$ -</u>

**HARRIS COUNTY DEPARTMENT OF EDUCATION**  
**INTERIM FINANCIAL REPORTS (Unaudited)**  
**GENERAL FUNDS DETAIL BY DIVISION**  
**ACTUALS AND ENCUMBRANCES-CURRENT YEAR V. PRIOR YEAR**  
Fiscal year to date: June 30, 2021

<b>Technology-Chief Communications Officer</b>
--

	CURRENT YEAR- BUDGET	CURRENT YEAR- ACTUAL REV, EXP AND ENC	PRIOR YEAR- ACTUAL REV, EXP & ENC
<b><u>REVENUES &amp; OTHER RESOURCES</u></b>			
<b>Revenues</b>			
Customer Fees/Charges	\$ -	\$ -	\$ -
Local Property Tax Rev-Current	204,755	156,380	155,875
Local Property Tax Rev-Del, P&I	-	-	-
Investment Earnings	-	-	-
Insurance Recovery	-	-	-
FSP-Compensation	-	-	-
TEA-State Health Ins-Employee Portion	-	-	-
Local Grants	-	-	-
Other Local Revenues	-	-	-
Miscellaneous Revenues	-	-	-
Indirect Cost Rev-Local Grants	-	-	-
Indirect Cost Rev-State	-	-	-
Indirect Cost Rev-Federal Grants	-	-	-
<b>Total Revenues:</b>	\$ 204,755	\$ 156,380	\$ 155,875
<b>Other Resources</b>			
Local HCTO Tax Collection Fees	-	-	-
State TRS Matching	-	-	-
Transfers In-Choice Partners	-	-	-
<b>Total Other Resources:</b>	\$ -	\$ -	\$ -
<b>Total Revenues &amp; Other Resources:</b>	\$ 204,755	\$ 156,380	\$ 155,875
<b><u>EXPENDITURES &amp; OTHER USES</u></b>			
<b>Expenditures &amp; Encumbrances</b>			
Payroll Costs	183,481	152,463	148,463
Contracted & Professional Services	1,500	343	343
Supplies & Materials	5,850	298	290
Other Operating Costs	13,924	3,276	6,779
Debt Services	-	-	-
Capital Outlay	-	-	-
<b>Total Expenditures &amp; Encumbrances:</b>	\$ 204,755	\$ 156,380	\$ 155,875
<b>Other Uses</b>			
Transfers Out-Special Revenue Funds	-	-	-
Transfers Out-Head Start Fund 205	-	-	-
Transfers Out-Head Start Fund 289	-	-	-
Transfers Out-Debt Service	-	-	-
Transfers Out-PFC Fund	-	-	-
Transfers Out-Department Wide	-	-	-
Transfers Out-COVID-19	-	-	-
Transfers Out-Star Reimagined	-	-	-
<b>Total Other Uses:</b>	\$ -	\$ -	\$ -
<b>Total Expenditures &amp; Other Uses:</b>	\$ 204,755	\$ 156,380	\$ 155,875
<b>Revenue Over/(Under) Expenditures:</b>	\$ -	\$ -	\$ -

**HARRIS COUNTY DEPARTMENT OF EDUCATION**  
**INTERIM FINANCIAL REPORTS (Unaudited)**  
**GENERAL FUNDS DETAIL BY DIVISION**  
**ACTUALS AND ENCUMBRANCES-CURRENT YEAR V. PRIOR YEAR**  
Fiscal year to date: June 30, 2021

Schedule 12

**Technology-Technology Support Services**

	CURRENT YEAR- BUDGET	CURRENT YEAR- ACTUAL REV, EXP AND ENC	PRIOR YEAR- ACTUAL REV, EXP & ENC
<b><u>REVENUES &amp; OTHER RESOURCES</u></b>			
<b>Revenues</b>			
Customer Fees/Charges	\$ 3,003	\$ -	\$ -
Local Property Tax Rev-Current	2,791,350	2,258,866	1,973,714
Local Property Tax Rev-Del, P&I	-	-	-
Investment Earnings	-	-	-
Insurance Recovery	-	-	-
FSP-Compensation	-	-	-
TEA-State Health Ins-Employee Portion	-	-	-
Local Grants	-	-	-
Other Local Revenues	-	-	-
Miscellaneous Revenues	-	-	-
Indirect Cost Rev-Local Grants	-	-	-
Indirect Cost Rev-State	-	-	-
Indirect Cost Rev-Federal Grants	1,356,791	713,325	669,526
<b>Total Revenues:</b>	<u>\$ 4,151,144</u>	<u>\$ 2,972,191</u>	<u>\$ 2,643,239</u>
<b>Other Resources</b>			
Local HCTO Tax Collection Fees	-	-	-
State TRS Matching	-	-	-
Transfers In-Choice Partners	-	-	-
<b>Total Other Resources:</b>	<u>\$ -</u>	<u>\$ -</u>	<u>\$ -</u>
<b>Total Revenues &amp; Other Resources:</b>	<u>\$ 4,151,144</u>	<u>\$ 2,972,191</u>	<u>\$ 2,643,239</u>
<b><u>EXPENDITURES &amp; OTHER USES</u></b>			
<b>Expenditures &amp; Encumbrances</b>			
Payroll Costs	2,333,990	1,838,432	1,660,847
Contracted & Professional Services	589,846	470,618	437,386
Supplies & Materials	913,636	798,249	640,486
Other Operating Costs	120,984	66,241	109,004
Debt Services	-	-	-
Capital Outlay	-	-	43,106
<b>Total Expenditures &amp; Encumbrances:</b>	<u>\$ 3,958,456</u>	<u>\$ 3,173,540</u>	<u>\$ 2,890,829</u>
<b>Other Uses</b>			
Transfers Out-Special Revenue Funds	-	-	-
Transfers Out-Head Start Fund 205	-	-	-
Transfers Out-Head Start Fund 289	-	-	-
Transfers Out-Debt Service	-	-	-
Transfers Out-PFC Fund	-	-	-
Transfers Out-Department Wide	-	-	-
Transfers Out-COVID-19	-	-	-
Transfers Out-Star Reimagined	-	-	-
<b>Total Other Uses:</b>	<u>\$ -</u>	<u>\$ -</u>	<u>\$ -</u>
<b>Total Expenditures &amp; Other Uses:</b>	<u>\$ 3,958,456</u>	<u>\$ 3,173,540</u>	<u>\$ 2,890,829</u>
<b>Revenue Over/(Under) Expenditures:</b>	<u>\$ 192,688</u>	<u>\$(201,349)</u>	<u>\$(247,590)</u>



**HARRIS COUNTY DEPARTMENT OF EDUCATION**  
**INTERIM FINANCIAL REPORTS (Unaudited)**  
**GENERAL FUNDS DETAIL BY DIVISION**  
**ACTUALS AND ENCUMBRANCES-CURRENT YEAR V. PRIOR YEAR**  
Fiscal year to date: June 30, 2021

Schedule 12

**School Based Therapy Services**

	CURRENT YEAR- BUDGET	CURRENT YEAR- ACTUAL REV, EXP AND ENC	PRIOR YEAR- ACTUAL REV, EXP & ENC
<b><u>REVENUES &amp; OTHER RESOURCES</u></b>			
<b>Revenues</b>			
Customer Fees/Charges	\$ 10,170,332	\$ 8,486,558	\$ 8,856,978
Local Property Tax Rev-Current	2,563,322	1,108,993	585,843
Local Property Tax Rev-Del, P&I	-	-	-
Investment Earnings	-	-	-
Insurance Recovery	-	-	-
FSP-Compensation	-	-	-
TEA-State Health Ins-Employee Portion	-	-	-
Local Grants	-	-	-
Other Local Revenues	-	-	-
Miscellaneous Revenues	-	-	-
Indirect Cost Rev-Local Grants	-	-	-
Indirect Cost Rev-State	-	-	-
Indirect Cost Rev-Federal Grants	-	-	-
<b>Total Revenues:</b>	<u>\$ 12,733,654</u>	<u>\$ 9,595,551</u>	<u>\$ 9,442,821</u>
<b>Other Resources</b>			
Local HCTO Tax Collection Fees	-	-	-
State TRS Matching	-	-	-
Transfers In-Choice Partners	-	-	-
<b>Total Other Resources:</b>	<u>\$ -</u>	<u>\$ -</u>	<u>\$ -</u>
<b>Total Revenues &amp; Other Resources:</b>	<u>\$ 12,733,654</u>	<u>\$ 9,595,551</u>	<u>\$ 9,442,821</u>
<b><u>EXPENDITURES &amp; OTHER USES</u></b>			
<b>Expenditures &amp; Encumbrances</b>			
Payroll Costs	12,324,427	9,449,701	9,246,071
Contracted & Professional Services	44,900	20,060	24,827
Supplies & Materials	125,900	95,449	48,801
Other Operating Costs	238,427	115,105	127,372
Debt Services	-	-	-
Capital Outlay	-	-	-
<b>Total Expenditures &amp; Encumbrances:</b>	<u>\$ 12,733,654</u>	<u>\$ 9,680,315</u>	<u>\$ 9,447,071</u>
<b>Other Uses</b>			
Transfers Out-Special Revenue Funds	-	-	-
Transfers Out-Head Start Fund 205	-	-	-
Transfers Out-Head Start Fund 289	-	-	-
Transfers Out-Debt Service	-	-	-
Transfers Out-PFC Fund	-	-	-
Transfers Out-Department Wide	-	-	-
Transfers Out-COVID-19	-	-	-
Transfers Out-Star Reimagined	-	-	-
<b>Total Other Uses:</b>	<u>\$ -</u>	<u>\$ -</u>	<u>\$ -</u>
<b>Total Expenditures &amp; Other Uses:</b>	<u>\$ 12,733,654</u>	<u>\$ 9,680,315</u>	<u>\$ 9,447,071</u>
<b>Revenue Over/(Under) Expenditures:</b>	<u>\$ -</u>	<u>\$(84,764)</u>	<u>\$(4,251)</u>

**HARRIS COUNTY DEPARTMENT OF EDUCATION**  
**INTERIM FINANCIAL REPORTS (Unaudited)**  
**GENERAL FUNDS DETAIL BY DIVISION**  
**ACTUALS AND ENCUMBRANCES-CURRENT YEAR V. PRIOR YEAR**  
 Fiscal year to date: June 30, 2021

Schedule 12

<b>Total General Fund</b>			
	CURRENT YEAR- BUDGET	CURRENT YEAR- ACTUAL REV, EXP AND ENC	PRIOR YEAR- ACTUAL REV, EXP & ENC
<b><u>REVENUES &amp; OTHER RESOURCES</u></b>			
<b>Revenues</b>			
Customer Fees/Charges	\$ 23,493,005	\$ 18,360,387	\$ 20,286,882
Local Property Tax Rev-Current	25,038,000	24,806,413	23,498,000
Local Property Tax Rev-Del, P&I	288,432	195,186	69,769
Investment Earnings	170,000	16,030	358,033
Insurance Recovery	512,211	302,570	-
FSP-Compensation	-	157,347	163,556
TEA-State Health Ins-Employee Portion	-	319,462	332,069
Local Grants	-	-	-
Other Local Revenues	90,000	75,853	136,879
Miscellaneous Revenues	-	21,687	1,756
Indirect Cost Rev-Local Grants	727	4,010	-
Indirect Cost Rev-State	-	-	-
Indirect Cost Rev-Federal Grants	2,597,787	1,505,226	1,414,101
<b>Total Revenues:</b>	<u>\$ 52,190,162</u>	<u>\$ 45,764,171</u>	<u>\$ 46,261,046</u>
<b>Other Resources</b>			
Local HCTO Tax Collection Fees	-	-	-
State TRS Matching	3,000,000	-	-
Transfers In-Choice Partners	2,927,240	4,152,381	2,782,766
<b>Total Other Resources:</b>	<u>\$ 5,927,240</u>	<u>\$ 4,152,381</u>	<u>\$ 2,782,766</u>
<b>Total Revenues &amp; Other Resources:</b>	<u>\$ 58,117,402</u>	<u>\$ 49,916,552</u>	<u>\$ 49,043,813</u>
<b><u>EXPENDITURES &amp; OTHER USES</u></b>			
<b>Expenditures &amp; Encumbrances</b>			
Payroll Costs	38,961,777	28,192,219	27,481,782
Contracted & Professional Services	5,768,046	4,325,253	4,347,728
Supplies & Materials	3,046,435	1,735,311	2,213,297
Other Operating Costs	8,244,426	5,742,081	4,883,536
Debt Services	-	-	-
Capital Outlay	226,092	69,802	271,727
<b>Total Expenditures &amp; Encumbrances:</b>	<u>\$ 56,246,776</u>	<u>\$ 40,064,666</u>	<u>\$ 39,198,069</u>
<b>Other Uses</b>			
Transfers Out-Special Revenue Funds	550,787	-	-
Transfers Out-Head Start Fund 205	450,000	72,983	126,227
Transfers Out-Head Start La Porte	526,705	-	-
Transfers Out-Debt Service	6,469,042	3,164,984	2,824,030
Transfers Out-PFC Fund	-	-	-
Transfers Out-Department Wide	5,440,000	-	1,573,912
Transfers Out-COVID-19	-	-	135,796
Transfers Out-Star Reimagined	542,764	350,654	-
<b>Total Other Uses:</b>	<u>\$ 13,933,708</u>	<u>\$ 3,588,621</u>	<u>\$ 4,659,965</u>
<b>Total Expenditures &amp; Other Uses:</b>	<u>\$ 70,240,484</u>	<u>\$ 43,653,288</u>	<u>\$ 43,858,034</u>
<b>Revenue Over/(Under) Expenditures:</b>	<u>\$ (12,123,082)</u>	<u>\$ 6,263,264</u>	<u>\$ 5,185,779</u>

**HARRIS COUNTY DEPARTMENT OF EDUCATION**  
**INTERIM FINANCIAL REPORTS (Unaudited)**  
**SPECIAL REVENUE FUNDS DETAIL BY DIVISION**  
**ACTUALS AND ENCUMBRANCES-CURRENT YEAR V. PRIOR YEAR**  
 Fiscal year to date: June 30, 2021

<b>Adult Education Program</b>			
	CURRENT YEAR- BUDGET	CURRENT YEAR- ACTUAL REV, EXP AND ENC	PRIOR YEAR- ACTUAL REV, EXP & ENC
<b><u>REVENUES &amp; OTHER RESOURCES</u></b>			
<b>Revenues</b>			
Local Revenues	\$ 1,108	\$ -	\$ -
State Program Revenue	-	-	-
Federal Program Revenue	4,090,689	2,311,037	2,976,140
<b>Total Revenues:</b>	<u>\$ 4,091,797</u>	<u>\$ 2,311,037</u>	<u>\$ 2,976,140</u>
<b>Other Resources</b>			
Transfers In	49,660	49,522	-
<b>Total Other Resources:</b>	<u>\$ 49,660</u>	<u>\$ 49,522</u>	<u>\$ -</u>
<b>Total Revenues &amp; Other Resources:</b>	<u>\$ 4,141,457</u>	<u>\$ 2,360,559</u>	<u>\$ 2,976,140</u>
<b><u>EXPENDITURES &amp; OTHER USES</u></b>			
<b>Expenditures &amp; Encumbrances</b>			
Payroll Costs	2,775,529	2,271,878	2,808,342
Contracted & Professional Services	615,403	472,897	240,778
Supplies & Materials	638,301	524,520	594,144
Other Operating Costs	112,224	16,008	30,479
Capital Outlay	-	-	-
<b>Total Expenditures &amp; Encumbrances:</b>	<u>\$ 4,141,457</u>	<u>\$ 3,285,302</u>	<u>\$ 3,673,742</u>
<b>Other Uses</b>			
Transfers Out	-	-	-
<b>Total Other Uses:</b>	<u>\$ -</u>	<u>\$ -</u>	<u>\$ -</u>
<b>Total Expenditures &amp; Other Uses:</b>	<u>\$ 4,141,457</u>	<u>\$ 3,285,302</u>	<u>\$ 3,673,742</u>
<b>Revenue Over/(Under) Expenditures:</b>	<u>\$ -</u>	<u>\$(924,743)</u>	<u>\$(697,603)</u>

**HARRIS COUNTY DEPARTMENT OF EDUCATION**  
**INTERIM FINANCIAL REPORTS (Unaudited)**  
**SPECIAL REVENUE FUNDS DETAIL BY DIVISION**  
**ACTUALS AND ENCUMBRANCES-CURRENT YEAR V. PRIOR YEAR**  
 Fiscal year to date: June 30, 2021

<b>Educator Certification &amp; Advancement</b>			
	CURRENT YEAR- BUDGET	CURRENT YEAR- ACTUAL REV, EXP AND ENC	PRIOR YEAR- ACTUAL REV, EXP & ENC
<b><u>REVENUES &amp; OTHER RESOURCES</u></b>			
<b>Revenues</b>			
Local Revenues	\$ -	\$ -	\$ -
State Program Revenue	-	-	-
Federal Program Revenue	20,000	6,000	9,500
<b>Total Revenues:</b>	<u>\$ 20,000</u>	<u>\$ 6,000</u>	<u>\$ 9,500</u>
<b>Other Resources</b>			
Transfers In	-	-	-
<b>Total Other Resources:</b>	<u>\$ -</u>	<u>\$ -</u>	<u>\$ -</u>
<b>Total Revenues &amp; Other Resources:</b>	<u>\$ 20,000</u>	<u>\$ 6,000</u>	<u>\$ 9,500</u>
<b><u>EXPENDITURES &amp; OTHER USES</u></b>			
<b>Expenditures &amp; Encumbrances</b>			
Payroll Costs	-	-	161
Contracted & Professional Services	-	-	-
Supplies & Materials	-	-	-
Other Operating Costs	20,000	6,500	9,500
Capital Outlay	-	-	-
<b>Total Expenditures &amp; Encumbrances:</b>	<u>\$ 20,000</u>	<u>\$ 6,500</u>	<u>\$ 9,661</u>
<b>Other Uses</b>			
Transfers Out	-	-	-
<b>Total Other Uses:</b>	<u>\$ -</u>	<u>\$ -</u>	<u>\$ -</u>
<b>Total Expenditures &amp; Other Uses:</b>	<u>\$ 20,000</u>	<u>\$ 6,500</u>	<u>\$ 9,661</u>
<b>Revenue Over/(Under) Expenditures:</b>	<u>\$ -</u>	<u>\$(500)</u>	<u>\$(161)</u>

**HARRIS COUNTY DEPARTMENT OF EDUCATION**  
**INTERIM FINANCIAL REPORTS (Unaudited)**  
**SPECIAL REVENUE FUNDS DETAIL BY DIVISION**  
**ACTUALS AND ENCUMBRANCES-CURRENT YEAR V. PRIOR YEAR**  
 Fiscal year to date: June 30, 2021

<b>Ctr A/S Summ &amp; Exp Learn</b>			
	CURRENT YEAR- BUDGET	CURRENT YEAR- ACTUAL REV, EXP AND ENC	PRIOR YEAR- ACTUAL REV, EXP & ENC
<b><u>REVENUES &amp; OTHER RESOURCES</u></b>			
<b>Revenues</b>			
Local Revenues	\$ 1,659,821	\$ 470,497	\$ 300,639
State Program Revenue	-	-	-
Federal Program Revenue	6,494,932	2,286,595	1,485,850
<b>Total Revenues:</b>	<u>\$ 8,154,753</u>	<u>\$ 2,757,093</u>	<u>\$ 1,786,489</u>
<b>Other Resources</b>			
Transfers In	600,787	33,082	-
<b>Total Other Resources:</b>	<u>\$ 600,787</u>	<u>\$ 33,082</u>	<u>\$ -</u>
<b>Total Revenues &amp; Other Resources:</b>	<u>\$ 8,755,540</u>	<u>\$ 2,790,174</u>	<u>\$ 1,786,489</u>
<b><u>EXPENDITURES &amp; OTHER USES</u></b>			
<b>Expenditures &amp; Encumbrances</b>			
Payroll Costs	1,945,322	1,463,492	1,330,415
Contracted & Professional Services	5,830,553	4,304,746	3,874,693
Supplies & Materials	396,743	227,992	188,926
Other Operating Costs	582,922	352,311	597,564
Capital Outlay	-	-	-
<b>Total Expenditures &amp; Encumbrances:</b>	<u>\$ 8,755,540</u>	<u>\$ 6,348,541</u>	<u>\$ 5,991,598</u>
<b>Other Uses</b>			
Transfers Out	-	-	-
<b>Total Other Uses:</b>	<u>\$ -</u>	<u>\$ -</u>	<u>\$ -</u>
<b>Total Expenditures &amp; Other Uses:</b>	<u>\$ 8,755,540</u>	<u>\$ 6,348,541</u>	<u>\$ 5,991,598</u>
<b>Revenue Over/(Under) Expenditures:</b>	<u>\$ -</u>	<u>\$(3,558,367)</u>	<u>\$(4,205,109)</u>

**HARRIS COUNTY DEPARTMENT OF EDUCATION**  
**INTERIM FINANCIAL REPORTS (Unaudited)**  
**SPECIAL REVENUE FUNDS DETAIL BY DIVISION**  
**ACTUALS AND ENCUMBRANCES-CURRENT YEAR V. PRIOR YEAR**  
 Fiscal year to date: June 30, 2021

<b>Head Start Program</b>			
	CURRENT YEAR- BUDGET	CURRENT YEAR- ACTUAL REV, EXP AND ENC	PRIOR YEAR- ACTUAL REV, EXP & ENC
<b><u>REVENUES &amp; OTHER RESOURCES</u></b>			
<b>Revenues</b>			
Local Revenues	\$ 4,979,102	\$ 2,459,186	\$ 3,463,689
State Program Revenue	-	-	-
Federal Program Revenue	32,570,891	11,170,369	10,824,833
<b>Total Revenues:</b>	<u>\$ 37,549,993</u>	<u>\$ 13,629,555</u>	<u>\$ 14,288,523</u>
<b>Other Resources</b>			
Transfers In	572,000	142,859	126,227
<b>Total Other Resources:</b>	<u>\$ 572,000</u>	<u>\$ 142,859</u>	<u>\$ 126,227</u>
<b>Total Revenues &amp; Other Resources:</b>	<u>\$ 38,121,993</u>	<u>\$ 13,772,414</u>	<u>\$ 14,414,749</u>
<b><u>EXPENDITURES &amp; OTHER USES</u></b>			
<b>Expenditures &amp; Encumbrances</b>			
Payroll Costs	15,149,917	9,690,301	9,853,820
Contracted & Professional Services	3,658,587	2,843,525	2,120,108
Supplies & Materials	3,129,495	856,424	696,108
Other Operating Costs	6,202,716	2,732,256	3,621,382
Capital Outlay	9,981,278	313,836	18,731
<b>Total Expenditures &amp; Encumbrances:</b>	<u>\$ 38,121,993</u>	<u>\$ 16,436,343</u>	<u>\$ 16,310,149</u>
<b>Other Uses</b>			
Transfers Out	-	-	-
<b>Total Other Uses:</b>	<u>\$ -</u>	<u>\$ -</u>	<u>\$ -</u>
<b>Total Expenditures &amp; Other Uses:</b>	<u>\$ 38,121,993</u>	<u>\$ 16,436,343</u>	<u>\$ 16,310,149</u>
<b>Revenue Over/(Under) Expenditures:</b>	<u>\$ -</u>	<u>\$(2,663,928)</u>	<u>\$(1,895,400)</u>

**HARRIS COUNTY DEPARTMENT OF EDUCATION**  
**INTERIM FINANCIAL REPORTS (Unaudited)**  
**SPECIAL REVENUE FUNDS DETAIL BY DIVISION**  
**ACTUALS AND ENCUMBRANCES-CURRENT YEAR V. PRIOR YEAR**  
 Fiscal year to date: June 30, 2021

<b>The Teaching and Learning Center</b>
---

	CURRENT YEAR- BUDGET	CURRENT YEAR- ACTUAL REV, EXP AND ENC	PRIOR YEAR- ACTUAL REV, EXP & ENC
<b><u>REVENUES &amp; OTHER RESOURCES</u></b>			
<b>Revenues</b>			
Local Revenues	\$ -	\$ -	\$ -
State Program Revenue	-	-	-
Federal Program Revenue	41,216	-	-
<b>Total Revenues:</b>	<b>\$ 41,216</b>	<b>\$ -</b>	<b>\$ -</b>
<b>Other Resources</b>			
Transfers In	-	-	-
<b>Total Other Resources:</b>	<b>\$ -</b>	<b>\$ -</b>	<b>\$ -</b>
<b>Total Revenues &amp; Other Resources:</b>	<b>\$ 41,216</b>	<b>\$ -</b>	<b>\$ -</b>
<b><u>EXPENDITURES &amp; OTHER USES</u></b>			
<b>Expenditures &amp; Encumbrances</b>			
Payroll Costs	13,350	9,368	-
Contracted & Professional Services	21,840	21,840	-
Supplies & Materials	4,463	-	-
Other Operating Costs	1,563	-	-
Capital Outlay	-	-	-
<b>Total Expenditures &amp; Encumbrances:</b>	<b>\$ 41,216</b>	<b>\$ 31,208</b>	<b>\$ -</b>
<b>Other Uses</b>			
Transfers Out	-	-	-
<b>Total Other Uses:</b>	<b>\$ -</b>	<b>\$ -</b>	<b>\$ -</b>
<b>Total Expenditures &amp; Other Uses:</b>	<b>\$ 41,216</b>	<b>\$ 31,208</b>	<b>\$ -</b>
<b>Revenue Over/(Under) Expenditures:</b>	<b>\$ -</b>	<b>\$(31,208)</b>	<b>\$ -</b>

**HARRIS COUNTY DEPARTMENT OF EDUCATION**  
**INTERIM FINANCIAL REPORTS (Unaudited)**  
**SPECIAL REVENUE FUNDS DETAIL BY DIVISION**  
**ACTUALS AND ENCUMBRANCES-CURRENT YEAR V. PRIOR YEAR**  
 Fiscal year to date: June 30, 2021

**Center for Safe and Secure Schools**

	CURRENT YEAR- BUDGET	CURRENT YEAR- ACTUAL REV, EXP AND ENC	PRIOR YEAR- ACTUAL REV, EXP & ENC
<b><u>REVENUES &amp; OTHER RESOURCES</u></b>			
<b>Revenues</b>			
Local Revenues	\$ 197,068	\$ 35,887	\$ 10,411
State Program Revenue	-	-	-
Federal Program Revenue	381,570	119,951	79,928
<b>Total Revenues:</b>	<u>\$ 578,638</u>	<u>\$ 155,838</u>	<u>\$ 90,339</u>
<b>Other Resources</b>			
Transfers In	-	-	-
<b>Total Other Resources:</b>	<u>\$ -</u>	<u>\$ -</u>	<u>\$ -</u>
<b>Total Revenues &amp; Other Resources:</b>	<u>\$ 578,638</u>	<u>\$ 155,838</u>	<u>\$ 90,339</u>
<b><u>EXPENDITURES &amp; OTHER USES</u></b>			
<b>Expenditures &amp; Encumbrances</b>			
Payroll Costs	285,585	116,086	88,740
Contracted & Professional Services	159,543	68,500	4,231
Supplies & Materials	7,225	1,515	3,629
Other Operating Costs	126,285	8,147	2,035
Capital Outlay	-	-	-
<b>Total Expenditures &amp; Encumbrances:</b>	<u>\$ 578,638</u>	<u>\$ 194,247</u>	<u>\$ 98,636</u>
<b>Other Uses</b>			
Transfers Out	-	-	-
<b>Total Other Uses:</b>	<u>\$ -</u>	<u>\$ -</u>	<u>\$ -</u>
<b>Total Expenditures &amp; Other Uses:</b>	<u>\$ 578,638</u>	<u>\$ 194,247</u>	<u>\$ 98,636</u>
<b>Revenue Over/(Under) Expenditures:</b>	<u>\$ -</u>	<u>\$(38,410)</u>	<u>\$(8,297)</u>



**HARRIS COUNTY DEPARTMENT OF EDUCATION**  
**INTERIM FINANCIAL REPORTS (Unaudited)**  
**SPECIAL REVENUE FUNDS DETAIL BY DIVISION**  
**ACTUALS AND ENCUMBRANCES-CURRENT YEAR V. PRIOR YEAR**  
 Fiscal year to date: June 30, 2021

<b>Special Schools - ABS East</b>			
	CURRENT YEAR- BUDGET	CURRENT YEAR- ACTUAL REV, EXP AND ENC	PRIOR YEAR- ACTUAL REV, EXP & ENC
<b><u>REVENUES &amp; OTHER RESOURCES</u></b>			
<b>Revenues</b>			
Local Revenues	\$ -	\$ -	\$ -
State Program Revenue	-	-	-
Federal Program Revenue	-	-	-
<b>Total Revenues:</b>	<u>\$ -</u>	<u>\$ -</u>	<u>\$ -</u>
<b>Other Resources</b>			
Transfers In	19,698	17,134	-
<b>Total Other Resources:</b>	<u>\$ 19,698</u>	<u>\$ 17,134</u>	<u>\$ -</u>
<b>Total Revenues &amp; Other Resources:</b>	<u>\$ 19,698</u>	<u>\$ 17,134</u>	<u>\$ -</u>
<b><u>EXPENDITURES &amp; OTHER USES</u></b>			
<b>Expenditures &amp; Encumbrances</b>			
Payroll Costs	-	-	11,523
Contracted & Professional Services	-	-	-
Supplies & Materials	-	-	3,990
Other Operating Costs	19,698	19,698	-
Capital Outlay	-	-	-
<b>Total Expenditures &amp; Encumbrances:</b>	<u>\$ 19,698</u>	<u>\$ 19,698</u>	<u>\$ 15,514</u>
<b>Other Uses</b>			
Transfers Out	-	-	-
<b>Total Other Uses:</b>	<u>\$ -</u>	<u>\$ -</u>	<u>\$ -</u>
<b>Total Expenditures &amp; Other Uses:</b>	<u>\$ 19,698</u>	<u>\$ 19,698</u>	<u>\$ 15,514</u>
<b>Revenue Over/(Under) Expenditures:</b>	<u>\$ -</u>	<u>\$(2,564)</u>	<u>\$(15,514)</u>

**HARRIS COUNTY DEPARTMENT OF EDUCATION**  
**INTERIM FINANCIAL REPORTS (Unaudited)**  
**SPECIAL REVENUE FUNDS DETAIL BY DIVISION**  
**ACTUALS AND ENCUMBRANCES-CURRENT YEAR V. PRIOR YEAR**  
 Fiscal year to date: June 30, 2021

<b>Technology Support Services</b>
------------------------------------

	CURRENT YEAR- BUDGET	CURRENT YEAR- ACTUAL REV, EXP AND ENC	PRIOR YEAR- ACTUAL REV, EXP & ENC
<b><u>REVENUES &amp; OTHER RESOURCES</u></b>			
<b>Revenues</b>			
Local Revenues	\$ -	\$ -	\$ -
State Program Revenue	-	-	-
Federal Program Revenue	-	-	22,854
<b>Total Revenues:</b>	\$ -	\$ -	\$ 22,854
<b>Other Resources</b>			
Transfers In	73,995	40,311	-
<b>Total Other Resources:</b>	\$ 73,995	\$ 40,311	\$ -
<b>Total Revenues &amp; Other Resources:</b>	\$ 73,995	\$ 40,311	\$ 22,854
<b><u>EXPENDITURES &amp; OTHER USES</u></b>			
<b>Expenditures &amp; Encumbrances</b>			
Payroll Costs	-	-	5,317
Contracted & Professional Services	-	-	-
Supplies & Materials	-	-	706
Other Operating Costs	73,995	70,311	876
Capital Outlay	-	-	-
<b>Total Expenditures &amp; Encumbrances:</b>	\$ 73,995	\$ 70,311	\$ 6,899
<b>Other Uses</b>			
Transfers Out	-	-	-
<b>Total Other Uses:</b>	\$ -	\$ -	\$ -
<b>Total Expenditures &amp; Other Uses:</b>	\$ 73,995	\$ 70,311	\$ 6,899
<b>Revenue Over/(Under) Expenditures:</b>	\$ -	\$(30,000)	\$ 15,955

**HARRIS COUNTY DEPARTMENT OF EDUCATION**  
**INTERIM FINANCIAL REPORTS (Unaudited)**  
**SPECIAL REVENUE FUNDS DETAIL BY DIVISION**  
**ACTUALS AND ENCUMBRANCES-CURRENT YEAR V. PRIOR YEAR**  
 Fiscal year to date: June 30, 2021

<b>COVID-19 Disaster Recovery</b>
-----------------------------------

	CURRENT YEAR- BUDGET	CURRENT YEAR- ACTUAL REV, EXP AND ENC	PRIOR YEAR- ACTUAL REV, EXP & ENC
<b><u>REVENUES &amp; OTHER RESOURCES</u></b>			
<b>Revenues</b>			
Local Revenues	\$ -	\$ -	\$ -
State Program Revenue	-	-	-
Federal Program Revenue	-	-	-
<b>Total Revenues:</b>	\$ -	\$ -	\$ -
<b>Other Resources</b>			
Transfers In	-	-	135,796
<b>Total Other Resources:</b>	\$ -	\$ -	\$ 135,796
<b>Total Revenues &amp; Other Resources:</b>	\$ -	\$ -	\$ 135,796
<b><u>EXPENDITURES &amp; OTHER USES</u></b>			
<b>Expenditures &amp; Encumbrances</b>			
Payroll Costs	-	-	-
Contracted & Professional Services	-	-	-
Supplies & Materials	-	-	4,176
Other Operating Costs	-	-	-
Capital Outlay	-	-	-
<b>Total Expenditures &amp; Encumbrances:</b>	\$ -	\$ -	\$ 4,176
<b>Other Uses</b>			
Transfers Out	-	-	-
<b>Total Other Uses:</b>	\$ -	\$ -	\$ -
<b>Total Expenditures &amp; Other Uses:</b>	\$ -	\$ -	\$ 4,176
<b>Revenue Over/(Under) Expenditures:</b>	\$ -	\$ -	\$ 131,620

**HARRIS COUNTY DEPARTMENT OF EDUCATION**  
**INTERIM FINANCIAL REPORTS (Unaudited)**  
**SPECIAL REVENUE FUNDS DETAIL BY DIVISION**  
**ACTUALS AND ENCUMBRANCES-CURRENT YEAR V. PRIOR YEAR**  
 Fiscal year to date: June 30, 2021

<b>Total Special Revenue Fund</b>			
	CURRENT YEAR- BUDGET	CURRENT YEAR- ACTUAL REV, EXP AND ENC	PRIOR YEAR- ACTUAL REV, EXP & ENC
<b><u>REVENUES &amp; OTHER RESOURCES</u></b>			
<b>Revenues</b>			
Local Revenues	\$ 6,837,099	\$ 2,965,570	\$ 3,774,739
State Program Revenue	-	-	-
Federal Program Revenue	43,599,298	15,893,953	15,399,106
<b>Total Revenues:</b>	<u>\$ 50,436,397</u>	<u>\$ 18,859,522</u>	<u>\$ 19,173,844</u>
<b>Other Resources</b>			
Transfers In	1,485,977	423,637	262,023
<b>Total Other Resources:</b>	<u>\$ 1,485,977</u>	<u>\$ 423,637</u>	<u>\$ 262,023</u>
<b>Total Revenues &amp; Other Resources:</b>	<u>\$ 51,922,374</u>	<u>\$ 19,283,160</u>	<u>\$ 19,435,867</u>
<b><u>EXPENDITURES &amp; OTHER USES</u></b>			
<b>Expenditures &amp; Encumbrances</b>			
Payroll Costs	20,169,703	13,551,124	14,129,402
Contracted & Professional Services	10,285,926	7,711,508	6,239,810
Supplies & Materials	4,176,227	1,610,451	1,625,621
Other Operating Costs	7,309,240	3,374,007	4,294,514
Capital Outlay	9,981,278	313,836	18,731
<b>Total Expenditures &amp; Encumbrances:</b>	<u>\$ 51,922,374</u>	<u>\$ 26,560,927</u>	<u>\$ 26,308,077</u>
<b>Other Uses</b>			
Transfers Out	-	-	-
<b>Total Other Uses:</b>	<u>\$ -</u>	<u>\$ -</u>	<u>\$ -</u>
<b>Total Expenditures &amp; Other Uses:</b>	<u>\$ 51,922,374</u>	<u>\$ 26,560,927</u>	<u>\$ 26,308,077</u>
<b>Revenue Over/(Under) Expenditures:</b>	<u>\$ -</u>	<u>\$(7,277,767)</u>	<u>\$(6,872,210)</u>

**HARRIS COUNTY DEPARTMENT OF EDUCATION**  
**INTERIM FINANCIAL REPORTS (Unaudited)**  
**REVENUES UPDATE - FY 2021 CUSTOMER FEES/CHARGES**  
 Fiscal year to date: June 30, 2021

	(a) BUDGET	(b) YTD ACTUAL	% REALIZED (b)/(a)
<b>REVENUES-CUSTOMER FEES &amp; CHARGES</b>			
Educator Certification & Advancement	307,045	220,275	72%
Business Support Services	80,000	100,383	125%
Center for Safe & Secure Schools	223,200	208,757	94%
Ctr A/S Summ & Exp Learn	80,000	59,880	75%
Department-Wide	540,000	-	0%
Facilities			
Records Management Services	1,710,500	1,090,522	64%
The Teaching and Learning Center			
Bilingual Education	77,000	54,295	71%
Digital Education and Innovation	236,000	167,544	71%
Early Childhood Winter Conference	85,000	62,276	73%
English Language Arts	104,500	59,828	57%
Math	168,000	61,249	36%
Professional Development	-	3,500	N/A
Science	97,000	6,875	7%
Social Studies	22,000	1,400	6%
Speaker Series	170,400	28,125	17%
Special Education	77,000	24,224	31%
Research & Evaluation Institute	149,500	111,036	74%
Texas Center for Grants Development	1,250	930	74%
Scholastic Arts	-	11,332	N/A
Special Schools & Services			
Academic and Behavior School East	3,699,730	3,476,403	94%
Academic and Behavior School West	3,222,318	2,407,066	75%
Fortis Academy	256,250	181,250	71%
Highpoint East School	2,012,977	1,536,682	76%
Technology			
Technology Support Services	3,003	-	0%
School Based Therapy Services	10,170,332	8,486,558	83%
<b>Total Revenues-Customer Fees &amp; Charges:</b>	<b>\$ 23,493,005</b>	<b>\$ 18,360,387</b>	<b>78%</b>

**Fee for Service Revenue Growth Ratio**

$$\frac{\text{Fee for Service Current Year less Fee for Service Previous Year}}{\text{Fee for Service Previous Year}} = \frac{18,360,387 - 20,286,882}{20,286,882} = -9.50\%$$

**Revenue Growth Indicator**

$$\frac{\text{Total Fee for Service Revenues (GF)}}{\text{Total Revenues}} = \frac{18,360,387}{130,123,931} = 14.11\%$$

**HARRIS COUNTY DEPARTMENT OF EDUCATION**  
**EXPENDITURES BY CLASS OBJECT GROUP - ALL FUNDS**  
 Fiscal year to date: June 30, 2021

<b>CLASS OBJECT GROUPS</b>	<b>BUDGET</b>	<b>ACTUAL EXPENDITURES PLUS ENCUMBRANCES</b>	<b>VARIANCE</b>	<b>%SPENT</b>
6100-Payroll Costs	\$ 63,626,440	\$ 45,308,832	\$ 18,317,608	71%
6200-Contracted Services	26,229,394	17,849,316	8,380,078	68%
6300-Supplies & Materials	8,785,411	3,807,004	4,978,407	43%
6400-Miscellaneous Operating Costs	17,231,870	10,362,747	6,869,123	60%
6500-Debt Service	6,169,043	3,815,312	2,353,731	61%
6600-Capital Outlay	56,332,980	14,009,763	42,323,217	24%
8900-Transfers Out	16,920,948	7,741,002	9,179,946	45%
<b>TOTAL EXPENDITURES:</b>	<b>\$ 195,296,086</b>	<b>\$ 102,893,978</b>	<b>\$ 92,402,108</b>	<b>52%</b>

NOTE: A positive balance in the expenditure variance column represents the amount available to spend as compared to the budget.

**HARRIS COUNTY DEPARTMENT OF EDUCATION**  
**INTERIM FINANCIAL REPORTS (Unaudited)**  
**CHART FOR PERFORMANCE MEASUREMENT**  
 Fiscal year to date: June 30, 2021

<b><u>BUDGET MANAGER TITLE</u></b>	<u>Revenues</u>	<u>Tax Subsidy</u>	<u>Expenditure and Encumbran</u>	<u>Includes Tax subsidy Variance</u>	<u>w/o Tax Profit Ratio</u>	<u>Profitability Variance</u>
Educator Certification & Advancement	\$ 220,275	\$ 331,202	\$ 564,923	\$(13,446)	-156%	\$(344,649)
Choice Partners Cooperative	5,785,518	-	5,921,005	(135,487)	-2%	(135,487)
Records Management	1,119,502	339,221	1,490,148	(31,425)	-33%	(370,646)
School Based Therapy Services	8,486,558	1,108,993	9,680,315	(84,764)	-14%	(1,193,757)
Schools	7,612,953	3,169,561	10,778,933	3,580	-42%	(3,165,981)

# Monthly Disbursement Report



# Fiscal Year 2020-2021

## HARRIS COUNTY DEPARTMENT OF EDUCATION

JUNE 2021 Payroll

<u>Posting Date</u>	<u>Payee/Description</u>	<u>Transaction Amount</u>
6/1/2021	MAY 2021 TRS TEXNET Payment	\$466,901.37
6/7/2021	JUNE 2021 TRS Active Care Medical Payment	338,819.00
6/8/2021	Payroll Deductions for JUNE 15TH	41,158.57
6/8/2021	IRS Tax Payment for JUNE 15TH	426,359.32
6/29/2021	Payroll Deductions for JUNE 30TH	40,429.97
6/29/2021	IRS Tax Payment for JUNE 30TH	428,182.23
Total WIRE Transfers:		\$1,741,850.46

### RECAP OF ALL DISBURSEMENTS

	<u>Checks Printed</u>	<u>PCard</u>	<u>WIRES</u>	<u>Total Disbursements</u>
Total General Operating & Payroll Clearing (100-199)	\$ 701,838.20			
Total Special Revenue (200-400)	1,311,298.54			
Total Capital Project (600)	374,926.77			
Total Internal Service/Facilities (700)	145,792.76			
Total Fiduciary (800)	-			
Total (900)	-			
Total P Card Activity		\$143,195.19		
Total ACH Transfers-Gen Operating & Payroll Clearing				
	\$2,533,856.27	\$143,195.19	\$1,741,850.46	\$4,418,901.92
Credit Card charges paid by check from above (other than P Card)	\$3,358.61			

**Harris County Department of Education**  
**Vendors with total aggregate payments of \$50,000 or more in Fiscal Year 21**  
**as of June 30, 2021**

Vendor	Vendor number	Sum of payments	Description	Contract Type
AAMA, INC.	83547	\$ 62,872.98	Service Agreement	Afterschool Program
ALDINE INDEPENDENT SCHOOL DISTRICT	10960	\$ 103,093.56	Interlocal Agreement	Interlocal Agreement
ALIEF INDEPENDENT SCHOOL DISTRICT	84484	\$ 138,211.19	Interlocal Agreement	Interlocal Agreement
APPLE INC	13330	\$ 53,205.50	Quote	Technology equipment
AVANADE INC	88584	\$ 63,200.00	Job 20/022YR	Technology Service
BLACKMON-MOORING STEAMATIC INC	15860	\$ 249,155.73	Job 19/042MJ	Facilities services
BUTLER BUSINESS PRODUCTS	17320	\$ 366,938.72	Job # 17/004KH, 17/006KH, 17/011KH, 16/011MP	Office, furniture supplies
CDW GOVERNMENT INC	18165	\$ 967,852.87	Job # 18/056KD-13	Technology equipment, supplies, consulting
CITY OF HOUSTON HEALTH DEPARTMENT	32920	\$ 96,465.00	Lease Agreement	Lease Agreement for Head Start
CITY OF HOUSTON WATER	33040	\$ 62,932.64	Service Agreement	Utilities
CLEAR CREEK ISD	82332	\$ 136,915.68	Interlocal Agreement	Interlocal Agreement
COMCAST HOLDINGS CORPORATION	88084	\$ 55,071.29	Service Agreement	Internet service
CRE8 INCORPORATED	81367	\$ 980,028.03	Job # 17/015KJ	Architectural Design services
DAHILL OFFICE TECHNOLOGY CORP	87489	\$ 50,756.05	Job # 17/026KH	Copier services
DESKOT LLC	87246	\$ 135,663.00	Job 20/039YR	Child Care Partnership for Head Start
DOUCET & ASSOCIATES INC	88662	\$ 72,518.02	Professional Service Contract	Land Surveying
DURA PIER FACILITIES SERVICES LTD	82491	\$ 116,134.29	Job # 17/020CG, 18/060JN,	Facilities services
E LEARN INC	85464	\$ 50,098.75	Adult Ed Testing Material	Sole Source
EMCOR GOWAN INC	85932	\$ 63,693.39	Job 18/060JN	AC Service
ENERGY FUTURE HOLDINGS CORP-DO NOT	88315	\$ 54,463.15	Service Agreement	Utilities
ENGLISH + ASSOCIATES ARCHITECTS INC	88648	\$ 293,275.20	Job# 20/043IA	Architectural Design services
ERC ENVIRONMENTAL & CONST SERV INC	87401	\$ 554,189.04	Job # 19/042MJ	Disaster Mitigation Commodities
EXECU TEAM STAFFING	88574	\$ 132,868.39	Job # 17/045KJ	Staffing Service
EXECUTIVE THREAT SOLUTIONS LLC	85264	\$ 191,794.00	Job #16/060CG, Service Agreement	Security service
FELLOWSHIP OF PURPOSE EARLY CHILDHOOD	87181	\$ 79,467.00	Job # 16/014YR, Service Agreement	Service Agreement
GALENA PARK ISD	27070	\$ 336,599.25	Interlocal Agreement	Interlocal Agreement
HALLMARK OFFICE PRODUCTS INC	29505	\$ 60,276.79	Job # 19/025KD	Office furniture and supplies
HARRIS COUNTY APPRAISAL DISTRICT	29680	\$ 180,901.00	Per Texas Law/Linebarger	Tax appraisal
HARRIS COUNTY TREASURER	29920	\$ 430,419.00	Service Agreement	Security Service
HIGH POINT SANITARY SOLUTIONS	31325	\$ 116,380.31	Job # 18/007KD, 18/075KD	Sanitation supplies
HILLCO PARTNERS LLC	87257	\$ 230,000.00	Job #20/038KJ	Contracted Services
HOUSTON ISD	32530	\$ 140,291.23	Interlocal Agreement	Interlocal Agreement
HUMBLE INDEPENDENT SCHOOL DISTRICT	33610	\$ 159,725.69	Interlocal Agreement	Interlocal Agreement
IMAGINE LEARNING INCORPORATED	83848	\$ 298,200.00	Buyboard contract #579-19	Head Start subscription
KAPLAN EARLY LEARNING COMPANY	35683	\$ 114,648.82	Job #18/058KC, #17/046MR	Educational Supplies
KARCZEWSKI BRADSHAW LLP	87975	\$ 262,547.47	Professional Service Contract	Legal Services
KQC INVESTORS, LLC	83870	\$ 538,473.27	Lease Agreement	Lease Agreement for Head Start
LABATT INSTITUTIONAL SUPPLY COMPANY	86944	\$ 186,695.36	Job # 16/029TJ-03	Meals for Head Start
LOCKWOOD, ANDREWS & NEWNAM INC	88484	\$ 354,298.99	Job # 20/055KJ	Construction Management
MCGRIFF SEIBELS & WILLIAMS OF	39976	\$ 473,729.40	Job # 17/002LB	HCDE Insurance
METROPOLITAN LANDSCAPE MGMT INC	82060	\$ 138,431.66	Job # 15/023JN	Landscape service
METROPOLITAN LIFE INSURANCE COMPANY	87340	\$ 88,778.59	Agreement	Insurance Coverage
MOAK CASEY & ASSOCIATES INC	86264	\$ 53,000.00	Professional Service Contract	Accounting Service
NASH INDUSTRIES INC	88594	\$ 252,483.77	Job # 20/017MR	Service Agreement
NEIGHBORHOOD CENTERS INC	43683	\$ 78,047.76	Lease Agreement	Lease Agreement for Head Start
PASADENA ISD	45610	\$ 91,816.31	Interlocal Agreement	Interlocal Agreement
POWERSCHOOL GROUP LLC	87278	\$ 114,593.15	Invoice	Sungard Annual maintenance renewal
PS LIGHTWAVE INC	86862	\$ 73,623.42	Job # 15/006MP	Technology Equipment/Supplies
PUBLIC AGENCY RETIREMENT SERVICES	60818	\$ 333,799.16	Payroll deduction	Payroll deduction
QSS, L.C	47923	\$ 270,517.36	Job # 15/037JN	Security equipment
SHELDON INDEPENDENT SCHOOL DISTRICT	52120	\$ 432,750.91	Interlocal Agreement	Interlocal Agreement
SHI GOVERNMENT SOLUTIONS INC	52199	\$ 130,461.90	Job # 18/056KD-13	Technology Equipment/Supplies
SOA FIN1ST	84623	\$ 75,913.50	Job #20/019KJ	Accounting Service
SOUTHWEST CHARTER SCHOOL	83777	\$ 193,339.70	Interlocal Agreement	Interlocal Agreement
SPRING INDEPENDENT SCHOOL DISTRICT	53950	\$ 67,021.52	Interlocal Agreement	Interlocal Agreement
TEJANO CENTER FOR COMMUNITY CONCERN	86200	\$ 61,957.75	Interlocal Agreement	Interlocal Agreement
TEXAS POLITICAL SUBDIVISIONS	58844	\$ 113,099.08	Insurance	Insurance Coverage
THE STANDARD LIFE INSURANCE	81820	\$ 144,163.40	Insurance	Insurance Coverage
THE TURNING POINT INC	87848	\$ 116,059.96	Job # 17/043KJ	Counseling Services
UNGERBOECK SOFTWARE INTERNATIONAL	86537	\$ 75,256.25	Service Agreement	Software
UNUM LIFE INSURANCE CO OF AMERICA	39630	\$ 108,910.16	Insurance	Employee's life insurance
UNUM LIFE INSURANCE CO. OF AMERICA	87696	\$ 163,502.10	Payroll deduction	Employee's life insurance
VERIZON WIRELESS	61927	\$ 164,669.09	GSA Contract	Wireless Service
VERSA CREATIVE GROUP LLC	88087	\$ 968,871.62	Job # 19/047KC	Marketing
VISTRA PREFERRED INC	88303	\$ 339,461.16	Service Agreement	Electrical service
ZIEBEN FOUNDATION PROPERTIES	64845	\$ 56,018.48	Lease Agreement	Lease Agreement for Head Start

HARRIS COUNTY DEPARTMENT OF EDUCATION  
Procurement Card Report - May 2021

Description

Beginning	94
New	0
Closed	3
<b>Total:</b>	<b>91</b>

BUDGET MANAGER

Budget  
Manager  
Codes

Division

201	Adult Education	3
050	Business Support Services	1
925	Communications and Public Information	2
922	Cooperative for Afterschool Enrichment	3
901	Head Start	5
030	Human Resources	2
092	Client Engagement	3
924	Research and Evaluation	2
923	Center for Grants Development	1
014	Educator Certification and Professional Advancement	1
005	Center for Safe and Secure Schools	4
<b>Administration:</b>		
011	Assistant Superintendent - Parker	2
012	Assistant Superintendent- Rodgers	2
094	Special Assistant to the Superintendent	1
	Chief of Staff for the Superintendent	1
001	Superintendent	1
	Executive Assistant to Board of Trustees	0
<b>Facilities:</b>		
799	Facility Support Services	20
089	Choice Facility Partners	10
955	Gulf Coast Food Cooperative	1
<b>Instructional Support Services:</b>		
	Teaching and Learning Center Administration	4
304	TLC - Special Populations	1
303	TLC - Science	1
302	TLC - Math	1
307	TLC - English/Language Arts	1
	TLC - Special Projects	1
<b>Purchasing Services:</b>		
950	Purchasing	0
<b>Schools Division:</b>		
131	AB - East	2
132	AB - West	2
970	Highpoint - East	1
	Fortis Academy	1
111	Special Education Therapy Services	2
501	Special Schools Administration	4
<b>Technology:</b>		
093	Chief Information Officer	3
954	Records Management Services	2
091	Texas Virtual Schools	0
<b>Total:</b>		<u><u>91</u></u>

**Procurement Card Report (P-Card)  
Vendor Payments Over \$2,000  
September 1, 2020 to May 31, 2021**

\*Highlighted items are newly added transactions for the current month

Merchant Name	Transactions	
	Count	Amount
AMAZON	674	\$ 57,861.64
BUTLER BUSINESS PRODUCTS	99	\$ 13,758.90
COMCAST HOUSTON	1	\$ 2,015.77
IDENTOGO -TX FINGERPRINTING SERVICE	126	\$ 5,644.50
FELLOWES, INC.	1	\$ 2,815.98
PEPBOYS STORE	49	\$ 8,964.48
TASBO	91	\$ 29,101.00
WALMART/SAM'S CLUB	497	\$ 58,531.86
THE HOME DEPOT	371	\$ 32,395.98
BESTBUY	25	\$ 4,011.34
CHICK-FIL-A	52	\$ 7,216.81
HOUSTON PERMITTING CENTER	21	\$ 7,118.28
IN*TRANSACTIONS (MISC.)	88	\$ 27,007.80
OFFICE MAX/DEPOT	86	\$ 11,107.89
PAYPAL TRANSACTIONS	41	\$ 19,094.90
GRAINGER	58	\$ 12,880.52
INDEED	43	\$ 18,836.81
ZERO TO THREE NATIONAL CENTER	2	\$ 7,267.00
USPS POST OFFICE	282	\$ 9,788.88
ZOOM.US	89	\$ 5,914.01
FP MAILING SOLUTIONS	17	\$ 11,353.00
JASON'S DELI	47	\$ 4,523.64
JOHNSTONE SUPPLY	14	\$ 3,250.02
AMERICAN REGISTRY	3	\$ 3,612.00
J. HARDING & CO.	19	\$ 7,200.21
UNITED REFRIGERATION, INC.	36	\$ 6,896.43
ACE MART	5	\$ 3,727.59
EIG*TRANSACTIONS (MISC.)	31	\$ 6,797.62
JOHNSON SUPPLY	37	\$ 6,679.55
SQ*TRANSACTIONS (MISC.)	23	\$ 3,795.06
HUBSPOT, INC.	9	\$ 3,600.00
STK*SHUTTERSTOCK	3	\$ 2,873.00
TASA AUTHNET	12	\$ 3,059.00
ALONTI CAFÉ & CATERING	20	\$ 3,981.39
ASBO (Association for School Business Officials)	2	\$ 2,290.00
CRISIS PREVENTION	6	\$ 4,089.28
FOUNDATIONS	1	\$ 3,498.30
GOVERNMENT FINANCE OFFICERS OF TEXAS	6	\$ 2,450.00
HMNS ONLINE	2	\$ 2,350.00

**Procurement Card Report (P-Card)  
Vendor Payments Over \$2,000  
September 1, 2020 to May 31, 2021**

\*Highlighted items are newly added transactions for the current month

Merchant Name	Transactions	
	Count	Amount
LASERFICHE	7	\$ 3,393.00
TABSE STATE CONFERENCE 2021	13	\$ 2,273.51
O'REILLY AUTO PARTS	20	\$ 2,412.28
EXXONMOBIL	95	\$ 3,967.50
LA MADELEINE	19	\$ 3,676.07
CE HOUSTON	11	\$ 5,999.45
SUMMIT ELECTRIC SUPPLY	16	\$ 3,545.30
ZACHRY PUBLICATIONS	4	\$ 2,350.00
CHEVRON	49	\$ 2,378.90
EB TRANSACTIONS (EVENTBRITE, INC.)	7	\$ 2,459.16
LOWES	48	\$ 4,119.28
TST* TRANSACTIONS (TOAST, INC.)	22	\$ 3,102.55
CENTRAL SUSQUEHANNA INTERMEDIATE UNIT	20	\$ 7,980.00
LIBERTY DATA PRODUCTS	6	\$ 2,700.57
LUBYS CAFÉ	25	\$ 2,436.15
NSPRA (NATIONAL SCHOOLS PUBLIC RELATIONS ASSOCIATION)	4	\$ 2,605.00
SCHOOL SAFETY	2	\$ 3,000.00
TASN (TEXAS ASSOCIATION FOR SCHOOL NUTRITION)	5	\$ 4,283.00
TEXAS SCHOOL OF PUBLIC RELATIONS	4	\$ 6,200.00
4IMPRINT	10	\$ 7,791.73
AIR (ASSOCIATION FOR INSTITUTIONAL RESEARCH)	5	\$ 2,745.00
BLN*MONDAY.COM	1	\$ 2,572.02
CAREER EDUCATION	2	\$ 7,200.00
EVAL SYSTEMS TEST FEE	4	\$ 2,200.00
FUNCTIONFOX SYSTEMS	3	\$ 2,220.00
HL FLAKE COMPANY	8	\$ 2,291.97
HOUSTON HUMAN RESOURCES	5	\$ 3,075.00
NIGP - IWEB	1	\$ 3,000.00
SCHOOL NUTRITION ASSOCIATION	9	\$ 2,438.50
TEACHSTONE TRAINING	8	\$ 16,550.00
TEXAS ASSOCIATION OF SCHOOL BOARDS (TASB)	6	\$ 2,875.00
TEXAS NETWORK OF YOUTH SERVICES	1	\$ 2,530.00
TX HHSC CLL FEE (TX HEALTH AND HUMAN SERVICES CHILD CARE LICENSING)	46	\$ 2,130.94
PANERA BREAD	8	\$ 2,449.05
PIZZA HUT	21	\$ 2,190.53
KALAHARI RESORT	18	\$ 5,024.95
Total Vendor Charges > \$2,000	3,522	\$ 565,526.85
Total Vendor Charges < \$2,000	1,452	\$ 181,001.82
<b>Total Year-to-Date Vendor Charges</b>	<b>4,974</b>	<b>\$ 746,528.67</b>

# HCDE Procurement Card Report

June Statement

## 001 - Superintendent's Office

2021-05-20	HARRYS RESTAURANT HOUS	64150000	Business meeting meals	\$65.02
2021-05-25	SALTGRASS KATY FREEWAY	64150000	Business meeting meals	\$143.68

**001 - Superintendent's Office \$208.70**

## 005 - Center for Safe and Secure Schools

2021-05-04	BUTLER BUSINESS PRODUC	63990000	General Supplies	\$21.18
2021-05-05	WILLIE G'S POST OAK	64150000	Lunch for E&E Team Meeting	\$177.29
2021-05-09	SOUTHWES 5262384743954	64130000	Round Trip Flight for National School Safety Conf.	\$258.96
2021-05-11	LA MADELEINE TANGLEWOO	64180000	Breakfast for CSSS Team Meeting	\$78.00
2021-05-12	BUTLER BUSINESS PRODUC	63990000	General Supplies	\$389.82
2021-05-12	BUTLER BUSINESS PRODUC	63990000	General Supplies	\$15.36
2021-05-17	BUTLER BUSINESS PRODUC	63990000	General Supplies	\$75.47
2021-05-17	BUTLER BUSINESS PRODUC	63990000	General Supplies	\$227.98
2021-05-18	BUTLER BUSINESS PRODUC	63990000	General Supplies	\$8.65
2021-05-20	BUTLER BUSINESS PRODUC	63990000	Credit - General Supplies	(\$20.65)
2021-05-20	CANVA* 03061-16887910	64990000	Canva Pro Subscription	\$239.75
2021-05-28	TASA AUTHNET	64140000	Conference Registration TCWSE - To Be Cancelled	\$150.00
2021-06-04	FEDEX OFFIC21100021113	63960000	Printing	\$47.70
2021-06-04	FEDEX OFFIC21100021113	63960000	Printing	\$37.80
2021-06-06	MENTIMETER	64990000	Mentimeter Eduational Pro	\$179.88
2021-06-06	AMZN MKTP US*2X51W6J70	63990000	General Supplies	\$133.87

**005 - Center for Safe and Secure Schools \$2,021.06**

## 010 - Board of Trustees

2021-05-20	TST* GATLIN S BBQ	64150000	Business meeting meal	\$444.99
2021-06-03	ALONTI CAFE & CATERING	64150000	Business meeting meal	\$359.63
2021-06-03	BUTLER BUSINESS PRODUC	63990000	General supplies - ink for board member	\$704.97
2021-06-04	THE PLANTATION CATERIN	64150000	Business meeting meal	\$325.12
2021-06-04	BUTLER BUSINESS PRODUC	63990000	General supplies	\$171.99

**010 - Board of Trustees \$2,006.70**

## 011 - Assistant Superintendent-Parker

2021-05-12	DOLLARTREE	63990000	Supplies for SuperMentor program, JD Walker	\$16.00
2021-05-18	PAPPADEAUX SEAFOOD #76	64150000	Business Meeting Meal, Jonathan Parker	\$135.32
2021-05-25	KALAHARI RESORT - TX -	64110000	Hotel deposit for Theresa Perez	\$243.99
2021-05-25	TASBO	64140000	Registration fees for classes, Theresa Perez	\$645.00
2021-05-26	97185 - GREENWAY PLAZA	64170000	Parking expense, Jonathan Parker	\$6.00
2021-05-28	PAPPAS BURGER #082	64150000	Business Meeting meal, Jonathan Parker	\$76.84
2021-06-01	TST* CAFE EXPRESS - RI	64150000	Business Mtg. meal for Senior Directors	\$152.86

**011 - Assistant Superintendent-Parker \$1,276.01**

## HCDE Procurement Card Report - June Statement

### 012 - Assistant Superintendent-McLeod

2021-05-05	OFFICE DEPOT #2809	63990000	Supplies	\$96.55
2021-05-06	WAL-MART #4298	63990000	Supplies	\$12.68
2021-05-07	AMZN MKTP US*2L5QO4VX1	63990000	Supplies	\$100.20
2021-05-13	AMZN MKTP US*2L5AR9RD1	63990000	Supplies	\$211.98
2021-05-13	JASON'S DELI TNY 028	64150000	Lunch for E&E Planning Meeting 5/13/21	\$93.62
2021-06-03	AMZN MKTP US*2X1902GX1	63990000	Supplies	\$50.99
2021-06-03	AMAZON.COM*2X7U89CL0	63990000	Supplies	\$7.99
2021-06-03	TST* THE BREAKFAST KLU	64150000	Breakfast for Community Collaboration Meeting	\$30.41
2021-06-06	AMZN MKTP US*2X4ZK93B0	63990000	Supplies	\$195.25
2021-06-06	AMZN MKTP US*2X2L114O2	63990000	Supplies	\$16.98

**012 - Assistant Superintendent-McLeod \$816.65**

### 014 - Alternative Teacher Certification

2021-05-05	SPANISH FLOWERS RESTAU	64150000	business meeting meals - ECA - Lidia Zatopek	\$88.75
2021-05-14	EVAL SYSTEMS TEST FEE	63910000	Instructional Material - ECA - Lidia Zatopek	\$550.00

**014 - Alternative Teacher Certification \$638.75**

### 030 - Human Resources

2021-05-10	ZIPRECRUITER, INC.	64960000	Job posting advertisement - L. Nilon	\$1,009.00
2021-05-11	IDENTOGO - TX FINGERPR	62990000	fingerprinting for applicant	\$49.25
2021-05-12	AMAZON.COM*2L3R34UP1	63990000	Office supplies	\$23.39
2021-05-13	KROGER #314	64160025	Retirement Flowers given on Appreciation Day	\$210.00
2021-05-14	AMAZON.COM*2L8PM1Y51	63990000	Office supplies	\$68.37
2021-05-17	IDENTOGO - TX FINGERPR	62990000	Fingerprinting for applicant	\$49.25
2021-05-17	IDENTOGO - TX FINGERPR	62990000	Fingerprinting for applicant	\$49.25
2021-05-18	OFFICE DEPOT #2809	63990000	Office supplies	\$162.85
2021-05-21	TASPA	64140000	Conference - N. Truitt	\$260.00
2021-05-25	AMZN MKTP US*2R1013PB0	64990005	Wellness Program Door Prizes for June Webinar	\$62.96
2021-05-25	USPS PO 4801740017	64980000	Postage	\$12.40
2021-05-27	SAMSCLUB.COM	64990005	Medicine Cabinet Refill - Wellness Program	\$171.73
2021-05-28	KALAHARI RESORT - TX -	64110000	Conference	\$249.99
2021-05-31	INDEED	64960000	Job posting advertisement - R. Torres	\$534.06
2021-06-02	SHIPLEY YALE	64150001	National Donut Day - Employee Events	\$371.25
2021-06-02	AMAZON.COM*2X1XN3031	63990000	Office supplies	\$77.41
2021-06-02	INDEED	63990000	Job posting advertisement - R. Torres	\$90.40
2021-06-02	IDENTOGO - TX FINGERPR	62990000	Fingerprinting for applicant	\$49.25
2021-06-03	AMZN MKTP US*2R8SV9YL0	63990000	Office supplies	\$37.26
2021-06-03	SHIPLEY DO-NUTS	64150001	National Donut day	\$155.04
2021-06-04	SQ *DANNAY DONUTS	64150000	Expenses for staff	\$37.00
2021-06-04	SHIPLEY DONUTS	64150001	National Donut Day at Fortis Academy	\$18.98

**030 - Human Resources \$3,749.09**

## HCDE Procurement Card Report - June Statement

### 050 - Business Support Services

2021-05-06	TAQUERIA CHAPALA	64150000	WORKING LUNCH BEEVILLE MEETING 5.6.21 EXEC FIN DIR	\$53.01
2021-05-07	WM SUPERCENTER #5959	64180000	BUDGET MEETING REFRESHMENTS	\$80.80
2021-05-11	TASBO	64940000	DRUBIO MEMBERSHIP & REG FEE FOR TASBO	\$780.00
2021-05-11	KALAHARI RESORT - TX -	64110000	DRUBIO TASBO HOTEL RESERVATION	\$189.00
2021-05-12	PAPPAS BAR-B-Q #061Q80	64180000	BUDGET MEETING REFRESHMENTS	\$80.92
2021-05-13	NATIONAL PROCUREMENT I	64970000	JAMEZCUA NPI ACHIEVEMENT EXC APPLICATION	\$600.00
2021-05-20	AMZN MKTP US*2R2XB0F50	64990000	JAMEZCUA OFFICE SUPPLIES	\$39.70
2021-05-20	MELLOW MUSHROOM #214	64150000	BUSINESS LUNCH E FINANCE TRAINING	\$158.00
2021-05-22	AMZN MKTP US*2R91F3NQ0	63990000	JAMEZCUA OFFICE SUPPLIES	\$22.49
2021-05-24	APPLE.COM/BILL	63970000	JAMEZCUA APPLE SHOW ME SUBSCRIPTION	\$140.71
2021-05-25	INTUIT *	64990000	SHARDIN QUICKBOOKS SUBSCRIPTION	\$37.31
2021-05-28	WAL-MART #4526	64990000	SUPPLIES FOR YEARLY YOUTH CONFERENCE	\$98.70
2021-06-01	APT US&C	64970000	JAMEZCUA APT MEMBERSHIP	\$269.00
2021-06-01	APT US&C	64940000	JAMEZCUA 21 ANNUAL APT CONF REGISTRATION	\$698.00
2021-06-02	WM SUPERCENTER #5959	63990000	SUPPLIES FOR YEARLY YOUTH CONFERENCE	\$70.84
2021-06-04	HOUSTON EAST END C OF	64970000	JAMEZCUA MEMBERSHIP FEE HOUSTON EAST END CC	\$400.00
2021-06-04	AICPA *ORDER	64970000	JAMEZCUA AICPA MEMBERSHIP RENEWAL	\$385.00
2021-06-05	AMZN MKTP US*2X87K65Y1	64990000	OFFICE SUPPLIES	\$18.85
<b>050 - Business Support Services</b>				<b>\$4,122.33</b>



## HCDE Procurement Card Report - June Statement

### 083 - Facilities Support Services

2021-05-05	THE HOME DEPOT #6806	63150000	Split - Building supplies - Lindale (68.03%)	\$57.40
2021-05-05	GRAINGER	63190000	Maintenance supplies - Facilities	\$49.99
2021-05-06	THE HOME DEPOT #0577	63190000	Maintenance supplies - Facilities	\$105.80
2021-05-06	EXXONMOBIL 47902184	63110000	Gas unit45 - Facilites	\$77.02
2021-05-06	CHEVRON 0108129	63110000	Fuel for Unit #50	\$53.84
2021-05-06	SHERWIN WILLIAMS 70745	63190000	Maintenance supplies - Facilities	\$153.80
2021-05-07	THE HOME DEPOT #0577	63190000	Maintenance supplies/stripping at 6300	\$46.95
2021-05-07	THE HOME DEPOT #0577	63190000	Maintenance supplies - Facilities	\$6.48
2021-05-07	LOWES #00681*	63150000	Building supplies - 6300 Irvington	\$109.82
2021-05-07	THE HOME DEPOT #0577	63150000	Building supplies - 6300 Irvington	\$26.98
2021-05-07	KROGER #264	64150000	Staff safety meeting	\$160.75
2021-05-07	CHEVRON 0108129	63110000	Fuel Unit #50	\$25.82
2021-05-08	AMZN MKTP US*YA5J59TI3	63990000	Office Supplies Needed	\$34.78
2021-05-08	AMZN MKTP US*2L10J1H01	63990000	Office Supplies Needed	\$51.91
2021-05-10	JOHNSON SUPPLY N SHE	63190000	Maintenance supplies	\$17.10
2021-05-10	GRAINGER	63150000	Bldg supplies/kitchen supplies	\$445.56
2021-05-10	UNITED REFRIG BR #83	63190000	Maintenance supplies - Facilities	\$57.00
2021-05-10	CE HOUSTON 3759	63150000	Building supplies - NPO	\$857.36
2021-05-10	O'REILLY AUTO PARTS 40	63170000	Vehicle part - Facilities	\$148.46
2021-05-10	SHELL OIL 57543434500	63110000	Gas unit 41 - Facilities	\$40.49
2021-05-11	SQ *EZ HOSE AND FITTIN	63170000	Vehicle part - Facilities	\$150.00
2021-05-11	THE HOME DEPOT #0577	63150000	Building supplies - NPO	\$1,232.89
2021-05-11	THE HOME DEPOT #6985	63190000	Maintenance supplies - Facilities	\$331.72
2021-05-11	AMZN MKTP US*2L2695KP1	63990000	Urinal covers	\$119.90
2021-05-11	JOHNSTONE SUPPLY OF HO	63190000	Maintenance supplies - Facilities	\$64.40
2021-05-11	JOHNSTONE SUPPLY OF HO	63190000	Maintenance supplies - Facilities	\$56.37
2021-05-11	JOHNSTONE SUPPLY OF HO	63190000	Maintenance supplies - Facilities	\$35.00
2021-05-11	JOHNSON SUPPLY N SHE	63190000	Split - Maintenance Supplies - Facilities (79.87%)	\$140.50
2021-05-12	SHELL OIL 575432658QPS	63110000	Fuel for Unit #25	\$13.54
2021-05-12	THE HOME DEPOT #0577	63150000	Bldg supplies and materials	\$200.37
2021-05-12	AMAZON.COM*2L7T60951	63990000	Water Cooler cleaning kits	\$107.68
2021-05-12	OFFICE DEPOT #2809	63990000	Misc office supplies	\$19.68
2021-05-12	UNITED REFRIG BR #83	63150000	Building supplies - NPO	\$135.96
2021-05-13	THE HOME DEPOT #0577	63150000	Building supplies - NPO	\$428.10
2021-05-13	THE HOME DEPOT #6985	63190000	Maintenance supplies - Facilities	\$258.97
2021-05-13	LOWES #00681*	63190000	Maintenance supplies - Facilities	\$37.42
2021-05-13	LOWES #01145*	63190000	Maintenance supplies - Facilities	\$44.94
2021-05-13	O'REILLY AUTO PARTS 40	63150000	Building supplies - 6300 Irvington	\$9.24
2021-05-13	EXXONMOBIL 47937743	63110000	Gas unit 45 - Facilities	\$76.95
2021-05-13	TOMMIE VAUGHN PARTS	63170000	Vehicle parts unit 33 -Facilities	\$48.29
2021-05-14	WKT* ABBATRaining.COM	64940000	Training- Facilities	\$29.95
2021-05-15	FP MAILING SOLUTIONS	64980000	Postage for HCDE	\$931.50
2021-05-17	THE HOME DEPOT #6507	63190000	Maintenance supplies - Facilities	\$50.93
2021-05-17	GRAINGER	63150000	Bldg supplies & materials for 6300	\$141.43
2021-05-17	GRAINGER	63150000	Kitchen and first aide supplies for 6300	\$969.96
2021-05-17	GRAINGER	63180000	Custodial supplies for 6300	\$40.60
2021-05-17	AMZN MKTP US*2R1X003X1	63150000	Table cloths	\$148.05
2021-05-18	THE HOME DEPOT #0577	63190000	Maintenance supplies - Facilities	\$7.68
2021-05-18	THE HOME DEPOT #0577	63180000	Blower for 6005	\$284.75
			Westview/cleaning supplies	
2021-05-18	THE HOME DEPOT #6985	63190000	Maintenance supplies - Facilities	\$16.40
2021-05-18	THE HOME DEPOT #6507	63190000	Maintenance supplies - Facilities	\$41.94

## HCDE Procurement Card Report - June Statement

### 083 - Facilities Support Services

2021-05-18	AMZN MKTP US*2R6EJ1AB1	63990000	Supply Item - Facilities - JGarza	\$32.98
2021-05-18	EXXONMOBIL 47944590	63110000	Gas unit 44 - Facilities	\$72.90
2021-05-18	LOWES #00681*	63190000	Maintenance supplies	\$73.84
2021-05-18	AMZN MKTP US*2R9CP4JG1	63990000	phone supplies for Facilities	\$32.95
2021-05-19	BUTLER BUSINESS PRODUC	63990000	Coffee supplies	\$339.44
2021-05-19	THE HOME DEPOT #0569	63150000	Split - Building supplies - Lindale (70.34%)	\$37.88
2021-05-19	THE HOME DEPOT #0569	63190000	Split - Maintenance Supplies - Facilities (29.66%)	\$15.97
2021-05-19	SHERWIN WILLIAMS 70745	63190000	Maintenance supplies - Facilities	\$71.10
2021-05-19	UNITED REFRIG BR #83	63190000	Maintenance supplies - Facilities	\$114.87
2021-05-19	GRAINGER	63150000	Replacement Fridge/4th floor	\$482.45
2021-05-20	THE HOME DEPOT #0577	63190000	Maintenance supplies - Facilities	\$214.08
2021-05-20	BUTLER BUSINESS PRODUC	63990000	Coffee supplies	\$192.11
2021-05-20	BUTLER BUSINESS PRODUC	63990000	Misc coffee supplies	\$57.85
2021-05-20	FASTSIGNS	63150000	Building supplies - 6300 Irvington	\$151.29
2021-05-20	JOHNSTONE SUPPLY OF HO	63150000	Building supplies - NPO	\$188.94
2021-05-20	EXXONMOBIL 47939723	63110000	Gas unit 45-Facilities	\$75.40
2021-05-21	AMZN MKTP US*2R5OC6Z10	63190000	Maintenance supplies - Facilities	\$95.80
2021-05-21	LOWES #00681*	63190000	Maintenance supplies - Facilities	\$37.77
2021-05-21	THE HOME DEPOT #0565	63190000	Maintenance supplies - Facilities	\$127.97
2021-05-21	CE HOUSTON SE	63150000	Building supplies - Highpoint East	\$90.82
2021-05-21	M AND D DISTRIBUTORS	63170000	Vehicle parts 17 - Facilities	\$42.58
2021-05-21	LOWES #00681*	63150000	Building supplies - NPO	\$199.00
2021-05-22	AMZN MKTP US*2R9CF44H2	63190000	Maintenance supplies - Facilities	\$51.98
2021-05-22	ONE STOP MUFFLER SHOP	63170000	Inspection unit 17 - Facilities	\$7.00
2021-05-23	AMZN MKTP US*2R4LW9T40	63190000	Misc maintenance supplies	\$8.98
2021-05-24	HARRIS COUNTY TX - SCA	62470000	Vehicle registration unit 42 - Facilities	\$7.50
2021-05-24	HARRIS COUNTY TX - SCA	62470000	Conv Fee Registration - Facilities	\$0.16
2021-05-24	THE HOME DEPOT #1832	63190000	Maintenance supplies - Facilities	\$278.00
2021-05-24	THE HOME DEPOT #6806	63190000	Maintenance supplies - Facilities	\$20.69
2021-05-24	BRIO CARWASH AND DETAI	63190000	carwash for SUV - Facilities	\$55.00
2021-05-25	THE HOME DEPOT #0577	63180000	Custodial supplies	\$19.94
2021-05-25	THE HOME DEPOT #0569	63190000	Maintenance supplies - Facilities	\$31.76
2021-05-25	TASBO	64140000	TASBO Summer Solutions Conference	\$645.00
2021-05-25	IN *SWETTCORP	63150000	Building Maintenance - NPO	\$740.00
2021-05-25	AMAZON.COM*2R45K3A52	63990000	Fire Drill supplies	\$95.80
2021-05-25	TASBO	64140000	TASBO-Summer Solutions Conference	\$645.00
2021-05-25	EXXONMOBIL 47943923	63110000	Gas unit 10 - Facilities	\$70.56
2021-05-25	AMZN MKTP US*2R2TJ8SW1	63180000	Custodial supplies	\$105.50
2021-05-26	KALAHARI RESORT - TX -	64110000	Hotel Reservation for TASBO Conference	\$243.99
2021-05-26	KALAHARI RESORT - TX -	63990000	TASBO One (1) Day Hotel Reservation	\$243.99
2021-05-26	THE HOME DEPOT #0577	63190000	Maintenance supplies	\$65.91
2021-05-26	THE HOME DEPOT #0577	63190000	Maintenance supplies - Facilities	\$223.51
2021-05-26	AMZN MKTP US*2R11H90S2	63180000	Custodial supplies	\$82.76
2021-05-26	EXXONMOBIL 47939723	63110000	Gas unit 45 - Facilites	\$73.38
2021-05-26	AUTO BODY PARTS DEPOT	63170000	Vehicle parts unit 17 - Facilities	\$250.00
2021-05-26	EXPRESS TRUCK STOP	63110000	Gas unit 44 - Facilities	\$73.27
2021-05-27	THE HOME DEPOT #0577	63190000	Maintenance supplies - Facilities	\$1,583.29
2021-05-27	THE HOME DEPOT #0569	63190000	Maintenance supplies - Facilities	\$37.94
2021-05-27	KALAHARI RESORT - TX	64110000	TASBO Hotel Reservation	\$369.81

## HCDE Procurement Card Report - June Statement

### 083 - Facilities Support Services

2021-05-27	TASBO	64140000	TASBO Summer Solutions Conference	\$795.00
2021-05-27	JOHNSON SUPPLY N SHE	63190000	Maintenance supplies	\$14.25
2021-05-27	CE HOUSTON 3759	63150000	Building supplies - NPO	\$164.70
2021-05-27	O'REILLY AUTO PARTS 40	63190000	Maintenance supplies - Facilities	\$56.26
2021-05-28	THE HOME DEPOT #6806	63150000	Building supplies - 6300 Irvington	\$29.82
2021-05-28	O'REILLY AUTO PARTS 40	63170000	Vehicle part #17 - Facilities	\$36.37
2021-05-29	AMZN MKTP US	63150000	Refund for table cloths	(\$115.15)
2021-05-29	AMZN MKTP US*2X4HL1FA1	63990000	Custodial Supplies Needed	\$272.25
2021-06-01	EXXONMOBIL 47943683	63110000	Gas #45 - Facilities	\$71.57
2021-06-01	O'REILLY AUTO PARTS 40	63170000	Vehicle unit 6 - Facilities	\$63.49
2021-06-01	LOWES #01145*	63190000	Maintenance supplies - Facilities	\$33.49
2021-06-02	THE HOME DEPOT #6558	63190000	Maintenance supplies - Facilities	\$259.00
2021-06-02	ACE ELECTRONICS	63170000	Vehicle parts unit 17 - Facilities	\$62.45
2021-06-02	JOHNSON SUPPLY N SHE	63190000	Maintenance supplies	\$206.34
2021-06-02	TRIPLES STEEL HOLDIN	63190000	Maintenance supplies - Facilities	\$104.84
2021-06-02	TS DISTRIBUTORS INC	63190000	Maintenance supplies - Facilities	\$105.71
2021-06-02	AMAZON.COM*2R46A4RF0	63180000	Building supplies	\$6.97
2021-06-03	THE HOME DEPOT #0577	63990000	Bollard light supplies & power washer	\$398.99
2021-06-03	CHEVRON 0374709	63110000	Gas unit 46 - Facilities	\$71.94
2021-06-03	EXXONMOBIL 47943014	63110000	Gas unit 26 - Facilities	\$66.98
2021-06-03	AMZN MKTP US*2X17U9C10	63990000	Phone case for new employee	\$25.95
2021-06-04	XL PARTS 002	63170000	Vehicle parts unit17 -Facilities	\$44.87
2021-06-04	DAIRY QUEEN #14520 QPS	64150000	Accidental personal charge that will be reimbursed	\$18.13

**083 - Facilities Support Services      \$20,275.35**

### 084 - Facilities Operations

2021-05-11	ISI*COMMERCIAL REFRIG	63150000	Building Supplies - Highpoint East	\$39.23
2021-05-12	H.L. FLAKE COMPANY	63150000	Building supplies - ABS West	\$674.96
2021-05-13	THE HOME DEPOT #0577	63150000	Building supplies - ABS East	\$64.94
2021-05-13	THE HOME DEPOT #6509	63150000	building supplies - ABS East	\$41.82
2021-05-18	THE HOME DEPOT #0577	63150000	Building supplies - Science lad	\$23.96
2021-05-21	CE HOUSTON SE	63150000	Building supplies - Highpoint East	\$542.44
2021-05-24	O'REILLY AUTO PARTS 40	63150000	Building supplies - Science Lab	\$19.80
2021-05-25	CE HOUSTON SE	63150000	Building supplies - Highpoint East	\$501.03
2021-05-26	THE HOME DEPOT #0577	63150000	Building supplies - Fortis	\$151.40
2021-06-01	LOWES #01145*	63150000	Building supplies - ABS East	\$132.30
2021-06-02	THE HOME DEPOT #6558	63150000	Building supplies - ABS West	\$30.26
2021-06-02	THE HOME DEPOT #6558	63150000	building Supplies - ABS West	\$198.93
2021-06-02	JOHNSON SUPPLY PASADEN	63150000	Building supplies - Highpoint	\$30.87
2021-06-03	THE HOME DEPOT #0577	63150000	Building supplies - ABS West	\$20.48
2021-06-03	THE HOME DEPOT #6558	63150000	Building supplies - ABS West	\$35.00
2021-06-03	THE HOME DEPOT #0577	63150000	Building supplies - ABS West	\$159.37

**084 - Facilities Operations      \$2,666.79**

## HCDE Procurement Card Report - June Statement

### 089 - Choice Facility Partners

2021-05-04	KALAHARI RESORT - TX -	64110000	TASBO Summer Conf. 2021 A.Kyles	\$189.00
2021-05-09	KALAHARI RESORT - TX	64110000	TASBO Summer Conf. 2021 A.Kyles	\$463.05
2021-05-11	BUTLER BUSINESS PRODUC	63990000	General office supplies for CP	\$3.78
2021-05-12	BUTLER BUSINESS PRODUC	63990000	General office supplies for CP	\$97.49
2021-05-13	BUTLER BUSINESS PRODUC	63990000	General office supplies for CP	\$118.57
2021-05-13	HUBSPOT INC.	64990000	Subscription for CRM usage-Choice Partners	\$400.00
2021-05-14	NIGP - IWEB	62650000	Virtual booth/in person leadership conference	\$3,000.00
2021-05-17	SOUTHWES 5262387621790	62650000	Air to NIGP leadership conference	\$423.96
2021-05-18	PAYPAL *NAEPTOAL	62650000	Booth for TOAL - College Station	\$1,200.00
2021-05-25	FREEMAN	62660000	Booth Equipment for TASN 2021- Food Co-op	\$536.32
2021-06-02	BUTLER BUSINESS PRODUC	63990000	General office supplies for CP	\$48.55
2021-06-03	PAYPAL *STASMO	62650000	Conference registration booth	\$998.00

**089 - Choice Facility Partners \$7,478.72**

### 089 - Choice Partners

2021-05-04	KALAHARI RESORT - TX -	64110000	TASBO 2021 Sum Conf Hotel Deposit-Shandra Powell	\$189.00
2021-05-04	KALAHARI RESORT - TX	64110000	TASBO 2021 Sum Conf Hotel Balance-Shandra Powell	\$463.05
2021-05-08	AMZN MKTP US*2L4M24BM1	63990000	Triple Monitor Stand for Stand Up Desk	\$99.99
2021-05-13	INSTITUTE SUPPLY MGMT	64970000	ISM CPSM Certificate 3 year renewal fee	\$119.00
2021-05-14	TEXAS ASSN SCHOOL BOAR	62650000	2021 TASA/TASB Conf Dn Pymt-CP Exhibitor Booth	\$1,600.00
2021-05-14	NATIONAL PROCUREMENT I	64970000	NPI Membership Fee	\$130.00
2021-05-17	SOUTHWEST EXPO SERV	62660000	N&E CJAC 2021 Conf-Booth Equipment Rentals	\$183.75
2021-05-17	SOUTHWEST EXPO SERV	62660000	So TX CJAC 2021 Conf-Booth Equipment Rentals	\$198.91
2021-05-19	BROOKHOLLOW 670 EC	64150000	Food for evaluators of RFP 21/031KN.	\$58.65
2021-05-27	TEXAS MUNICIPAL LEAGUE	62650000	TML 2021- CP Exhibitor Booth	\$1,300.00
2021-05-28	AMZN MKTP US*2R75N1Q50	63990000	Wall Mount 24 Pocket BusCard Holder for CP Div.	\$44.99
2021-05-28	AMZN MKTP US*2R8UA1QN0	63990000	TOAL 2021 Conf-CP Exhibitor Booth Theme Supplies	\$29.79
2021-05-31	AMZN MKTP US*2R7E606I2	63990000	TOAL 2021 Conf-Standing Tabletop Theme Props	\$95.02
2021-06-02	TASBO	64940000	TASBO Summer Solutions '21 Course Registration	\$645.00
2021-06-06	AMZN MKTP US*2X3NA3380	63990000	Cubicle Hangers for CP Division	\$42.59

**089 - Choice Partners \$5,199.74**

## HCDE Procurement Card Report - June Statement

### 090 - Technology Support Services

2021-05-05	JAM SOFTWARE GMBH	63970001	Jam Software Renewal	\$255.54
2021-05-12	AMZN MKTP US*2L5GW9UQ1	63990000	Supply Item	\$54.98
2021-05-13	AMAZON.COM*2L0C59W21	63990000	Supply Item - Service Desk	\$43.99
2021-05-13	AMZN MKTP US	63990000	Supply Item - Amazon Return	(\$30.99)
2021-05-13	PAYPAL *LASERFICHE	64940000	Online Laserfiche Training- S. Erukulla	\$150.00
2021-05-15	AMZN MKTP US*2L2XU6DJ0	63990000	Supply Item	\$33.95
2021-05-17	AMZN MKTP US	63990000	Supply Item - Amazon Return	(\$33.95)
2021-05-20	WEB*NETWORKSOLUTIONS	62450000	Domain renewals	\$299.92
2021-05-24	CDW GOVT #D589090	63990000	Supply Item	\$78.19
2021-05-25	PAYPAL *LASERFICHE	64940000	Laserfiche Gold Cert. Training- L. Ballard	\$1,020.00
2021-05-25	AMZN MKTP US*2R6938J82	63990000	Supplies for Service Desk	\$51.96
2021-05-31	AMZN MKTP US*2R1UQ06H2	63990000	Supplies for IT Trainer	\$25.99
2021-06-03	ARIN	64990000	Registration Fee for ARN# and Public IP address	\$300.00
2021-06-04	B&H PHOTO 800-606-6969	63990000	Supply Item - JSalinas	\$128.79

**090 - Technology Support Services \$2,378.37**

### 092 - Marketing Services

2021-05-05	EIG*CONSTANTCONTACT.C O	63970000	Subscription for Constant Contact	\$415.00
2021-05-07	KALAHARI RESORT - TX -	64110000	Deposit paid for Hotel-Stephanie de Los Santos	\$199.00
2021-05-10	AMERICAN MARKETING ASS	64970000	JWachs-refund for canceled AMA event.	(\$27.00)
2021-05-24	BLN*MONDAY.COM	63970001	Software Platform	\$2,572.02
2021-06-05	EIG*CONSTANTCONTACT.C O	63970000	Subscription for Constant Contact	\$415.00

**092 - Marketing Services \$3,574.02**

### 093 - Chief Information Officer

2021-05-07	AMZN MKTP US	63990000	Credit for returned item	(\$33.51)
2021-05-07	PUBLIC RELATIONS SOCIE	64990000	Fee for job listing	\$150.00
2021-05-08	HOUSTON CHRONICLE CIRC	63290000	Online newspaper subscription for D. Clark	\$18.02
2021-06-05	HOUSTON CHRONICLE CIRC	63290000	Online newspaper subscription for D. Clark	\$18.62

**093 - Chief Information Officer \$153.13**

### 094 - External Relations

2021-05-07	ZOOM.US	63970000	Software purchases (refund)	(\$2.62)
2021-05-27	HOUSTON CHRONICLE CIRC	63290000	Reading materials	\$17.95
2021-06-02	USPS PO 4800390043	64980000	Postage for PIR AG ruling & 3rd party notification	\$233.05

**094 - External Relations \$248.38**

## HCDE Procurement Card Report - June Statement

---

### 111 - Therapy Services

2021-05-05	PESI INC	63290000	Office Staff, Therapist reading material -Barkley	\$796.95
2021-05-06	GUILFORD PUBLICATIONS	63290000	Reading supplies for district therapist	\$1,820.63
2021-05-10	KROGER #314	64180000	Staff Appreciation Refreshments	\$17.50
2021-05-12	TARGET 00019752	63990000	Staff Appreciation Materials	\$6.50
2021-05-13	KROGER #312	64180000	Staff Appreciation Refreshments	\$122.93
2021-05-13	APTA - DUES	64970000	J Calmes APTA membership dues	\$510.00
2021-05-14	PANERA BREAD #204111 O	64150000	Lunch for staff during Appreciation Day	\$1,536.25
2021-05-16	EIG*CONSTANTCONTACT.C O	64990000	Email blast	\$65.00
2021-05-24	KOJACK'S FINE FOODS	64150000	Managers Planning Meeting Lunch	\$105.29
2021-05-28	BUTLER BUSINESS PRODUC	63990000	HISD RFP Supplies	\$27.35
<b>111 - Therapy Services</b>				<b>\$5,008.40</b>

# HCDE Procurement Card Report - June Statement

## 131 - ABC East

2021-05-05	PARTY CITY 808	64990000	Expenses for Nurses week	\$32.96
2021-05-05	H-E-B #540	64990000	Expenses for teachers	\$19.22
2021-05-06	CHICK-FIL-A #03071	63410000	Expenses for students	\$363.50
2021-05-06	USPS PO 4801290015	64980000	Expenses for students	\$92.85
2021-05-06	SAMSCLUB #8244	64180000	Expenses for teachers	\$133.72
2021-05-07	H-E-B #540	64990000	Expenses for students	\$17.48
2021-05-08	USPS PO 4801290015	64980000	Expenses for students	\$9.15
2021-05-13	SAMSCLUB.COM	64990000	Expenses for students	\$73.80
2021-05-13	WALMART.COM AU	63990000	Expenses for counselor	\$178.12
2021-05-13	USPS PO 4801290015	64980000	Expenses for students	\$110.65
2021-05-13	AMZN MKTP US*2L0M82HE0	64990000	Expenses for students	\$26.98
2021-05-17	USPS PO 4801290015	64980000	Expenses for students	\$12.64
2021-05-18	H-E-B #572	63410000	Expenses for students field trips	\$24.18
2021-05-18	USPS PO 4801290015	64980000	Expenses for student mailing	\$73.14
2021-05-19	BATH AND BODY WORKS 39	64990000	Expenses for teachers	\$144.59
2021-05-19	BATH AND BODY WORKS 39	64990000	Expenses for teacher	\$16.00
2021-05-19	USPS PO 4801290015	64980000	Expenses for students mailing	\$19.76
2021-05-20	PARTY CITY 808	64990000	Expenses for teacher	\$96.11
2021-05-20	AMZN MKTP US*2R25Y8PC1	64990000	Expenses for students	\$11.46
2021-05-23	AMZN MKTP US*2R9EW54C2	64990000	Expenses for students	\$117.84
2021-05-24	H-E-B #540	64990000	Expenses for student field trip	\$33.90
2021-05-24	AQUARIUM - HOUSTON AMU	64990000	Expenses for student field trip	\$79.92
2021-05-25	USPS PO 4801290015	64980000	Expenses for students	\$24.27
2021-05-26	SHELL OIL 575430827QPS	63110000	Expense for school bus	\$76.25
2021-05-26	SAMSCLUB.COM	64990000	Expenses for students	\$73.80
2021-05-26	LOUISIANA FISH HOUSE	64150000	Crisis Leadership Team Meeting	\$270.36
2021-05-26	H-E-B #540	64990000	Expenses for teachers	\$24.92
2021-05-27	FIESTA MART #18	64990000	Expenses for students	\$40.98
2021-05-27	SAMS CLUB #4769	64990000	Expenses for students	\$402.36
2021-05-28	USPS PO 4801290015	64980000	Expenses for student mailing	\$7.96
2021-05-28	ACE MART GULF FREEWAY	64990000	Expenses for students	\$70.25
2021-06-01	PIZZA HUT 032231	63410000	Expenses for students	\$140.00
2021-06-02	PIZZA HUT 032231	63410000	Expenses for students	\$220.00
2021-06-02	H-E-B #540	64990000	Expenses for staff	\$16.77
2021-06-03	CHICK-FIL-A #03071	63410000	Expenses for students (50%)	\$505.63
2021-06-03	CHICK-FIL-A #03071	64150000	Expenses for Staff (50%)	\$505.62
2021-06-03	SAMS CLUB #8244	64180000	Expenses for Professional Development	\$5.98
2021-06-03	SAMS CLUB #8244	64180000	Expenses for Professional Development	\$123.06
2021-06-04	PARTY CITY 808	64990000	Expenses for staff	\$23.76
2021-06-04	ARNE'S	64990000	Expenses for teachers	\$218.68
2021-06-04	LOUISIANA FISH HOUSE	64150000	Expenses for Professional Development	\$510.27

**131 - ABC East      \$4,948.89**

## HCDE Procurement Card Report - June Statement

### 132 - ABC West

2021-05-03	HOUSTON MUSEUM OF NATU	64990004	Field Trip for the Students	\$48.00
2021-05-05	THE HOME DEPOT #6558	63990000	General Supplies	\$48.90
2021-05-05	MCW#3-SOUTH VOSS	63110000	ABS West Van Fuel and Cleaning	\$109.17
2021-05-05	MACGILL SCHOOL NURSE S	63990000	Supplies for the Nurse	\$473.20
2021-05-05	WM SUPERCENTER #3584	64990000	Boys Town Trading Store/ Rewards for students	\$57.28
2021-05-05	SAMSClub #4769	64990000	Boys Town Trading Store/Rewards for students	\$289.84
2021-05-05	WAL-MART #3584	63990000	General Supplies / Nurse's Office	\$66.62
2021-05-05	WAL-MART #3584	63980000	Food for Classroom for students	\$115.61
2021-05-05	USPS PO 4801500411	64980000	Certified Mail for Parents & Students	\$18.14
2021-05-06	WM SUPERCENTER #1279	63990000	General Supplies	\$43.02
2021-05-06	USPS PO 4801500411	64980000	Certified Mail for Parents & Students	\$4.40
2021-05-06	AMZN MKTP US*2L3EH9PX1	63990000	Supplies for the Nurse	\$12.99
2021-05-07	CI CIS #835	64990000	Boys Town / ABA rewards for students CiCi's Pizza	\$318.46
2021-05-07	USPS PO 4801500411	64980000	Certified Mail for Parents & Students	\$33.25
2021-05-08	LIBERTY DATA PRODUCTS	63990000	General Supplies for Teachers	\$131.96
2021-05-08	LIBERTY DATA PRODUCTS	63990000	General Supplies for Teachers	\$201.02
2021-05-08	LIBERTY DATA PRODUCTS	63990000	General Supplies for Administration	\$131.96
2021-05-10	SAMS CLUB #8245	63990000	General Supplies	\$43.44
2021-05-10	SAMS CLUB #8245	64990000	Boys Town Trading Store / Rewards for students	\$61.34
2021-05-10	SQ *APE SPORTS, INC.	63910000	Vinyl Mat for Students in Crisis	\$298.80
2021-05-10	USPS PO 4801500411	64980000	Certified Mail for Parents & Students	\$4.20
2021-05-11	USPS PO 4801500411	64980000	Certified Mail for Parents & Students	\$4.20
2021-05-13	AMAZON.COM*2L1M85VK2	63990000	Supplies for the Nurse	\$45.50
2021-05-13	USPS PO 4801500411	64980000	Certified Mail for Parents & Students	\$39.05
2021-05-13	AMZN MKTP US*2L72I7IE1	63990000	Supplies for the nurse	\$16.44
2021-05-14	WM SUPERCENTER #3296	64990000	Boys Town Trading Store for students	\$12.96
2021-05-14	WM SUPERCENTER #3296	64990000	Boys Town Trading Store / Rewards for students	\$514.11
2021-05-14	WM SUPERCENTER #3296	64990000	ABS West Graduation Supplies	\$56.97
2021-05-14	WAL-MART #3296	63990000	General Supplies	\$37.82
2021-05-14	USPS PO 4803720060	64980000	Certified Mail for Parents & Students	\$10.20
2021-05-15	SAMS CLUB #8245	64990000	Boys Town Trading Store / Rewards for students	\$70.82
2021-05-17	USPS PO 4801500411	64980000	Certified Mail for Parents & Students	\$12.85
2021-05-17	OFFICE DEPOT #3312	63990000	General Supplies for Dr. Keys and Administration	\$107.98
2021-05-18	USPS PO 4801500411	64980000	Certified Mail for Parents & Students	\$4.20
2021-05-18	USPS PO 4801500411	64980000	Certified Mail for Parents & Students	\$8.40
2021-05-19	WM SUPERCENTER #3296	63980000	Food for Classroom	\$16.75
2021-05-19	WM SUPERCENTER #3296	64990000	ABS West Graduation Supplies	\$138.05



## HCDE Procurement Card Report - June Statement

### 132 - ABC West

2021-05-19	WAL-MART #3296	64990000	Boys Town Trading Store / Rewards for students	\$62.69
2021-05-19	USPS PO 4803720060	64980000	Certified Mail for students	\$4.20
2021-05-21	CHEVRON 0357737	63110000	Gas Fuel for the Bus	\$75.00
2021-05-21	USPS PO 4801500411	64980000	Certified Mail for Parents & Students	\$6.30
2021-05-21	SQ *SHOWCASE AWARDS AN	64990000	4th Annual HCDE Chess Tournament Awards	\$192.75
2021-05-22	USPS PO 4801850044	64980000	Certified Mail for Parents & Students	\$19.79
2021-05-24	CHEVRON 0359221	63110000	ABS West Fuel for Bus	\$110.01
2021-05-24	LUBYS CAFE #0032 Q99	64990004	ABS West Boys Town Merit/Seniors Field Trip	\$296.53
2021-05-24	USPS PO 4801500411	64980000	Certified Mail for Parents & Students	\$4.20
2021-05-24	USPS PO 4803720060	64980000	Certified Mail for Parents & Students	\$2.10
2021-05-25	KALAHARI RESORT - TX -	64110000	TASBO Certification - Hotel for Denise Alamos	\$243.99
2021-05-25	KALAHARI RESORT - TX -	64110000	TASBO Certification - Hotel for Alma Ochoa	\$243.99
2021-05-25	SAMS CLUB #4769	64990000	Boys Town Trading Store / Rewards for students	\$265.61
2021-05-25	SAMS CLUB #4769	64990000	Boys Town Trading Store / Rewards for Students	\$106.72
2021-05-25	SAMS CLUB #4769	64990000	Boys Town Trading Store / Rewards for students	\$135.70
2021-05-25	SAMSCLUB #4769	64990000	Boys Town Trading Store/ Rewards for students	\$267.13
2021-05-25	SAMSCLUB #4769	63990000	General Supplies	\$102.65
2021-05-25	TASBO	64140000	Alma Ochoa TASBO Registration	\$645.00
2021-05-25	USPS PO 4801500411	64980000	Certified Mail for Parents & Students	\$11.10
2021-05-26	USPS PO 4801500411	64980000	Certified Mail for Parents & Students	\$48.20
2021-05-27	WM SUPERCENTER #3296	63990000	General Supplies for the Domestic Lab	\$35.99
2021-05-27	USPS PO 4801500411	64980000	Certified Mail for Parents & Students	\$4.40
2021-05-28	CI CIS #835	64990000	4th Annual HCDE Chess Tournament	\$508.35
2021-05-28	USPS PO 4801500411	64980000	Certified Mail for Parents & Students	\$9.46
2021-05-28	THE GRADUATION STORE	64990000	Gold 2021 Tassels items for the graduation	\$72.00
2021-05-28	LIBERTY DATA PRODUCTS	63990000	General Supplies for Administration Staff	\$231.25
2021-05-31	WM SUPERCENTER #2257	64990000	Rewards for Students	\$90.91
2021-06-01	SAMSCLUB #4769	63990000	General Supplies	\$30.14
2021-06-01	SAMS CLUB #4769	64160000	Graduation ABS-West	\$44.82
2021-06-01	SAMS CLUB #4769	63980000	Food for Classrooms	\$126.67
2021-06-01	AQUARIUM - HOUSTON AMU	64990004	Earth Day Field Trip	\$110.00
2021-06-01	AQUARIUM - HOUSTON AMU	64990004	Earth Day Field Trip	\$29.90
2021-06-02	OFFICE DEPOT #2195	63990000	General Supplies for the Staff	\$112.95
2021-06-02	USPS PO 4801500411	64980000	Certified Mail for Parents & Students	\$11.35

# HCDE Procurement Card Report - June Statement

---

## 132 - ABC West

2021-06-03	USPS PO 4801500411	64980000	Certified Mail for Parents & Students	\$21.75
------------	--------------------	----------	---------------------------------------	---------

---

**132 - ABC West**      **\$7,891.50**

## 190 - Technology Cloud Project

2021-05-06	TST* NOTHING BUNDT CAK	64990000	Teacher Appreciation Misc.	\$648.00
2021-06-02	ADOBE *800-833-6687	63970000	Adobe ID account login - Access Adobe Products	\$9.99

---

**190 - Technology Cloud Project**      **\$657.99**

## HCDE Procurement Card Report - June Statement

### 201 - Adult Education

2021-05-10	CENTRAL SUSQUEHANNA IN	64140000	Reg. fees for DJohnson to attend SEL&Equity Conf.	\$399.00
2021-05-10	CENTRAL SUSQUEHANNA IN	64140000	Reg. fees for CMagallan to attend SEL&Equity Conf.	\$399.00
2021-05-10	CENTRAL SUSQUEHANNA IN	64140000	Reg. fees for BBentley to attend SEL&Equity Conf.	\$399.00
2021-05-10	CENTRAL SUSQUEHANNA IN	64140000	Reg. fees for MO'Brien to attend SEL&Equity Conf.	\$399.00
2021-05-10	CENTRAL SUSQUEHANNA IN	64140000	Reg. fees for GMedina to attend SEL&Equity Conf.	\$399.00
2021-05-11	AIR	64140000	Reg. fees for GMedina to attend AIR Forum	\$549.00
2021-05-11	CENTRAL SUSQUEHANNA IN	64140000	Reg. fees for ADeLeon to attend SEL&Equity Conf.	\$399.00
2021-05-11	JASON'S DELI TNY 028	64180000	Refreshments for Ops Meeting	\$130.33
2021-05-13	AIR	64140000	Reg. fee for ADeLeon to attend the AIR Conf.	\$549.00
2021-05-13	AIR	64140000	Reg. fee for DBreaux to attend the AIR Conf.	\$549.00
2021-05-13	AIR	64140000	Reg. fee for CMagallan to attend the AIR Conf.	\$549.00
2021-05-13	AIR	64140000	Reg. fee for MO'Brien to attend the AIR Conf.	\$549.00
2021-05-14	UNITED 01623483843730	64130000	Transp. for BBentley to attend the CECU Convention	\$284.42
2021-05-14	UNITED 01623483853375	64130000	Transp. for CMagallan - attend the CECU Convention	\$284.42
2021-05-14	UNITED 01623483859756	64130000	Transp. for LFehoko to attend the CECU Convention	\$284.42
2021-05-14	UNITED 01623483866056	64130000	Transp. for MO'Brien to attend the CECU Convention	\$284.42
2021-05-14	UNITED 01623483873244	64130000	Transp. for SRoss to attend the CECU Convention	\$284.42
2021-05-15	EXTRA SPACE 0521	62680000	Storage for AED furniture and materials	\$110.50
2021-05-25	CAREER EDUCAT	64140000	Reg. Fees to attend the Career Ed Convention	\$3,600.00
2021-05-25	CAREER EDUCAT	64140000	Reg. fees to attend Career Ed Convention (Ops)	\$3,600.00
2021-05-25	NTLREST SERVSAFE	63970000	Software purchase for classroom use	\$1,500.00
2021-05-26	AMZN MKTP US*2R76F0122	64180000	General supplies for Division	\$35.99
2021-05-27	SOUTHWES 5262391307576	64130000	Transp. for LFehoko to attend the CECU Convention	\$518.96
2021-05-31	AMZN MKTP US*2R3R71760	64180000	General supplies for Division	\$20.98
2021-05-31	PICATA PIZZA & PASTA	64180000	Refreshments for OPS Meeting	\$41.76
2021-06-04	SOUTHWES 5269890977346	64130000	Refund for for LFehoko to attend CECU Conv.	(\$112.01)

**201 - Adult Education      \$16,007.61**

## HCDE Procurement Card Report - June Statement

### 301 - ISS-Division Wide

2021-05-07	LINKEDIN-564*9277196	64990000	Subscription renewal for ads.	\$64.94
2021-05-08	ADOBE ACROPRO SUBS	63970000	Acrobat Pro for Internet Editing on Laptop.	\$14.99
2021-05-10	AMAZON.COM*2L5AO3DC1	63990000	Office supply - Ink for Printer	\$60.63
2021-05-11	4IMPRINT	63990000	Materials for Ron Clark's workshop	\$866.19
2021-05-12	IN *J.COLE PRODUCTIONS	63960000	Printing of Flyers for workshops.	\$125.00
2021-05-12	POST OAK TROPHIES AND	64990000	Crystal glass awards for Ron Clark's event	\$45.00
2021-05-13	ZOOM.US 888-799-9666	64990000	Zoom subscription for meeting	\$134.97
2021-05-18	AMAZON.COM*2L7M11W40	63290000	Split - Books for TLC curriculum director (91.26%)	\$119.59
2021-05-18	AMAZON.COM*2L7M11W40	63990000	Split - Office Supplies - Post-it Notes (8.74%)	\$11.46
2021-05-18	AMZN MKTP US*2L8WW6WIO	63290000	Books for TLC curriculum director	\$156.80
2021-05-20	LINKEDIN-569*1372706	64990000	Sales Tax Refund for LinkedIn Order 5321017076	(\$4.95)
2021-05-20	LINKEDIN-569*1369826	64990000	Sales Tax Refund for LinkedIn Order 5649277196	(\$4.95)
2021-05-20	LINKEDIN 5417234066	64990000	Sales Tax Refund for LinkedIn Order 5417234066	(\$4.95)
2021-05-20	LINKEDIN 5512404586	64990000	Sales Tax Refund for LinkedIn Order 5512404586	(\$4.95)
2021-05-25	LINKEDIN-570*9244936	64990000	Subscription renewal for event advertising.	\$59.99
2021-05-26	BLUESKY APPS	64990000	Zoom Meeting attendance apps/graphics	\$19.99
2021-05-26	LA MADELEINE SAWYER HE	64150000	Lunch provided for TLC interview panelist.	\$252.00
2021-05-26	LA MADELEINE SAWYER HE	64180000	Breakfast provided for TLC interview panelist.	\$132.00
2021-05-27	JASON'S DELI TNY 028	64150000	Breakfast-TLC Senior Director Interview Committee	\$120.51
2021-05-28	ALONTI CAFE & CATERING	64150000	Lunch-TLC Senior Director Interview Committee	\$92.70
2021-05-28	ZOOM.US 888-799-9666	64990000	Zoom - Add on storage	\$51.61
2021-06-01	IN *J.COLE PRODUCTIONS	63960000	Printing of Flyer for leadership matters workshop.	\$265.00
2021-06-02	CALENDLY	64990000	Monthly charge for appt. booking calendar	\$15.00
2021-06-02	GRAMMARLY COROJ1KI3	64990000	Subscription for editing/grammar app	\$59.95
2021-06-02	AMAZON.COM*2R57L3YA0	63290000	Books for curriculum director - Bootcamp planning	\$92.31

**301 - ISS-Division Wide      \$2,740.83**

### 302 - ISS-Math

2021-05-12	KROGER #312	64180000	Refreshments Spring Lead. academy Tutoring session	\$70.88
2021-05-13	SHIPLEY YALE	64180000	Refreshments Spring Lead. academy Tutoring session	\$30.28
2021-05-19	NATL CCL TEACHERS OF M	64970000	Membership Dues Nat. Council Teachers of Math	\$149.00
2021-05-25	OFFICE DEPOT #2809	63990000	Office supplies Math Director	\$34.79

**302 - ISS-Math      \$284.95**

## HCDE Procurement Card Report - June Statement

### 307 - ISS-English Language Arts

2021-05-06	SP * OUISI PHOTO GAME	63990000	Office supplies - Visual cards for workshops	\$39.95
2021-05-06	AMAZON.COM*IP3UY28S3	63990000	Office Supplies - cardboard boxes	\$69.72
2021-05-06	AMAZON.COM*Q44OL8XQ3	63290000	Books for TLC ELA/SS curriculum director.	\$47.35
2021-05-08	AMZN MKTP US*2L5FX3TU0	63990000	Workshop supplies	\$163.57
2021-05-09	AMZN MKTP US*2L2685E40	63990000	Office supplies - black bubble mailers	\$33.86
2021-05-09	AMZN MKTP US*0930A7Q13	64990000	Workshop supplies - insect bugs figure toys	\$10.99
2021-05-12	BUTLER BUSINESS PRODUC	63990000	Office Supplies - Toner, Sticky Pads, Index Cards	\$440.63
2021-05-13	BUTLER BUSINESS PRODUC	63990000	Office Monthly Planner	\$25.07
2021-05-13	BUTLER BUSINESS PRODUC	63990000	Batteries, Black Toner	\$69.64
2021-05-13	AMAZON.COM*2L5L72HK0	63290000	Books for TLC ELA/SS curriculum director.	\$58.78
2021-05-14	BITLY.COM	64990000	Refund/Credit for cancelled service.	(\$32.34)
2021-05-17	WWW.STENHOUSE.COM	63290000	Books for TLC ELA/SS curriculum director.	\$34.64
2021-05-17	AMAZON.COM*2L9IK99G0	63990000	Office supplies - Ink cartridges	\$54.89
2021-05-20	AMZN MKTP US*2L6AI3WG2	63290000	Books for TLC ELA/SS curriculum director.	\$49.94
2021-05-20	AMAZON.COM*2R6QK8OK0	63290000	Books for TLC ELA/SS curriculum director.	\$47.84
2021-05-24	REI*GREENWOODHEINEMAN N	63290000	Heinemann books for TLC ELA/SS curriculum director	\$46.00
2021-05-25	AMZN MKTP US*2R5QA2S01	63990000	Office supplies - USB cable	\$8.97
2021-05-28	AMZN MKTP US*2R0P85M72	63990000	Office supplies - black bubble mailers.	\$17.93
2021-05-29	ZOOM.US 888-799-9666	64990000	Monthly active subscription for TLC workshops	\$54.99
2021-06-01	ZOOM.US 888-799-9666	64990000	Monthly active subscription for TLC workshops.	\$40.00
2021-06-01	AMZN MKTP US*2X6GU1EL1	63990000	Office supplies - iPhone charger/cable pack of 5	\$13.99
2021-06-02	SP * SHARON MCMAHON ED	64990000	Subscription for TLC workshop.	\$79.00
2021-06-02	AMZN MKTP US*2R7Y307P2	63990000	Office supplies - brown wrapping paper roll	\$20.99
2021-06-04	FLOWCODE	64990000	Active subscription for TLC workshop.	\$4.95

**307 - ISS-English Language Arts      \$1,401.35**

### 312 - Scholastic Arts Program

2021-05-05	USPS PO 4801740017	64980000	Mail out for TLC	\$71.24
2021-05-05	USPS PO 4801740017	64980000	Mailout for TLC	\$206.10
2021-05-05	USPS PO 4801740017	64980000	Mailout for TLC	\$47.04
2021-05-05	USPS PO 4801740017	64980000	Postage for TLC	\$312.80
2021-06-01	PAYPAL *ABYERS	64990000	Misc. Operating costs Virtual Writing Exhibit	\$600.00
2021-06-01	PAYPAL *ABYERS	64990000	Misc. Operating costs Virtual Art Exhibit	\$600.00

**312 - Scholastic Arts Program      \$1,837.18**

## HCDE Procurement Card Report - June Statement

---

### 313 - ISS-Special Education

2021-05-12	HOBBY-LOBBY #0110	63990000	Office Supplies for SLA workshops.	\$22.01
------------	-------------------	----------	------------------------------------	---------

---

<b>313 - ISS-Special Education</b>	<b>\$22.01</b>
------------------------------------	----------------

### 314 - ISS-Speaker Series

2021-06-01	LINKEDIN 6678374884	64990000	Leadership Marketing - Sales Navigator Prof.	\$85.27
------------	---------------------	----------	--	---------

2021-06-02	AMAZON.COM*2X43D81V1	63290000	Reading Materials YA book club educators	\$6.25
------------	----------------------	----------	--	--------

2021-06-03	AMAZON.COM*2R8BV7IS2	63290000	Reading materials HISD School of Choice Cohort	\$14.99
------------	----------------------	----------	--	---------

2021-06-04	AMAZON.COM*2X0LY6VU1	63290000	Reading Materials HISD school of Choice Cohort	\$224.85
------------	----------------------	----------	--	----------

---

<b>314 - ISS-Speaker Series</b>	<b>\$331.36</b>
---------------------------------	-----------------

## HCDE Procurement Card Report - June Statement

### 501 - Special Schools

2021-05-07	SQ *SOUTHERN STYLE SEA	64150000	Business Meeting	\$540.00
2021-05-08	RANDYS SMOKEHOUSE &BBQ	64150000	Meals-Highpoint School East	
			Expenses for Business Meeting	\$570.00
2021-05-08	RANDYS SMOKEHOUSE &BBQ	64150000	Meals-Fortis Academy	
			Expenses for Business Meeting	\$677.50
2021-05-08	RANDYS SMOKEHOUSE &BBQ	64150000	Meals-ABS West	
			Expenses for Business Meeting	\$652.50
2021-05-14	AMZN MKTP US*2L5OZ6680	63990000	Meals-ABS East	
			Expenses for General Supplies and Materials-Alamos	\$125.95
2021-05-14	IN *COLOR ONE SYSTEMS,	63960000	Printing expenses for Schools Division	\$70.00
2021-05-14	THINGS REMEMBERED 0452	64990000	Expenses for Materials-Administrators	\$258.00
2021-05-14	ARNE'S	64990000	Expenses for Teacher of the Year	\$15.60
2021-05-16	AMZN MKTP US*2L8G57KB0	63990000	Expenses for General Supplies and Materials-Alamos	\$27.00
2021-05-17	H-E-B #028	64990000	Expenses for Teacher of the Year	\$24.99
2021-05-18	GABBYS BBQ - HOUSTON	64150000	Expenses for Business Meeting	\$99.47
2021-05-21	4IMPRINT	63990000	Meals-Schools	
			Expenses for general office supplies	\$375.32
2021-05-24	AMZN MKTP US*2R8KU9E00	63990000	Expenses for General Supplies & Materials-Mullins	\$7.99
2021-05-25	BUTLER BUSINESS PRODUC	63990000	General expenses for office supplies	\$52.38
2021-05-25	TASBO	64940000	Registration for Denise Alamos to attend TASBO.	\$645.00
2021-05-25	AMZN MKTP US*2R8GD2PN0	63990000	Expenses for General Supplies & Materials-Mullins	\$143.21
2021-05-26	CHICK-FIL-A #02820	64150000	Expenses for Business Meeting	\$80.19
			Meals-Administrative	
2021-05-26	PAPPAS BAR-B-Q #061Q80	64150000	Expenses for Principal's Interview	\$160.95
2021-05-27	AMZN MKTP US*2R0LU0H90	63990000	Expenses for office supplies	\$294.95
2021-05-27	01439-CLBCRP SC-CCCM	64990000	Expenses for Staff	\$366.00
			Development-Administation	
2021-05-30	AMZN MKTP US*2X3UI8NS1	63990000	General office supplies	\$93.97
2021-06-03	REGION 4 EDUCATION SER	64940000	Registration for Michelle Rayson, Region 4 AEL	\$450.00
2021-06-03	REGION 4 EDUCATION SER	64940000	Registration for Michelle Rayson, Region 4 T-TESS	\$450.00
2021-06-06	AMZN MKTP US*2X7RK94E2	63990000	Split - Expenses for general office expenses (8.22%)	\$63.92
2021-06-06	AMZN MKTP US*2X7RK94E2	63290000	Split - Expenses for staff development (91.78%)	\$713.24
			<b>501 - Special Schools</b>	<b>\$6,958.13</b>

## HCDE Procurement Card Report - June Statement

### 800 - Fortis Academy

2021-05-05	DOLLARTREE	63990000	Fees for Office Supplies	\$7.00
2021-05-05	JOE V'S #616	63910000	Fees for Instructional Supplies (Culinary Class)	\$13.34
2021-05-06	LITTLE CAESARS 4578	63410000	Fees for Student's Lunches	\$35.00
2021-05-10	WENDY'S 25	63410000	Fees for Cafeteria Lunches (Student's)	\$45.00
2021-05-11	SUBWAY 2387	63410000	Fees for Student's Lunches	\$79.98
2021-05-12	SAMSCLUB #8245	63410000	Fees for Student's Lunches	\$28.60
2021-05-12	SAMS CLUB #8245	63410000	Fees for Student's Lunches	\$15.36
2021-05-13	JOE V'S #616	63910000	Fees for Instructional Supplies (Culinary Class)	\$6.70
2021-05-14	SAMSCLUB #8245	63410000	Credit Due to Taxes were Charged.	(\$58.33)
2021-05-14	AMAZON.COM*2L4TQ95S2	63990000	Fees for Office Supplies	\$46.10
2021-05-14	SAMS CLUB #8245	63410000	Fees for Student's Lunches	\$58.33
2021-05-14	SAMSCLUB #8245	63410000	Fees for Student's Lunches	\$53.88
2021-05-14	SAMSCLUB #8245	63410000	Fees for Student's Cafeteria Breakfast & Lunches	\$168.57
2021-05-14	TACO CABANA 20241	63410000	Fees for Cafeteria Student's Breakfast	\$27.98
2021-05-17	SAMS CLUB #8245	64990000	Fees for Teacher's Appreciation Day	\$15.98
2021-05-17	POPEYES 11105	63410000	Fees for Student's Lunches	\$67.98
2021-05-18	SAMS CLUB #8245	63410000	Fees for Cafeteria Student's Breakfast	\$105.94
2021-05-18	EL RANCHO # 31	63910000	Fees for Instructional Supplies (Culinary Class)	\$34.93
2021-05-21	LITTLE CAESARS 4578	63410000	Fees for Student's Lunches	\$35.00
2021-05-25	WAL-MART #4416	64990000	General supplies for students	\$24.92
2021-05-26	SAMSCLUB #8245	63410000	Fees for Student's Breakfast	\$92.92
2021-05-26	SAMS CLUB #8245	63410000	Fees for Student's Lunches	\$20.80
2021-05-27	ARNE'S	63990000	Fees for Office Supplies	\$34.89
2021-05-28	LITTLE CAESARS 4578	63410000	Fees for Student's Lunches	\$40.00
2021-05-28	WM SUPERCENTER #1279	63990000	Fees for Office Supplies	\$12.70
2021-06-01	SAMS CLUB #8245	64160000	Fees for Graduation Ceremony	\$32.28
2021-06-01	WM SUPERCENTER #1279	63990000	Fees for Office Supplies	\$1.97
2021-06-02	SQ *BALLOONIZEYOUREVEN	64990000	Graduation expenses for Fortis graduate	\$265.00
2021-06-03	LA MADELEINE CHAMPIONS	64160000	Fees for Graduation Ceremony Food	\$605.00
2021-06-03	TACO CABANA 20241	63410000	Fees for Student's Cafeteria Breakfast	\$41.97
2021-06-04	AMZN MKTP US*2R6NC9W42	63990006	Split - Laptop Screen (78.81%)	\$93.00
2021-06-04	AMZN MKTP US*2R6NC9W42	63990006	Split - Shpping (21.19%)	\$25.00
<b>800 - Fortis Academy</b>				<b>\$2,077.79</b>



## HCDE Procurement Card Report - June Statement

### 901 - Head Start

2021-05-05	THE HOME DEPOT #6806	63190000	Split - Maintenance Supplies - Tidwell (31.97%)	\$26.98
2021-05-05	EXXONMOBIL 48054464	63110000	Split - Fuel for HS courier vehicle (70%)	\$26.33
2021-05-05	EXXONMOBIL 48054464	63110000	Split - Fuel for EHS courier vehicle (30%)	\$11.28
2021-05-06	THE HOME DEPOT #6806	63190000	Maintenance supplies - Tidwell	\$6.44
2021-05-06	BUC-EE'S #34	63110000	Split - Fuel for HS courier vehicle (70%)	\$31.18
2021-05-06	BUC-EE'S #34	63110000	Split - Fuel for EHS courier vehicle (30%)	\$13.36
2021-05-06	WM SUPERCENTER #4526	64990000	Split - Supplies for Mental Wellness project HS St (90%)	\$10.48
2021-05-06	WM SUPERCENTER #4526	64990000	Split - Supplies for Mental Wellness project EHS (10%)	\$1.16
2021-05-06	OFFICE DEPOT #2809	64990000	Split - Supplies for Mental Wellness project HS St (90%)	\$25.85
2021-05-06	OFFICE DEPOT #2809	64990000	Split - Supplies for Mental Wellness project EHS (10%)	\$2.87
2021-05-06	TX HHSC CCL FEE	64920000	CCL background fees for Humble HS	\$122.96
2021-05-07	EXXONMOBIL 99893935	63110000	Split - Fuel for HS courier vehicle (70%)	\$24.50
2021-05-07	EXXONMOBIL 99893935	63110000	Split - Fuel for EHS courier vehicle (30%)	\$10.50
2021-05-07	OTC BRANDS INC	63910000	Kites for the SuperMentor activity for Compton HS	\$79.74
2021-05-08	IDENTOGO - TX FINGERPR	62990000	Fingerprint services for S Rodriguez	\$40.75
2021-05-11	LOWES #03362*	63940001	Tax Credit - dryer for the Tidwell EHS campus	(\$37.04)
2021-05-11	CHICK-FIL-A #02820	64150000	Meals for Healthy Minds Healthy Families Conferece	\$0.32
2021-05-11	EXXONMOBIL 48054464	63110000	Split - Fuel for HS courier vehicle (70%)	\$26.32
2021-05-11	EXXONMOBIL 48054464	63110000	Split - Fuel for EHS courier vehicle (30%)	\$11.28
2021-05-11	JOHNSON SUPPLY N SHE	63190000	Split - Maintenance supplies - Channelview (20.13%)	\$35.41
2021-05-11	LOWES #03362*	63940001	Tax Credit - washer for the Tidwell EHS campus	(\$37.04)
2021-05-12	TX HHSC CCL FEE	64920000	CCL background fees for Channelview HS	\$108.64
2021-05-12	BUC-EE'S #34	63110000	Split - Fuel for HS courier vehicle (70%)	\$22.09
2021-05-12	BUC-EE'S #34	63110000	Split - Fuel for EHS courier vehicle (30%)	\$9.47
2021-05-12	TEACHSTONE TRAINING	64940000	Pre-K, Infant/Toddler Combo CLASS Observation Trng (77.78%)	\$5,425.00
2021-05-12	TEACHSTONE TRAINING	64940000	Pre-K, Infant/Toddler Combo CLASS Observation Trng (22.22%)	\$1,550.00
2021-05-13	MESA FOOD MART	63110000	Split - Fuel for HS courier vehicle (70%)	\$32.91
2021-05-13	MESA FOOD MART	63110000	Split - Fuel for EHS courier vehicle (30%)	\$14.11

## HCDE Procurement Card Report - June Statement

### 901 - Head Start

2021-05-13	SAMS CLUB #8281	63910000	Split - (60%)	\$132.91
2021-05-13	SAMS CLUB #8281	63910000	Split - Instructional Materials Diapers (40%)	\$88.61
2021-05-13	EXXONMOBIL 48054464	63110000	Split - Fuel for HS courier vehicle (70%)	\$0.48
2021-05-13	EXXONMOBIL 48054464	63110000	Split - Fuel for EHS courier vehicle (30%)	\$0.20
2021-05-13	EXXONMOBIL 48054464	63110000	Split - Fuel for HS courier vehicle (70%)	\$0.08
2021-05-13	EXXONMOBIL 48054464	63110000	Split - Fuel for EHS courier vehicle (30%)	\$0.04
2021-05-13	WWW.PINSTRIPES.COM	62650000	Split - HS Executive Leadership Planning Meeting (80%)	\$367.50
2021-05-13	WWW.PINSTRIPES.COM	62650000	Split - EHS Executive Leadership Planning Meeting (20%)	\$91.88
2021-05-13	IDENTOGO - TX FINGERPR	62990000	Fingerprint services for I Rice	\$40.75
2021-05-13	IDENTOGO - TX FINGERPR	62990000	Fingerprint services for C Marshall	\$40.75
2021-05-14	POST OAK TROPHIES AND	64990000	Split - HS Policy Council End of the Year celebrat (88%)	\$182.16
2021-05-14	POST OAK TROPHIES AND	64990000	Split - EHS Policy Council End of the Year celebra (12%)	\$24.84
2021-05-17	JOHNSTONE SUPPLY OF HO	63190000	Return - Channelview	(\$346.64)
2021-05-17	BUC-EE'S #34	63110000	Split - Fuel for HS courier vehicle (70%)	\$31.13
2021-05-17	BUC-EE'S #34	63110000	Split - Fuel for EHS courier vehicle (30%)	\$13.34
2021-05-17	JOHNSTONE SUPPLY OF HO	63190000	Maintenance supplies - Channelview	\$346.64
2021-05-17	IDENTOGO - TX FINGERPR	62990000	Fingerprint services for B Fraley	\$40.75
2021-05-17	CITY OF BAY TOWN ALARM	64920000	False Alarm fees for Baytown HS/EHS (11%)	\$6.38
2021-05-17	CITY OF BAY TOWN ALARM	64920000	False Alarm fees for Baytown HS/EHS (89%)	\$51.62
2021-05-18	BUC-EE'S #34	63110000	Split - Fuel for HS courier vehicle (70%)	\$28.86
2021-05-18	BUC-EE'S #34	63110000	Split - Fuel for EHS courier vehicle (30%)	\$12.37
2021-05-18	IDENTOGO - TX FINGERPR	62990000	Fingerprint services for A Vongsaly	\$40.75
2021-05-19	THE HOME DEPOT #6507	63190000	Maintenance supplies - Baytown	\$18.62
2021-05-19	SAMSCLUB.COM	63410000	Emerg. water purchase 4 Tidwell's boil water order	\$15.88
2021-05-19	EXXONMOBIL 47937743	63110000	Split - Fuel for HS courier vehicle (70%)	\$29.06
2021-05-19	EXXONMOBIL 47937743	63110000	Split - Fuel for EHS courier vehicle (30%)	\$12.45
2021-05-19	WALMART.COM AA	63410000	Formula 4 a Baytown EHS student	\$107.94
2021-05-20	UNITED REFRIG BR #83	63190000	Maintenance supplies - Channelview	\$300.00
2021-05-21	UNITED REFRIG BR #83	63190000	Maintenance supplies - Baytown Head Start	\$318.76
2021-05-21	WALMART.COM AA	63410000	Credit 4 Formula 4 a Baytown EHS student	(\$35.98)
2021-05-21	SHELL OIL 57543437800	63110000	Split - Fuel for HS courier vehicle (70%)	\$28.00

## HCDE Procurement Card Report - June Statement

### 901 - Head Start

2021-05-21	SHELL OIL 57543437800	63110000	Split - Fuel for EHS courier vehicle (30%)	\$12.00
2021-05-21	LOWES #01145*	63190000	Maintenance supplies - Tidwell	\$39.02
2021-05-22	IDENTOGO - TX FINGERPR	62990000	Fingerprint services for O Grays	\$40.75
2021-05-23	SAMSCLUB.COM	63910000	Split - Instructional Materials Diapers (60%)	\$723.56
2021-05-23	SAMSCLUB.COM	63910000	Split - Instructional Materials Diapers (40%)	\$482.38
2021-05-25	THE HOME DEPOT #0569	63190000	Maintenance supplies - Channelview	\$75.88
2021-05-25	THE HOME DEPOT #0569	63190000	Maintenance supplies - Sheffield	\$75.88
2021-05-25	WWW.PINSTRIPES.COM	62650000	Split - HS Executive Leadership Planning Meeting (80%)	\$367.50
2021-05-25	WWW.PINSTRIPES.COM	62650000	Split - EHS Executive Leadership Planning Meeting (20%)	\$91.87
2021-05-25	WALMART.COM AX	63410000	Formula 4 a Baytown EHS student	\$35.98
2021-05-25	IDENTOGO - TX FINGERPR	62990000	Fingerprint services for L Ibarra	\$40.75
2021-05-26	1529 INSCO HOUSTON	63190000	Maintenance supplies - Baytown	\$71.25
2021-05-26	HOBBY-LOBBY #895	63990000	Journals used @ the Executive Ldrship Planning Mtg (50%)	\$64.70
2021-05-26	HOBBY-LOBBY #895	63990000	Journals used @ the Executive Ldrship Planning Mtg (50%)	\$64.70
2021-05-26	PAYPAL *ANAIAEVENTS	64990000	HS/EHS End of the Yr Celebration Sweet Treat (90%)	\$864.68
2021-05-26	PAYPAL *ANAIAEVENTS	64990000	HS/EHS End of the Yr Celebration Sweet Treat (10%)	\$96.07
2021-05-26	JOHNSON SUPPLY STELLA	63190000	Maintenance supplies - Coolwood	\$427.22
2021-05-27	THE HOME DEPOT #0577	63190000	Maintenance supplies - Coolwood	\$552.85
2021-05-27	BUC-EE'S #34	63110000	Split - Fuel for HS courier vehicle (70%)	\$31.39
2021-05-27	BUC-EE'S #34	63110000	Split - Fuel for EHS courier vehicle (30%)	\$13.45
2021-05-27	TIDWELL FOOD MART	63110000	Split - Fuel for HS courier vehicle (70%)	\$33.22
2021-05-27	TIDWELL FOOD MART	63110000	Split - Fuel for EHS courier vehicle (30%)	\$14.24
2021-05-27	TEACHSTONE TRAINING	64940000	Infant & Toddler CLASS Train the Trainer Course	\$7,650.00
2021-06-01	LOVES TRAVEL S00004192	63110000	Split - Fuel for HS courier vehicle (70%)	\$24.25
2021-06-01	LOVES TRAVEL S00004192	63110000	Split - Fuel for EHS courier vehicle (30%)	\$10.39
2021-06-02	HC FIRE MARSHAL	63190000	Building Maintenance - Humble HS	\$260.00
2021-06-02	JOHNSON SUPPLY PASADEN	63190000	Maintenance supplies - Baytown	\$21.10
2021-06-02	IDENTOGO - TX FINGERPR	62990000	Fingerprint services for T Houston	\$40.75
2021-06-03	THE FRENCH CORNER CATE	64150000	Lunch for the End of the Yr Event & Training (90%)	\$2,705.17
2021-06-03	THE FRENCH CORNER CATE	64150000	Lunch for the End of the Yr Event & Training (10%)	\$300.58
2021-06-04	PPG PAINTS 9621	63190000	Maintenance supplies - Barrett Station	\$67.24

**901 - Head Start \$24,884.80**

## HCDE Procurement Card Report - June Statement

### 922 - Coop After School Enrich (CASE)

2021-05-07	CANVA* 03048-16289182	64990000	Subscription	\$358.20
2021-05-09	CALENDLY	64990000	Monthly subscription	\$10.00
2021-05-10	EIG*CONSTANTCONTACT.C O	64990130	Monthly Subscription	\$70.00
2021-05-11	WM SUPERCENTER #3640	64990000	Snacks for the Women's Conference	\$103.15
2021-05-12	AMZN MKTP US*2L42D67Q1	63990000	Microphone adapter for podcast	\$15.94
2021-05-14	PANERA BREAD #204111 P	64150000	County connections grant review meeting	(\$75.62)
2021-05-14	PANERA BREAD #204111 P	64150000	County connections grant review meeting	(\$5.40)
2021-05-14	PANERA BREAD #204111 O	64150000	County connections grant review meeting	\$179.32
2021-05-15	PANERA BREAD #204111 O	64150000	County connections grant review meeting	\$604.16
2021-05-17	DEMERIS BARBECUE - SHE	64150000	County connections grant review meeting	\$545.00
2021-05-19	SAMSClub.COM	64990130	Snacks for Drone competition	\$378.56
2021-05-20	AMAZON.COM*2R6F79G21	64990130	Labels	\$42.56
2021-05-20	AMZN MKTP US*2R3WQ24Z0	64990130	Labels	\$28.28
2021-05-20	WM SUPERCENTER #3640	64990130	Lunch Bags	\$3.92
2021-05-21	WM SUPERCENTER #744	64990130	Water	\$17.68
2021-05-21	TIA MARIA MEXICAN REST	64150000	County connections grant review meeting	\$91.04
2021-05-28	WM SUPERCENTER #3640	63990050	office supplies	\$66.62
2021-05-28	TEXAS NETWORK OF YOUTH	64190007	CONFERENCE REGISTRATION FOR TNOYS	\$2,530.00
2021-06-02	MARKETING MAGIC INTERN	64990130	Awards	\$43.60
2021-06-03	SAMSClub #4712	64990130	Snacks for Summer Camp	\$95.52
2021-06-03	SQ *STATION THEATER (A	64940000	Training Facilitation for CASE for Kids event	\$1,000.00
2021-06-04	DEMERIS BARBECUE - SHE	64150000	Retreat lunch for staff	\$1,077.35

**922 - Coop After School Enrich (CASE) \$7,179.88**

### 923 - Resource Development

2021-05-06	EIG*CONSTANTCONTACT.C O	63970000	yearly subscription to constant contact	\$539.00
2021-05-21	ZOOM.US 888-799-9666	63970000	yearly zoom subscription	\$149.90

**923 - Resource Development \$688.90**

### 924 - Research & Evaluation

2021-05-23	AMZN MKTP US*2R4Q30B21	63990000	Bluetooth headphones for staff (4)	\$279.96
2021-05-24	AMZN MKTP US*2R4K57AG0	63990000	Bluetooth headphones (1)	\$95.00
2021-05-25	AMZN MKTP US*2R1ZM3JF2	63990000	Bluetooth adapters for headphones (5)	\$39.80
2021-06-02	AMERICAN EDUCATIONAL R	64940000	AERA workshop for Dr. Yi Ren	\$55.00
2021-06-04	PIZZA HUT #27127	64150000	Staff meeting lunch	\$42.23

**924 - Research & Evaluation \$511.99**

## HCDE Procurement Card Report - June Statement

### 925 - Communications & Public Information

2021-05-19	PRINTFINISH	63990000	Clear Poly Covers for binding-HCDE	\$100.47
2021-05-29	HOUSTON CHRONICLE CIRC	63290000	Houston Chronicle For Office usage-Lorena Cozzari	\$16.00
2021-06-03	USPS PO 4801740017	64980000	Postage: to Fix video camera Lens	\$11.95

**925 - Communications & Public Information** **\$128.42**

### 955 - Purchasing - Gulf Coast Co-op

2021-05-04	KALAHARI RESORT - TX -	64110000	TASBO 2021 Summer Conference- Emily Maldonado	\$189.00
2021-05-07	TASBO	64940000	TASBO Course Registration-E. Maldonado	\$175.00
2021-05-18	AMERICAN COMMODITY DIS	64140000	ACDA 2021 Virt. Conf Registration-M Wilder	\$249.00
2021-05-19	SCHOOL NUTRITION ASSOC	64140000	SNA Conference Registration-Food Co-op - TP/MW	\$438.00
2021-05-20	IN *COLOR ONE SYSTEMS,	63960000	CP Food Flyer for Marketing	\$61.93
2021-05-21	SCHOOL NUTRITION ASSOC	64140000	2x SNA Conf. Registration- L. Sprehe& E. Maldonado	\$618.00
2021-05-24	AMZN MKTP US*2R8G176L1	63990000	Office Supplies-Food Co-op	\$63.93

**955 - Purchasing - Gulf Coast Co-op** **\$1,794.86**

### 970 - Highpoint East

2021-05-11	EXXONMOBIL 48250229	63110000	has for HCDE van	\$72.00
2021-05-11	AMZN MKTP US*2L2DY3XJ0	63990000	face mask	\$67.75
2021-05-12	WM SUPERCENTER #3500	63980000	refund for taxes charged	(\$20.55)
2021-05-12	WAL-MART #3500	63980000	student incentives	\$40.04
2021-05-12	WAL-MART #3500	63980000	student incentives	\$18.98
2021-05-14	CHICK-FIL-A #02418	63980000	student lunches	\$52.92
2021-05-14	CHICK-FIL-A #02418	63980000	student lunches	\$82.77
2021-05-22	OLIVE GARDEN 0021850	64150000	admin meeting	\$66.72
2021-05-30	WWW.QUESTIONPRO.COM	64970000	counselor testing tool	\$129.00
2021-06-01	SAMSCLUB #8281	63980000	student incentives	\$180.15
2021-06-02	PARTY CITY 786	64950000	Retirement	\$188.19
2021-06-02	WAL-MART #3500	64990000	Split - student project supplies (26.71%)	\$14.08
2021-06-02	WAL-MART #3500	63980000	Split - student incentives (73.29%)	\$38.64
2021-06-03	SAMS CLUB #8281	63980000	student incentive	\$19.98
2021-06-03	AMZN MKTP US*2R24Y5Y70	64950000	retirement	\$73.89

**970 - Highpoint East** **\$1,024.56**

**Grand Total:**

**Total transactions: 690** **\$143,195.19**

## HCDE Other Credit Card Statements

June 2021

### SUMMARY

Card	# of Cards	Total
ExxonMobil	7	\$ 3,358.61
Chevron/Texaco	1	
<b>Total</b>		<b>\$ 3,358.61</b>

### Vendor Card : ExxonMobil

#### HCDE Credit Card Report - June 2021 Statement

Cards assigned to: Facilities Division

Card #	Date	Description	Division	Amount
0017 Irvington	4/30/2021	Gasoline	Facilities	43.00
0017 Irvington	5/3/2021	Gasoline	Facilities	32.00
0017 Irvington	5/6/2021	Gasoline	Facilities	44.50
0017 Irvington	5/7/2021	Gasoline	Facilities	74.07
0017 Irvington	5/10/2021	Gasoline	Facilities	77.86
0017 Irvington	5/11/2021	Gasoline	Facilities	73.55
0017 Irvington	5/13/2021	Gasoline	Facilities	46.00
0017 Irvington	5/18/2021	Gasoline	Facilities	63.02
0017 Irvington	5/18/2021	Gasoline	Facilities	33.00
0017 Irvington	5/18/2021	Gasoline	Facilities	46.51
0017 Irvington	5/18/2021	Gasoline	Facilities	80.49
0017 Irvington	5/24/2021	Gasoline	Facilities	48.45
0017 Irvington	5/25/2021	Gasoline	Facilities	52.82
0017 Irvington	5/25/2021	Gasoline	Facilities	31.01
0018 Irvington	5/25/2021	Gasoline	Facilities	70.47
0017 Irvington	5/26/2021	Gasoline	Facilities	75.26
0017 Irvington	5/26/2021	Gasoline	Facilities	82.54
0017 Irvington	5/27/2021	Gasoline	Facilities	51.00
0017 Irvington	5/28/2021	Gasoline	Facilities	33.01
0018 Post Oak	5/5/2021	Gasoline	Facilities	42.54
0018 Post Oak	5/14/2021	Gasoline	Facilities	49.75
0020 Post Oak	4/30/2021	Gasoline	Facilities	65.75
0020 Post Oak	5/3/2021	Gasoline	Facilities	58.56
0020 Post Oak	5/11/2021	Gasoline	Facilities	70.63
0020 Post Oak	5/11/2021	Gasoline	Facilities	61.94
0020 Post Oak	5/11/2021	Gasoline	Facilities	52.01
0020 Post Oak	5/13/2021	Gasoline	Facilities	69.31
0020 Post Oak	5/17/2021	Gasoline	Facilities	75.51
0020 Post Oak	5/26/2021	Gasoline	Facilities	74.66
0022 Post Oak	5/4/2021	Gasoline	Facilities	55.91

0022 Post Oak	5/4/2021	Gasoline	Facilities	57.63
0023 Post Oak	5/4/2021	Gasoline	Facilities	45.51
0022 Post Oak	5/10/2021	Gasoline	Facilities	72.10
0022 Post Oak	5/11/2021	Gasoline	Facilities	72.11
0022 Post Oak	5/12/2021	Gasoline	Facilities	0.05
0022 Post Oak	5/12/2021	Gasoline	Facilities	0.14
0022 Post Oak	5/12/2021	Gasoline	Facilities	83.00
0022 Post Oak	5/13/2021	Gasoline	Facilities	74.47
0022 Post Oak	5/17/2021	Gasoline	Facilities	108.38
0022 Post Oak	5/19/2021	Gasoline	Facilities	56.05
0022 Post Oak	5/20/2021	Gasoline	Facilities	134.30
0022 Post Oak	5/25/2021	Gasoline	Facilities	54.88
0022 Post Oak	5/26/2021	Gasoline	Facilities	103.91
0022 Post Oak	5/28/2021	Gasoline	Facilities	62.63
0023 Post Oak	5/18/2021	Gasoline	Facilities	65.28
0024 Post Oak	5/4/2021	Gasoline	Facilities	53.05
0025 Post Oak	5/4/2021	Gasoline	Facilities	112.04
0025 Post Oak	5/7/2021	Gasoline	Facilities	61.39
0025 Post Oak	5/11/2021	Gasoline	Facilities	33.73
0025 Post Oak	5/17/2021	Gasoline	Facilities	53.83
0025 Post Oak	5/17/2021	Gasoline	Facilities	63.57
0025 Post Oak	5/17/2021	Gasoline	Facilities	60.33
0025 Post Oak	5/20/2021	Gasoline	Facilities	68.15
0025 Post Oak	5/21/2021	Gasoline	Facilities	61.30
0025 Post Oak	5/27/2021	Gasoline	Facilities	63.94
0025 Post Oak	5/28/2021	Gasoline	Facilities	65.75
			Credits	
			Rebates	-64.04
			<b>Total</b>	<b>\$ 3,358.61</b>

**Allocation after rebate**

		Rebates		
Gas Facilities	\$ 1,797.55	33.63		1763.92
Gas Records	1,625.10	30.41		1594.69
Grant total to pay	\$ 3,422.65	64.04		3358.61



# Check Register

Fiscal Year: 21      Period: 10

**Fund: 1991 - GENERAL FUND**

<u>check number</u>	<u>check date</u>	<u>vend no</u>	<u>vendor name and item descriptions</u>	<u>amount</u>	
1516058	void	05/28/2021	88696	SIMON T BAILY INTERNATIONAL INC	-1,590.00
				PA2021-0687 BOOKS	-795.00
				PA2021-0687 BOOKS	-795.00
1516101	06/04/2021	11375	ALLIANCE FOR YOUNG ARTISTS&WRITERS	19,190.00	
				MEMBERSHIPDUES&LIC	7,379.50
				MEMBERSHIPS&LIC	11,810.50
1516102	06/04/2021	87542	ALWAYS IN SEASON, INC	16.50	
				APR21PLANT MAINTANC	
1516104	06/04/2021	13871	AT&T CORP	176.72	
				PHONE 051521-061421	48.11
				PHONE 051721-061621	128.61
1516107	06/04/2021	14893	THE BAYTOWN SUN	63.33	
				ADVERISEMENT FOR HS	
1516108	06/04/2021	16005	E FLOWERS INC	70.00	
				RETIREMENT FLORAL ARR	
1516114	06/04/2021	82495	COMCAST CORPORATION	276.60	
				INTERNET 052421-06232	132.50
				INTERNET 052121-06202	144.10
1516115	06/04/2021	86779	DAVIS VISION INC	5,542.95	
				MAY2021 COBRA VISION	54.75
				MAY2021 VISION PLAN	5,488.20
1516121	06/04/2021	88574	EXECU TEAM STAFFING	804.40	
				BUSINESS SERVICES TEMP SE	
1516131	06/04/2021	88768	MARYANN GREMILLION	7,250.00	
				PROVIDE ONLINE INSTRUCTIO	3,250.00
				PROVIDE ONLINE AND VIRTUA	4,000.00
1516132	06/04/2021	29680	HARRIS COUNTY APPRAISAL DISTRICT	45,702.00	
				PA2021-0691 DIFFERENC	977.00
				Q1 - Q3 QUARTERLY ASSESSM	44,725.00
1516134	06/04/2021	88722	HIGH POINT	28,932.31	
				SSS THREADED SWIVEL HOLDE	120.40
				C INTERFOLD HAND SANITIZE	1,463.40
				SSS DISINFECTANT DEOD 12/	295.20
				LYSOL DISINF WIPES FLATPA	262.40
				BW ECO TISSUE / TM1616S-C	2,212.50
				SSS PST CLEANER CARR 1301	825.41
				SZ NITRITE P F BLUE LG /	4,106.40
				SZ NITRILE P-F SFZN GNPRM	4,452.20
				FU GERMICIDAL FOAM / FULR	1,039.50
				LIVI FLAT FACIAL SOLP 115	725.40
				SSS BLUE GLASS CLEANER /	1,105.20
				SSS CARPET SPOTTING KIT /	186.08
				SSS WET WOOD HDL SCREW 60	165.60
				FU WORKHORSE SWPR / W/ BL	117.00
				FU GERMICIDAL FOAM CLNR 1	283.50
				TK ROLL TOWEL NATURAL / 8	2,991.80
				LINER 33X40 BLK / OVOL 33	1,386.72
				TK MULTI FOLD WHITE / ESS	2,464.00
				LINER 24X33 .35M BLK / OV	2,192.40
				TKC FOLD TOWEL WHITE 2400	1,740.20
				PURELL HAND SANI WIPES /	797.00
1516135	06/04/2021	31325	HIGH POINT SANITARY SOLUTIONS	1,962.50	
				HOT CUP W HANDLE SOLO378H	

# Check Register

Fiscal Year: 21      Period: 10

**Fund: 1991 - GENERAL FUND**

<u>check number</u>	<u>check date</u>	<u>vend no</u>	<u>vendor name and item descriptions</u>	<u>amount</u>
1516136	06/04/2021	88821	HOUSTON ARBORETUM & NATURE CENTER RENTAL CONTRACT FOR EVENT	1,790.00
1516137	06/04/2021	86348	5205 LIMITED PARTNERSHIP GEN SUPPLIES MATERIAL	792.00
1516147	06/04/2021	82248	METROPOLITAN LIFE INSURANCE COMPANY MAY2021 COBRA DHMO DE MAY2021 DHMO DENTAL C	3,851.39 27.70 3,823.69
1516149	06/04/2021	88698	NATIONAL TRAINING INSTITUTE ON RACE PA2021-0648 INV1223	2,500.00
1516150	06/04/2021	88623	OMAR REYNA JR REIMBURSE FEE MUSIC T	250.00
1516153	06/04/2021	88696	SIMON T BAILY INTERNATIONAL INC PA2021-0687 BOOKS PA2021-0687 BOOKS PA2021-0687 BOOKS	2,385.00 795.00 795.00 795.00
1516159	06/04/2021	83234	UNIVERSITY OF NORTH TEXAS PFIA TRAING MAY13&14	5,865.00
1516160	06/04/2021	87406	VERITIV OPERATING COMPANY CORRUGATED FILE BOX	2,291.45
1516161	06/04/2021	88087	VERSA CREATIVE GROUP LLC JUNE 21TRADITIONAL ME	21,026.00
1516246	06/10/2021	87967	A-1 PERSONNEL OF HOUSTON INC TMPWK ST041221-041821 TMPWK ST041921-042521 TEMPWK 042621-050221 WK051021-051621 F.J.N TMPWK ST040521-041121 TMPWK052521-053021 WK052421-053021 JD.EU TEMPWK 050321-051921 TMPWK032921-040421	9,760.86 648.00 1,069.20 1,138.86 2,339.40 648.00 2,122.20 369.60 1,182.60 243.00
1516249	06/10/2021	84427	APPRAISAL & COLLECTION TECHNOLOGIES TNT SOFTWARE FOR 1-3 ENTI	298.00
1516250	06/10/2021	13871	AT&T CORP PHONE 052121-062021 PHONE 051921-061821 PHONE 052121-062021	600.18 171.48 300.09 128.61
1516251	06/10/2021	13872	AT&T LONG DISTANCE LD 051721-061621	459.99
1516252	06/10/2021	88593	RUSSELL A BARKLEY PHD ADDITIONAL TRAVEL EXP SPEAKER AGREEMENT TO PRES	310.18 128.18 182.00
1516254	06/10/2021	88752	BEATRICE MAYES INSTITUTE REFUND ECOBOT CHALLENGE	1,200.00
1516255	06/10/2021	86386	ROBERT LEE BELL JR JUNE MILEAGE	10.98
1516256	06/10/2021	15860	BLACKMON-MOORING STEAMATIC INC FACILITIES SERVICE AGREEM FACILITIES SERVICE AGREEM	249,155.73 157,089.57 92,066.16
1516260	06/10/2021	82495	COMCAST CORPORATION COMCAST052621-062521	91.13
1516261	06/10/2021	88751	MISSHUNNA DAVIS TUTOR WILL PROVIDE AFTER	935.00

# Check Register

Fiscal Year: 21      Period: 10

**Fund: 1991 - GENERAL FUND**

<u>check number</u>	<u>check date</u>	<u>vend no</u>	<u>vendor name and item descriptions</u>	<u>amount</u>
1516263	06/10/2021	88807	EVE S KROENCKE WRITING AWARD RECIPIE	1,000.00
1516264	06/10/2021	88574	EXECU TEAM STAFFING TEMP STAFF	814.41
1516266	06/10/2021	88777	ANN FORD TUTOR WILL PROVIDE IN PER	1,100.00
1516267	06/10/2021	80775	FRENCH CORNER CATERING INC SCHOOLS DIV LUNCH MEE	200.00
1516270	06/10/2021	83037	GALENA PARK ISD GPISD TRANSPORTATION	133.30
1516275	06/10/2021	29920	HARRIS COUNTY TREASURER JULY2021 LAW ENFORCE JULY 2021 LAW ENFORCE JULY2021 LAW ENFORCE JULY2021 LAW ENFORCE AIRTIME	43,537.00 6,197.37 12,394.50 18,591.75 6,197.38 156.00
1516279	06/10/2021	86348	5205 LIMITED PARTNERSHIP GEN SUPP MATTERIALS	2,430.45
1516283	06/10/2021	88817	ALBERT BRADLEY JOULEVETTE REIMB FOR SUPPLIES	18.00
1516288	06/10/2021	86888	LONG PLAN PRINTING INC CUSTOM POCKET FOLDER	936.22
1516292	06/10/2021	88605	PHS CAPITAL LLC SOFTWARE AS A SERVICE WEB	2,950.00
1516293	06/10/2021	83247	PINNACLE MEDICAL MANAGEMENT CORP RANDOM SELECTION TEST (BY	40.00
1516295	06/10/2021	87278	POWERSCHOOL GROUP LLC PD+ ADMINISTRATION LICENS	1,257.53
1516297	06/10/2021	88750	JOSHUA RAGLON TUTOR WILL PROVIDE VIRTUA	440.00
1516302	06/10/2021	52199	SHI GOVERNMENT SOLUTIONS INC FRESHWORKS FRESHCALLER PH	568.43
1516307	06/10/2021	57378	TEXAS ASSOCIATION OF SCHOOL ADMIN PA2021-0712 HCDE INSI	1,400.00
1516308	06/10/2021	58389	TEXAS DEPARTMENT OF PUBLIC SAFETY CRIMINAL BACKGROUND CHECK	7.00
1516312	06/10/2021	61927	VERIZON WIRELESS CELL 032921-042821 CELL 042921-052821 CELL 032921-042821 CR	351.78 329.54 351.71 -329.47

# Check Register

Fiscal Year: 21      Period: 10

**Fund: 1991 - GENERAL FUND**

<u>check number</u>	<u>check date</u>	<u>vend no</u>	<u>vendor name and item descriptions</u>	<u>amount</u>
1516314	06/10/2021	61927	VERIZON WIRELESS	7,729.21
			VERIZON 050821-060721	-19.97
			VERIZON 050821-060721	38.11
			VERIZON 050821-060721	38.11
			VERIZON 050821-060721	38.17
			VERIZON 050821-060721	76.22
			VERIZON 050821-060721	76.22
			VERIZON 050821-060721	201.46
			VERIZON 050821-060721	269.40
			VERIZON 050821-060721	849.75
			VERIZON 050821-060721	38.11
			VERIZON 050821-060721	114.33
			VERIZON 050821-060721	125.24
			VERIZON 050821-060721	190.55
			VERIZON 050821-060721	201.46
			VERIZON 050821-060721	273.76
			VERIZON 050821-060721	342.99
			VERIZON 050821-060721	342.99
			VERIZON 050821-060721	38.11
			VERIZON 050821-060721	38.11
			VERIZON 050821-060721	38.11
			VERIZON 050821-060721	71.24
			VERIZON 050821-060721	76.22
			VERIZON 050821-060721	76.22
			VERIZON 050821-060721	926.22
			VERIZON 050821-060721	1,562.55
			VERIZON 050821-060721	38.11
			VERIZON 050821-060721	38.11
			VERIZON 050821-060721	76.22
			VERIZON 050821-060721	125.24
			VERIZON 050821-060721	266.81
			VERIZON 050821-060721	269.52
			VERIZON 050821-060721	366.55
			VERIZON 050821-060721	524.97

# Check Register

Fiscal Year: 21      Period: 10

**Fund: 1991 - GENERAL FUND**

<u>check number</u>	<u>check date</u>	<u>vend no</u>	<u>vendor name and item descriptions</u>	<u>amount</u>
1516317	06/10/2021	87489	DAHILL OFFICE TECHNOLOGY CORP MAY2021 LEASE	3,363.74 149.84
			MAY2021 LEASE	149.84
			MAY2021 LEASE	149.84
			MAY2021 LEASE	217.32
			MAY2021 LEASE	217.32
			MAY2021 LEASE	149.84
			MAY2021 LEASE	173.78
			MAY2021 LEASE	149.84
			MAY2021 LEASE	25.29
			MAY2021 LEASE	250.09
			MAY2021 LEASE	149.84
			MAY2021 LEASE	149.84
			MAY2021 LEASE	149.84
			MAY2021 LEASE	149.84
			MAY2021 LEASE	154.67
			MAY2021 LEASE	193.37
			MAY2021 LEASE	49.02
			MAY2021 LEASE	217.32
			MAY2021 LEASE	149.84
			MAY2021 LEASE	217.32
			MAY2021 LEASE	149.84
1516344	06/14/2021	80164	DAVID G PEAKE DED:2407 MISC	1,277.50
1516345	06/14/2021	31045	WILLIAM E HEITKAMP DED:2405 MISC	1,000.00
1516346	06/14/2021	34539	INTERNAL REVENUE SERVICE DED:1210 MISC	150.00
1516355	06/16/2021	88545	SOCIAL MOTION INC OCT20 SOCIAL MOTION	19,113.00
1516358	06/17/2021	25314	4IMPRINT ORIGINAL BEND A PEN ITEM#	865.74 182.70
			SET UP CHARGE FOR BEND A	45.00
			FREIGHT FOR BEND A PEN	9.36
			1 MIS CHARGE / LESS THAN	50.00
			FREIGHT	7.20
			SET UP CHARGE FOR PUZZLE	31.50
			FREIGHT FOR PUZZLE STRESS	15.24
			AZTEC SOUP MUG 12 OZ. ITE	129.24
			LESS THAN MINIMUM CHARGE	40.00
			TEAMWORK PUZZLE STRESS RE	319.50
			SET UP CHARGE	36.00
1516360	06/17/2021	86081	KRISTEN ALLEN SPRING LEADERSHIP ACA	935.00
1516361	06/17/2021	87542	ALWAYS IN SEASON, INC JUN21 PLANT MAINTEN	16.50
1516362	06/17/2021	87534	LUCY ANDERSON FACILITATE INSTRUCTION &	9,700.00 4,000.00
			FACILITATE THE STR COURSE	4,000.00
			FACILITATE THE DIFFERENTI	1,700.00
1516363	06/17/2021	13330	APPLE INC 10.2-INCH IPAD WI-FI 128G	956.00 798.00
			3-YEAR APPLE CARE+ FOR SCH	158.00

# Check Register

Fiscal Year: 21      Period: 10

**Fund: 1991 - GENERAL FUND**

<u>check number</u>	<u>check date</u>	<u>vend no</u>	<u>vendor name and item descriptions</u>	<u>amount</u>
1516364	06/17/2021	13871	AT&T CORP PHONE 052721-062621	128.61
1516367	06/17/2021	86982	CAPSULE TEK LLC TEMP STAFF ASSIST PROJECT MANAGER AN ASSIST PROJECT MANAGER AN	2,873.85 736.00 1,114.35 1,023.50
1516368	06/17/2021	88744	CAROL VAUGHN WRITING AND EDITING OTHER CONTRACTED SER	1,700.00
1516370	06/17/2021	82495	COMCAST CORPORATION INTERNET 053121-06302 INTERNET053021-062921	446.77 115.50 331.27
1516371	06/17/2021	84855	CYBERSOURCE CORPORATION GATEWAY MONTHLY SERVICE F	29.00
1516372	06/17/2021	83368	EDUPHORIA! INCORPORATED EDUPHORIA STRIVE SUBSCRIPT EDUPHORIA STRIVE SUBSCRIPT EDUPHORIA STRIVE SUBSCRIPT EDUPHORIA STRIVE SUBSCRIPT	3,980.00 995.00 995.00 995.00 995.00
1516378	06/17/2021	88722	HIGH POINT FU GERMICIDAL FOAM / FULR SSS ASSURE ANTIBACTERIAL FU BRASS DETAIL BRUSH / F FU WORKHORSE SWPR / W/ BL	2,448.20 850.50 1,495.50 24.20 78.00
1516380	06/17/2021	34241	INTERNATIONAL FOUNDATION OF MEMBERSHIP FOR REGINA JOH	245.00
1516381	06/17/2021	34705	J HARDING & CO SET UP FEE MEGA GROCERY SHOPPING TOT	377.50 55.00 322.50
1516393	06/17/2021	56650	TEXAS ASSOCIATION OF SCHOOL BOARDS HR SERVICES FOR PAY SYSTE	13,000.00
1516395	06/17/2021	88087	VERSA CREATIVE GROUP LLC JUN 21 SERVICES VE& A MAY 21 SOCI&OOGLE ADV	10,792.28 3,000.00 7,792.28
1516482	06/17/2021	87654	INSTANT DATA TECHNOLOGIES DBA INDAT JUNE SFC PRESENTER	500.00
1516485	06/24/2021	87967	A-1 PERSONNEL OF HOUSTON INC TEMPS WK 051721-05232 TEMPS WK053121-060621	3,832.50 2,133.30 1,699.20
1516492	06/24/2021	13871	AT&T CORP PHONE 061521-071421 PHONE JUN21 & FEB 21 PHONE 061121-071021 PHONE 060121-063021 PHONE JUN21 & FEB21 PH060521-070421&45.43 PH:060521-070421& FEB PHONE 060921-070821	2,338.66 44.75 247.68 434.40 385.83 247.68 270.10 340.16 368.06
1516493	06/24/2021	16888	BRUNSWICK PRESS INC BUDGET BOARDS 19 X 32 PRINT 1 SIDE	1,425.00 1,035.00 390.00
1516497	06/24/2021	88084	COMCAST HOLDINGS CORPORATION SIP TR 060121-063021 INTERNE 060121-063021	5,529.26 2,392.86 3,136.40

# Check Register

Fiscal Year: 21      Period: 10

**Fund: 1991 - GENERAL FUND**

<u>check number</u>	<u>check date</u>	<u>vend no</u>	<u>vendor name and item descriptions</u>	<u>amount</u>
1516498	06/24/2021	82495	COMCAST CORPORATION INTERNET 061121-07102	377.00
1516506	06/24/2021	88574	EXECU TEAM STAFFING PURCHASING CLERK TEMP PURCHASING CLERK TEMP	1,233.40 718.60 514.80
1516508	06/24/2021	25560	FEDERAL EXPRESS CORPORATION FEDEX EXPRESS SERVICE	609.07
1516509	06/24/2021	88689	PAUL FORBES PAUL FORBES WILL PRESENT	2,000.00
1516511	06/24/2021	80775	FRENCH CORNER CATERING INC PRINCIPAL INTERVIEWS PRINCIPAL INTERVIEWS PRINCIPAL INTERVIEWS	422.00 145.00 79.00 198.00
1516512	06/24/2021	29505	HALLMARK OFFICE PRODUCTS INC HONH105535LPT1 - 5 SHELF	2,565.00
1516514	06/24/2021	31037	GREENWOOD PUBLISHING GROUP LLC HEINEMANN CONSULTANT AUTH	3,560.00
1516515	06/24/2021	88722	HIGH POINT SSS DISINFECTANT DEOD 12/	334.56
1516519	06/24/2021	86348	5205 LIMITED PARTNERSHIP EVX-S24 UHF (403-470MHZ) EAR HANGER STYLE EARPIECE MICRO USB CHARGER	3,085.00 1,140.00 1,750.00 195.00
1516522	06/24/2021	88728	METHODIST HOSPITAL DBA HOUSTON METHODIST WELLNES	200.00
1516524	06/24/2021	87441	INFLOW COMMUNICATIONS INC GFI FAXMAKER SUBSCRIPTION GFI FAXMAKER SUBSCRIPTION GFI FAXMAKER SUBSCRIPTION	1,510.40 1,200.00 -108.78 419.18
1516530	06/24/2021	88130	LIBERTY DATA PRODUCTS INC CRTDG;LSR;HP 414A;YW LABEL;EZPEEL;LSR;1X2.6;WE CRTDG;LSR;HP 414A;BK PEN;GEL;G2;BOLD;BLACK PENCIL;COLORED;24/SET FOLDER;CLASSF;LTR;2"EX;2D CRTDG;LSR;HP 17A;BK MARKER;BROADLINE;8CT	1,573.93 390.54 167.50 301.77 98.28 160.40 209.76 161.38 84.30
1516533	06/24/2021	80942	OCCUPATIONAL HEALTH CENTERS CONCENTRA: SERVICES PERFO	121.00
1516534	06/24/2021	83247	PINNACLE MEDICAL MANAGEMENT CORP RANDOM SELECTION TEST (BY	518.00
1516539	06/24/2021	88818	CARMIESIA T STRAKER REIMBURSE POSTAGE	45.14
1516540	06/24/2021	56712	TEXAS ASSOCIATION OF SCHOOL WHITNEY COACHMAN TASBO MEMBERSHIP RENEWALS	270.00 135.00 135.00
1516541	06/24/2021	57378	TEXAS ASSOCIATION OF SCHOOL ADMIN TSB FULL PAGE AD INSIGHT FULL PAGE AD TASA DAILY SPONSORSHIP	4,400.00 1,200.00 1,200.00 2,000.00
1516542	06/24/2021	58931	TEXAS SCHOOL PUBLIC RELATIONS ASSOC PA2021-0763 TSPRA	525.00

# Check Register

Fiscal Year: 21      Period: 10

**Fund: 1991 - GENERAL FUND**

<u>check number</u>	<u>check date</u>	<u>vend no</u>	<u>vendor name and item descriptions</u>	<u>amount</u>
1516543	06/24/2021	87848	THE TURNING POINT INC JUNE2021	18,934.75 5,761.77
			MAY2021	13,172.98
1516548	06/24/2021	87406	VERITIV OPERATING COMPANY CV BUNDLE LIDS KITS B	6,603.20 2,020.30
			CV BUNDLE LIDS KITS B	2,291.45
			CV BUNDLE LIDS KITS	2,291.45
1516551	06/24/2021	85695	SHEILA WHITFORD FACILITATE COMMUNITIES OF	8,000.00 2,000.00
			FACILITATE STR COURSE FOR	4,000.00
			PREPARE COURSE SYLLABI FO	2,000.00
1516553	06/24/2021	87489	DAHILL OFFICE TECHNOLOGY CORP JUNE21 LEASE	3,363.74 154.67
			JUNE21 LEASE	149.84
			JUNE21 LEASE	25.29
			JUNE21 LEASE	149.84
			JUNE21 LEASE	49.02
			JUNE21 LEASE	250.09
			JUNE21 LEASE	149.84
			JUNE21 LEASE	193.37
			JUNE21 LEASE	149.84
			JUNE21 LEASE	173.78
			JUNE21 LEASE	149.84
			JUNE21 LEASE	217.32
			JUNE21 LEASE	217.32
			JUNE21 LEASE	149.84
			JUNE21 LEASE	217.32
			JUNE21 LEASE	149.84
			JUNE21 LEASE	149.84
			JUNE21 LEASE	149.84
			JUNE21 LEASE	149.84
			JUNE21 LEASE	217.32
			JUNE21 LEASE	149.84
1516595	06/30/2021	80164	DAVID G PEAKE DED:2407 MISC	1,277.50
1516596	06/30/2021	31045	WILLIAM E HEITKAMP DED:2405 MISC	1,000.00
1516597	06/30/2021	34539	INTERNAL REVENUE SERVICE DED:1210 MISC	150.00
V1516168	06/04/2021	87045	ADERONKE OLUWATOBI AKINFENWA MAY MILEAGE	45.36
V1516169	06/04/2021	10860	LEAH MAE ANGELITO ALBA APTA MEMBERSHIP REIMB	559.92 510.00
			MAY MILEAGE	49.92
V1516170	06/04/2021	86628	DENISE ODELL ALFORD MAY MILEAGE	46.48
V1516171	06/04/2021	88621	EVA MIRANDA AURICH-MENDOZA MAY MILEAGE	80.36
V1516172	06/04/2021	88118	RITU DAS BALLA MAY MILEAGE	16.24
V1516173	06/04/2021	87430	CRYSTAL LEIGH BEVERLY MAY MILEAGE	35.84



# Check Register

Fiscal Year: 21      Period: 10

**Fund: 1991 - GENERAL FUND**

<u>check number</u>	<u>check date</u>	<u>vend no</u>	<u>vendor name and item descriptions</u>	<u>amount</u>
V1516174	06/04/2021	85534	CARLENE DENISE BEXLEY MAY MILEAGE	19.04
V1516175	06/04/2021	15393	PRAGNA K BHALARA MAY MILEAGE	87.36
V1516179	06/04/2021	16438	MONICA M BRALLIER MAY MILEAGE	61.04
V1516181	06/04/2021	88013	ADELE MARIE KURT BRUNSON APRIL MILEAGE	38.08
V1516182	06/04/2021	17320	BUTLER BUSINESS PRODUCTS BUSINESS SOURCE HEAVY DUT BUSINESS SOURCE ROUND-RIN AVERY READY INDEX CUSTOM BUSINESS SOURCE PRESS-TO- WELCH'S FRUIT SNACKS BUSINESS SOURCE 1/3 TAB C	477.30 37.40 63.80 253.80 97.89 17.52 6.89
V1516184	06/04/2021	18165	CDW GOVERNMENT INC LENOVO ESSENTIAL WIRELE LENOVO PRO WIRED STEREO V TRIPP LITE DISPLAYPORT CA AUTOPILOT BASE DEPLOYMENT LENOVO 500 FHD WEBCAM - W VIEWSONIC GAMING MONITOR LENOVA THINK CENTRE M920S	1,557.80 49.69 84.38 23.84 17.95 68.44 274.38 1,039.12
V1516187	06/04/2021	88015	DAWN MARIE COMEAUX MAY MILEAGE	66.98
V1516189	06/04/2021	86117	TERESA DIANE DELAISLA TOTA MEMBERSHIP REIMB MAY MILEAGE	144.24 135.00 9.24
V1516190	06/04/2021	87738	MACKENZIE SPOONTS DEMPSEY MAY MILEAGE	38.64
V1516191	06/04/2021	83797	DISBURSEMENT REVIEW, LLC PA2021-0686 50% SHARE	7,058.13
V1516192	06/04/2021	81839	MICHELLE GANTER MAY MILEAGE	26.32
V1516193	06/04/2021	87411	ROBIN M GLENEWINKEL MAY MILEAGE AOTA MEMBERSHIP REIMB	225.64 94.64 131.00
V1516194	06/04/2021	84588	SARA ELIZABETH GOEKE APRIL MILEAGE	83.44
V1516195	06/04/2021	87575	ANALIEL NOQUEZ GONZALES REGISTRATION FEE REIM	300.00
V1516196	06/04/2021	29490	LISA M HALL MAY MILEAGE	25.76
V1516197	06/04/2021	88018	ASHLEY NICOLE SCOTT MAY MILEAGE	31.36
V1516200	06/04/2021	87257	HILLCO PARTNERS LLC MAY2021 PROFESSIONAL	23,000.00
V1516205	06/04/2021	88692	MARGARET JEANNE JOHNSON MAY MILEAGE	78.62
V1516206	06/04/2021	88356	CAROLINE VOTH JOHNSTON MAY MILEAGE	36.18
V1516207	06/04/2021	86488	CHERINA LANAE PETE MAY MILEAGE	36.57

# Check Register

Fiscal Year: 21      Period: 10

**Fund: 1991 - GENERAL FUND**

<u>check number</u>	<u>check date</u>	<u>vend no</u>	<u>vendor name and item descriptions</u>	<u>amount</u>
V1516208	06/04/2021	85126	MARLA LYNN SMITH KANAKIDIS MAY MILEAGE	31.81
V1516209	06/04/2021	82315	REBECCA RIKER NORTH SCHOOL BASED INTE DCD MAY MILEAGE	190.28 99.00 91.28
V1516210	06/04/2021	88348	ALDONA JOLANTA KLINE MAY MILEAGE	28.06
V1516211	06/04/2021	36435	BRENNA G KOLLMORGEN MAY MILEAGE	71.68
V1516213	06/04/2021	86222	ROBIN DIANE-RILLA KRONENBERGER MAY MILEAGE	51.86
V1516214	06/04/2021	36698	SUPRIYA KUMAR MAY MILEAGE	69.10
V1516215	06/04/2021	88645	KRISTEN N KUMMER APRIL MILEAGE MAY MILEAGE	23.85 6.55 17.30
V1516217	06/04/2021	85218	JOHANNA LEPS DE JAGER MAY MILEAGE	38.08
V1516218	06/04/2021	37855	MARSHA A LEWIS MAY MILEAGE	73.36
V1516219	06/04/2021	86497	SIMY MATHAI MAY MILEAGE	56.90
V1516220	06/04/2021	86078	MELINDA EMELIA MCGOULDRIK REIMB 5/13/21 SUPPLIE MAY MILEAGE	86.99 29.98 57.01
V1516221	06/04/2021	86936	SUSANNE MARIE MINKS MAY MILEAGE	33.21
V1516223	06/04/2021	83476	MONINA VICENCIO MORALES-ESTUART MAY MILEAGE	147.84
V1516226	06/04/2021	88350	ANNALISA DERILO PABLO MAY MILEAGE K-5 KEYBOARD& DIGITAL	161.86 51.86 110.00
V1516227	06/04/2021	85138	BARBARA JEAN PARKER MAY MILEAGE	104.50
V1516230	06/04/2021	46130	ANN K PETTY MAY MILEAGE	175.84
V1516231	06/04/2021	88333	JULIE CHRISTINE PLOETNER MAY MILEAGE	40.32
V1516235	06/04/2021	88624	RACHEL CHRISTINE SMITH TOTA OT MEMBERSHIP FE	76.00
V1516236	06/04/2021	84863	COLOR ONE SYSTEMS ABS EAST CHRON-LOG NCR	670.00
V1516237	06/04/2021	86174	APPDDICTION STUDIO LLC EDGAR FORMS IOS / ANDROID APPS MONTHL	500.01 291.67 208.34
V1516238	06/04/2021	60679	MARY JANE TROTTER MAY MILEAGE	98.00
V1516239	06/04/2021	60707	DENICE FEGETTE TUCKER MAY MILEAGE	112.56
V1516240	06/04/2021	87749	LAKEN MARIE WALKER MAY MILEAGE	101.36
V1516241	06/04/2021	88659	REBECCA ELLEN WATERMAN MAY MILEAGE	22.40

# Check Register

Fiscal Year: 21      Period: 10

**Fund: 1991 - GENERAL FUND**

<u>check number</u>	<u>check date</u>	<u>vend no</u>	<u>vendor name and item descriptions</u>	<u>amount</u>
V1516242	06/04/2021	83984	MARY F WEISENBURGER MAY MILEAGE	53.03
V1516243	06/04/2021	82607	VALARIE D WELTON MAY MILEAGE	81.20
V1516244	06/04/2021	86938	MARY ELLEN WENZEL MAY MILEAGE	39.76
V1516245	06/04/2021	64730	KARLA J YIELDING MAY MILEAGE	42.00
V1516320	06/10/2021	80626	JOYCE L AKINS REIMB REG FEE AFP CON	10.00
V1516321	06/10/2021	10860	LEAH MAE ANGELITO ALBA REIMB FOR TPTA MEMB	75.00
V1516322	06/10/2021	11485	PEPI CORPORATION HS JOB FAIR EVENT	626.05
V1516323	06/10/2021	83329	JESUS J AMEZCUA FEASIBILITY STUDY / C	210.56
V1516325	06/10/2021	17320	BUTLER BUSINESS PRODUCTS KNIFE,PRECISION, COFFEE MATE LIQUID COFFEE STORAGE,PAPER,CONSTRUCTIO	68.35 29.40 9.93 29.02
V1516326	06/10/2021	18165	CDW GOVERNMENT INC SAMSUNG C34H890WGN-CH89 S HP LASERJET PRO MFP TEMPERED GLASS SCREEN PRO APC BACK UPS PRO COMPACT	1,708.75 1,077.98 440.02 51.56 139.19
V1516327	06/10/2021	88685	MARCIAL G CHAVEZ MAY MILEAGE	340.54
V1516328	06/10/2021	60040	MONICA LYNN GARCIA MAY MILEAGE APRIL MILEAGE MARCH MILEAGE	102.82 25.87 53.65 23.30
V1516338	06/10/2021	88124	COLINA CATHERINE POUILLARD MAY MILEAGE	115.42
V1516342	06/10/2021	88493	YUNUS S UNIA MAY MILEAGE	320.60
V1516398	06/17/2021	86628	DENISE ODELL ALFORD JUNE MILEAGE	16.80
V1516399	06/17/2021	86538	PAMELA MARIE RHODES MAY MILEAGE	108.64
V1516400	06/17/2021	52395	KATHRYN A BAKER MAY MILEAGE	57.12
V1516401	06/17/2021	14485	THELMA J BANKS JUNE MILEAGE MAY MILEAGE	54.21 28.17 26.04
V1516402	06/17/2021	15261	STACY K BERKMAN MAY MILEAGE	28.56
V1516403	06/17/2021	87430	CRYSTAL LEIGH BEVERLY JUNE MILEAGE	22.40
V1516404	06/17/2021	15393	PRAGNA K BHALARA JUNE MILEAGE	54.88
V1516405	06/17/2021	15978	KELLEY RENEE BODINE JUNE MILEAGE MAY MILEAGE	66.08 15.68 50.40

# Check Register

Fiscal Year: 21      Period: 10

**Fund: 1991 - GENERAL FUND**

<u>check number</u>	<u>check date</u>	<u>vend no</u>	<u>vendor name and item descriptions</u>	<u>amount</u>
V1516412	06/17/2021	16778	DEBRA LYNNE BROWN MAY MILEAGE	30.24
V1516413	06/17/2021	88013	ADELE MARIE KURT BRUNSON MAY MILEAGE	101.58
V1516414	06/17/2021	17320	BUTLER BUSINESS PRODUCTS MAT,SELF HEALING,	120.18
V1516415	06/17/2021	85125	JANINE WALLACE CALMES MAY MILEAGE	30.74
V1516416	06/17/2021	88625	GLORIA CAMPOS MAY MILEAGE	52.02
V1516417	06/17/2021	18165	CDW GOVERNMENT INC LENOVO THINKPAD T14GEN 1- CDW AUTOPILOT BASE DEPLOY TARGUS CLASSIC TOPLOAD TRIPP LITE DISPLAYPORT CA LENOVO THINK PAD L15 GEN LENOVO THINKVISION T23I-2 BELKIN 6FT HIGH SPEED HDM MICROSOFT SURFACE PRO TYP MICROSOFT SURFACE PEN M17 TRIPP LITE DISPLAYPORT TO CDW AUTOPILOT BASE LOGITECH M185 USB WIRELES VIEWSONIC GAMING MONITOR STARTECH.COM USB 3.0 TO G	4,627.08 2,753.08 35.90 33.75 23.84 1,074.30 175.95 8.27 69.38 83.44 25.69 17.95 14.99 274.38 36.16
V1516419	06/17/2021	20203	AMY LINN COLLINS MAY MILEAGE	30.91
V1516421	06/17/2021	88626	KALENN LEIGH CRANE MAY MILEAGE	135.74
V1516422	06/17/2021	88633	REMI ZANETA DAVIS MAY MILEAGE JUNE MILEAGE	16.07 14.84 1.23
V1516423	06/17/2021	86117	TERESA DIANE DELAISLA JUNE MILEAGE	16.86
V1516424	06/17/2021	88352	KATHERINE ANN DOS SANTOS JUNE MILEAGE MAY MILEAGE	52.76 7.62 45.14
V1516425	06/17/2021	86523	ANNE M DOUBEK MAY MILEAGE	97.72
V1516426	06/17/2021	53023	JACQUELINE ALISON DOWELL MAY MILEAGE	59.64
V1516427	06/17/2021	88634	BROOKSIE L EDQUIST MAY MILEAGE MAY MILEAGE	44.52 29.96 14.56
V1516428	06/17/2021	88691	TIFFANY ALEXANDRA ESTES MAY MILEAGE	92.46
V1516430	06/17/2021	84589	HEATHER MARIE FAUNCE-ESTAY MAY MILEAGE JUNE MILEAGE	95.20 81.76 13.44
V1516431	06/17/2021	83350	WRIGHT EXPRESS FINANCIAL SVC CORP GAS MAY21	1,594.69
V1516432	06/17/2021	81839	MICHELLE GANTER JUNE MILEAGE	7.84

# Check Register

Fiscal Year: 21      Period: 10

**Fund: 1991 - GENERAL FUND**

<u>check number</u>	<u>check date</u>	<u>vend no</u>	<u>vendor name and item descriptions</u>	<u>amount</u>
V1516433	06/17/2021	87411	ROBIN M GLENEWINKEL JUNE MILEAGE	40.60
V1516434	06/17/2021	87575	ANALIEL NOQUEZ GONZALES MAY MILEAGE	56.84
V1516436	06/17/2021	84584	HOLLY LYNN SHAFER MAY MILEAGE	128.24
V1516437	06/17/2021	82107	TAMMY HILLEGEIST JUNE MILEAGE MAY MILEAGE	64.96 12.88 52.08
V1516440	06/17/2021	35600	CHARLOTTE MARIA JORDAN JUNE MILEAGE MAY MILEAGE	167.44 41.44 126.00
V1516442	06/17/2021	86222	ROBIN DIANE-RILLA KRONENBERGER JUNE MILEAGE	16.13
V1516443	06/17/2021	88632	ALYSSA BRIANA KUHN JUNE MILEAGE MAY MILEAGE	29.62 8.96 20.66
V1516444	06/17/2021	85532	ERICK LEON MAY MILEAGE	100.07
V1516446	06/17/2021	37855	MARSHA A LEWIS JUNE MILEAGE	45.36
V1516447	06/17/2021	86941	JAMIE KANE MACDONALD JUNE MILEAGE MAY MILEAGE	83.27 14.56 68.71
V1516448	06/17/2021	38955	SANDRA A MACGREGOR MAY MILEAGE	150.64
V1516449	06/17/2021	81372	TAMA JEAN MAGALLON MAY MILEAGE JUNE MILEAGE	41.78 15.74 26.04
V1516451	06/17/2021	82661	DEBORAH MATTHEWS MAY MILEAGE JUNE MILEAGE	74.48 51.52 22.96
V1516452	06/17/2021	39910	LAURA KAYE MCFARLAND MAY MILEAGE	54.32
V1516453	06/17/2021	40553	BEATRIZ M MENENDEZ MAY MILEAGE	51.52
V1516455	06/17/2021	83476	MONINA VICENCIO MORALES-ESTUART JUNE MILEAGE	98.56
V1516456	06/17/2021	85599	PRASHANTHI NAIDU NADELLA JUNE MILEAGE MAY MILEAGE	190.40 58.24 132.16
V1516457	06/17/2021	82231	ERIKA GREMILLION-NEAL JUNE MILEAGE MAY MILEAGE	76.16 32.48 43.68
V1516459	06/17/2021	44026	VICKI Y YOUNG NOLAN MAY MILEAGE	58.24
V1516461	06/17/2021	88350	ANNALISA DERILO PABLO JUNE MILEAGE	19.32
V1516462	06/17/2021	88622	TAMMY WOLFE PENA MAY MILEAGE JUNE MILEAGE	85.79 71.79 14.00
V1516463	06/17/2021	46130	ANN K PETTY JUNE MILEAGE	17.92

# Check Register

Fiscal Year: 21      Period: 10

**Fund: 1991 - GENERAL FUND**

<u>check number</u>	<u>check date</u>	<u>vend no</u>	<u>vendor name and item descriptions</u>	<u>amount</u>
V1516464	06/17/2021	35197	JENNIFER JONES RAMOS MAY MILEAGE	48.10
V1516465	06/17/2021	49632	CANDACE H RIEDER JUNE MILEAGE MAY MILEAGE	36.23 14.45 21.78
V1516466	06/17/2021	86525	CYRELLE FERN GARDNER MAY MILEAGE JUNE MILEAGE	101.30 81.20 20.10
V1516467	06/17/2021	84585	SUSAN RUDOLPH SCHWAI T ZBERG MAY MILEAGE	66.64
V1516469	06/17/2021	88624	RACHEL CHRISTINE SMITH JUNE MILEAGE MAY MILEAGE	62.39 12.66 49.73
V1516470	06/17/2021	85775	TAMARA FAYE SNOW JUNE MILEAGE MAY MILEAGE	77.28 11.76 65.52
V1516471	06/17/2021	83419	MARY A SNYDER JUNE MILEAGE MAY MILEAGE	154.00 75.60 78.40
V1516472	06/17/2021	87011	JENNA RENEE SPILLARS MAY MILEAGE JUNE MILEAGE	61.99 60.59 1.40
V1516473	06/17/2021	88627	LINDSAY MINGLE TAMEZ MAY MILEAGE	73.19
V1516475	06/17/2021	87979	JESSICA MARIE BERMEA MARCH MILEAGE	15.79
V1516476	06/17/2021	83984	MARY F WEISENBURGER JUNE MILEAGE	44.18
V1516477	06/17/2021	82607	VALARIE D WELTON JUNE MILEAGE	52.08
V1516478	06/17/2021	88666	RONESE J WILLS MAY MILEAGE	7.28
V1516479	06/17/2021	64008	TANYA S WISE JUNE MILEAGE MAY MILEAGE	35.06 15.12 19.94
V1516483	06/17/2021	83329	JESUS J AMEZCUA REIMBURSE LAKESH SUPP	148.09
V1516484	06/17/2021	86174	APPDDICTION STUDIO LLC PA2021-0726 PA FORM D SOFTWARE ASSISTANCE CONTR SOFTWARE PROGRAM ASSISTAN EDGAR FORMS IOS / ANDROID APPS MONTHL	12,588.61 1,089.00 7,411.68 3,587.92 291.67 208.34

# Check Register

Fiscal Year: 21      Period: 10

**Fund: 1991 - GENERAL FUND**

<u>check number</u>	<u>check date</u>	<u>vend no</u>	<u>vendor name and item descriptions</u>	<u>amount</u>
V1516559	06/24/2021	17320	BUTLER BUSINESS PRODUCTS	858.74
			BUSINESS SOURCE STANDARD	3.50
			MEAD 3-SUBJECT WIREBOUND	13.92
			KLEENEX ANTI-VIRAL FACIAL	43.49
			MEAD HEAVYWEIGHT SINGLE	7.83
			PAPER MATE RETRACTABLE PR	26.10
			1912769 HIGHLIGHTER 4PK	9.84
			E543 GLUE STICK	3.94
			CE403A TONER MAGENTA	245.99
			CE402A TONER YELLOW	245.99
			SPARCO COMPOSITION BOOKS	10.89
			XSTAMPER 10 ML BOTTLE REF	6.25
			SCOTCH HEAVY-DUTY SHIPPIN	20.87
			SCOTCH SUPER-STRENGTH PAC	4.17
			CLI NONTOXIC FOAM INK PAD	1.78
			CLI NONTOXIC FOAM INK PAD	1.78
			CLI NONTOXIC FOAM INK PAD	1.78
			BUSINESS SOURCE HIGH QUAL	4.12
			DURACELL COPPERTOP ALKALI	54.00
			50173 TISSUE 4/PK	21.18
			WOTAPP418 CORRECTION TAPE	10.65
			XSTAMPER 10 ML BOTTLE REF	6.26
			ENERGIZER INDUSTRIAL ALKA	41.88
			BUSINESS SOURCE HEAVY-DUT	16.48
			SCOTCH PRECISION SCISSORS	32.97
			KENSINGTON WIRELESS MOUSE	23.08
V1516560	06/24/2021	18165	CDW GOVERNMENT INC	2,029.37
			RESPAWN RSP-400 130 DEG.	285.36
			SAMSUNG QN55Q70TAF Q70T S	930.02
			SAMSUNG QN55Q70TAF Q70T S	813.99
V1516561	06/24/2021	84592	ANDREA NICHOLE DULWORTH	150.00
			REIMBURSE AOTA MEMBER	
V1516566	06/24/2021	86492	TRACI JANENE GAULT	125.00
			REIMBURSE REG FEE	
V1516567	06/24/2021	87575	ANALIEL NOQUEZ GONZALES	400.00
			REIMBURSE APTA MEMBER	
V1516568	06/24/2021	84584	HOLLY LYNN SHAFER	124.00
			REIMBURSE OT LICENCE	
V1516571	06/24/2021	84421	HOT SHOT DELIVERY INC	350.28
			060121-061521	
V1516572	06/24/2021	88310	RIZWAN HUSSAIN	8.85
			JUNE MILEAGE	
V1516574	06/24/2021	35600	CHARLOTTE MARIA JORDAN	125.00
			REIMBURSE AOTA MEMBER	
V1516576	06/24/2021	37855	MARSHA A LEWIS	150.00
			REIMBURSE REGIST FEE	
V1516577	06/24/2021	38955	SANDRA A MACGREGOR	249.99
			REIM REISTRATION FEE	
V1516578	06/24/2021	82661	DEBORAH MATTHEWS	131.00
			REIMBURSE AOTA MEMBER	
V1516579	06/24/2021	39910	LAURA KAYE MCFARLAND	225.00
			REIMBURSE AOTA MEMBER	

# Check Register

Fiscal Year: 21      Period: 10

**Fund: 1991 - GENERAL FUND**

<u>check number</u>	<u>check date</u>	<u>vend no</u>	<u>vendor name and item descriptions</u>	<u>amount</u>
V1516581	06/24/2021	85599	PRASHANTHI NAIDU NADELLA REIMBURSE REG FEE OT	125.00
V1516584	06/24/2021	86496	NORMA RAQUEL ROCHA REIMBURSE FEE EMERGEN	225.00
V1516585	06/24/2021	84928	ROSA MARIA MADRIGAL REIMBURSE MEETING MEA	58.54
V1516586	06/24/2021	87115	DEISY RUBIO TASBO 2021 SUMMER SOL TASBO 2021 SUMMER SOL	275.64 55.00 220.64
V1516587	06/24/2021	84585	SUSAN RUDOLPH SCHWAI T ZBERG REIMBURSE REG FEE OT	150.00
V1516588	06/24/2021	83419	MARY A SNYDER REIMBURSE REGIS FEE O	150.00
V1516589	06/24/2021	84623	SOA FIN1ST ASSIST BUS SVCS DAILY OPE	5,280.00
V1516592	06/24/2021	82607	VALARIE D WELTON REIMB FOR OTPT	150.00
V1516593	06/24/2021	88387	ASHLEY NADINE WOODS REIMB TOTA OT MEMBER	135.00

Number of checks in fund 1991 - GENERAL FUND: **251**

Amount total:      **701,838.20**

**Fund: 2051 - HEAD START**

<u>check number</u>	<u>check date</u>	<u>vend no</u>	<u>vendor name and item descriptions</u>	<u>amount</u>
1516105	06/04/2021	88718	VERONICA ASHTON BACOPULOS APRIL MILEAGE	120.96
1516121	06/04/2021	88574	EXECU TEAM STAFFING TEMPORARY CLERICAL STAFF	1,006.72
1516126	06/04/2021	87470	FRONTIER SOUTHWEST INCORPORATED PHONE 042021-051921	173.36
1516133	06/04/2021	86562	HARRIS COUNTY FWSD #51 WATER 052221-052021	28.50
1516144	06/04/2021	87249	LIQUID ENVIRONMENTAL OF TEXAS LLC QUARTERLY GREASE TRAP CLE	200.00
1516151	06/04/2021	88826	SYLVIA F RODRIGUEZ HS SCREENING REIMBURS	25.00
1516157	06/04/2021	88825	TANESHA R TOWNSEND INITIAL HEALTH REIMBU	25.00
1516162	06/04/2021	88782	WASP BARCODE TECHNOLOGIES WASP DATA IMPORT BY TRAIN FREIGHT COST SOFTWARE ASSET CLOUD OP C WASP 2HR REMOTE TRAINING	7,014.99 355.50 8.49 6,295.50 355.50
1516250	06/10/2021	13871	AT&T CORP PHONE 051921-061821 PHONE 052121-062021	317.61 128.61 189.00
1516253	06/10/2021	88748	IOLA RASHEDA BATT HEALTH REIMBURSMENT	25.00
1516259	06/10/2021	18491	CENTERPOINT ENERGY GAS 042121-052021 GAS 042221-052021	97.89 77.56 20.33



# Check Register

Fiscal Year: 21      Period: 10

**Fund: 2051 - HEAD START**

<u>check number</u>	<u>check date</u>	<u>vend no</u>	<u>vendor name and item descriptions</u>	<u>amount</u>
1516264	06/10/2021	88574	EXECU TEAM STAFFING	2,941.51
			TEMPORARY CLERICAL STAFF	298.87
			TEMPORARY CLERICAL STAFF	1,006.72
			TEMPORARY CLERICAL STAFF	1,006.72
			TEMPORARY CLERICAL STAFF	629.20
1516265	06/10/2021	88281	FIRE SAFE PROTECTION SERVICES LP	432.98
			MONITORING AND SECURITY S	
1516276	06/10/2021	85783	HARRIS COUNTY WATER CONTROL AND	166.48
			WATER 042621-052621	
1516278	06/10/2021	33040	CITY OF HOUSTON WATER	372.12
			WATER 042121-052721	309.31
			WATER 042221-052421	62.81
1516285	06/10/2021	37208	CITY OF LA PORTE	95.80
			WATER 052121-060721	
1516287	06/10/2021	87249	LIQUID ENVIRONMENTAL OF TEXAS LLC	300.00
			QUARTERLY GREASE TRAP CLE	
1516294	06/10/2021	88824	MARTHA ELVIA PONCE	40.58
			REIMBURSE FINGERPRINT	
1516298	06/10/2021	48800	RELIANT ENERGY	398.73
			ELEC 041621-051721	
1516315	06/10/2021	61927	VERIZON WIRELESS	1,295.40
			PHOCELL 052321-062221	
1516364	06/17/2021	13871	AT&T CORP	638.51
			PHONE 052721-062621	209.50
			PHONE 052721-062621	128.61
			PHONE 052721-062621 F	300.40
1516365	06/17/2021	82150	ANNETTE BAIRD	720.00
			SUMMER HEADS UP NEWSLETTE	
1516369	06/17/2021	18491	CENTERPOINT ENERGY	48.47
			HS GAS 050321-060221	
1516370	06/17/2021	82495	COMCAST CORPORATION	311.45
			PHONE 061021-070921	
1516374	06/17/2021	88574	EXECU TEAM STAFFING	1,006.72
			TEMPORARY CLERICAL STAFF	
1516382	06/17/2021	88523	EARIKA MARIE JACKSON	376.32
			MAY MILEAGE	114.24
			JUNE MILEAGE	13.44
			MARCH MILEAGE	120.96
			APRIL MILEAGE	127.68
1516383	06/17/2021	35131	JAMES LEWIS CUNNINGHAM	900.00
			CONTRACTED SERVICES AGREE	
1516384	06/17/2021	87249	LIQUID ENVIRONMENTAL OF TEXAS LLC	230.00
			QUARTERLY GREASE TRAP CLE	
1516396	06/17/2021	86242	WCA WASTE CORPORATION	168.83
			JUN 21 WASTE DISPOSA	
1516397	06/17/2021	62751	WASTE MANAGEMENT	949.32
			JUN 21 WASTE DISPOSA	112.58
			MAY 21 WASTE DISPOSA	84.44
			JUN 21 WASTE DISPOSA	92.44
			MAY 21 WASTE DISPOSA	168.87
			MAY 21 WASTE DISPOSA	253.31
			MAY 21 WASTE DISPOSA	112.58
			JUN 21 WASTE DISPOSA	125.10

# Check Register

Fiscal Year: 21

Period: 10

**Fund: 2051 - HEAD START**

<u>check number</u>	<u>check date</u>	<u>vend no</u>	<u>vendor name and item descriptions</u>	<u>amount</u>
1516491	06/24/2021	87353	AQUA TEXAS INC WATER 042721-052621	697.30
1516492	06/24/2021	13871	AT&T CORP PHONE 2021 &JUN21 PHONE 060721-070621 PHONE 061321-071221	993.74 465.08 357.82 170.84
1516495	06/24/2021	18491	CENTERPOINT ENERGY GAS 051221-061121	25.26
1516513	06/24/2021	29920	HARRIS COUNTY TREASURER MONTHLY RENTAL FEE OPEN	50.00
1516518	06/24/2021	32920	CITY OF HOUSTON HEALTH DEPARTMENT MONTHLY RENTAL FEE OPEN P MONTHLY RENTAL FEE	9,646.50 5,881.50 3,765.00
1516525	06/24/2021	83870	KQC INVESTORS, LLC MONTHLY RENTAL FEE BAYTOWN HS/EHS LEASE PAYM MONTHLY RENTAL FEE OPEN P	25,818.24 3,903.30 11,747.00 10,167.94
1516529	06/24/2021	87941	LIBERTY FIRE PROTECTION INC SENSITIVITY TEST FIRE ALARM INSPECTION	510.00 125.00 385.00
V1515736 void	05/07/2021	16155	MILK PRODUCTS LLC STUDENT FOOD - OPEN PURCH	-1,246.63 -67.73 -81.27 -54.18 -66.66 -81.27 -40.64 -54.18 -128.66 -27.09 -27.09 -27.09 -54.18 -153.77 -108.36 -81.27 -54.18 -54.18 -84.83

# Check Register

Fiscal Year: 21      Period: 10

**Fund: 2051 - HEAD START**

<u>check number</u>	<u>check date</u>	<u>vend no</u>	<u>vendor name and item descriptions</u>	<u>amount</u>	
V1515866	void	05/14/2021	16155	MILK PRODUCTS LLC	-968.03
				STUDENT FOOD - OPEN PURCH	-67.73
				STUDENT FOOD - OPEN PURCH	-203.04
				STUDENT FOOD - OPEN PURCH	-54.18
				STUDENT FOOD - OPEN PURCH	-40.64
				STUDENT FOOD - OPEN PURCH	-67.73
				STUDENT FOOD - OPEN PURCH	-67.73
				STUDENT FOOD - OPEN PURCH	-54.18
				STUDENT FOOD - OPEN PURCH	-54.18
				STUDENT FOOD - OPEN PURCH	-27.09
				STUDENT FOOD - OPEN PURCH	-27.09
				STUDENT FOOD - OPEN PURCH	-27.09
				STUDENT FOOD - OPEN PURCH	-123.10
				STUDENT FOOD - OPEN PURCH	-54.18
				STUDENT FOOD - OPEN PURCH	-100.07
V1515997	void	05/21/2021	16155	MILK PRODUCTS LLC	-1,446.76
				STUDENT FOOD - OPEN PURCH	-81.27
				STUDENT FOOD - OPEN PURCH	-54.18
				STUDENT FOOD - OPEN PURCH	-128.66
				STUDENT FOOD - OPEN PURCH	-54.18
				STUDENT FOOD - OPEN PURCH	-81.27
				STUDENT FOOD - OPEN PURCH	-98.37
				STUDENT FOOD - OPEN PURCH	-98.37
				STUDENT FOOD - OPEN PURCH	-67.73
				STUDENT FOOD - OPEN PURCH	-67.73
				STUDENT FOOD - OPEN PURCH	-27.09
				STUDENT FOOD - OPEN PURCH	-40.64
				STUDENT FOOD - OPEN PURCH	-27.09
				STUDENT FOOD - OPEN PURCH	-54.18
				STUDENT FOOD - OPEN PURCH	-75.55
				STUDENT FOOD - OPEN PURCH	-54.18
				STUDENT FOOD - OPEN PURCH	-27.09
				STUDENT FOOD - OPEN PURCH	-27.09
				STUDENT FOOD - OPEN PURCH	-54.18
				STUDENT FOOD - OPEN PURCH	-67.73
				STUDENT FOOD - OPEN PURCH	-40.64
				STUDENT FOOD - OPEN PURCH	-54.18
				STUDENT FOOD - OPEN PURCH	-27.09
				STUDENT FOOD - OPEN PURCH	-53.44
				STUDENT FOOD - OPEN PURCH	-84.83

# Check Register

Fiscal Year: 21      Period: 10

**Fund: 2051 - HEAD START**

<u>check number</u>	<u>check date</u>	<u>vend no</u>	<u>vendor name and item descriptions</u>	<u>amount</u>
V1516178	void	16155	MILK PRODUCTS LLC	0.00
			STUDENT FOOD - OPEN PURCH	-74.87
			STUDENT FOOD - OPEN PURCH	-54.18
			STUDENT FOOD - OPEN PURCH	-81.27
			STUDENT FOOD - OPEN PURCH	-40.64
			STUDENT FOOD - OPEN PURCH	-27.09
			STUDENT FOOD - OPEN PURCH	-40.64
			STUDENT FOOD - OPEN PURCH	-13.55
			STUDENT FOOD - OPEN PURCH	-27.09
			STUDENT FOOD - OPEN PURCH	-40.64
			STUDENT FOOD - OPEN PURCH	-128.66
			STUDENT FOOD - OPEN PURCH	-27.09
			STUDENT FOOD - OPEN PURCH	-62.73
			STUDENT FOOD - OPEN PURCH	-26.66
			STUDENT FOOD - OPEN PURCH	-27.09
			STUDENT FOOD - OPEN PURCH	-27.09
			STUDENT FOOD - OPEN PURCH	-27.09
			STUDENT FOOD - OPEN PURCH	-27.09
			STUDENT FOOD - OPEN PURCH	-81.27
			STUDENT FOOD - OPEN PURCH	-67.73
			STUDENT FOOD - OPEN PURCH	-81.27
			STUDENT FOOD - OPEN PURCH	-81.27
			STUDENT FOOD - OPEN PURCH	-94.82
			STUDENT FOOD - OPEN PURCH	-40.64
			STUDENT FOOD - OPEN PURCH	-54.18
			STUDENT FOOD - OPEN PURCH	-40.64
			STUDENT FOOD - OPEN PURCH	-27.09
			STUDENT FOOD - OPEN PURCH	-40.64
			STUDENT FOOD - OPEN PURCH	-40.64
			STUDENT FOOD - OPEN PURCH	-27.09
			STUDENT FOOD - OPEN PURCH	81.27
			STUDENT FOOD - OPEN PURCH	27.09
			STUDENT FOOD - OPEN PURCH	27.09
			STUDENT FOOD - OPEN PURCH	27.09
			STUDENT FOOD - OPEN PURCH	62.73
			STUDENT FOOD - OPEN PURCH	41.83
			STUDENT FOOD - OPEN PURCH	74.87
			STUDENT FOOD - OPEN PURCH	94.82
			STUDENT FOOD - OPEN PURCH	40.64
			STUDENT FOOD - OPEN PURCH	40.64
			STUDENT FOOD - OPEN PURCH	27.09
			STUDENT FOOD - OPEN PURCH	54.18
			STUDENT FOOD - OPEN PURCH	54.18
			STUDENT FOOD - OPEN PURCH	67.73
			STUDENT FOOD - OPEN PURCH	54.18
			STUDENT FOOD - OPEN PURCH	27.09
			STUDENT FOOD - OPEN PURCH	27.09
			STUDENT FOOD - OPEN PURCH	54.18
			STUDENT FOOD - OPEN PURCH	13.55
			STUDENT FOOD - OPEN PURCH	27.09
			STUDENT FOOD - OPEN PURCH	40.64
			STUDENT FOOD - OPEN PURCH	-67.73

# Check Register

Fiscal Year: 21      Period: 10

**Fund: 2051 - HEAD START**

<u>check number</u>	<u>check date</u>	<u>vend no</u>	<u>vendor name and item descriptions</u>	<u>amount</u>
V1516178	void	16155	MILK PRODUCTS LLC	0.00
			STUDENT FOOD - OPEN PURCH	-41.83
			STUDENT FOOD - OPEN PURCH	-168.78
			STUDENT FOOD - OPEN PURCH	-54.18
			STUDENT FOOD - OPEN PURCH	-40.64
			STUDENT FOOD - OPEN PURCH	-128.66
			STUDENT FOOD - OPEN PURCH	-27.09
			STUDENT FOOD - OPEN PURCH	-54.18
			STUDENT FOOD - OPEN PURCH	-27.09
			STUDENT FOOD - OPEN PURCH	13.55
			STUDENT FOOD - OPEN PURCH	128.66
			STUDENT FOOD - OPEN PURCH	128.66
			STUDENT FOOD - OPEN PURCH	40.64
			STUDENT FOOD - OPEN PURCH	40.64
			STUDENT FOOD - OPEN PURCH	81.27
			STUDENT FOOD - OPEN PURCH	81.27
			STUDENT FOOD - OPEN PURCH	81.27
			STUDENT FOOD - OPEN PURCH	-13.55
			STUDENT FOOD - OPEN PURCH	27.09
			STUDENT FOOD - OPEN PURCH	27.09
			STUDENT FOOD - OPEN PURCH	40.64
			STUDENT FOOD - OPEN PURCH	26.66
			STUDENT FOOD - OPEN PURCH	168.78
			STUDENT FOOD - OPEN PURCH	27.09
			STUDENT FOOD - OPEN PURCH	40.64
			STUDENT FOOD - OPEN PURCH	67.73
			STUDENT FOOD - OPEN PURCH	40.64
V1516182	06/04/2021	17320	BUTLER BUSINESS PRODUCTS	181.82
			REDI-TAG TAB STICKY NOTES	19.06
			POST-IT POP UP DISPENSER	12.37
			BUSINESS SOURCE TAPE DISP	5.25
			BUSINESS SOURCE ADHESIVE	23.28
			TOPS SPIRAL NOTEBOOK TOP6	5.97
			KLEENEX FACILA TISSUE KCC	13.28
			VERBATIM WIRELESS MOUSE R	17.29
			VERBATIM WIRELESS MOUSE B	17.29
			BUSINESS SOURCE STAPLER B	16.68
			COMPUCESSORY MOUSE PADS C	10.52
			OXFORD LETTER POCKET FOLD	17.26
			BUSINESS SOURCE STAINLESS	3.38
			PURELL SANITIZING GEL 8OZ	20.19
V1516199	06/04/2021	86933	HARDIES FRUIT & VEGETABLE CO	947.62
			STUDENT FOOD - OPEN PURCH	47.94
			STUDENT FOOD - OPEN PURCH	116.30
			STUDENT FOOD - OPEN PURCH	87.65
			STUDENT FOOD - OPEN PURCH	56.61
			STUDENT FOOD - OPEN PURCH	106.11
			STUDENT FOOD - OPEN PURCH	155.44
			STUDENT FOOD - OPEN PURCH	109.55
			STUDENT FOOD - OPEN PURCH	149.02
			STUDENT FOOD - OPEN PURCH	119.00

# Check Register

Fiscal Year: 21      Period: 10

**Fund: 2051 - HEAD START**

<u>check number</u>	<u>check date</u>	<u>vend no</u>	<u>vendor name and item descriptions</u>	<u>amount</u>
V1516216	06/04/2021	86944	LABATT INSTITUTIONAL SUPPLY COMPANY	2,304.16
			STUDENT FOOD - OPEN PURCH	422.28
			STUDENT FOOD - OPEN PURCH	950.26
			STUDENT FOOD - OPEN PURCH	15.30
			STUDENT FOOD - OPEN PURCH	135.90
			STUDENT FOOD - OPEN PURCH	258.60
			STUDENT FOOD - OPEN PURCH	211.02
			STUDENT FOOD - OPEN PURCH	168.09
			STUDENT FOOD - OPEN PURCH	142.71
V1516222	06/04/2021	83631	MARISSOL MONTALVO	34.72
			MARCH MILEAGE	14.56
			APRIL MILEAGE	20.16
V1516225	06/04/2021	81996	MICHELE ANDERSON NWOKOBIA	17.92
			APRIL MILEAGE	8.96
			MAY MILEAGE	8.96
V1516228	06/04/2021	88167	NAI'IMAH SHORT PARKER	40.58
			REIMBURE FINGERPRINT	
V1516325	06/10/2021	17320	BUTLER BUSINESS PRODUCTS	52.48
			DAWN MANUAL POT/PAN DETER	
V1516330	06/10/2021	86933	HARDIES FRUIT & VEGETABLE CO	782.56
			STUDENT FOOD - OPEN PURCH	48.70
			STUDENT FOOD - OPEN PURCH	65.35
			STUDENT FOOD - OPEN PURCH	79.57
			STUDENT FOOD - OPEN PURCH	52.99
			STUDENT FOOD - OPEN PURCH	120.26
			STUDENT FOOD - OPEN PURCH	241.78
			STUDENT FOOD - OPEN PURCH	173.91
V1516334	06/10/2021	52846	JULIE ANNE SMITH	6,000.00
			FACILITATOR OF ONGOING DE	
V1516335	06/10/2021	86944	LABATT INSTITUTIONAL SUPPLY COMPANY	2,425.56
			GLOVE, PWDR FREE LATEX ME	140.61
			CHLORINE TEST STRIPS 930-	5.50
			CUP 6OZ FOAM 729-1503	38.42
			STUDENT FOOD - OPEN PURCH	283.55
			HAIRNET BROWN REGULAR #67	117.84
			STUDENT FOOD - OPEN PURCH	50.11
			STUDENT FOOD - OPEN PURCH	738.13
			STUDENT FOOD - OPEN PURCH	230.03
			PLATE 7" LAMINATED WHITE	112.84
			STUDENT FOOD - OPEN PURCH	308.44
			STUDENT FOOD - OPEN PURCH	291.99
			CUTLERY SPOOK BULK MEDIUM	62.40
			NAPKIN BEV 1PLY WHITE 671	45.70

# Check Register

Fiscal Year: 21

Period: 10

**Fund: 2051 - HEAD START**

<u>check number</u>	<u>check date</u>	<u>vend no</u>	<u>vendor name and item descriptions</u>	<u>amount</u>
V1516339	06/10/2021	47923	QSS, L.C	3,064.75
			MONTHLY MONITORING AND MA	363.89
			MONTHLY MONITORING AND MA	13.85
			MONTHLY MONITORING AND MA	346.36
			MONTHLY MONITORING AND MA	373.64
			MONTHLY MONITORING AND MA	217.50
			MONTHLY MONITORING AND MA	375.52
			MONTHLY MONITORING AND MAI	280.97
			MONTHLY MONITORING AND MA	136.25
			MONTHLY MONITORING AND MA	339.74
			MONTHLY MONITORING AND MA	136.25
			MONTHLY MONITORING AND MA	237.50
			MONTHLY MONITORING AND MA	243.28

# Check Register

Fiscal Year: 21      Period: 10

**Fund: 2051 - HEAD START**

<u>check number</u>	<u>check date</u>	<u>vend no</u>	<u>vendor name and item descriptions</u>	<u>amount</u>
V1516411	06/17/2021	16155	MILK PRODUCTS LLC	6,412.37
			STUDENT FOOD - OPEN PURCH	54.18
			STUDENT FOOD - OPEN PURCH	76.28
			STUDENT FOOD - OPEN PURCH	40.64
			STUDENT FOOD - OPEN PURCH	53.44
			STUDENT FOOD - OPEN PURCH	27.09
			STUDENT FOOD - OPEN PURCH	67.73
			STUDENT FOOD - OPEN PURCH	67.73
			STUDENT FOOD - OPEN PURCH	81.27
			STUDENT FOOD - OPEN PURCH	54.18
			STUDENT FOOD - OPEN PURCH	40.64
			STUDENT FOOD - OPEN PURCH	67.73
			STUDENT FOOD - OPEN PURCH	81.27
			STUDENT FOOD - OPEN PURCH	84.83
			STUDENT FOOD - OPEN PURCH	27.09
			STUDENT FOOD - OPEN PURCH	27.09
			STUDENT FOOD - OPEN PURCH	203.04
			STUDENT FOOD - OPEN PURCH	81.27
			STUDENT FOOD - OPEN PURCH	81.27
			STUDENT FOOD - OPEN PURCH	54.18
			STUDENT FOOD - OPEN PURCH	54.18
			STUDENT FOOD - OPEN PURCH	13.55
			STUDENT FOOD - OPEN PURCH	81.27
			STUDENT FOOD - OPEN PURCH	54.18
			STUDENT FOOD - OPEN PURCH	74.87
			STUDENT FOOD - OPEN PURCH	67.73
			STUDENT FOOD - OPEN PURCH	40.64
			STUDENT FOOD - OPEN PURCH	27.09
			STUDENT FOOD - OPEN PURCH	27.09
			STUDENT FOOD - OPEN PURCH	27.09
			STUDENT FOOD - OPEN PURCH	-13.55
			STUDENT FOOD - OPEN PURCH	54.18
			STUDENT FOOD - OPEN PURCH	54.18
			STUDENT FOOD - OPEN PURCH	75.55
			STUDENT FOOD - OPEN PURCH	27.09
			STUDENT FOOD - OPEN PURCH	40.64
			STUDENT FOOD - OPEN PURCH	54.18
			STUDENT FOOD - OPEN PURCH	128.66
			STUDENT FOOD - OPEN PURCH	54.18
			STUDENT FOOD - OPEN PURCH	54.18
			STUDENT FOOD - OPEN PURCH	54.18
			STUDENT FOOD - OPEN PURCH	54.18
			STUDENT FOOD - OPEN PURCH	27.09
			STUDENT FOOD - OPEN PURCH	27.09
			STUDENT FOOD - OPEN PURCH	27.09
			STUDENT FOOD - OPEN PURCH	66.66
			STUDENT FOOD - OPEN PURCH	27.09
			STUDENT FOOD - OPEN PURCH	81.27
			STUDENT FOOD - OPEN PURCH	81.27
			STUDENT FOOD - OPEN PURCH	40.64
			STUDENT FOOD - OPEN PURCH	27.09
			STUDENT FOOD - OPEN PURCH	40.64
			STUDENT FOOD - OPEN PURCH	40.64



# Check Register

Fiscal Year: 21      Period: 10

**Fund: 2051 - HEAD START**

<u>check number</u>	<u>check date</u>	<u>vend no</u>	<u>vendor name and item descriptions</u>	<u>amount</u>
V1516411	06/17/2021	16155	MILK PRODUCTS LLC	6,412.37
			STUDENT FOOD - OPEN PURCH	27.09
			STUDENT FOOD - OPEN PURCH	27.09
			STUDENT FOOD - OPEN PURCH	54.18
			STUDENT FOOD - OPEN PURCH	67.73
			STUDENT FOOD - OPEN PURCH	27.09
			STUDENT FOOD - OPEN PURCH	67.73
			STUDENT FOOD - OPEN PURCH	13.55
			STUDENT FOOD - OPEN PURCH	206.82
			STUDENT FOOD - OPEN PURCH	54.18
			STUDENT FOOD - OPEN PURCH	54.18
			STUDENT FOOD - OPEN PURCH	67.73
			STUDENT FOOD - OPEN PURCH	98.37
			STUDENT FOOD - OPEN PURCH	123.10
			STUDENT FOOD - OPEN PURCH	153.77
			STUDENT FOOD - OPEN PURCH	128.66
			STUDENT FOOD - OPEN PURCH	108.36
			STUDENT FOOD - OPEN PURCH	54.18
			STUDENT FOOD - OPEN PURCH	54.18
			STUDENT FOOD - OPEN PURCH	54.18
			STUDENT FOOD - OPEN PURCH	40.64
			STUDENT FOOD - OPEN PURCH	40.64
			STUDENT FOOD - OPEN PURCH	54.18
			STUDENT FOOD - OPEN PURCH	26.66
			STUDENT FOOD - OPEN PURCH	41.83
			STUDENT FOOD - OPEN PURCH	128.66
			STUDENT FOOD - OPEN PURCH	128.66
			STUDENT FOOD - OPEN PURCH	40.64
			STUDENT FOOD - OPEN PURCH	40.64
			STUDENT FOOD - OPEN PURCH	71.18
			STUDENT FOOD - OPEN PURCH	98.37
			STUDENT FOOD - OPEN PURCH	40.64
			STUDENT FOOD - OPEN PURCH	27.09
			STUDENT FOOD - OPEN PURCH	67.73
			STUDENT FOOD - OPEN PURCH	27.09
			STUDENT FOOD - OPEN PURCH	27.09
			STUDENT FOOD - OPEN PURCH	27.09
			STUDENT FOOD - OPEN PURCH	100.07
			STUDENT FOOD - OPEN PURCH	98.37
			STUDENT FOOD - OPEN PURCH	67.73
			STUDENT FOOD - OPEN PURCH	67.73
			STUDENT FOOD - OPEN PURCH	81.27
			STUDENT FOOD - OPEN PURCH	40.64
			STUDENT FOOD - OPEN PURCH	54.18
			STUDENT FOOD - OPEN PURCH	84.83
			STUDENT FOOD - OPEN PURCH	67.73
			STUDENT FOOD - OPEN PURCH	81.27
			STUDENT FOOD - OPEN PURCH	94.82
			STUDENT FOOD - OPEN PURCH	168.78
			STUDENT FOOD - OPEN PURCH	62.73
			STUDENT FOOD - OPEN PURCH	27.09
			STUDENT FOOD - OPEN PURCH	27.09
			STUDENT FOOD - OPEN PURCH	27.09

# Check Register

Fiscal Year: 21      Period: 10

**Fund: 2051 - HEAD START**

<u>check number</u>	<u>check date</u>	<u>vend no</u>	<u>vendor name and item descriptions</u>	<u>amount</u>
V1516411	06/17/2021	16155	MILK PRODUCTS LLC STUDENT FOOD - OPEN PURCH	6,412.37 27.09
V1516454	06/17/2021	83631	MARISSOL MONTALVO MAY MILEAGE	27.44
V1516458	06/17/2021	88476	MONICA MARIE NILES MAY MILEAGE	16.80
V1516460	06/17/2021	81996	MICHELE ANDERSON NWOKOBIA MARCH MILEAGE	20.16
V1516557	06/24/2021	16155	MILK PRODUCTS LLC STUDENT FOOD - OPEN PURCH STUDENT FOOD - OPEN PURCH STUDENT FOOD - OPEN PURCH STUDENT FOOD - OPEN PURCH STUDENT FOOD - OPEN PURCH	154.82 4.30 29.90 57.84 8.60 54.18
V1516563	06/24/2021	85146	JOURNEY OF FAITH UNITED METHODIST MONTHLY RENTAL FEE	4,000.00
V1516575	06/24/2021	86944	LABATT INSTITUTIONAL SUPPLY COMPANY NON FOOD ITEMS NON FOOD ITEMS STUDENT FOOD - OPEN PURCH	174.16 24.02 45.27 104.87
V1516583	06/24/2021	47923	QSS, L.C PA2021-0730 REPAIR CE	22.21
V1516594	06/24/2021	64845	ZIEBEN FOUNDATION PROPERTIES MONTHLY RENT OPEN PURCHAS	5,657.04

Number of checks in fund 2051 - HEAD START: **61**      Amount total: **86,845.04**

**Fund: 2061 - HEAD START TRAINING**

<u>check number</u>	<u>check date</u>	<u>vend no</u>	<u>vendor name and item descriptions</u>	<u>amount</u>
1516359	06/17/2021	83233	MBR, INC SUPPLIES FOR VARIQUEST PR SHIPPING	189.90 179.90 10.00

Number of checks in fund 2061 - HEAD START TRAINING: **1**      Amount total: **189.90**

**Fund: 2070 - HEAD START DISASTER ASSIS**

<u>check number</u>	<u>check date</u>	<u>vend no</u>	<u>vendor name and item descriptions</u>	<u>amount</u>
1516262	06/10/2021	88662	DOUCET & ASSOCIATES INC PREPARE A LAND TITLE SURV	6,290.41
1516315	06/10/2021	61927	VERIZON WIRELESS PHOCELL 052321-062221	49.02
V1516188	06/04/2021	87401	ERC ENVIRONMENTAL & CONST SERV INC ASBESTOS INSPECTION AND R	3,590.00

Number of checks in fund 2070 - HEAD START DISASTER ASSIS: **3**      Amount total: **9,929.43**

**Fund: 2081 - EDUCATORS & FAMILIES ENGL**

<u>check number</u>	<u>check date</u>	<u>vend no</u>	<u>vendor name and item descriptions</u>	<u>amount</u>
1516316	06/10/2021	88737	ERIN C WEST ACP REIMB FEE PROGRAM	500.00

Number of checks in fund 2081 - EDUCATORS & FAMILIES ENGL: **1**      Amount total: **500.00**

**Fund: 2101 - STOP SCHOOL VIOLENCE GRNT**

<u>check number</u>	<u>check date</u>	<u>vend no</u>	<u>vendor name and item descriptions</u>	<u>amount</u>
---------------------	-------------------	----------------	--	---------------

# Check Register

Fiscal Year: 21      Period: 10

**Fund: 2101 - STOP SCHOOL VIOLENCE GRNT**

<u>check number</u>	<u>check date</u>	<u>vend no</u>	<u>vendor name and item descriptions</u>	<u>amount</u>
1516314	06/10/2021	61927	VERIZON WIRELESS VERIZON 050821-060721	381.10
V1516333	06/10/2021	86147	JEFFERY P MCGOWEN SPEAKER FEE FOR THREAT AS	600.00

Number of checks in fund 2101 - STOP SCHOOL VIOLENCE GRNT: **2**      Amount total: **981.10**

**Fund: 2141 - EARLY HEADSTART START-UP**

<u>check number</u>	<u>check date</u>	<u>vend no</u>	<u>vendor name and item descriptions</u>	<u>amount</u>
1516262	06/10/2021	88662	DOUCET & ASSOCIATES INC LAND SURVEYING GIS, LIDAR	1,269.96
1516373	06/17/2021	88648	ENGLISH + ASSOCIATES ARCHITECTS INC PROVIDE A PRELIMINARY DES	1,600.00

Number of checks in fund 2141 - EARLY HEADSTART START-UP: **2**      Amount total: **2,869.96**

**Fund: 2151 - EARLY HEADSTART OPERATION**

<u>check number</u>	<u>check date</u>	<u>vend no</u>	<u>vendor name and item descriptions</u>	<u>amount</u>
1516162	06/04/2021	88782	WASP BARCODE TECHNOLOGIES SOFTWARE ASSET CLOUD OP C WASP 2HR REMOTE TRAINING WASP DATA IMPORT BY TRAIN FREIGHT COST	779.44 699.50 39.50 39.50 0.94
1516265	06/10/2021	88281	FIRE SAFE PROTECTION SERVICES LP MONITOR CELLULAR ANNU	347.02
1516315	06/10/2021	61927	VERIZON WIRELESS PHOCELL 052321-062221	114.33
1516365	06/17/2021	82150	ANNETTE BAIRD SUMMER HEADS UP NEWSLETTE	80.00
1516369	06/17/2021	18491	CENTERPOINT ENERGY EHS GAS 050321-060221	38.84
1516383	06/17/2021	35131	JAMES LEWIS CUNNINGHAM CONTRACTED SERVICES AGREE	100.00
1516397	06/17/2021	62751	WASTE MANAGEMENT JUN 21 WASTE DISPOSA	122.58
1516525	06/24/2021	83870	KQC INVESTORS, LLC EHS MONTHLY RENTAL FEE	9,415.00
V1515736 void	05/07/2021	16155	MILK PRODUCTS LLC STUDENT MEALS STUDENT MEALS	-27.23 -8.23 -19.00
V1515866 void	05/14/2021	16155	MILK PRODUCTS LLC STUDENT MEALS STUDENT MEALS	-40.30 -15.21 -25.09
V1515997 void	05/21/2021	16155	MILK PRODUCTS LLC STUDENT MEALS	-9.33
V1516178	06/04/2021	16155	MILK PRODUCTS LLC STUDENT MEALS STUDENT MEALS STUDENT MEALS STUDENT MEALS STUDENT MEALS STUDENT MEALS STUDENT MEALS STUDENT MEALS STUDENT MEALS	0.00 5.17 -5.17 -9.26 -20.85 3.29 9.26 20.85 -3.29

# Check Register

Fiscal Year: 21      Period: 10

**Fund: 2151 - EARLY HEADSTART OPERATION**

<u>check number</u>	<u>check date</u>	<u>vend no</u>	<u>vendor name and item descriptions</u>	<u>amount</u>
V1516185	06/04/2021	87181	FELLOWSHIP OF PURPOSE EARLY CHILDHO INVOICES FOR CHILD CARE S INVOICES FOR CHILD CARE S	4,040.00 2,005.00 2,035.00
V1516212	06/04/2021	87246	DESKOT LLC CHILD CARE PARTNER INVOIC	3,665.00
V1516216	06/04/2021	86944	LABATT INSTITUTIONAL SUPPLY COMPANY EHS BAYTOWN STUDENT MEALS	117.45
V1516334	06/10/2021	52846	JULIE ANNE SMITH FACILITATOR OF ONGOING DE	300.00
V1516335	06/10/2021	86944	LABATT INSTITUTIONAL SUPPLY COMPANY EHS BAYTOWN STUDENT MEALS EHS BAYTOWN STUDENT MEALS EHS BAYTOWN STUDENT MEALS DISHWASHER TEST STRIPS # DELIMER, MAX CONTROL # 96	207.24 6.19 28.43 91.22 28.54 52.86
V1516339	06/10/2021	47923	QSS, L.C MONTHLY MONITORING AND MA	11.10
V1516411	06/17/2021	16155	MILK PRODUCTS LLC STUDENT MEALS STUDENT MEALS STUDENT MEALS STUDENT MEALS STUDENT MEALS STUDENT MEALS STUDENT MEALS STUDENT MEALS STUDENT MEALS STUDENT MEALS STUDENT MEALS	140.99 3.29 25.56 9.26 15.21 25.09 8.23 19.00 20.85 9.33 5.17
V1516418	06/17/2021	87181	FELLOWSHIP OF PURPOSE EARLY CHILDHO INVOICES FOR CHILD CARE S	1,628.00
V1516439	06/17/2021	86996	JOHN G JONES LEARNING CENTER TO PAY CHILD CARE PARTNER TO PAY CHILD CARE PARTNER	2,254.00 952.00 1,302.00
V1516441	06/17/2021	87246	DESKOT LLC CHILD CARE PARTNER INVOIC	3,247.00
V1516445	06/17/2021	87247	LETS LEARN CHRISTIAN LEARNING CTR CHILD CARE PARTNER INVOIC CHILD CARE PARTNER INVOIC	2,180.00 1,090.00 1,090.00
V1516557	06/24/2021	16155	MILK PRODUCTS LLC STUDENT MEALS	42.75
V1516575	06/24/2021	86944	LABATT INSTITUTIONAL SUPPLY COMPANY EHS BAYTOWN STUDENT MEALS	130.27

Number of checks in fund 2151 - EARLY HEADSTART OPERATION: **25**      Amount total: **28,884.15**

**Fund: 2301 - FEDERAL ADULT ED REGULAR**

<u>check number</u>	<u>check date</u>	<u>vend no</u>	<u>vendor name and item descriptions</u>	<u>amount</u>
1516116	06/04/2021	86276	DEIRDRE J WILLIAMS BUS ADM ENTRY LEVMAY2	20,400.00

# Check Register

Fiscal Year: 21      Period: 10

**Fund: 2301 - FEDERAL ADULT ED REGULAR**

<u>check number</u>	<u>check date</u>	<u>vend no</u>	<u>vendor name and item descriptions</u>	<u>amount</u>
1516119	06/04/2021	88048	DATA RECOGNITION CORPORATION TABE E-11 MATH SCOREZE PK TABE D-12 MATH SCOREZE PK TABE A-12 MATH SCOREZE PK TABE E-12 MATH SCOREZE PK TABE M-11 MATH SCOREZE PK TABE M-12 MATH SCOREZE PK TABE D-11 MATH SCOREZE PK TABE A-11 MATH SCOREZE PK SHIPPING & HANDLING	24,110.96 2,208.60 3,312.90 2,208.60 2,208.60 3,312.90 3,312.90 3,312.90 2,208.60 2,024.96
1516120	06/04/2021	88819	EIGHT MILLION STORIES, INC FACILITY USAGE FOR UTILIT	7,200.00
1516258	06/10/2021	86349	BURLINGTON ENGLISH INC. BURLINGTON ENGLISH ONLINE	47,232.00
1516268	06/10/2021	88783	FUEL UP FOR LIFE FOUNDATION INC OPEN PURCHASE ORDER	7,200.00
1516271	06/10/2021	85464	E LEARN INC GED TESTING SERVICE OFFIC COMPLETE TABE 11/12 AND G ESSAY SCORING ONE TIME ACTIVATION FEE COMPLETE DREAM CATCHER PR COMPLETE COMPUTER, WORK A	49,248.75 786.25 19,733.50 4,080.00 199.00 5,250.00 19,200.00
1516296	06/10/2021	86862	PS LIGHTWAVE INC JUNE21 THERNET CHARG	379.72
1516302	06/10/2021	52199	SHI GOVERNMENT SOLUTIONS INC MICROSOFT SURFACE GO TYPE MICROSOFT SURFACE GO2 TAB	9,482.76 1,077.93 8,404.83
1516314	06/10/2021	61927	VERIZON WIRELESS VERIZON 050821-060721	1,878.78
1516317	06/10/2021	87489	DAHILL OFFICE TECHNOLOGY CORP MAY2021 LEASE MAY2021 LEASE MAY2021 LEASE MAY2021 LEASE	599.36 149.84 149.84 149.84 149.84
1516481	06/17/2021	87470	FRONTIER SOUTHWEST INCORPORATED PHONE 060121-063021	71.77
1516492	06/24/2021	13871	AT&T CORP PHONE 060121-063021	355.75
1516494	06/24/2021	80139	CENTER FOR APPLIED LINGUISTICS BEST-FORMD: BEST LITERACY BEST PLUS 2.0 COMPUTER AD BEST-MANUAL2008: BEST LIT BP2TAG: BEST PLUS 2.0 TES BPPR-018: BEST PLUS SCORI BEST-FORMB: BEST LITERACY SHIPPING: DEFAULT SHIPPIN BEST-FORMC: BEST LITERACY	26,640.00 1,950.00 14,800.00 4,000.00 540.00 1,000.00 1,950.00 450.00 1,950.00
1516499	06/24/2021	87415	COMUNIQUEMOS INC OPEN PURCHASE ORDER	2,500.00
1516502	06/24/2021	88811	CHRISTOPHER DRAFT OPEN PURCHASE ORDER	6,000.00

# Check Register

Fiscal Year: 21

Period: 10

**Fund: 2301 - FEDERAL ADULT ED REGULAR**

<u>check number</u>	<u>check date</u>	<u>vend no</u>	<u>vendor name and item descriptions</u>	<u>amount</u>
1516527	06/24/2021	37570	LEE COLLEGE OPEN PURCHASE ORDER	7,650.00
1516532	06/24/2021	43900	NEW READERS PRESS PUBLISHING 7167 NEW READERS PRESS ON 7165 NEW READERS PRESS ON	46,800.00 40,500.00 6,300.00
1516537	06/24/2021	86862	PS LIGHTWAVE INC PA2021-0745 JUNE DIFF JUNE21	252.84 126.88 125.96
1516553	06/24/2021	87489	DAHILL OFFICE TECHNOLOGY CORP PA2021-0746 JUN21 LEA	299.68
V1516182	06/04/2021	17320	BUTLER BUSINESS PRODUCTS SHARPENER,PENCIL,ELEC,BLK SHARPENER,PENCIL,ELEC,BLK WIPES,DSNFCTNG,700CT	1,894.30 165.20 165.20 1,563.90

# Check Register

Fiscal Year: 21      Period: 10

**Fund: 2301 - FEDERAL ADULT ED REGULAR**

<u>check number</u>	<u>check date</u>	<u>vend no</u>	<u>vendor name and item descriptions</u>	<u>amount</u>
V1516325	06/10/2021	17320	BUTLER BUSINESS PRODUCTS	11,926.53
			HIGHLIGHTER,DSK,CHSL,FLPK	23.40
			HIGHLIGHTER,DSK CHSL,FLGN	23.40
			CALCULATOR,DSKTP,12DIG,LC	275.84
			DRIVE,FLASH,USB,16GB,5PK	76.62
			NOTEBOOK,WIREBOUND,LGE,PP	79.50
			INK REFL,STAMP,BTL,10ML,B	43.75
			TONER,CLJ PRO MFP M180,BL	407.92
			TONER,CLJ PRO MFP M180,MA	455.92
			REMOVER,STAPLE,W/MAGNET,B	24.04
			STAPLES,CHISEL PT,STD	7.50
			STAPLER,STAND-UP,FULL STR	147.12
			PADS,SS,NOTES,4"X4",MIAMI	33.72
			MASK,FACE,PR,ADULT,BLU	782.40
			RUBBER BAND,FILE,7X1/8,1/	50.28
			HIGHLIGHTER,DSK,CHSL,FLYL	23.40
			PAPER,NOTE,POST-IT,AST	98.80
			BINDER,VIEW,RR,,5,WHT	11.10
			COVER,RPT,DURACLIP,60SH,B	32.28
			CRTDG,LSR,HP 58A BL	423.96
			INK CRG,IJ,HP950XL,BLK	134.97
			FILE,VERT,LGL,26.5",2DWR,	432.90
			TONER,LJ 305X,BK	617.97
			PADS,SS,NOTES,4"X6",MIAMI	26.22
			CALCULATOR,DSKTP,12DIG,LC	168.94
			SURPRESSOR,SURGE,7OUT,7'	170.16
			ENVELOPE,CLASP,9X12,KFT	25.53
			BINDER,VIEW,2",2PK	130.14
			COVER,RPT,DURACLIP,30SH,R	26.28
			INK CRG,IJ,HP951XL,CYA	104.97
			MARKER,SHRPIE.MET,AST,3PK	21.93
			INK CRG,IJ,HP951XL,MAG	104.97
			INK CRG,IJ,HP 951XL,YEL	104.97
			FILE,VERT,LGL,26.5",4DWR,	1,248.80
			SANITIZER,PURELL,ECON,2L	1,593.00
			TAPE,ACRYLIC,2"X55YD,CLEA	55.74
			STAMP,5IN1,SFI,ECON,RECY	142.32
			BINDER,VIEW,ROUND,1",WE	24.23
			INK REFL,STAMP,BTL,10ML,R	43.82
			TONER,CLJ PRO MFP M180,CY	455.92
			TONER,CLJ PRO MFP M180,YE	455.92
			CHAIRMAT,46X60,RECT,CLR	199.96
			TONER,LJ 305A,CMY	713.98
			BOARD,4 X 3,GLSS MRKR,WH	498.12
			WIPE,DNSFCT,MULTI PK,3EA/	1,403.82
V1516332	06/10/2021	88793	I'M CHANGING THE NARRATIVE INC	3,450.00
			OPEN PURCHASE ORDER	
V1516343	06/10/2021	88729	BASHELIA WARD	3,400.00
			IMPLICIT BIAS TRAININ	
V1516438	06/17/2021	88447	HTEC-HOUSTONS TRAINING AND	11,250.00
			EDUCATIONAL AND VOCATIONA	
V1516450	06/17/2021	88788	BRANDON E MARTIN	6,900.00
			OPEN PURCHASE ORDER	

# Check Register

Fiscal Year: 21      Period: 10

**Fund: 2301 - FEDERAL ADULT ED REGULAR**

<u>check number</u>	<u>check date</u>	<u>vend no</u>	<u>vendor name and item descriptions</u>	<u>amount</u>
V1516559	06/24/2021	17320	BUTLER BUSINESS PRODUCTS	10,113.94
			DESK, PED BF, MIRELLA, SD	535.78
			CREDENZA,MIRELLA, BBB/BF,	1,143.99
			BOOKCASE, MIRELLA, 5 SHEL	685.46
			CREDENZA, TOP, W/MODPNL,	361.95
			CONFERENCE TABLE 42" TABL	336.00
			CHAIR, ERGHUMN ELITE, HB,	855.00
			DESK TOP W/MOD PAN MIRELL	510.79
			APOLLO GUEST CHAIR BLACK	504.00
			CREDENZA, MIRELLA, BBB/BF	1,143.99
			BOOKCASE, MIRELLA, 5 SHEL	685.46
			EUROPA-MIDBK TTNM FRM	1,088.00
			DESK TOP W/MOD PAN MIRELL	510.79
			DESK, PED, BF, MIRELLA, S	535.78
			CREDENZA, TIP, W/MODPNL,	361.95
			CHAIR, ERGHUMN ELITE, HB,	855.00
V1516562	06/24/2021	88785	FOCALPOINTK12 INC	40,000.00
			SOFTWARE CURRICULUM	
V1516564	06/24/2021	88147	DR WALTER MILTON JR	11,298.80
			BH365 EBOOKS	
V1516565	06/24/2021	87517	BIANCA YADHIRA GARCIA	8.74
			MAY MILEAGE	
V1516573	06/24/2021	88793	I'M CHANGING THE NARRATIVE INC	16,350.00
			OPEN PURCHASE ORDER	3,450.00
			OPEN PURCHASE ORDER	3,450.00
			OPEN PURCHASE ORDER	6,000.00
			OPEN PURCHASE ORDER	3,450.00

Number of checks in fund 2301 - FEDERAL ADULT ED REGULAR: **30**      Amount total: **374,894.68**

**Fund: 2341 - FED-ADULT ED-EL/CIVICS**

<u>check number</u>	<u>check date</u>	<u>vend no</u>	<u>vendor name and item descriptions</u>	<u>amount</u>
1516553	06/24/2021	87489	DAHILL OFFICE TECHNOLOGY CORP	299.68
			PA2021-0746 JUN21 LEA	
V1516564	06/24/2021	88147	DR WALTER MILTON JR	5,500.00
			BH365 EBOOKS	

Number of checks in fund 2341 - FED-ADULT ED-EL/CIVICS: **2**      Amount total: **5,799.68**

**Fund: 2671 - FED 21ST CENTURY CYC 9**

<u>check number</u>	<u>check date</u>	<u>vend no</u>	<u>vendor name and item descriptions</u>	<u>amount</u>
1516098	06/04/2021	10960	ALDINE INDEPENDENT SCHOOL DISTRICT	6,892.73
			MAR21 CYLE9YR5 DREW	
1516127	06/04/2021	27070	GALENA PARK ISD	17,011.89
			033121 NORTHSHORE 9TH	9,184.28
			123120 NORTHSHORE	7,827.61



# Check Register

Fiscal Year: 21      Period: 10

**Fund: 2671 - FED 21ST CENTURY CYC 9**

<u>check number</u>	<u>check date</u>	<u>vend no</u>	<u>vendor name and item descriptions</u>	<u>amount</u>
1516138	06/04/2021	32530	HOUSTON ISD	100,429.33
			FEB21 CHAVEZ	11,193.39
			MAR21 CHAVEZ	12,436.78
			OCT20 CHAVEZ	12,203.41
			NOV20 CHAVEZ	18,140.48
			FEB21 CHAVEZ	20,120.66
			SEPT20 CHAVEZ	5,558.58
			JAN21 CHAVEZ	8,745.95
			DEC20 CHAVEZ	12,030.08
1516141	06/04/2021	33610	HUMBLE INDEPENDENT SCHOOL DISTRICT	10,523.56
			DEC20 STERLING	
1516152	06/04/2021	52120	SHELDON INDEPENDENT SCHOOL DISTRICT	12,591.97
			DEC20 NULL MIDDLE	
1516156	06/04/2021	88525	BOX PROGRAM	1,200.00
			CONTRACT SERVICES-21ST CC	
1516247	06/10/2021	10960	ALDINE INDEPENDENT SCHOOL DISTRICT	10,453.92
			APR21CYCLE9 YR5 DREW	
1516301	06/10/2021	52120	SHELDON INDEPENDENT SCHOOL DISTRICT	54,623.72
			FEB21 NULL	13,308.19
			JAN21 NULL	14,165.20
			MAR21 NULL	13,538.28
			APR21 NULL	13,612.05
1516350	06/16/2021	27070	GALENA PARK ISD	11,884.31
			FEB21 NS9TH	
1516488	06/24/2021	87823	AFTER SCHOOL TO ACHIEVE	5,175.00
			MAY21 CONTRACT DISCOV	720.00
			MAY21 CONTRACT NULL	360.00
			MAY21 CONTRACT DREW A	1,440.00
			APR21 CONTRACT DREW A	1,530.00
			APR21 CONTRACT NULL	360.00
			APR21 CONTRACT DISCOV	765.00
1516489	06/24/2021	84484	ALIEF INDEPENDENT SCHOOL DISTRICT	22,522.33
			FEB21 ALBRIGHT	10,585.83
			JAN21 ALBRIGHT	11,936.50
V1516204	06/04/2021	86875	AUDREY GALE JEFFERSON-HARRISON	208.10
			APRIL MILEAGE	46.09
			APRIL MILEAGE	85.18
			APRIL MILEAGE	76.83
V1516325	06/10/2021	17320	BUTLER BUSINESS PRODUCTS	193.05
			SMEAD FILE FOLDER, DARK B	47.69
			SMEAD COLORED 1/3 TAB CUT	58.69
			SMEAD FILE FOLDER, GREEN,	47.69
			CHARLES LEONARD MAGNETIC	38.98

Number of checks in fund 2671 - FED 21ST CENTURY CYC 9: **13**      Amount total: **253,709.91**

**Fund: 2681 - FED 21ST CENTURY CYCLE 10**

<u>check number</u>	<u>check date</u>	<u>vend no</u>	<u>vendor name and item descriptions</u>	<u>amount</u>
1516106	06/04/2021	43683	NEIGHBORHOOD CENTERS INC	10,071.45
			033121 PROMISE SCHOOL	
1516127	06/04/2021	27070	GALENA PARK ISD	9,537.76
			033121 TICE ELEMENTAR	

# Check Register

Fiscal Year: 21      Period: 10

**Fund: 2681 - FED 21ST CENTURY CYCLE 10**

<u>check number</u>	<u>check date</u>	<u>vend no</u>	<u>vendor name and item descriptions</u>	<u>amount</u>
1516152	06/04/2021	52120	SHELDON INDEPENDENT SCHOOL DISTRICT FEB21 CE KING MID	76,897.26 10,143.43
			MAR21 ROYALWOOD	11,133.76
			JAN21 CE KING HIGH	8,247.61
			MAR21 CE KING HIGH	8,918.76
			MAR21 CE KING MID	8,941.62
			FEB21 ROYALWOOD	9,357.76
			JAN21 CE KING MID	10,001.87
			FEB21 CE KING HIGH	10,152.45
1516269	06/10/2021	27070	GALENA PARK ISD 033121 NORTHSHORE	9,157.36
1516303	06/10/2021	88745	SISTERS EMPOWRING S.I.S.T.A.S. INC. CONTRACT SERVICES-21ST CC	9,800.00
1516356	06/16/2021	86200	TEJANO CENTER FOR COMMUNITY CONCERN OCT20 HOUSTON STEM	34,135.58 11,238.59
			SEPT20 HOUSTON STEM	3,475.61
			NOV20 HOUSTON STEM	9,322.91
			AUG20 HOUSTON STEM	10,098.47
1516375	06/17/2021	87809	SHERIAN G DOYLE CONTRACT SERVICES-21ST CC	150.00
1516389	06/17/2021	86281	ALBAN G DIXON CONTRACT SERVICES	2,000.00
1516488	06/24/2021	87823	AFTER SCHOOL TO ACHIEVE MAR21CONTRACT ROYALWO	7,280.00 140.00
			APR21CONTRACT TICE EL	180.00
			MAY21CONTRACT ROYALWO	490.00
			MAR21 CONTRACT NORTH	180.00
			APR21 CONTRACT NORTH	990.00
			MAY21CONTRACT TICE EL	900.00
			MAY21 CONTRACT NORTH	900.00
			MAR21CONTRACT WIIAMS	150.00
			APR21CONTRACT WIIAMS	450.00
			APR21CONTRACT ROYALWO	560.00
			MAR21CONTRACT BAKER R	990.00
			APR21CONTRACT BAKER R	1,350.00
1516510	06/24/2021	23615	FOTOFEST INC CONTRACT SERVICES	1,920.00 360.00
			CONTRACT SERVICES	120.00
			CONTRACT SERVICES	1,440.00
1516552	06/24/2021	86827	WORLD YOUTH FOUNDATION INC CONTRACT SERVICES-21ST CC	2,000.00 900.00
			CONTRACT SERVICES-21ST CC	1,100.00
1516553	06/24/2021	87489	DAHILL OFFICE TECHNOLOGY CORP JUNE21 LEASE	50.80
V1516183	06/04/2021	88083	JASMINE IVAH CASTLEBERRY MARCH MILEAGE	148.35 12.71
			MAY MILEAGE	18.82
			APRIL MILEAGE	116.82
V1516234	06/04/2021	87574	MONIQUE JALAYNE SMITH APRIL MILEAGE	42.56
V1516468	06/17/2021	87574	MONIQUE JALAYNE SMITH MAY MILEAGE	16.69

# Check Register

Fiscal Year: 21      Period: 10

Number of checks in fund 2681 - FED 21ST CENTURY CYCLE 10: **15** Amount total: **163,207.81**

**Fund: 2880 - FED-AFTER SCHOOL PTNRSHIP**

<u>check number</u>	<u>check date</u>	<u>vend_no</u>	<u>vendor name and item descriptions</u>	<u>amount</u>
1516139	06/04/2021	82408	HOUSTON TENNIS ASSOCIATION INC SELECT SERVICES PROGRAM -	3,600.00
1516164	06/04/2021	88445	YAWP RECORDS LLC SELECT SERVICE PROGRAM -	2,250.00
1516280	06/10/2021	82408	HOUSTON TENNIS ASSOCIATION INC SELECT SERVICES PROGRAM -	200.00
1516289	06/10/2021	86359	MINDWORKS RESOURCES INCORPORATED AFTERSCHOOL HOME PROJECT	10,000.00
1516487	06/24/2021	87297	ABEL GARZA SELECT SERVICES PROGRAM -	2,900.00
1516528	06/24/2021	80734	LEGO EDUCATION LARGE STORAGE BY LEGO EDU LEGO MINDSTORMS EDUCATION	1,669.35 419.85 1,249.50
V1516180	06/04/2021	82525	BRAZILIAN ARTS FOUNDATION SELECT SERVICES PROGRAM -	2,280.00
V1516184	06/04/2021	18165	CDW GOVERNMENT INC PHILIPS VOICE TRACER DVT4 CANON PIXMA TS302- PRINTE	698.66 630.07 68.59
V1516324	06/10/2021	82525	BRAZILIAN ARTS FOUNDATION SELECT SERVICES PROGRAM -	1,425.00
V1516480	06/17/2021	86871	ANGELINA H RODRIGUEZ SELECT SERVICES PROGRAM -	1,420.00

Number of checks in fund 2880 - FED-AFTER SCHOOL PTNRSHIP: **10** Amount total: **26,443.01**

**Fund: 2881 - FED-AFTER SCHOOL PTNRSHIP**

<u>check number</u>	<u>check date</u>	<u>vend_no</u>	<u>vendor name and item descriptions</u>	<u>amount</u>
1516099	06/04/2021	84484	ALIEF INDEPENDENT SCHOOL DISTRICT FEB21 HEFLIN E. FEB21 MARTIN E. FEB21 MAHANAY	1,159.87 150.85 495.54 513.48
1516103	06/04/2021	80898	THE ARTIST BOAT INC SELECT SERVICE LIESTM	2,500.00
1516109	06/04/2021	84341	BOT SHOP, LLC SELECT SERVICE PROGRAM -A	3,500.00
1516118	06/04/2021	87859	MARY E WHITE LIT WITH LITERACY WORKSHO	600.00
1516124	06/04/2021	23615	FOTOFEST INC SELECT SERVICE PROGRAM -	630.00
1516142	06/04/2021	80722	BAYOU CITY FENCING ACADEMY SELECT SERVICES PROGRAM -	590.00
1516143	06/04/2021	82325	CSCRM INC DBA JUMP BUNCH SELECT SERVICES PROGRAM - SELECT SERVICES PROGRAM - SELECT SERVICES PROGRAM -	2,175.00 300.00 450.00 1,200.00
1516145	06/04/2021	87610	MATH-A-MATICS TUTORING, LLC SELECT SERVICES PROGRAM -	225.00 2,855.00

# Check Register

Fiscal Year: 21      Period: 10

**Fund: 2881 - FED-AFTER SCHOOL PTNRSHIP**

<u>check number</u>	<u>check date</u>	<u>vend no</u>	<u>vendor name and item descriptions</u>	<u>amount</u>
1516257	06/10/2021	86521	BOYS AND GIRLS CLUBS OF GREATER NOV20 HOLTHOUSE	10,241.84 1,599.69
			NOV20 JOHN & CISSY	1,732.64
			OCT20 JOHN & CISSY	2,520.59
			OCT20 HOLTHOUSE	2,600.48
			DEC20 HOLTHOUSE	921.17
			DEC20 JOHN & CISSY	867.27
1516282	06/10/2021	87196	JILLIAN SIMMONS REAL SELF WORKSHOP	3,500.00
1516284	06/10/2021	36910	LAKESHORE LEARNING MATERIALS REWARD TREASURE CHEST	1,397.96 759.80
			WRITE-WIPE WORLD WALL MAP	638.16
1516289	06/10/2021	86359	MINDWORKS RESOURCES INCORPORATED AFTERSCHOOL HOME ESSENTIA	35,000.00 30,240.00
			AFTERSCHOOL HOME PROJECT	3,770.00
			FREIGHT	990.00
1516290	06/10/2021	80610	ARISTOLE CORPORATION SAFETY PINS COILLESS PK/5	2,439.60 99.00
			FLOSS EMBROIDERY JUMBO/10	433.20
			POM POMS ASST PK300	1,280.40
			FLOSS EMBROIDERY JUMBO/10	627.00
1516300	06/10/2021	50480	S & S WORLDWIDE INC WHITE REXLACE LACING 100Y	3,749.26 348.10
			LAMINATED JUMBO WALL CALE	70.50
			JAYPRO LOCKABLE WALL MOUN	159.98
			JAYPRO SURFACE MOUNT BENC	1,353.68
			WHITE PACON ARRAY CARD ST	1,545.60
			WHITE REXLACE LACING 100Y	271.40
1516312	06/10/2021	61927	VERIZON WIRELESS CELL 032921-042821 CR	351.77 -329.47
			CELL 032921-042821	329.54
			CELL 042921-052821	351.70
1516317	06/10/2021	87489	DAHILL OFFICE TECHNOLOGY CORP MAY2021 LEASE	299.68 149.84
			MAY2021 LEASE	149.84
1516318	06/10/2021	81964	YOUNG AUDIENCES OF HOUSTON SELECT SERVICE PROGRAM -	3,240.00 1,620.00
			SELECT SERVICE PROGRAM -	1,620.00
1516347	06/16/2021	82169	ACADEMY OF ACCELERATED LEARNING MAR21 BELLFORT	6,873.13 1,754.37
			MAR21 CHIMNEY ROCK	5,118.76
1516348	06/16/2021	84484	ALIEF INDEPENDENT SCHOOL DISTRICT MAR21 MAHANAY	37,091.83 2,882.97
			APR21 MAHANAY	5,242.70
			MAR21 LIESTMAN	2,550.85
			APR21 LIESTMAN	4,508.89
			MAR21 MARTIN	3,280.64
			APR21 CUMMINGS	4,476.59
			APR21 HEFLIN	941.15
			APR21 MARTIN	3,852.59
			MAR21 OUTLEY	2,837.50
			APR21 OUTLEY	3,327.60
			MAR21 CUMMINGS	3,190.35

# Check Register

Fiscal Year: 21      Period: 10

**Fund: 2881 - FED-AFTER SCHOOL PTNRSHIP**

<u>check number</u>	<u>check date</u>	<u>vend no</u>	<u>vendor name and item descriptions</u>	<u>amount</u>
1516349	06/16/2021	86521	BOYS AND GIRLS CLUBS OF GREATER JAN21 JOHN & CISSY	7,951.31 790.24
			JAN21 HOLTHOUSE	882.57
			FEB21 HOLTHOUSE	1,684.77
			APR21 HOLTHOUSE	2,934.88
			FEB21 JOHN & CISSY	1,658.85
1516351	06/16/2021	32530	HOUSTON ISD	14,358.42
			FEB21 OATES	2,421.12
			FEB21 BRISCOE	3,218.61
			FEB21 LYONS	621.07
			MAR21 LYONS	1,516.54
			MAR21 OATES	2,484.01
			MAR21 BRISCOE	4,097.07
1516352	06/16/2021	85132	MULTICULTURAL EDUCATION AND NOV20 MECA DOW	4,303.19 1,878.38
			OCT20 MECA DOW	2,424.81
1516353	06/16/2021	45610	PASADENA ISD	15,731.17
			APR21 FRAZIER	5,333.68
			MAR21 FRAZIER	4,680.53
			FEB21 FRAZIER	5,716.96
1516354	06/16/2021	52120	SHELDON INDEPENDENT SCHOOL DISTRICT	16,888.50
			APR21 GARRETT	2,036.13
			MAR21 CARROLL	1,243.71
			FEB21 CARROLL	1,442.49
			APR21 CARROLL	1,552.78
			FEB21 GARRETT	1,714.59
			MAR21 SHELDON	2,143.26
			APR20 SHELDON	2,189.13
			FEB21 SHELDON	2,609.70
			MAR21 GARRETT	1,956.71
1516355	06/16/2021	88545	SOCIAL MOTION INC	887.00
			OCT20 SOCIAL MOTION	
1516357	06/16/2021	81964	YOUNG AUDIENCES OF HOUSTON NOV20 BFHC REED RD	2,595.00
1516510	06/24/2021	23615	FOTOFEST INC	1,210.00
			SELECT SERVICE PROGRAM -	180.00
			SELECT SERVICE PROGRAM -	410.00
			SELECT SERVICE PROGRAM -	310.00
			SELECT SERVICE PROGRAM -	310.00
1516526	06/24/2021	36910	LAKESHORE LEARNING MATERIALS	3,885.72
			WIGGLY EYES	219.12
			PEEL-STICK FLEXIBL FOAM S	626.67
			SPANGLES AND SEQUINS-CLAS	344.52
			OPAQUE ASST PONY BEADS	1,850.55
			TISSUE PAPER SQUARES	500.34
			COLORED FEATHERS - CLASS	344.52
1516547	06/24/2021	82161	URBAN HARVEST	1,991.50
			SELECT SERVICES PROGRAM -	1,351.50
			SELECT SERVICES PROGRAM -	640.00
1516553	06/24/2021	87489	DAHILL OFFICE TECHNOLOGY CORP	248.88
			JUNE21 LEASE	149.84
			JUNE21 LEASE	99.04

# Check Register

Fiscal Year: 21      Period: 10

**Fund: 2881 - FED-AFTER SCHOOL PTNRSHIP**

<u>check number</u>	<u>check date</u>	<u>vend no</u>	<u>vendor name and item descriptions</u>	<u>amount</u>
V1516184	06/04/2021	18165	CDW GOVERNMENT INC LENOVO THINKPAD AC 45W PO	287.25
V1516224	06/04/2021	86800	BRANDI KESSEE NICHOLS APRIL MILEAGE	49.50
V1516233	06/04/2021	87336	CHARMETTE JONES SELECT SERVICES PROGRAM –	1,600.00
V1516319	06/10/2021	86987	DYRUN ENTERPRISES INC PA2021-0720 SEL TRAIN	600.00
V1516340	06/10/2021	87336	CHARMETTE JONES SELECT SERVICES PROGRAM – SELECT SERVICES PROGRAM – SELECT SERVICES PROGRAM –	2,800.00 1,600.00 800.00 400.00
V1516341	06/10/2021	88308	SJ VISUAL ARTS PRODUCTION SELECT SERVICE PROGRAM - SELECT SERVICE PROGRAM -	1,890.00 810.00 1,080.00
V1516480	06/17/2021	86871	ANGELINA H RODRIGUEZ SELECT SERVICES PROGRAM –	6,650.00
V1516559	06/24/2021	17320	BUTLER BUSINESS PRODUCTS AJM PACKAGING GREEN LABEL ROYLCO FEELY FABRICS SENS ROYLCO FEELY FABRICS SENS ZIPLOC® SEAL TOP GALLON F	2,461.80 135.69 387.84 678.72 1,259.55
V1516560	06/24/2021	18165	CDW GOVERNMENT INC TRIPP LITE 6IN DISPLAYPOR STARTECH.COM 6FT 2M DISPL	47.72 23.86 23.86

Number of checks in fund 2881 - FED-AFTER SCHOOL PTNRSHIP: **39**      Amount total: **204,631.90**

**Fund: 4671 - LOC-CITY OF HOUSTON**

<u>check number</u>	<u>check date</u>	<u>vend no</u>	<u>vendor name and item descriptions</u>	<u>amount</u>
1516097	06/04/2021	86501	5WORKS INC CITY OF HOUSTON CITY CONN CITY OF HOUSTON CITY CONN	5,000.00 3,000.00 2,000.00
1516100	06/04/2021	87816	ALLIANCE FINANCIAL MINISTRIES INC CITY OF HOUSTON CITY CONN	1,000.00
1516110	06/04/2021	87543	CHANGE HAPPENS CITY OF HOUSTON CITY CONN	1,000.00
1516111	06/04/2021	19208	CHINESE COMMUNITY CENTER CITY OF HOUSTON CITY CONN	2,000.00
1516112	06/04/2021	88674	CHRIST ROSE FOUNDATION INCORPORATED CITY OF HOUSTON CITY CONN	2,000.00
1516113	06/04/2021	86457	COLLEGE COMMUNITY CAREER INC CITY OF HOUSTON CITY CONN	2,000.00
1516117	06/04/2021	88670	DOUBLE VISION DANCE INC CITY OF HOUSTON CITY CONN	1,400.00
1516122	06/04/2021	88414	EZ KIDS CREATIVITY SHELL CITY OF HOUSTON CITY CONN CITY OF HOUSTON CITY CONN	3,500.00 2,000.00 1,500.00
1516123	06/04/2021	87210	FORGE FOR FAMILIES CITY OF HOUSTON CITY CONN	1,000.00
1516128	06/04/2021	86751	GIRLS ON THE RUN GREATER HOUSTON CITY OF HOUSTON CITY CONN CITY OF HOUSTON CITY CONN	3,000.00 1,000.00 2,000.00

# Check Register

Fiscal Year: 21      Period: 10

**Fund: 4671 - LOC-CITY OF HOUSTON**

<u>check number</u>	<u>check date</u>	<u>vend no</u>	<u>vendor name and item descriptions</u>	<u>amount</u>
1516130	06/04/2021	87549	GREATER EMMANUEL FAMILY WORSHIP CEN CITY OF HOUSTON CITY CONN	1,000.00
1516140	06/04/2021	86092	HOUSTON YOUTH SYMPHONY AND BALLET CITY OF HOUSTON CITY CONN	1,000.00
1516154	06/04/2021	87075	SPRINGSPIRIT INC CITY OF HOUSTON CITY CONN	2,000.00
1516155	06/04/2021	88669	TEXAS GENERATION ONE INC CITY OF HOUSTON CITY CONN	5,000.00
1516163	06/04/2021	82067	WESLEY COMMUNITY CENTER INC CITY OF HOUSTON CITY CONN	1,000.00
1516165	06/04/2021	64735	YMCA CITY OF HOUSTON CITY CONN	2,000.00
1516166	06/04/2021	81964	YOUNG AUDIENCES OF HOUSTON CITY OF HOUSTON CITY CONN	2,000.00
1516248	06/10/2021	88671	AMERICAN FESTIVAL FOR THE ARTS CITY OF HOUSTON CITY CONN CITY OF HOUSTON CITY CONN	2,000.00 1,000.00 1,000.00
1516273	06/10/2021	88672	GREATER HOUSTON LULAC COUNCIL 4967 CITY OF HOUSTON CITY CONN	1,000.00
1516277	06/10/2021	82033	HITS THEATRE CITY OF HOUSTON CITY CONN	2,000.00
1516291	06/10/2021	87007	NEWSPRING CITY OF HOUSTON CITY CONN	2,000.00
1516305	06/10/2021	84070	SPIRIT OF YOUTH FENCING FOUNDATION CITY OF HOUSTON CITY CONN	1,800.00
1516306	06/10/2021	87552	ST MARTHA CATHOLIC SCHOOL CITY OF HOUSTON CITY CONN	2,000.00
1516310	06/10/2021	82161	URBAN HARVEST CITY OF HOUSTON CITY CONN	1,700.00
1516311	06/10/2021	82237	URBAN OUTREACH INC CITY OF HOUSTON CITY CONN	1,500.00
1516318	06/10/2021	81964	YOUNG AUDIENCES OF HOUSTON CITY OF HOUSTON CITY CONN	1,000.00
1516366	06/17/2021	86521	BOYS AND GIRLS CLUBS OF GREATER CITY OF HOUSTON CITY CONN	2,000.00
1516377	06/17/2021	87294	GIRLSTART CITY OF HOUSTON CITY CONN CITY OF HOUSTON CITY CONN	3,400.00 1,000.00 2,400.00
1516387	06/17/2021	87849	NATIONAL COLLEGE READINESS INST CITY OF HOUSTON CITY CONN CITY OF HOUSTON CITY CONN	3,670.25 1,870.25 1,800.00
1516388	06/17/2021	82235	PROJECT GRAD HOUSTON CITY OF HOUSTON CITY CONN	2,000.00
1516390	06/17/2021	87217	SEWA INTERNATIONAL INC CITY OF HOUSTON CITY CONN CITY OF HOUSTON CITY CONN	2,500.00 1,000.00 1,500.00
1516391	06/17/2021	88545	SOCIAL MOTION INC CITY OF HOUSTON CITY CONN CITY OF HOUSTON CITY CONN	3,000.00 2,000.00 1,000.00
1516392	06/17/2021	86886	SOUTH UNION MISSIONARY BAPTIST CITY OF HOUSTON CITY CONN	1,000.00
1516486	06/24/2021	83827	ASSOCIATION FOR THE ADVANCEMENT OF CITY OF HOUSTON CITY CONN	945.33

# Check Register

Fiscal Year: 21      Period: 10

**Fund: 4671 - LOC-CITY OF HOUSTON**

<u>check number</u>	<u>check date</u>	<u>vend no</u>	<u>vendor name and item descriptions</u>	<u>amount</u>
1516490	06/24/2021	11215	ALLIANCE MULTICULTURAL COMMUN SVCS CITY OF HOUSTON CITY CONN	1,000.00
1516496	06/24/2021	19150	CHILDRENS MUSEUM, INC CITY OF HOUSTON CITY CONN	2,000.00
1516501	06/24/2021	87846	DIAZ MUSIC INSTITUTE CITY OF HOUSTON CITY CONN	1,870.44
1516504	06/24/2021	24788	THE ENSEMBLE THEATRE CITY OF HOUSTON CITY CONN CITY OF HOUSTON CITY CONN	5,000.00 1,000.00 4,000.00
1516505	06/24/2021	86782	EVELYN RUBENSTEIN JEWISH COMMUNITY CITY OF HOUSTON CITY CONN	2,000.00
1516507	06/24/2021	86443	FAMILY POINT RESOURCES CITY OF HOUSTON CITY CONN	2,000.00
1516510	06/24/2021	23615	FOTOFEST INC CITY OF HOUSTON CITY CONN	1,000.00
1516520	06/24/2021	88676	HOUSTON HURRICANE LACROSSE CLUB CITY OF HOUSTON CITY CONN	5,000.00
1516521	06/24/2021	80428	HOUSTON MARATHON FOUNDATION CITY OF HOUSTON CITY CONN	1,000.00
1516523	06/24/2021	87845	IMPACTING HOUSTON INC CITY OF HOUSTON CITY CONN	11,857.97
1516531	06/24/2021	85132	MULTICULTURAL EDUCATION AND CITY OF HOUSTON CITY CONN	1,000.00
1516538	06/24/2021	88673	RETRAIN AMERICA CITY OF HOUSTON CITY CONN	1,500.00
1516544	06/24/2021	84089	THE WOODS PROJECT INC. CITY OF HOUSTON CITY CONN	2,000.00
1516549	06/24/2021	87063	VILLAGE LEARNING CENTER INC CITY OF HOUSTON CITY CONN	2,000.00
1516554	06/24/2021	64735	YMCA CITY OF HOUSTON CITY CONN	2,000.00
1516555	06/24/2021	87221	YOUNG WOMENS CHRISTIAN ASSOCIATION CITY OF HOUSTON CITY CONN	1,000.00
V1516186	06/04/2021	87018	COLOR OF LIFE COMMUNITY RESOURCE & CITY OF HOUSTON CITY CONN	1,000.00
V1516229	06/04/2021	85551	PARTNERSHIP FOR THE ADVANCEMENT & CITY OF HOUSTON CITY CONN	1,000.00
V1516420	06/17/2021	87193	COMP-U-DOPT INC CITY OF HOUSTON CITY CONN	2,000.00
V1516558	06/24/2021	87305	BRIDGING THE DIGITAL DIVIDE CITY OF HOUSTON CITY CONN CITY OF HOUSTON CITY CONN	5,000.00 1,000.00 4,000.00
V1516559	06/24/2021	17320	BUTLER BUSINESS PRODUCTS TRIPP LITE 6FT DVI DUAL L TRIPP LITE 6FT DVI DUAL L TRIPP LITE USB-C DOCKING C2G 6FT VGA CABLE - SELEC KENSINGTON DISPLAYPORT TO TRIPP LITE USB-C DOCKING KENSINGTON DISPLAYPORT TO TRIPP LITE 6IN MINI DISPL TRIPP LITE DISPLAYPORT TO	1,499.45 24.48 97.92 394.52 112.60 240.35 197.26 48.07 321.60 62.65



# Check Register

Fiscal Year: 21      Period: 10

**Fund: 4671 - LOC-CITY OF HOUSTON**

<u>check number</u>	<u>check date</u>	<u>vend no</u>	<u>vendor name and item descriptions</u>	<u>amount</u>
V1516580	06/24/2021	87550	MUFASAS PRIDE RITES OF PASSAGE CITY OF HOUSTON CITY CONN	3,000.00 2,000.00
V1516582	06/24/2021	85551	CITY OF HOUSTON CITY CONN PARTNERSHIP FOR THE ADVANCEMENT & CITY OF HOUSTON CITY CONN	1,000.00 1,600.00
V1516591	06/24/2021	88415	STEM WITH AN URBAN PERSPECTIVE CITY OF HOUSTON CITY CONN CITY OF HOUSTON CITY CONN	3,000.00 1,000.00 2,000.00

Number of checks in fund 4671 - LOC-CITY OF HOUSTON: **58**      Amount total: **129,743.44**

**Fund: 4681 - COUNTY CONNECTION PROGRAM**

<u>check number</u>	<u>check date</u>	<u>vend no</u>	<u>vendor name and item descriptions</u>	<u>amount</u>
1516264	06/10/2021	88574	EXECU TEAM STAFFING EXCELLENT EXCEL SKILLS, D	911.65
1516506	06/24/2021	88574	EXECU TEAM STAFFING EXCELLENT EXCEL SKILLS, D EXCELLENT EXCEL SKILLS, D EXCELLENT EXCEL SKILLS, D	2,181.88 729.32 729.32 723.24

Number of checks in fund 4681 - COUNTY CONNECTION PROGRAM: **2**      Amount total: **3,093.53**

**Fund: 4961 - LOC-HOGG FOUNDATION-YR 2**

<u>check number</u>	<u>check date</u>	<u>vend no</u>	<u>vendor name and item descriptions</u>	<u>amount</u>
1516385	06/17/2021	88434	LAVONDIA A MENEPHEE WILL PROVIDE 2 TRAININGS	2,000.00

Number of checks in fund 4961 - LOC-HOGG FOUNDATION-YR 2: **1**      Amount total: **2,000.00**

**Fund: 4981 - LOC-OTHER LOCAL GRANTS**

<u>check number</u>	<u>check date</u>	<u>vend no</u>	<u>vendor name and item descriptions</u>	<u>amount</u>
1516148	06/04/2021	88587	AUNDREY MOSLEY DBA PROVIDE SUBJECT MATTER EX	4,125.00
1516164	06/04/2021	88445	YAWP RECORDS LLC SPRING 2021 PROVIDER WILL	2,750.00
1516252	06/10/2021	88593	RUSSELL A BARKLEY PHD SPEAKER AGREEMENT TO PRES	10,700.00

Number of checks in fund 4981 - LOC-OTHER LOCAL GRANTS: **3**      Amount total: **17,575.00**

**Fund: 6941 - CAPITAL PROJECTS - PFC**

<u>check number</u>	<u>check date</u>	<u>vend no</u>	<u>vendor name and item descriptions</u>	<u>amount</u>
1516500	06/24/2021	81367	CRE8 INCORPORATED ARCHITECTURAL & ENGINEERI	146,939.01
1516503	06/24/2021	88648	ENGLISH + ASSOCIATES ARCHITECTS INC ARCHITECTURAL & ENGINEERI ARCHITECTURAL & ENGINEERI ARCHITECTURAL & ENGINEERI	106,540.23 2,364.18 70,722.50 33,453.55
V1516336	06/10/2021	88484	LOCKWOOD, ANDREWS & NEWNAM INC HIGHPOINT EAST RENOVATION IRVINGTON MISC. EXPENDITU HP EAST MISC. EXPENDITURE NEW ADULT ED BUILDING MIS IRVINGTON RENOVATION NEW ADULT EDUCATION	50,277.91 11,464.37 24.75 23.42 54.31 12,114.49 26,596.57

# Check Register

Fiscal Year: 21      Period: 10

Number of checks in fund 6941 - CAPITAL PROJECTS - PFC: 3

Amount total: **303,757.15**

**Fund: 6961 - LA PORTE HS CONSTRUCTION**

<u>check number</u>	<u>check date</u>	<u>vend_no</u>	<u>vendor name and item descriptions</u>	<u>amount</u>
1516386	06/17/2021	88594	NASH INDUSTRIES INC RENOVATIONS TO THE EXISTI	71,169.62

Number of checks in fund 6961 - LA PORTE HS CONSTRUCTION: 1

Amount total: **71,169.62**

**Fund: 7111 - CHOICE PARTNERS**

<u>check number</u>	<u>check date</u>	<u>vend_no</u>	<u>vendor name and item descriptions</u>	<u>amount</u>
1516167	06/04/2021	84787	ZACHRY PUBLICATIONS, LP PRINT ADVERTISING IN TEXA	1,100.00
1516281	06/10/2021	84028	ION WAVE TECHNOLOGIES, INC. IONWAVE TECHNOLOGIES AMEN	2,500.00
1516314	06/10/2021	61927	VERIZON WIRELESS VERIZON 050821-060721	310.41
1516317	06/10/2021	87489	DAHILL OFFICE TECHNOLOGY CORP MAY2021 LEASE	149.84
1516512	06/24/2021	29505	HALLMARK OFFICE PRODUCTS INC HON FILE/FILE PEDESTAL HON BOX/BOX/FILE PEDESTAL HON BOX/BOX/FILE PEDESTAL HON FILE/FILE PEDESTAL HON FILE/FILE PEDESTAL	7,355.70 1,634.60 1,634.60 1,225.95 1,634.60 1,225.95
1516516	06/24/2021	32350	HOUSTON CHRONICLE ADVERTISING RFPS IN THE H	348.98
1516535	06/24/2021	88836	SHANDRA YVETTE POWELL TASBO 2021 SUMMER SOL	110.00
1516546	06/24/2021	60940	UNITED PARCEL SERVICE POSTAGE	11.46
1516553	06/24/2021	87489	DAHILL OFFICE TECHNOLOGY CORP JUNE21 LEASE	149.84
1516556	06/24/2021	84787	ZACHRY PUBLICATIONS, LP PRINT ADVERTISING IN TEXA	1,100.00
V1516182	06/04/2021	17320	BUTLER BUSINESS PRODUCTS BLACK MASK SET UP CHARGE FRIEGHT VACCINATION CARD HOLDER O ROYAL BLUE MASK	4,427.00 1,925.00 60.00 47.00 470.00 1,925.00
V1516198	06/04/2021	87910	ANN MARIE HARBOUR FI8ELD REPRESENTATIVE REI FIELD REPRESENTATIVE DAIL	1,433.60 33.60 1,400.00
V1516329	06/10/2021	87910	ANN MARIE HARBOUR FI8ELD REPRESENTATIVE REI FIELD REPRESENTATIVE DAIL	1,103.94 53.94 1,050.00
V1516414	06/17/2021	17320	BUTLER BUSINESS PRODUCTS G2 RETRACTABLE GEL PENS W BUSINESS SOURCE REPOSITIO TOPS PRISM PLUS LEGAL PAD TOPS CLASSFIED BUSINESS N SCOTCH PERMANENT DOUBLE-S PENTAL OF AMERICA, LTD; P CANON LS82Z HANDHELP CALC POST-IT DURABLE TABS - PR	214.52 63.19 9.62 12.20 72.54 12.46 31.05 9.00 4.46

# Check Register

Fiscal Year: 21      Period: 10

**Fund: 7111 - CHOICE PARTNERS**

<u>check number</u>	<u>check date</u>	<u>vend no</u>	<u>vendor name and item descriptions</u>	<u>amount</u>
V1516435	06/17/2021	87910	ANN MARIE HARBOUR FI8ELD REPRESENTATIVE REI	1,222.60 172.60
V1516559	06/24/2021	17320	BUTLER BUSINESS PRODUCTS ESTIMATED SHIPPING/HANDLI DEBOSSSED MICROFIBER CLOTH SET UP FEE	1,050.00 1,520.00 70.00 1,360.00 90.00

Number of checks in fund 7111 - CHOICE PARTNERS: **16**

Amount total: **23,057.89**

**Fund: 7991 - ISF-FACILITIES**

<u>check number</u>	<u>check date</u>	<u>vend no</u>	<u>vendor name and item descriptions</u>	<u>amount</u>
1516102	06/04/2021	87542	ALWAYS IN SEASON, INC APR21PLANT MAINTANCE	266.66
1516125	06/04/2021	88399	FRANCOTYP-POSTALIA INC MONTHLY POSTAGE MACHINE F	621.00
1516129	06/04/2021	85932	EMCOR GOWAN INC REPLACE PIPING AT WATER H	6,805.00

# Check Register

Fiscal Year: 21      Period: 10

**Fund: 7991 - ISF-FACILITIES**

<u>check number</u>	<u>check date</u>	<u>vend no</u>	<u>vendor name and item descriptions</u>	<u>amount</u>
1516146	06/04/2021	82060	METROPOLITAN LANDSCAPE MGMT INC	21,396.48
			MAY21 MAINTENANCE	94.95
			MAY21 MAINTENANCE	119.88
			MAY21 MAINTENANCE	157.50
			MAY21 MAINTENANCE	679.35
			MAY21 MAINTENANCE	346.50
			MAY21 MAINTENANCE	1,133.00
			APR21 MAINTENANCE	94.95
			APR21 MAINTENANCE	689.15
			APR21 MAINTENANCE	228.20
			APR21 MAINTENANCE	222.95
			APR21 MAINTENANCE	156.63
			APR21 MAINTENANCE	467.25
			APR21 MAINTENANCE	240.83
			APR21 MAINTENANCE	785.83
			APR21 MAINTENANCE	820.83
			APR21 MAINTENANCE	190.00
			MAY21 MAINTENANCE	689.15
			MAY21 MAINTENANCE	456.40
			MAY21 MAINTENANCE	119.88
			MAY21 MAINTENANCE	119.88
			MAY21 MAINTENANCE	222.95
			MAY21 MAINTENANCE	156.63
			MAY21 MAINTENANCE	785.83
			MAY21 MAINTENANCE	190.00
			APR21 MAINTENANCE	456.40
			APR21 MAINTENANCE	820.58
			APR21 MAINTENANCE	119.88
			APR21 MAINTENANCE	679.35
			APR21 MAINTENANCE	103.25
			APR21 MAINTENANCE	206.50
			APR21 MAINTENANCE	1,133.00
			MAY21 MAINTENANCE	228.20
			MAY21 MAINTENANCE	228.20
			MAY21 MAINTENANCE	820.58
			MAY21 MAINTENANCE	237.29
			MAY21 MAINTENANCE	103.25
			MAY21 MAINTENANCE	119.88
			MAY21 MAINTENANCE	206.50
			APR21 MAINTENANCE	123.38
			APR21 MAINTENANCE	119.88
			APR21 MAINTENANCE	679.35
			APR21 MAINTENANCE	119.88
			MAY21 MAINTENANCE	995.05
			MAY21 MAINTENANCE	123.38
			MAY21 MAINTENANCE	679.35
			MAY21 MAINTENANCE	155.75
			MAY21 MAINTENANCE	467.25
			MAY21 MAINTENANCE	240.83
			MAY21 MAINTENANCE	820.83
			APR21 MAINTENANCE	228.20
			APR21 MAINTENANCE	995.05
			APR21 MAINTENANCE	157.50

# Check Register

Fiscal Year: 21      Period: 10

**Fund: 7991 - ISF-FACILITIES**

<u>check number</u>	<u>check date</u>	<u>vend no</u>	<u>vendor name and item descriptions</u>	<u>amount</u>
1516146	06/04/2021	82060	METROPOLITAN LANDSCAPE MGMT INC	21,396.48
			APR21 MAINTENANCE	346.50
			APR21 MAINTENANCE	155.75
			APR21 MAINTENANCE	237.29
			APR21 MAINTENANCE	119.88
1516158	06/04/2021	60940	UNITED PARCEL SERVICE	15.45
			POSTAGE	
1516259	06/10/2021	18491	CENTERPOINT ENERGY	1,716.99
			GAS 042721-052521	21.86
			GAS 042721-052521	23.67
			GAS 042721-052521	1,671.46
1516272	06/10/2021	85932	EMCOR GOWAN INC	2,766.00
			VACUUM SEPTIC TANK	
1516274	06/10/2021	29829	HARRIS COUNTY MUD #5	225.50
			WATER 041821-051921	
1516278	06/10/2021	33040	CITY OF HOUSTON WATER	4,474.22
			WATER 041921-051921	16.69
			WATER 041921-051721	16.69
			WATER 041921-051921	122.26
			WATER 042621-052521	165.03
			WATER 041921-052721	24.31
			WATER 041921-051921	49.71
			WATER 041921-051921	1,689.76
			WATER 041221-051821	468.48
			WATER 041921-051921	599.82
			WATER 042121-052121	28.22
			WATER 041821-051621	30.10
			WATER 042621-052521	1,263.15
1516286	06/10/2021	88033	LETSOS COMPANY	3,721.18
			BROKEN PIPE	2,749.98
			REPAIR WATER LEAKS	971.20
1516299	06/10/2021	50335	ROYALWOOD MUD	303.60
			WATER 041521-051821	69.24
			WATER 041521-051821	72.20
			WATER 041521-051821	81.08
			WATER 041521-051821	81.08
1516304	06/10/2021	53060	SATCO SERVICE INC	936.00
			FOR THE MONTHLY SWEEPING	438.00
			FOR THE MONTHLY SWEEPING	249.00
			FOR THE MONTHLY SWEEPING	249.00
1516309	06/10/2021	88303	VISTRA PREFERRED INC	3,656.94
			ELECT061721-041421	4.68
			ELECT061721-041421	4.68
			ELECT 031121-040821	40.79
			ELECT061721-041421	299.51
			ELECT061721-041421	3,307.28

# Check Register

Fiscal Year: 21      Period: 10

**Fund: 7991 - ISF-FACILITIES**

<u>check number</u>	<u>check date</u>	<u>vend no</u>	<u>vendor name and item descriptions</u>	<u>amount</u>
1516314	06/10/2021	61927	VERIZON WIRELESS	3,833.21
			VERIZON 050821-060721	114.33
			VERIZON 050821-060721	131.20
			VERIZON 050821-060721	142.76
			VERIZON 050821-060721	1,983.56
			VERIZON 050821-060721	38.11
			VERIZON 050821-060721	85.75
			VERIZON 050821-060721	1,119.20
			VERIZON 050821-060721	49.02
			VERIZON 050821-060721	169.28
1516317	06/10/2021	87489	DAHILL OFFICE TECHNOLOGY CORP	200.42
			MAY2021 LEASE	25.29
			MAY2021 LEASE	25.29
			MAY2021 LEASE	149.84
1516361	06/17/2021	87542	ALWAYS IN SEASON, INC	483.01
			JUN21 PLANT MAINTEN	266.66
			JUN21 PLANT MAINTEN	153.71
			JUN21 PLANT MAINTEN	62.64
1516369	06/17/2021	18491	CENTERPOINT ENERGY	45.14
			GAS 042921-052721	
1516376	06/17/2021	26235	FOSTER FENCE LTD	4,780.00
			REPLACE THE EXISTING GATE	
1516379	06/17/2021	33040	CITY OF HOUSTON WATER	197.88
			WATER 042921-052821	
1516394	06/17/2021	86778	UNITED RENTALS (NORTH AMERICA) INC	7,600.00
			RENTAL OF 2 RESTROOM TRAI	
1516397	06/17/2021	62751	WASTE MANAGEMENT	1,757.39
			MAY 21 WASTE DISPOSAL	168.87
			MAY 21 WASTE DIPOSAL	112.58
			MAY 21 WASTE DIPOSAL`	253.31
			MAY 21 WASTE DISPOSAL	562.90
			MAY 21 WASTE DIPOSAL	168.87
			MAY 21 WASTE DISPOSAL	234.17
			MAY 21 WASTE DIPOSAL	168.87
			JUN 21 WASTE DISPOSAL	87.82
1516495	06/24/2021	18491	CENTERPOINT ENERGY	133.06
			GAS 050721-060821	21.86
			GAS 050521-060721	25.68
			GAS 051021-060921	85.52
1516517	06/24/2021	33040	CITY OF HOUSTON WATER	605.64
			WATER 061521	230.52
			WATER 0614	356.45
			WATER 051721-061421	18.67
1516536	06/24/2021	88760	POWERSECURE INC	3,144.58
			REPLACE THE ENGINE COOLAN	
1516545	06/24/2021	59870	THYSSENKRUPP ELEVATOR CORP	2,894.72
			MAINTENANCE ON THE ELEVAT	255.92
			MAINTENANCE AGREEMENT/SER	358.22
			MAINTENANCE ON THE ELEVAT	1,397.97
			MAINTENANCE ON THE ELEVAT	275.62
			MAINTENANCE ON THE ELEVAT	606.99

# Check Register

Fiscal Year: 21

Period: 10

**Fund: 7991 - ISF-FACILITIES**

<u>check number</u>	<u>check date</u>	<u>vend no</u>	<u>vendor name and item descriptions</u>	<u>amount</u>
1516546	06/24/2021	60940	UNITED PARCEL SERVICE	30.00
			POSTAGE	14.55
			POSTAGE	15.45
1516550	06/24/2021	62751	WASTE MANAGEMENT	562.90
			JUNE21 TRASH PICK-UP	
1516553	06/24/2021	87489	DAHILL OFFICE TECHNOLOGY CORP	200.42
			JUNE21 LEASE	149.84
			JUNE21 LEASE	25.29
			JUNE21 LEASE	25.29
V1516182	06/04/2021	17320	BUTLER BUSINESS PRODUCTS	673.07
			BATTERY, ALKA, INDUST, AA	257.52
			BATTERY, ALKA, INDUST, AA	415.55

# Check Register

Fiscal Year: 21      Period: 10

**Fund: 7991 - ISF-FACILITIES**

<u>check number</u>	<u>check date</u>	<u>vend no</u>	<u>vendor name and item descriptions</u>	<u>amount</u>
V1516203	06/04/2021	31720	COPESAN SERVICES INC	5,023.99
			PA2021-0690 EXTERIOR	40.00
			PA2021-0690 MOSQUITO	181.00
			MONTHLY PEST CONTROL SERV	26.00
			MONTHLY PEST CONTROL SERV	26.00
			MONTHLY PEST CONTROL SERV	41.50
			MONTHLY PEST CONTROL SERV	41.50
			MONTHLY PEST CONTROL SERV	30.00
			MONTHLY PEST CONTROL SERV	30.00
			MONTHLY PEST CONTROL SERV	31.25
			MONTHLY PEST CONTROL SERV	31.25
			MONTHLY PEST CONTROL SERV	77.25
			ADDITIONAL PEST CONTROL W	46.75
			ADDITIONAL PEST CONTROL W	20.00
			ADDITIONAL PEST CONTROL W	30.00
			ADDITIONAL PEST CONTROL W	31.24
			ADDITIONAL PEST CONTROL W	46.75
			PA2021-0690 BED BUG	1,950.00
			MONTHLY PEST CONTROL SERV	15.75
			MONTHLY PEST CONTROL SERV	15.75
			MONTHLY PEST CONTROL SERV	36.25
			MONTHLY PEST CONTROL SERV	66.00
			MONTHLY PEST CONTROL SERV	35.00
			MONTHLY PEST CONTROL SERV	125.00
			MONTHLY PEST CONTROL AT L	41.50
			MONTHLY PEST CONTROL AT B	65.00
			MONTHLY PEST CONTROL AT S	60.00
			ADDITIONAL PEST CONTROL W	20.00
			MONTHLY PEST CONTROL SERV	46.75
			MONTHLY PEST CONTROL SERV	46.75
			MONTHLY PEST CONTROL SERV	15.75
			MONTHLY PEST CONTROL SERV	41.50
			MONTHLY PEST CONTROL SERV	41.50
			MONTHLY PEST CONTROL SERV	36.25
			MONTHLY PEST CONTROL SERV	232.75
			MONTHLY PEST CONTROL SERV	63.25
			MONTHLY PEST CONTROL SERV	63.25
			MONTHLY PEST CONTROL AT S	41.50
			MONTHLY PEST CONTROL AT S	60.00
			PA2021-0690 GMATS IN	450.00
			MONTHLY PEST CONTROL SERV	15.75
			MONTHLY PEST CONTROL SERV	60.00
			MONTHLY PEST CONTROL SERV	66.00
			MONTHLY PEST CONTROL SERV	35.00
			MONTHLY PEST CONTROL SERV	60.00
			MONTHLY PEST CONTROL SERV	77.25
			ADDITIONAL PEST CONTROL W	165.00
			MONTHLY PEST CONTROL AT T	165.00
			ADDITIONAL PEST CONTROL W	20.00
			ADDITIONAL PEST CONTROL W	60.00
V1516232	06/04/2021	47923	QSS, L.C	2,468.87
			REPLACE IP VIDEO MASTER S	



# Check Register

Fiscal Year: 21      Period: 10

**Fund: 7991 - ISF-FACILITIES**

<u>check number</u>	<u>check date</u>	<u>vend no</u>	<u>vendor name and item descriptions</u>	<u>amount</u>
V1516236	06/04/2021	84863	COLOR ONE SYSTEMS	138.00
			BUSINESS CARDS FOR JULIE	46.00
			BUSINESS CARDS FOR ANDREA	92.00
V1516325	06/10/2021	17320	BUTLER BUSINESS PRODUCTS	630.41
			COFFEE PRODUCTS	595.28
			COFFEE PRODUCTS	35.13
V1516331	06/10/2021	31720	COPELAN SERVICES INC	345.75
			MONTHLY PEST CONTROL SERV	57.00
			ADDITIONAL PEST CONTROL W	118.00
			MONTHLY PEST CONTROL AT	49.25
			MONTHLY PEST CONTROL AT C	41.50
			ADDITIONAL PEST CONTROL W	20.00
			ADDITIONAL PEST CONTROL W	60.00
V1516337	06/10/2021	46604	THOMAS W PLAPP	101.92
			MAY MILEAGE	
V1516339	06/10/2021	47923	QSS, L.C	7,271.93
			MONTHLY MONITORING SERVIC	1,672.08
			MONTHLY MONITORING SERVIC	271.30
			MONTHLY MONITORING SERVIC	210.76
			MONTHLY MONITORING SERVIC	344.95
			MONTHLY MONITORING SERVIC	442.66
			MONTHLY MONITORING SERVIC	393.60
			MONTHLY MONITORING SERVIC	170.64
			MONTHLY MONITORING SERVIC	411.78
			MONTHLY MONITORING SERVIC	1,540.94
			MONTHLY MONITORING SERVIC	407.24
			MONTHLY MONITORING SERVIC	551.78
			MONTHLY MONITORING SERVIC	353.91
			MONTHLY MONITORING SERVIC	203.26
			MONTHLY MONITORING SERVIC	297.03
V1516429	06/17/2021	85264	EXECUTIVE THREAT SOLUTIONS LLC	27,888.00
			FOR ON-SITE SECURITY FOR	4,320.00
			FOR ON-SITE SECURITY FOR	4,800.00
			FOR ON-SITE SECURITY FOR	4,224.00
			FOR ON-SITE SECURITY FOR	4,776.00
			FOR ON-SITE SECURITY FOR	4,968.00
			FOR ON-SITE SECURITY FOR	4,800.00
V1516431	06/17/2021	83350	WRIGHT EXPRESS FINANCIAL SVC CORP	1,763.92
			GAS MAY 2021	
V1516474	06/17/2021	84446	ALBERT V VALADEZ	257.43
			MAY MILEAGE	
V1516559	06/24/2021	17320	BUTLER BUSINESS PRODUCTS	541.55
			COFFEE PRODUCTS	476.78
			COFFEE PRODUCTS	64.77

# Check Register

Fiscal Year: 21      Period: 10

**Fund: 7991 - ISF-FACILITIES**

<u>check number</u>	<u>check date</u>	<u>vend no</u>	<u>vendor name and item descriptions</u>	<u>amount</u>
V1516570	06/24/2021	31720	COPESAN SERVICES INC	1,698.15
			MONTHLY PEST CONTROL SERV	26.00
			MONTHLY PEST CONTROL SERV	26.00
			MONTHLY PEST CONTROL SERV	26.00
			MONTHLY PEST CONTROL SERV	67.25
			MONTHLY PEST CONTROL SERV	77.75
			MONTHLY PEST CONTROL AT B	65.00
			MONTHLY PEST CONTROL AT J	41.50
			MONTHLY PEST CONTROL AT J	60.00
			MONTHLY PEST CONTROL AT L	41.50
			MONTHLY PEST CONTROL SERV	31.24
			MONTHLY PEST CONTROL SERV	36.25
			MONTHLY PEST CONTROL AT	49.25
			MONTHLY PEST CONTROL AT T	48.71
			ADDITIONAL PEST CONTROL W	46.75
			ADDITIONAL PEST CONTROL W	118.00
			MONTHLY PEST CONTROL AT P	220.00
			MONTHLY PEST CONTROL AT S	41.50
			MONTHLY PEST CONTROL SERV	57.00
			MONTHLY PEST CONTROL SERV	15.75
			MONTHLY PEST CONTROL SERV	31.25
			MONTHLY PEST CONTROL SERV	40.00
			MONTHLY PEST CONTROL AT B	41.50
			MONTHLY PEST CONTROL AT T	30.00
			MONTHLY PEST CONTROL SERV	26.00
			MONTHLY PEST CONTROL SERV	15.75
			MONTHLY PEST CONTROL AT B	65.00
			MONTHLY PEST CONTROL AT F	41.50
			MONTHLY PEST CONTROL AT	48.71
			MONTHLY PEST CONTROL AT P	31.24
			MONTHLY PEST CONTROL AT P	46.75
			ADDITIONAL PEST CONTROL W	20.00
			ADDITIONAL PEST CONTROL W	165.00
V1516583	06/24/2021	47923	QSS, L.C	246.82
			PA2021-0734 MAINTENAN	
V1516590	06/24/2021	53379	DS WATERS OF AMERICA INC	311.67
			MONTHLY WATER SERVICE FOR	212.16
			MONTHLY WATER SERVICE FOR	99.51

Number of checks in fund 7991 - ISF-FACILITIES: <b>43</b>	Amount total:	<b>122,734.87</b>
Total number of checks in report: <b>494</b>	Amount total:	<b>2,533,856.27</b>

HARRIS COUNTY DEPARTMENT OF EDUCATION  
 CHECK REGISTER INCLUDING SYSTEM VOIDS

SELECTION CRITERIA: chkstat.rundate between '20210601 00:00:00.000' and '20210629 00:00:00.000' and chkstat.chk\_status='v'

DISTRIBUTION FUND: 1991

CHECK NUMBER	ISSUE DATE	VENDOR	STATUS	TOTAL	DESCRIPTION
1516058	06/01/2021	SIMON T BAILY INTERNATIONAL INC	V	-1590.00	VOID MANUAL CHECK
* 1516313	06/10/2021	VERIZON WIRELESS	V	0.00	VOID: MULTI STUB CHECK
*V1515736	06/14/2021	MILK PRODUCTS LLC	V	-1273.86	VOID MANUAL CHECK
*V1515866	06/14/2021	MILK PRODUCTS LLC	V	-1008.33	VOID MANUAL CHECK
*V1515997	06/14/2021	MILK PRODUCTS LLC	V	-1456.09	VOID MANUAL CHECK
*V1516176	06/04/2021	MILK PRODUCTS LLC	V	0.00	VOID: MULTI STUB VOUCHER
*V1516177	06/04/2021	MILK PRODUCTS LLC	V	0.00	VOID: MULTI STUB VOUCHER
*V1516178	06/14/2021	MILK PRODUCTS LLC	V	-2065.95	VOID MANUAL CHECK
*V1516201	06/04/2021	COPELAN SERVICES INC	V	0.00	VOID: MULTI STUB VOUCHER
*V1516202	06/04/2021	COPELAN SERVICES INC	V	0.00	VOID: MULTI STUB VOUCHER
*V1516406	06/17/2021	MILK PRODUCTS LLC	V	0.00	VOID: MULTI STUB VOUCHER
*V1516407	06/17/2021	MILK PRODUCTS LLC	V	0.00	VOID: MULTI STUB VOUCHER
*V1516408	06/17/2021	MILK PRODUCTS LLC	V	0.00	VOID: MULTI STUB VOUCHER
*V1516409	06/17/2021	MILK PRODUCTS LLC	V	0.00	VOID: MULTI STUB VOUCHER
*V1516410	06/17/2021	MILK PRODUCTS LLC	V	0.00	VOID: MULTI STUB VOUCHER
*V1516569	06/24/2021	COPELAN SERVICES INC	V	0.00	VOID: MULTI STUB VOUCHER
TOTAL FUND				-7394.23	
TOTAL REPORT				-7394.23	

# FUND SUMMARY FOR BOARD CHECK REGISTER

Fiscal Year: 21 Period: 10

<u>fund starts with</u>	<u>sum of checks</u>	<u>check count</u>
1	701,838.20	251
2	1,158,886.57	165
4	152,411.97	64
6	374,926.77	4
7	145,792.76	53
<hr/>		
Total:	2,533,856.27	494

**Regular Board Meeting**

**8.A.2.**

**Meeting Date:** July 21, 2021

**Title:** Budget Amendment Report

**Submitted For:** Jesus Amezcua, Business Office

**Submitted By:** Stephanie Ritchie

**Additional Resource**

**Personnel:**

---

**Information**

**Posted Agenda Item:**

Monthly Budget Amendment Report

**Subject:**

Budget Amendment Report for July 2021

**Rationale:**

Amendments that increase/decrease a program budget must be approved by the board.

---

**Attachments**

*No file(s) attached.*

---

**Form Review**

**Inbox**

Assistant Superintendent - Business

Form Started By: Stephanie Ritchie

Final Approval Date: 06/28/2021

**Reviewed By**

Jesus Amezcua

**Date**

06/28/2021 02:13 PM

Started On: 06/24/2021 10:24 AM

**Regular Board Meeting**

**8.A.3.**

**Meeting Date:** July 21, 2021

**Title:** Approval of Investment Report

**Submitted For:** Jesus Amezcua, Business Office      **Submitted By:** Stephanie Ritchie

**Additional Resource Personnel:**

**Information**

**Posted Agenda Item:**

Monthly Investment Report for June 2021

**Subject:**

Consider approval of Investment report dated June 2021

**Rationale:**

In accordance with Texas Government Code, Section 2256, Public Funds Investment Act, HCDE has adopted written investment policy, CDA (LEGAL) and CDA (LOCAL) Other Revenues: Investments requiring the investment officers to prepare and submit a written report of investment transactions for the preceding reporting period to the Board of Trustees.

The attached report is for the time period June 2021.

**Attachments**

Monthly Investment Report

**Form Review**

**Inbox**

Assistant Superintendent - Business  
Form Started By: Stephanie Ritchie  
Final Approval Date: 06/28/2021

**Reviewed By**

Jesus Amezcua

**Date**

06/28/2021 02:13 PM  
Started On: 06/24/2021 10:24 AM

**HARRIS COUNTY DEPARTMENT OF EDUCATION  
And  
HCDE PUBLIC FACILITY CORPORATION**

**Monthly Investment Report as of June 30, 2021  
(unaudited)**

**Table of Contents**

DESCRIPTION	SCHEDULE NO.
Compliance Statement .....	1
<b>General Funds:</b>	
<i>Pie Chart: <u>Portfolio by Investment Type</u></i> .....	2
<i>Summary Schedule of Weighted Average Maturity-by Investment Type</i> .....	3
<i>Graph: <u>Portfolio by Maturity Dates</u></i> .....	4
Investment Earnings Reports: .....	5
(A) Interest Earned by Fund by Source-For This Quarter	
(B) Interest Earned by Fund-Comparison of Quarters for FY 2020-21	
(C) Budget v Actual Summary of Interest Earned Year-to-Date	
<i>Schedule: <u>Summary Report</u></i> .....	6
<i>Schedule: <u>Monthly Inventory Report</u></i> .....	7
<b>Public Facility Corporation:</b>	
<i>Pie Chart: <u>Portfolio by Investment Type</u></i> .....	8
<i>Graph: <u>Portfolio by Maturity Dates</u></i> .....	9
<i>Schedule: <u>Monthly Inventory Report</u></i> .....	10
Bank Accounts .....	11
Monthly Investment Reports: .....	12
(1) Interest Earned by Fund by Source-For This Quarter	
(2) Interest Earned by Fund-Comparison of Quarters during FY 2020-21	
(3) Budget Summary for Interest Earned Year-to-Date	
Glossary of Terms .....	13
Detail Account Statements available for review:	
Lone Star Investment Pool Monthly Report	
TexPool Participant Monthly Statement	
Tex STAR Monthly Statement of Accounts	
Texas Class Monthly Statement	
Chase Bank-Sweep Account Monthly Statements	
Chase Bank-Investment Safekeeping Account Monthly Statements	
PFC – Bank of Texas Fund Monthly Statements	

## **Investment Report Narrative**

The Department's funds are required to be deposited and invested under the terms of a depository contract pursuant to the Texas School Depository Act and local Board Policy. The depository bank pledges securities which comply with state law and these securities are held for safekeeping and trust with the Department's and the depository bank's agent bank.

HCDE funds are currently invested in investment pools and with the depository bank. The investment pools used are: Lone Star, Tex Pool, Texas Class and TexStar. The depository bank is J.P. Morgan Chase.

Changes in balances are caused by additions or withdrawals to these accounts. Tax collection deposits are automatically deposited to the TexStar account.

The Public Facility Corporation (PFC) funds are invested with Bank of Texas, Tex-Pools and J. P. Morgan Chase. These funds are reserved as required by the bond covenant.

All funds are properly collateralized according the PFIA (Public Funds Investment Act).

All funds are invested overnight to capture rising interest rates

Book Value = Market Value. Book value refers to the financial institution statement which is reconciled to the general ledger.

### **Moving Forward**

The department will continue to monitor its investments and find best value to capture additional interest earnings while preserving the capital in accordance with our adopted investment strategy.



### **Compliance Statement**

In accordance with Texas Government Code, Section 2256, Public Funds Investment Act, HCDE has adopted written investment policy, CDA (LEGAL) and CDA (LOCAL) Other Revenues: Investments requiring the investment officers to prepare and submit a written report of investment transactions for the preceding reporting period to the Board of Trustees. The report must be prepared at least on a Monthly basis and must:

- Describe in detail the investment position of HCDE on the date of the report.
- Contain a summary statement of each pooled fund group including beginning market value for the reporting period; additions and changes to the market value during the period and ending market value for the period.
- State the book value and market value of each invested asset at the beginning and end of the reporting period by type of asset and fund type invested.
- State the account, fund or pooled fund group for which each asset was acquired.
- State compliance of the investment portfolio with the HCDE investment policy and investment strategies and with state law.

HCDE follows the Public Funds Investment Act. All investments purchased must meet the three basic tenets included in the investment policy: safety, liquidity, and yield.

The day-to-day cash management and HCDE investments are the responsibility of the Asst. Superintendent, Chief Accounting Officer, Budget & Business Analyst, and the Senior Accountant.

As the approved investment officer of Harris County Department of Education, I hereby certify that the preceding Investment Report represents the investment position of the Department as of the date above in compliance with the Board-approved Investment Policy, the Public Funds Investment Act, and generally accepted accounting principles.

*/s/ Jesus J. Amezcua*

---

Jesus J. Amezcua, RTSBA, CPA, Ph.D., Asst. Supt-Business

---

Vacant, CPA Chief Accounting Officer

*/s/ Stephanie Hardin*

---

Stephanie Hardin, Senior Accountant

*/s/ Jaime H Martinez*

---

Jaime H Martinez, MBA, Budget & Business Analyst

**HARRIS COUNTY DEPARTMENT OF EDUCATION**  
**Monthly Investment Report as of June 30, 2021**  
 (unaudited)

**\$55,728,928 HCDE - Portfolio by Investment Type**

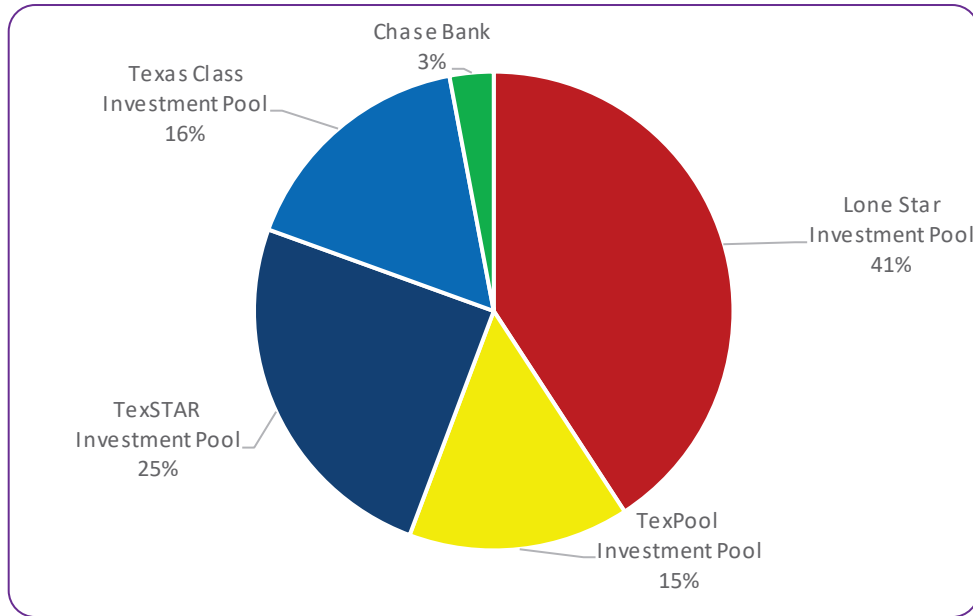

INVESTMENT ( BOOK VALUE )	GENERAL FUND	CONSTRUCTION FUND MAINTENANCE NOTES	WORKERS COMP.	RETIREMENT LEAVE FUND	AGENCY FUNDS	TOTAL INVESTED	PERCENT OF TOTAL
Lone Star Investment Pool	7,417,905	15,322,904	-	-	-	22,740,809	40.8%
TexPool Investment Pool	7,387,435	-	-	918,236	-	8,305,671	14.9%
TexSTAR Investment Pool	13,832,797	-	-	-	-	13,832,797	24.8%
Texas Class Investment Pool	8,192,091	-	1,004,258	-	-	9,196,349	16.5%
Chase Bank	1,612,540	-	-	-	40,763	1,653,302	3.0%
<b>Totals</b>	<b>\$ 38,442,768</b>	<b>\$ 15,322,904</b>	<b>\$ 1,004,258</b>	<b>\$ 918,236</b>	<b>\$ 40,763</b>	<b>\$ 55,728,928</b>	<b>100.00%</b>

[Shown at Book Value]

**HARRIS COUNTY DEPARTMENT OF EDUCATION**  
**Monthly Investment Report as of June 30, 2021**  
 (unaudited)

**Summary Schedule of Weighted Average Maturity (A) –  
 Investment Type General Fund**

( #1 ) INVESTMENT TYPE	( #2 ) BOOK VALUE	( #3 ) DAYS TO MATURITY	( #4 ) BOOK VALUE * DAYS (#2) * (#3)	WEIGHTED AVERAGE MATURITY (B)
First Public/Lone Star Inv Pool	\$ 22,740,809	1	\$ 22,740,809	19.18
TexPool Inv Pool	8,305,671	1	8,305,671	4.47
TexSTAR Inv Pool	13,832,797	1	13,832,797	9.93
Texas Class	9,196,349	1	9,196,349	3.47
Banks: Overnight & Cash	1,653,302	1	1,653,302	-
<b>Totals</b>	<b>\$ 55,728,928</b>		<b>\$ 55,728,928</b>	<b>9.26</b>

- (A) For HCDE all deposits are due on demand. In this case the WAM = the total (#4) of \$55,728,928 Divided by (#2) Book Value = 1 Days to Maturity
- (B) The WAM of 9.26 is for the entire investment pool.

This measure is useful in determining the degree of market or interest rate risk. The longer the WAM, the more exposure to market risk and the more potential for capital gains or losses.

Although TexPool, TexSTAR, Texas Class and Lone Star have a weighted average maturity greater than one, the funds are available to the Department within one day. HCDE holds investments to maturity, which minimizes this market exposure.

**HARRIS COUNTY DEPARTMENT OF EDUCATION**  
**Monthly Investment Report as of June 30, 2021**  
**(unaudited)**

**General Fund – Portfolio by Maturity Dates**

Investments are purchased to meet the cash flow needs of the Department. The bar graph on this page depicts the maturity schedule of the Department’s investments by monthly intervals. Although TexPool, TexSTAR, Texas Class and Lone Star have a weighted average maturity greater than one, the funds are available to the Department within one day. As of the end of this quarter, investments will mature:

- 100 % within one month

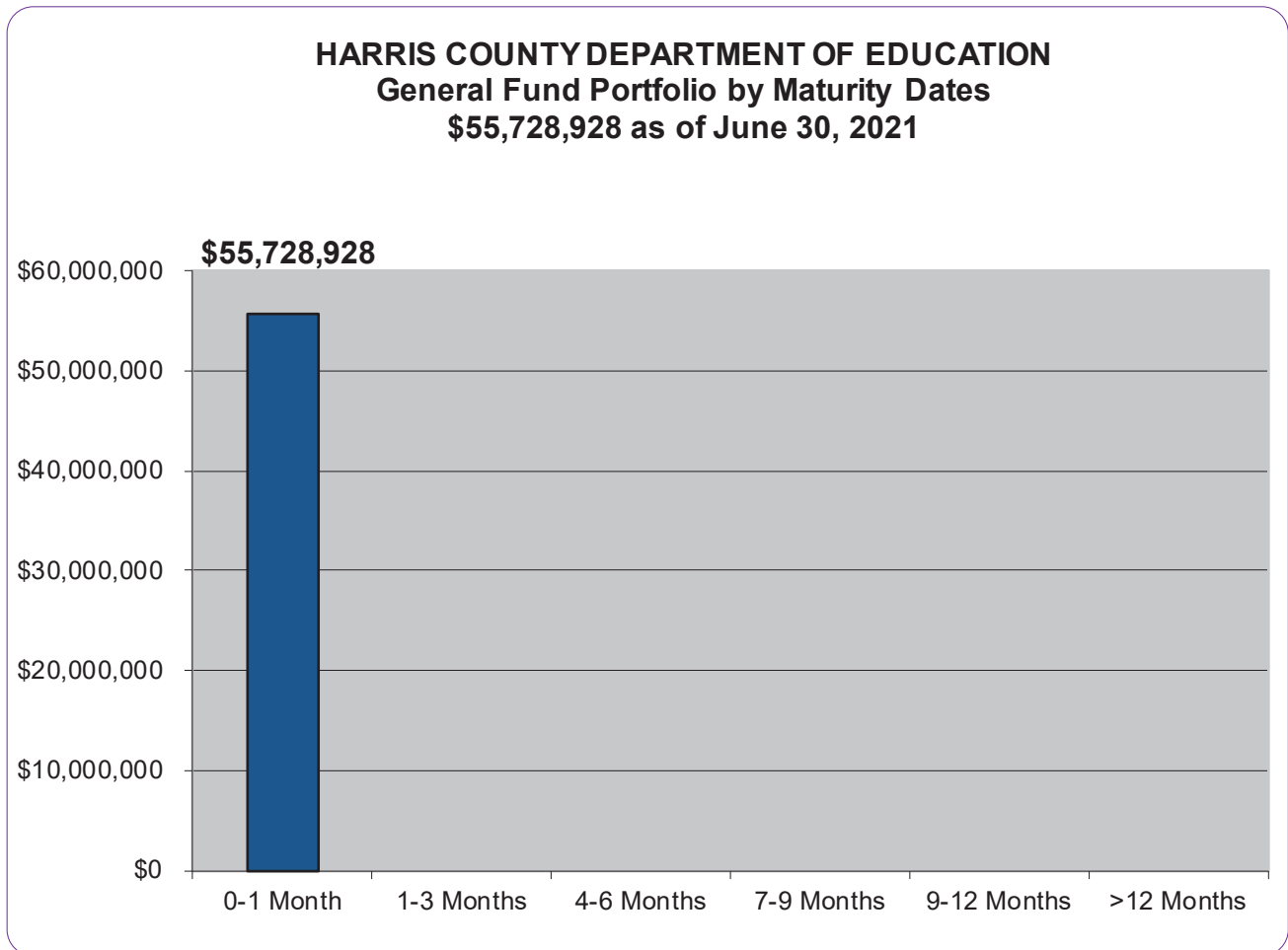

**HARRIS COUNTY DEPARTMENT OF EDUCATION**  
**Monthly Investment Report as of June 30, 2021**  
(unaudited)

**Investment Earnings Reports**

**(A) Interest Earned by Fund by Source - For This Month**

INVESTMENT	GENERAL FUND	WORKERS COMP.	RETIREMENT LEAVE FUND	TOTAL INTEREST EARNED
Cash Accounts	\$ -	\$ -	\$ -	\$ -
Lone Star Investment Pool	96	-	-	96
TexPool Investment Pool	79	-	10	89
TexSTAR Investment Pool	123	-	-	123
Texas Class Investment Pool	245	30	-	274
<b>Totals</b>	<b>\$ 544</b>	<b>\$ 30</b>	<b>\$ 10</b>	<b>\$ 583</b>

**(B) Interest Earned by Fund - Comparison of Quarters for FY 2020-21**

FUND	FIRST QUARTER SEPTEMBER TO NOVEMBER	SECOND QUARTER DECEMBER TO FEBRUARY	THIRD QUARTER MARCH TO MAY	FOURTH QUARTER JUNE TO AUGUST	INTEREST EARNED YEAR TO DATE
General Fund	\$ 8,191	\$ 4,810	\$ 2,038	\$ 478	\$ 15,517
Workers Compensation	326	180	114	30	650
Construction Fund	-	1,886	325	65	2,276
Retirement Leave Fund	308	163	33	10	514
<b>Totals</b>	<b>\$ 8,824</b>	<b>\$ 7,039</b>	<b>\$ 2,510</b>	<b>\$ 583</b>	<b>\$ 18,956</b>

**(C) Budget vs Actual Summary of Interest Earned Year-to-Date**

	Budgeted	Actual	Bal to Rec	% Rec'd
<b>FUND</b>	<b>BUDGETED</b>	<b>ACTUAL</b>	<b>BALANCE TO REC</b>	<b>% REC'D</b>
General Fund	\$ 170,000	\$ 15,517	\$ 154,483	9%
Workers Compensation	-	650	(650)	-
Construction Fund	-	2,276	(2,276)	-
Retirement Leave Fund	-	514	(514)	-
<b>Totals:</b>	<b>\$ 170,000</b>	<b>\$ 18,956</b>	<b>\$ 151,044</b>	<b>11%</b>

**HARRIS COUNTY DEPARTMENT OF EDUCATION**  
**Monthly Investment Report as of June 30, 2021**  
 (unaudited)

**Summary Report**

Beginning Book Value	\$ 59,280,089
Beginning Market Value	\$ 59,280,089
Beginning Weighted Average to Maturity	1 Day
Ending Book Value	\$ 55,728,928
Ending Market Value	\$ 55,728,928
Earnings for Period	\$583
Change in Book Value	\$ (3,551,161)
Change in Market Value	\$ (3,551,161)
Ending Weighted Average to Maturity	1 Day
Period Average Yield	0.019%
Period Average Benchmark **	<b>0.020%</b>

\*\* Benchmark = **13 Week Treasury Bill at Maturity**



**HARRIS COUNTY DEPARTMENT OF EDUCATION**  
 General Fund Monthly Inventory Report  
 As of June 30, 2021  
 (unaudited)

PURCHASE DATE	INVESTMENT	ACCOUNT/ CUSIP #	MATURITY DATE	YIELD	INTEREST PAID	5/31/2021		6/30/2021	
						MARKET	BOOK (*)	MARKET	BOOK (*)
<b>Bank Funds</b>									
-	Checking Accounts	All Funds (Note)	-	0.00%	-	\$ 2,464,691.69	\$	2,464,691.69	\$ 1,653,302.11
<b>Investment Pools</b>									
-	Lone Star	Construction / Maintenance	N/A	0.01%	65.05	15,536,172.15		15,536,172.15	15,322,903.71
-	Lone Star	Gen Fund	N/A	0.01%	31.16	7,417,873.80		7,417,873.80	7,417,904.96
-	TexPool	Ret Lv Fund	N/A	0.01%	9.77	918,226.46		918,226.46	918,236.23
-	TexPool	General Fund	N/A	0.01%	79.38	7,387,355.45		7,387,355.45	7,387,434.83
-	TexStar	Gen Fund	N/A	0.01%	123.45	16,359,694.81		16,359,694.81	13,832,797.49
-	Texas Class	Gen Fund	N/A	0.04%	244.52	8,191,846.47		8,191,846.47	8,192,090.99
-	Texas Class	Workers Comp	N/A	0.04%	29.95	1,004,227.92		1,004,227.92	1,004,257.87
<b>Totals:</b>						<b>\$583.28</b>	<b>\$59,280,088.75</b>	<b>\$59,280,088.75</b>	<b>\$55,728,928.19</b>

(\*) Financial institution statement data which is reconciled to the general ledger.

**HARRIS COUNTY DEPARTMENT OF EDUCATION  
PUBLIC FACILITY CORPORATION**  
Monthly Investment Report as of June 30, 2021  
(unaudited)

**\$30,608,362 PFC - Portfolio by Investment Type**

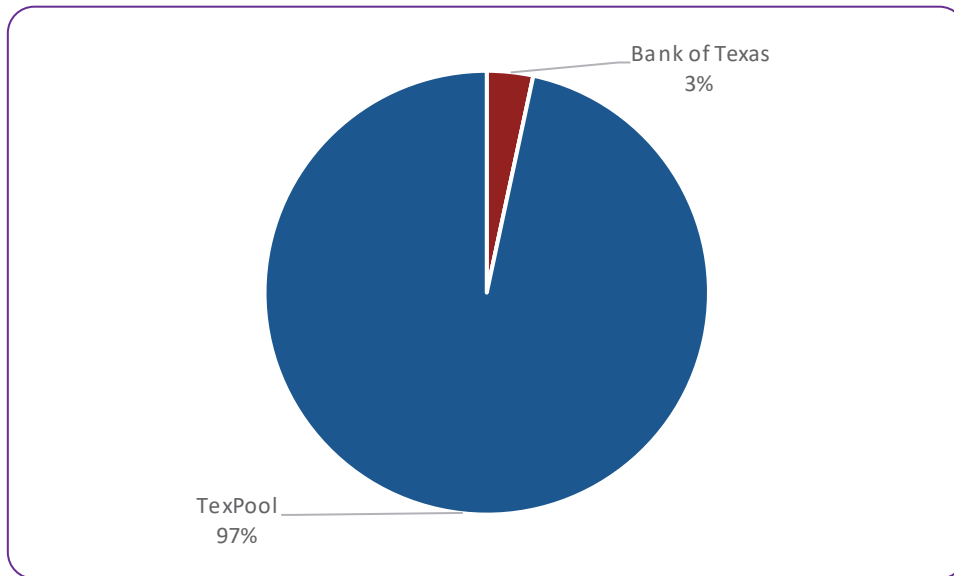

PFC INVESTMENT TYPE	AMOUNT INVESTED	% OF TOTAL
Bank of Texas Funds	1,029,751	3%
TexPool Investment Pools	29,578,611	97%
<b>Total</b>	<b>30,608,362</b>	<b>100%</b>



**HARRIS COUNTY DEPARTMENT OF EDUCATION  
PUBLIC FACILITY CORPORATION  
Monthly Investment Report as of June 30, 2021  
(unaudited)**

**PFC-Portfolio by Maturity Dates**

Investments are purchased to meet the cash flow needs of the PFC. The bar graph on this page depicts the maturity schedule of PFC investments by monthly intervals. As of the end of this quarter, investments will mature:

- 100 % within one month.

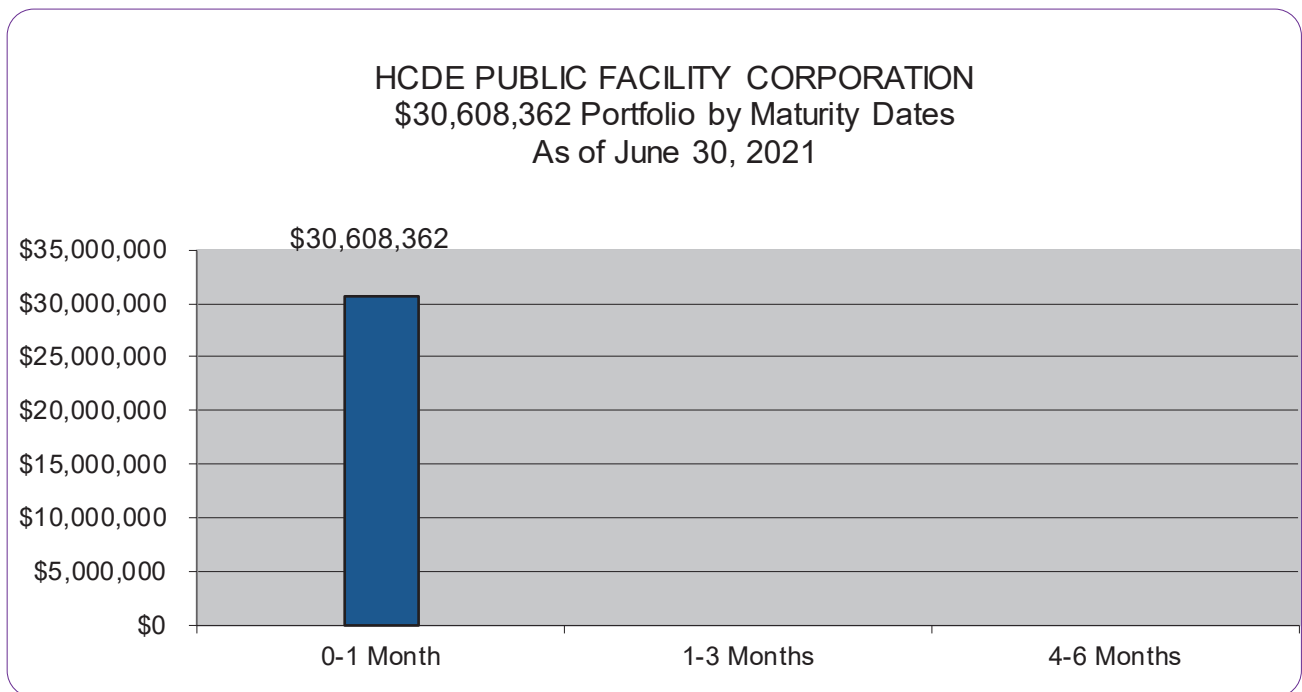



**HARRIS COUNTY DEPARTMENT OF EDUCATION**  
 Public Facility Corporation Monthly Inventory Report  
 As of June 30, 2021  
 (unaudited)

PURCHASE DATE	INVESTMENT	ACCOUNT/ CUSIP #	MATURITY DATE	YIELD	INTEREST PAID	5/31/2021		6/30/2021	
						MARKET	BOOK	MARKET	BOOK
<b>Bank Funds</b>									
-	Bank of Texas Accounts	All Funds	-	0.01%	7.24	\$ 1,029,744.14	\$ 1,029,744.14	\$ 1,029,751.38	\$ 1,029,751.38
<b>Investment Pools</b>									
-	TexPool	2020 Lease Revenue Bonds	N/A	0.01%	319.19	29,762,229.28	29,762,229.28	29,578,610.90	29,578,610.90
<b>Totals:</b>						<b>\$326.43</b>	<b>\$ 30,791,973.42</b>	<b>\$ 30,608,362.28</b>	<b>\$ 30,608,362.28</b>

**HARRIS COUNTY DEPARTMENT OF EDUCATION  
PUBLIC FACILITY CORPORATION**  
Monthly Investment Report as of June 30, 2021  
(unaudited)

**Bank Accounts**

The fund invests in high quality, short-term money market instruments, which are issued and payable in U.S. dollars.

The following is a list of all Bank of Texas Accounts and their balances:

2014 Payment Account	\$	3,138.84
2014 Redemption Account		244.18
2015 Payment Account		31,434.61
2015 Redemption Account		77.73
2016 Payment Account –		918,111.24
2016 Payment Account – Redemption		13.24
2020 Payment Account –		1,606.63
2020 Project Account –		<u>75,124.91</u>
Total Bank of Texas Accounts:		\$ 1,029,751.38

The following is a list of all TexPool Accounts and their balances:

2020 Lease Revenue Bonds		<u>\$ 29,578,610.90</u>
Total Bank Accounts:		<u>\$ 30,608,362.28</u>

**HARRIS COUNTY DEPARTMENT OF EDUCATION  
PUBLIC FACILITY CORPORATION**  
Monthly Investment Report as of June 30, 2021  
(unaudited)

**Investment Earnings Reports**

**(A) Interest Earned by Source - For This Month**

INVESTMENT TYPE	INTEREST EARNED	TOTAL
Bank of Texas Funds	\$ 7	\$ 7
TexPool Investment Pools	\$ 319	\$ 319
<b>Totals</b>	<b>\$ 326</b>	<b>\$ 326</b>

**(B) Interest Earned-Comparison of Quarters for FY 2020-21**

FUND	FIRST QUARTER SEPTEMBER TO NOVEMBER	SECOND QUARTER DECEMBER TO FEBRUARY	THIRD QUARTER MARCH TO MAY	FOURTH QUARTER JUNE TO AUGUST	INTEREST EARNED YEAR TO DATE
PFC Fund	17	4,387	1,119	326	5,850
<b>Totals</b>	<b>17</b>	<b>4,387</b>	<b>1,119</b>	<b>326</b>	<b>5,850</b>

**(C) Budget v Actual Summary of Interest Earned Year-to-Date**

FUND	BUDGETED	ACTUAL	BALANCE TO REC	% REC'D
Public Facilities Corporation (PFC)	-	5,850	(5,850)	0%
<b>Totals:</b>	<b>\$ -</b>	<b>\$ 5,850</b>	<b>\$ (5,850)</b>	<b>0%</b>

# HARRIS COUNTY DEPARTMENT OF EDUCATION

## Monthly Investment Report

### Glossary of Investment Terms

<b>Accretion</b>	The daily book value earned daily (on a straight-line basis) on securities purchased at a discount. At maturity, a discount security will be worth the face value. The types of securities involved are usually treasury bills, discount notes, commercial paper, and bankers' acceptances.
<b>Amortization</b>	The daily book value earned daily (on a straight-line basis) on securities purchased at a premium. To correctly account for premium amortization, it must be subtracted from the coupon interest either monthly or at maturity.
<b>Bank of Texas Funds</b>	Bank of Texas are unsecured money market accounts where the Public Facilities Corporation funds are kept unless otherwise invested.
<b>Benchmark for Investments</b>	HCDE uses the 13-week (90 day) Treasury Bill investment rate of the maturity date closest to the end of the month- <a href="http://www.treasurydirect.gov">www.treasurydirect.gov</a> .
<b>Book Value</b>	The face amount minus any unaccredited discount or plus any unamortized premium. See Accretion and Amortization.
<b>Cash</b>	Cash includes readily available cash, current bank accounts and certificates of deposit. Cash is the most liquid asset.
<b>Commercial Paper</b>	An unsecured promissory note issued by a corporation with a fixed maturity. The issuer (such as Coca Cola, General Electric, Kimberly Clark) promises to pay the buyer a fixed amount on some future date but pledges no assets, only his liquidity and established earning power, to guarantee that promise. These investment instruments usually yield 10-15 basis points above comparative agency investments. HCDE will not invest in commercial paper with less than A1 or P1 or an equivalent rating.
<b>Credit Risk</b>	The risk of issuer failure; mitigated by selecting high quality investment vehicles.
<b>CUSIP #</b>	The <b>C</b> ommittee on <b>U</b> niform <b>S</b> ecurities <b>I</b> dentification <b>P</b> rocedures Number: the identification number on all securities (often nine digits in length).
<b>Diversification</b>	To invest in a variety of different Board-authorized investment types (sector): treasuries, agencies, certificates of deposit, commercial paper, investment pools, and money market funds.

<b>Face Value</b>	Redemption value printed on the face of the certificate, same as par value.
<b>FHLB</b>	<b>F</b> ederal <b>H</b> ome <b>L</b> oan <b>B</b> ank System, established in 1932, includes 12 banks and their member institutions. Federal Home Loan Banks are instrumentalities of the United State government.
<b>FHLMC</b>	<b>F</b> ederal <b>H</b> ome <b>L</b> oan <b>M</b> ortgage <b>C</b> orporation < <b>Freddie Mac</b> > is a stockholder-owned corporation chartered by Congress in 1970 to keep money flowing to mortgage lenders in support of homeownership and rental housing.
<b>FICO</b>	<b>F</b> inancial <b>C</b> orporation was set up to fund the bailout of Savings and Loans in the 1980's. It was an offshoot of the <b>F</b> ederal <b>S</b> avings and <b>L</b> oan <b>I</b> nsurance <b>C</b> orporation (FSLIC).
<b>Fiduciary Responsibility</b>	The Board retains the ultimate responsibility as fiduciaries of the assets of the Department. Also see Standard of Care.
<b>FNMA</b>	<b>F</b> ederal <b>N</b> ational <b>M</b> ortgage <b>A</b> ssociation < <b>Fannie Mae</b> > is a federally Chartered and stockholder owned corporation. It is the largest investor in home mortgages in the United States. FNMA provides funds to the mortgage market by purchasing mortgages.
<b>Investment Pool</b>	An entity created under government code to invest public funds jointly on behalf of entities participating in the pool and whose investment objectives, in order of priority, are preservation and safety of principal; liquidity; and yield.
<b>Interest Rate Risk</b>	The uncertainty that the value of the instrument may fluctuate in value in response to changes in interest rates; mitigated by holding the instrument whenever possible to maturity.
<b>Investments</b>	Securities and other assets acquired primarily for the purpose of obtaining income or profit.
<b>Lone Star Investment Pool</b>	The Lone Star Investment Pool (LSIP) is a public funds investment pool administered by First Public, LLC.
<b>Liquidity</b>	Degree of availability of an asset; ease of converting the asset to cash.

<b>Liquidity Risk</b>	The risk that the investment may not be sold immediately-before it matures- at its market value.
<b>Market Value</b>	Value of an agency security if you were to sell that security on a given date. Market value changes daily, and normally increases as the maturity date of the security instrument approaches.
<b>Market Risk</b>	The risk that market prices will fall and threaten liquidity.
<b>Maturity Date</b>	The date the principal amount of a security becomes due and payable
<b>Par Value</b>	Redemption value printed on the face of the certificate. Par value = face value; and the par value of a security is different than its market value.
<b>Portfolio Risk</b>	The risk that remains after considering the risk-reducing effects of combining securities into a portfolio that efficiently balances its risks with its rate of return.
<b>Purchase Date</b>	The date of the initial purchase of the financial investment.
<b>Risks</b>	[Definitions can be found under individual listings.] Types of risk include: <ul style="list-style-type: none"> <li>• Credit risk</li> <li>• Interest rate risk</li> <li>• Liquidity risk</li> <li>• Market risk</li> <li>• Portfolio risk</li> <li>• Volatility risk</li> </ul>
<b>Safety of Principal</b>	The primary concern and responsibility of the Department's Board and investment officers is the preservation of assets. Cash is invested with the objective of the probable income to be derived, but, more importantly, the safety of the original capital.
<b>Sold Date</b>	The date the financial instrument is sold prior to the maturity date.
<b>Standard of Care</b>	In the administration of the duties of an investment officer, the designated investment officer(s) shall exercise the judgment and care, under prevailing circumstances that a person of prudence, discretion, and intelligence would exercise in the management of their own affairs.
<b>Sterling Bank Overnight</b>	Sterling Bank SDIT Government Portfolio Class C, this is an unsecured money market account in which equalization funds in

**Sweep Account** excess of \$350,000 remaining in Sterling Bank checking accounts at the end of the business day and matured securities in our safekeeping account are invested.

**TexPool** The Texas Local Government Investment Pool is a public fund investment pool overseen by the State Comptroller's office and currently managed by Lehman Brothers and Federated Investors.

**Treasury Zero** Treasury bills are short-term obligations issued with a term of one year or less. Treasury Zero bills are sold at a discount from face value and do not pay interest until maturity. Schedule 13 Continued

**U.S. Agency Securities** The federal government has established approximately 20 different agencies and instrumentalities to channel funds to sectors of the economy U.S. Agency securities are purchased directly by the department from investment brokerage firms registered to do business with the Department. These securities are issued in the Department's name, cleared through the Federal Reserve Bank system, and held in safekeeping by a third party.

**Volatility Risk** The risk that market prices will move significantly and increase market risk.

**Weighted Average to Maturity (WAM)** The average time it takes for securities in a portfolio to mature, weighted in proportion to the dollar amount that is invested in the portfolio. Weighted average maturity measures the sensitivity of fixed-income portfolios to interest rate changes. Portfolios with longer WAMs are more sensitive to changes in interest rates because the longer an investment is held, the greater the opportunity for interest rates to move up or down and affect the performance of the investment.

**Wells Fargo Money Market Funds** Wells Fargo Money Market Funds are unsecured money market accounts where the Public Facilities Corporation funds are kept unless otherwise invested.

**Yield-Current** Rate of return on investment as a % of market price including accrued interest.

**Yield to Maturity** The current income yield minus any premium above par or plus any discount from par in purchase price, with the adjustment spread over the period from the date of purchase to the date of maturity of the bond.



# Minutes

**HARRIS COUNTY DEPARTMENT OF EDUCATION  
6300 IRVINGTON BOULEVARD  
HOUSTON, TEXAS 77022**

The Harris County Board of School Trustees Budget Committee met in a Budget Committee Workshop Meeting on June 15, 2021, in room 502, 6300 Irvington Boulevard, Houston, Texas. The meeting was called to order at 12:31 p.m., it was declared that the meeting was duly called, and that notice of the meeting was posted in accordance with the Texas Open Meetings Act, Gov't. Code §551.041 and §551.051.

**Board Members Present:**

Danny Norris, Board President; Richard Cantu, First Vice-President; Andrea Duhon, Second Vice-President; Eric Dick

David Brown participated via Zoom videoconference

**Board Members Absent:**

Amy Hinojosa; and Erica Davis

**Administration:**

James Colbert, Jr., County School Superintendent; Jesus Amezcua, CPA, Assistant Superintendent for Business Services; Jonathan Parker, Assistant Superintendent for Academic Support Services; CJ Rodgers, Assistant Superintendent for Education and Enrichment; Danielle Bartz, Chief of Staff; Danielle Clark, Chief of Communications; Natasha Truitt, Executive Director Human Resources; Rich Vela, Senior Director Facilities

**Board Attorney:**

Sarah Langlois

**Visitors:**

Erin Kolecki, TASB HR Services, participated via Zoom

**Purpose:**

The Board Budget Committee met to discuss the Fiscal Year 2021-2022 budget, including tax rate calculations, recommended tax rate and property values and to hear a presentation by TASB HR Services on the HCDE compensation plan.

No action was taken.

**Adjourn:**

*The meeting adjourned at 2:14 p.m.*

---

Board President

---

Board Vice President

**Harris County Department of Education  
Minutes of Special Board Meeting  
June 15, 2021**

---

The Harris County Board of School Trustees met in a Special Meeting on June 15, 2021 in room 502, at 6300 Irvington Boulevard, Houston, Texas. Danny Norris, Board President, called the meeting to order at 11:43 a.m. and declared a quorum present, that the meeting was duly called, and that notice of the meeting was posted in accordance with the Texas Open Meetings Act, Gov't. Code §551.041 and §551.051.

**Board Members Present:** Danny Norris, Board President; Andrea Duhon, Second Vice President; and Eric Dick

David Brown participated via Zoom.

Richard Cantu, First Vice President arrived at 12:03 p.m.

**Board Members Absent:** Erica Davis; and Amy Hinojosa

**Board Attorney:** Sarah Langlois

**Administration:** James Colbert, Jr., County School Superintendent; Jesus Amezcua, CPA, Assistant Superintendent for Business Services; Jonathan Parker, Assistant Superintendent for Academic Support Services; CJ Rodgers, Assistant Superintendent for Education and Enrichment; Danielle Bartz, Chief of Staff; Danielle Clark, Chief Communications Officer; Karla Cantu, Board Secretary; Natasha Truitt, Executive Director Human Resources; and Rich Vela, Senior Director Facilities

**Visitors:** JP Grom, LAN

*The Board entered into Executive Session at 11:43 a.m.*

4. **Closed session – Tex. Govt. Code Section 551.071:** Consultation with Board Attorney regarding all matters as authorized by law

**A.Obtain legal advice** regarding termination of agreement with architect for Renovation of the Reagan (Irvington) Administration building project.

*The Board entered into Open Session at 12:17 p.m.*

1. **Open Forum – Gov’t Code 551.003(5) – Public Participation.** Pursuant to Policy BED (Local), a citizen who wishes to speak may do so by completing a participation request card available at the Board room at least 10 minutes prior to a regular Board meeting. At called board meetings, the Board shall hear persons who desire to make comments to the Board on agenda items.

*No one from the public requested to address the Board.*

2. **Public Hearing – Retention Incentive**

*A public hearing was held regarding the one-time retention incentive. No one from the public requested to address the Board.*

3. **Consider approval of resolution regarding one-time retention incentive**

*Motion made by Andrea Duhon, seconded by Eric Dick that after public hearing and discussion, the HCDE Board of Trustees approve a Board Resolution amending the 2020-2021 budget and compensation plan to approve a one-time retention incentive payment to (1) all full-time benefits-eligible employees of record at September 8, 2020 and who are returning for and complete the 2021-2022 fall semester in the amount of \$500 and (2) all part-time benefits-eligible employees of record at September 8, 2020 and who are returning for and complete the 2021-2022 fall semester in the amount of \$250, as set forth in the Board Resolution. Such payment is being made for the public purposes of ensuring continued retention, high job satisfaction and productivity; and maintaining sound fiscal management and stability in times of unprecedented additional job duties, and the funds for this payment shall come from the general fund. The payment will be distributed on or about August 20, 2021 as further set forth in the Resolution.*

*Motion passes with 5-0 voting to approve the Resolution.*

5. **Reconvene for possible action on items discussed in executive session.**

**A.Consider termination of agreement with architect for Renovation of the Reagan (Irvington) Administration building project** and delegate authority to the Superintendent or his designee to negotiate, finalize, and execute all necessary documents to effectuate such termination.

*Motion made by Eric Dick, seconded by Richard Cantu to terminate the agreement with the architect for the Renovation of the Reagan (Irvington) Administration building project and delegate authority to the Superintendent or his designee to negotiate, finalize, and execute all necessary documents to effectuate such termination.*

*Motion passes with 5-0 voting to terminate.*

**B. Consider selection of Cre8 Architects for the HCDE Capital Improvement Program Project of Renovation of the Reagan (Irvington) Administration building project – funded through Series 2020 Maintenance Tax Notes**, based on demonstrated competence and qualifications, pursuant to RFQ #20/043IA, and delegate authority to the Superintendent or his designee to negotiate, finalize, and execute a contract for the project for a fair and reasonable price.

*Motion made by Eric Dick, seconded by Richard Cantu to select Cre8 Architects for the HCDE Capital Improvement Program Project of Renovation of the Reagan (Irvington) Administration building project – funded through Series 2020 Maintenance Tax Notes, based on demonstrated competence and qualifications, pursuant to RFQ #20/043IA, and delegate authority to the Superintendent or his designee to negotiate, finalize, and execute a contract for the project for a fair and reasonable price.*

*Motion passes with 5-0 voting to select.*

**6. Adjournment**

*Motion made by Eric Dick, seconded by Andrea Duhon to adjourn the meeting.*

*Motion passes with 5-0 voting to approve.*

*The meeting adjourned at 12:23 p.m.*

---

Board President

---

Board Vice President

**HARRIS COUNTY DEPARTMENT OF EDUCATION  
6300 IRVINGTON BOULEVARD  
HOUSTON, TEXAS 77022**

The Harris County Board of School Trustees Government Relations Committee met in a Committee Meeting on June 16, 2021, in room 501, 6300 Irvington Boulevard, Houston, Texas. The meeting was called to order at 11:16 a.m. and declared that the meeting was duly called, and that notice of the meeting was posted in accordance with the Texas Open Meetings Act, Gov't. Code §551.041 and §551.051.

<b>Board Members Present:</b>	Danny Norris, Board President; Erica Davis; Eric Dick Andrea Duhon, Second Vice President arrived at 11:20 a.m.; Richard Cantu, First Vice President arrived at 11:50 a.m.
<b>Board Members Absent:</b>	David Brown; and Amy Hinojosa
<b>Administration:</b>	James Colbert, Jr., County School Superintendent; Danielle Bartz, Chief of Staff
<b>Board Attorney:</b>	Sarah Langlois
<b>Visitors:</b>	None
<b>Purpose:</b>	The Board Government Relations Committee met to discuss the continuation of local and state representation and special legislative update and local partnerships.  No action was taken.
<b>Adjourn:</b>	<i>Motion to adjourn was made by Danny Norris, seconded by Richard Cantu.</i>  <i>Motion passes with 5-0 voting to adjourn.</i>  <i>The meeting adjourned at 12:15 p.m.</i>

\_\_\_\_\_  
Board President

\_\_\_\_\_  
Board Vice President

**Harris County Department of Education  
Minutes of Regular Board Meeting  
June 16, 2021**

---

The Harris County Board of School Trustees met in regular session on June 16, 2021 in the Board Room, at 6300 Irvington Boulevard, Houston, Texas. Danny Norris, Board President, called the meeting to order at 1:02 p.m. and declared a quorum present, that the meeting was duly called, and that notice of the meeting was posted in accordance with the Texas Open Meetings Act, Gov't. Code §551.041 and §551.051.

**Board Members Present:** Danny Norris, Board President; Richard Cantu, First Vice President; Andrea Duhon, Second Vice President; David Brown; Eric Dick; and Erica Davis

**Board Members Absent:** Amy Hinojosa

**Board Attorney:** Sarah Langlois

**Administration:** James Colbert, Jr., County School Superintendent; Jesus Amezcua, CPA, Assistant Superintendent for Business Services; Jonathan Parker, Assistant Superintendent for Academic Support; and CJ Rodgers, Assistant Superintendent for Education and Enrichment; Julia Andrews, Center for Safe & Secure Schools; Danielle Bartz, Chief of Staff; Karla Cantu, Board Secretary; Joe Carreon, Director Facilities Construction; Lisa Caruthers, Director CASE for Kids; Danielle Clark, Chief Communications Officer; Jeff Drury, Director Choice Partners Cooperative; Dave Einsel, Director Communications and Creative Services; Victor Keys, Principal ABS West; Charles Ned, Senior Director Schools Division; Kendra Jackson, Director Purchasing; Venetia Peacock, Senior Director Head Start; John Prestigiacomio, Director Facilities; Donna Treviño-Jones, Principal ABS East; Natasha Truitt, Executive Director Human Resources; Rich Vela, Senior Director; Courtney Waters, Principal

**Visitors:** Bret Hightower, School Based Medical Systems; Saad Jamal, School Based Medical Systems; Jasmine Bateau, School Based Medical Systems; Lance Sharp, School Based Medical Systems; and Natalia Ruiz, private citizen

1. **Invocation** - Debra Sanchez-Treese, Communications
2. **Pledge of Allegiance to the US flag** – Melissa Wilder, Choice Partners Cooperative
3. **Pledge of Allegiance to the Texas flag** – Melissa Wilder, Choice Partners Cooperative
4. **Open Forum** - Gov't Code 551.003 (5) - Public Participation. Pursuant to Policy BED (Local), a citizen who wishes to speak may do so by completing a participation request card available at the Board room at least 10 minutes prior to a regular Board meeting.  
*Bret Hightower, Saad Jamal, Jasmine Bateau, and Lance Sharp addressed the Board regarding School-Based Medical Services.*  
*Natalia Ruiz addressed the board regarding her property located at 619 King Street, in which HCDE has shown interest in purchasing.*
5. **Reports and presentations:**
  - A. **Announcement of awards from the Government Finance Officers Association (GFOA) for the HCDE Budget for Fiscal Year 2020-2021** - Jesus Amezcua, Assistant Superintendent for Business Services
  - B. **Superintendent Monthly Report** - *James Colbert introduced the new principal of Highpoint East, Courtney Waters, and he announced the hiring of the new executive assistant to the Board of Trustees, Venetia Baldwin, who will begin working June 28, 2021. Mr. Colbert reported that the Board committee had multiple meetings regarding the hiring of a new executive assistant, for which HCDE had 98 applicants. The Board committee interviewed 6 applicants and awarded the position to Ms. Baldwin. Finally, Mr. Colbert reported on the Board Walk on May 25, 2021 during which he and several Board members visited the Adult Education site, Highpoint East, ABS East and ABS West campuses. Superintendent Colbert reflected on an incident the group witnessed at a campus during this visit and commended the staff on the de-escalation process utilized with a student in distress. Superintendent Colbert explained that the same student involved in the incident was able to participate in the HCDE Chess Tournament just a few days later.*
  - C. **Annual Division Update on Choice Partners Cooperative** - Jeff Drury, Director
  - D. **Annual Division Updates on Communications and Marketing & Client Engagement** - Stephanie De Los Santos and Dave Einsel, Directors  
*Andrea Duhon left the room at 2:04 p.m. and returned at 2:07 p.m.*
  - E. **Other reports from Board members** concerning attendance or participation in a board or HCDE-related conference, event, activity, or committee; accolades for an HCDE staff member or other deserving person.  
*No reports were given by Board members.*



F. **Reports of Board Committees - Committee Chairs**

*No reports were given by Board committee chairs.*

G. **Monthly Financial Reports through 05/31/2021-** Jesus Amezcua, Assistant Superintendent for Business Services

*Eric Dick left the room at 2:15 p.m. and returned at 2:17 p.m.*

**Items removed from the consensus agenda:**

*Richard Cantu requested items 6.F.2. and 6.F.3. be removed from the consensus agenda.*

*Motion made by Andrea Duhon, seconded by Richard Cantu to approve the remaining items in the consensus agenda with the exceptions of items 6.F.2. and 6.F.3.*

*Motion passes with 6-0 voting to approve remaining items in the consensus agenda with the exceptions of items 6.F.2. and 6.F.3.*

6. **ACTION ITEMS - CONSENSUS**

A. Consider approval of the following Business Services items:

1. Monthly Disbursement Report
2. Monthly Budget Amendment Report
3. Monthly Investment Report for May 2021

B. Consider approval of the following Board Meeting Minutes:

1. 05/19/2021 Public Relations Committee Meeting Minutes
2. 05/19/2021 Board Meeting Minutes

C. Consider acceptance of the following grant awards:

1. **Consider acceptance of the Notice of Award (NOA) from the Department of Health and Human Services (HHS) Administration for Children and Families (ACF), Office of Head Start (OHS) for the Head Start Division (06CH011535-02-02) in the amount of \$147,613 for the period of 01/01/2021 through 12/31/2021.**
2. **Consider acceptance of the Notice of Award (NOA) 06HE000969-01-01 from the Department of Health and Human Services (HHS) Administration for Children and Families (ACF) for one-time supplemental funds authorized under the American Rescue Plan Act 2021, P.L. 117-2 in the amount of \$1,517,162.00 for the budget period of 04/01/2021 through 3/31/2023.**

D. Consider ratification/approval of the following Interlocal Contracts:

1. **CASE for Kids (revenue interlocal agreement amendment) with Harris County for the period of 04/22/2021 through 09/30/2021 in the amount up to \$712,250 to amend insurance requirements for CASE for Kids "Harris County Connections" grant recipients to support summer youth programming and camps.**

E. Consider approval of the following items for the HCDE Choice Partners Cooperative:

1. **Consider approval of Contract Renewal option for job no. 18/047TJ for Chemical Products and Services with the following vendors:** Armstrong Repair Center, Inc. (#18/047TJ-01); Auto-Chlor Services, LLC (#18/047TJ-02); Buckeye Cleaning Center-Houston (#18/047TJ-03); Ecolab, Inc. (#18/047TJ-04); Sanitech (#18/047TJ-06), and SFSPac Food Safety & Sanitation (#18/047TJ-07) for the period of 08/01/2021 through 07/31/2022.
2. **Consider approval of Contract Renewal option for job no. 18/052TJ Direct Delivery of Snacks and Beverages with the following vendors:** Sterling BV, Inc. dba Buena Vista Food Products, Inc. (#18/052TJ-01); J&J Snack Foods Sales Corp. (#18/052TJ-02); The Masters Distribution System Co., Inc. (#18/052TJ-03); JSB Industries, Inc. dba Muffin Town (#18/052TJ-04); and MinMor Industries, LLC dba Notables (#18/052TJ-05) for the period of 08/01/2021 through 07/31/2022.
3. **Consider approval of Contract Renewal option for job no. 18/054TJ Restaurant Branded Food Delivery with the following vendors:** MAC Pizza Management, Inc dba Domino's Pizza (#18/054TJ-01); Domino's, Inc. dba Domino's Pizza LLC (#18/054TJ-02), and Houston Pizza Ventures, LP dba Papa John's Pizza (#18/054TJ-04) for the period of 08/01/2021 through 07/31/2022.
4. **Consider approval of Contract Renewal option for job no. 19/038KC for STEM & CTE Materials & Related Items with the following vendors:** Accelerate Learning, Inc. (#19/038KC-01); MatlScience, Inc. (#19/038KC-03); TCC Learning, LLC (#19/038KC-05); Teaching Systems, Inc. (#19/038KC-06); Texas Pride Marketing (#19/038KC-07), and The Burmax Company, Inc. (#19/038KC-08) for the period 07/17/2021 through 07/16/2022.
5. **Consider approval of Contract Renewal option for job no. 19/035KD for Medical & Veterinary Supplies, Safety Equipment & Services with the following vendors:** Henry Schein, Inc. (#19/035KD-01); NAO Global Health, LLC (#19/035KD-04), and School Health Corporation (#19/035KD-06) for the period 07/17/2021 through 07/16/2022.
6. **Consider approval of Contract Renewal option for job no. 19/039TJ Food Equipment, Parts, Repair, Installation, Maintenance, Small Wares, and Related Items and Service with the following vendors:** 1st Choice Restaurant Equipment & Supply, LLC (#19/039TJ-01); Ace Mart Restaurant Supply Company, Inc. (#19/039TJ-02); American Vending Sales dba AVS Companies (#19/039TJ-03); TAI HING CORPORATION dba Budget Restaurant Supply (#19/039TJ-04); Greenwich Inc dba Commercial Kitchen Parts and Service (#19/039TJ-05); Coolers Incorporated (#19/039TJ-06); Parts Town, LLC dba Heritage Food Service Group, Inc. (#19/039TJ-07); ITW Food Equipment Group, LLC dba Hobart Service (#19/039TJ-08); Innoseal Systems Inc (#19/039TJ-09); Strategic Equipment, LLC dba ISI Commercial Refrigeration, LLC (#19/039TJ-10); Tari, Inc. dba Jeans Restaurant Supply (#19/039TJ-11); Terry Woodard Enterprises, LLC dba Kommercial Kitchens (#19/039TJ-13); Pasco Brokerage Inc. (#19/039TJ-15); Refrigeration Technologies, LLC (19/039TJ-16); Jennifer Chapman dba School Food Service Innovations, LLC (19/039TJ-17); Crazy Cousins, Inc. dba Shepherd Food Equipment,

Crazy Stainless and SFE Service (19/039TJ-18); and The Edu-Source Corporation (19/039TJ-19) for the period 08/01/2021 through 07/31/2022.

7. **Consider approval of Contract Renewal option for job no. 20/032KN for Instructional Resources, Textbooks & Related Items with the following vendors:** ABDO Publishing Company dba ABDO-Spotlight-Magic Wagon (#20/032KN-01); Barnes & Noble Booksellers, Inc. (#20/032KN-03); Complete Book and Media Supply, LLC (#20/032KN-08); Express Booksellers, LLC dba Express Booksellers (#20/032KN-09); Hipeware Labs, Inc. (#20/032KN-11); Houston A+ Challenge (#20/032KN-12); MT Library Services, Inc. dba Junior Library Guild (#20/032KN-13); KAMICO Instructional Media, Inc. (#20/032KN-14); Peoples Education, Inc. dba Mastery Education (#20/032KN-17); Newsela (#20/032KN-15); Hertzberg-New Method, Inc. dba Perma-Bound Books (#20/032KN-18); Rethink Autism (#20/032KN-20); Leticia Smith dba Risas y Sonrisas, LLC (#20/032KN-21); Scholastic, Inc. (#20/032KN-22); Waterford Institute dba Waterford Research Institute (#20/032KN-25), and X-CAL Corp (#20/032KN-26) for the period 07/15/2021 through 07/14/2022.
8. **Consider approval of Contract Renewal option for job no. 20/040TP Frozen and Chilled Beverages with the following vendors:** Barfresh Corporation, Inc. (#20/040TP-01), Smart Beverage, Inc. dba Thirsty Coconut (#20/040TP-02), and Trident Beverage, Inc. (#20/040TP-03) for the period of 08/01/2021 through 07/31/2022.
9. **Consider approval of the Contract Award for job no. 21/031KN for Technology Products and Services with the following vendors:** Your School Resource Group, Inc. dba 3 Oaks Resource Group International (#21/031KN-01); AC/DC Synergy Group, Inc. (#21/031KN-02); ACCO Brands Corporation dba ACCO Brands USA, LLC (#21/031KN-03); Advantage Imaging Supply, Inc. (#21/031KN-04); Agular Systems, Incorporated (#21/031KN-05); Apollo Companies, Inc. dba Apollo Office Systems, LLC (#21/031KN-06); AssetGenie Inc. dba AGiRepair & AGParts Education (#21/031KN-07); Avaya, Inc. (#21/031KN-08); Best Buy Stores, LP (#21/031KN-09); Binyod, LLC (#21/031KN-10); Blackboard, Inc. (21/031KN-11); Capsultek, LLC (#21/031KN-12); CDW LLC dba CDW Government LLC, CDW Government (#21/031KN-13); Challenge Office Products, Inc. (#21/031KN-14); Critical Infrastructure Solutions (CIS), LLC (#21/031KN-15); CX2, Inc. (#21/031KN-16); Digital Air Control, Inc. dba DAC, Inc. (#21/031KN-17); Education Logistics, Inc. (#21/031KN-18); E-Logic, Inc. (#21/031KN-19); Double M Laser Products, Inc. dba Enhanced Laser Products (#21/031KN-20); E-Rate Elite Services, Inc. (#21/031KN-21); Evolve Holdings, Inc. (#21/031KN-22); Robert Ferrilli, LLC dba Ferrilli (#21/031KN-23); FileWave USA, Inc. (#21/031KN-24); Food Handler Solutions, LLC (#21/031KN-25); Genesis Telecom Inc. dba Business Communication Solutions (#21/031KN-26); GovConnection Inc. dba Connection - Public Sector Solutions (#21/031KN-27); GTS Technology Solutions, Inc. (#21/031KN-28); HiEd, Inc. (#21/031KN-29); Staples, Inc. dba HiTouch Business Services, LLC (#21/031KN-30); 5205 Limited Partnership dba Houston Communications, Inc. (#21/031KN-31); Inflow Communications, LLC (#21/031KN-32); IPEVO, INC (#21/031KN-33); iTech Enterprises LLC dba iTech Solutions (#21/031KN-34); Lantana Communications Corp

(#21/031KN-35); LED OEM Partners, LLC dba LED Partners (#21/031KN-36); Liberty Data Products, Inc. dba Liberty Office Products (#21/031KN-37); LyncVerse Technologies (#21/031KN-38); MGT of America, LLC dba Mgt of America Consulting, LLC (#21/031KN-39); Micro Integration & Programming Solutions, Inc. (#21/031KN-40); Netsync Network Solutions (#21/031KN-41); Northwest Communications, Inc. dba NW Radio (#21/031KN-42); NWN Corporation (#21/031KN-43); Panorama Education, Inc. (#21/031KN-44); PCPC Direct, Ltd (#21/031KN-45); Performance Scoring, LLC (#21/031KN-46); Power Products Unlimited, LLC (#21/031KN-47); R.L.S. Interests, Inc. dba Prime Systems (#21/031KN-48); Protiviti, Inc. (#21/031KN-49); PS Lightwave, Inc. dba Pure Speed Lightwave (#21/031KN-50); Quasar Data Center, Ltd (#21/031KN-51); R3 Collaboratives, Inc. (#21/031KN-52); Revolution Data Systems, LLC (#21/031KN-53); Scribbles Software, LLC (#21/031KN-54); Set Solutions, Inc. (#21/031KN-55); Sirius Education Solutions, LLC dba Sirius Education Solutions (#21/031KN-56); Digi SmartSense, LLC dba SmartSense by Digi (#21/031KN-57); Solarcraft, Inc. (#21/031KN-58); Tec Solutions, Inc. (#21/031KN-59); Technical Laboratory Systems, Inc. (#21/031KN-60); Tekvisions, Inc. (#21/031KN-61); Telephonics Unlimited, Inc. (#21/031KN-62); The Library Corporation (#21/031KN-63); Troxell Communications, Inc. (#21/031KN-64); True North Consulting Group, LLC (#21/031KN-65); Unique Digital Technology, Inc. dba Unique Digital, Inc. (#21/031KN-66); United Training Commercial, LLC dba United Training (#21/031KN-67); Veritrust Corporation (#21/031KN-68); Webrevelation, Inc. (#21/031KN-69), and Dahill Office Technology Corporation dba Xerox Business Solutions Southwest (#21/031KN-70) for the period 06/16/2021 through 06/15/2022.

10. **Consider approval of the Contract Award for job no. 21/033SG for Athletic and Physical Supplies and Related Items with the following vendors:** Educator's Depot, Inc. (#21/033SG-01); Marty Gilman dba Gilman Gear (#21/033SG-02); Nasco Education, LLC dba Nasco (#21/033SG-03); Pyramid Paper Company dba Pyramid School Products (#21/033SG-04); S&S Worldwide, Inc. (#21/033SG-05), and Matherne, Inc. dba Texas Swim Shop (#21/033SG-06) for the period 06/16/2021 through 06/15/2022.
11. **Consider approval of the Contract Award for job no. 21/034SG for Boxes, Packaging Supplies, Freight Services, and Related Items with the following vendor:** Veritiv Operating Company (#21/034SG-01) for the period 06/16/2021 through 06/15/2022.
12. **Consider approval of the Contract Award for job no. 21/040SG for Automotive Equipment, Tires and Related Items with the following vendors:** Classic Chevrolet Sugar Land, LLC dba Classic Chevrolet Sugar Land (#21/040SG-01); The Goodyear Tire & Rubber Company dba Goodyear Commercial Tire & Service Centers (#21/040SG-02); Goolsbee Tire Service, Inc. (#21/040SG-03); Jasper Engine Exchange, Inc. (#21/040SG-04); Liftnow Automotive Equipment Corp. (#21/040SG-05); Magneto & Diesel Injector Service, Inc. dba M&D Distributors (#21/040SG-06), and James M. Orr dba Texas Pride Marketing (#21/040SG-07) for the period 06/16/2021 through 06/15/2022.

13. **Consider approval of the Contract Award for job no. 21/041LS for Ice Cream Products with the following vendors:** BlueBonnet DSD Irving Inc. dba BlueBonnet Ice Cream (#21/041LS-01); JA-EN Enterprises dba JP Ice Cream Distributors (#21/041LS-02); La Costenita Distribuidor, Inc. (#21/041LS-03); The Masters Distribution System Company, Inc. (#21/041LS-04); Paeteria El Pibe (#21/041LS-05); Yumi Ice Cream Co., Inc. (#21/041LS-06) for the period of one (1) year starting 08/01/2021 through 07/31/2022.
  14. **Consider approval of the Contract Award for job no. 21/042MJ for Moving, Storage and Related Items with the following vendors:** APMS of Houston, LLC dba All Points of Texas (#21/042MJ-01); A-Rocket Moving & Storage, Inc. (#21/042MJ-02); Pioneer Contract Services, Inc. (#21/042MJ-03), and Roadrunner, Ltd dba Roadrunner Moving & Storage (#21/042MJ-04) for the period 06/16/2021 through 06/15/2022.
  15. **Consider approval of the Contract Award for job no. 21/046LS for Site Based Pizza Program with the following vendor:** Bull's Eye Brands, Inc. dba Smart Mouth Foods (#21/046LS-01) for the period 08/01/2021 through 07/31/2022.
  16. **HCDE Interlocal Agreements with:** Tekoa Academy & Accelerated Studies STEM School, Port Arthur, Texas; Bowie ISD, Bowie Texas; Hamlin Collegiate ISD, Hamlin, Texas; Harris County Emergency Services District No. 11, Houston, Texas; Archuleta District 50 Jt, Pagosa Springs, CO; Casa Grande Elementary School District #4, Casa Grande, AZ, and Pasadena Economic Development Corporation, Pasadena, Texas.
- F. Consider approval of the following items for Internal Purchasing:
1. **Consider approval to increase the allowable maximum contract amount under CH Local FY 2021** for CDW-G, (job no. 18/056KD-13) (original amount \$700,000), requesting new total amount of \$1,100,000 (increase of \$400,000).
  4. **Consider approval of Contract Award for job no. 21/005IA-3 for CASE for Kids Content Area Services and Trainers with the following vendors:** edOpp Solutions, LLC; kid-grits, LLC; and Lakeshore Learning Materials (Lakeshore Equipment Company) for the period of 07/01/2021 through 06/30/2026.
  5. **Consider approval of Assignment of Contract for job no. 19/031IA-3 CASE for Kids Consultants and Trainers & 21/004IA-2 for CASE for Kids Youth Services for Afterschool and Summer** from Project GRAD Houston to Tejano Center for Community Concerns.
  6. **Consider approval of a Contract Renewal option for job no. 20/034IA Contracted Services for Wellness Program for Harris County Department of Education with:** Houston Methodist Hospital for the period of 07/01/2021 through 06/30/2022.
  7. **Consider approval of a Contract Renewal option for job no. 20/021IA for CASE for Kids After School and Summer Direct Service Providers with the following vendors:** AC Language School (Chavez & Associates), Baked With Confidence, Boykins Youth Foundations, Collaborate With Christina, Hypothesis Haven Science Club (Hypothesis Haven LLC), KCE Champions LLC, Connecting the Dots, Ondi Love Center Ministries, Sterling Empowerment, Texas Tutors, Training

and Leadership Consulting, and Writers in the Schools for the period of 07/01/2021 through 06/30/2022.

8. **Consider approval of a Contract Renewal option for job no. 20/027IA School Safety and Security Software for the Center for Safe and Secure Schools with the following vendor:** CrisisGo, Inc. for the period of 07/01/2021 through 06/30/2022.
- G. Consider approval of the following Revenue Agreements:
1. **Consider approval of Interlocal (revenue) contracts for FY 2022 in the aggregate amount of \$669,104 with Academic and Behavior School East** with the following districts: Clear Creek ISD for sixteen (16) in-county annual contracts in the amount of \$329,680 (\$20,605 each); Deer Park ISD for six (6) in-county annual contracts in the amount of \$123,630 (\$20,605 each); Pearland ISD for seven (7) in-county annual contracts in the amount of \$144,235 (\$20,605 each); Dickinson ISD for three (3) out-of-county annual contracts in the amount of \$71,559 (\$23,853 each) for the contract period of 08/23/2021 through 06/03/2022.
  2. **Consider approval of Interlocal (revenue) contracts for FY 2022 in the aggregate amount of \$679,965 with Academic and Behavior School West with the following district(s):** Alief ISD for thirty (30) in-county annual contracts in the amount of \$618,150 (\$20,605 each); and Katy ISD for three (3) in-county annual contracts in the amount of \$61,815 (\$20,605 each) for the contract period of 08/23/2021 through 06/03/2022.
  3. **Consider approval of Interlocal (revenue) contracts for FY 2022 for Therapy Services in the aggregate amount of \$181,155.00 with School-Based Therapy Services and following districts:** Greater Gulf Coast Cooperative (21 students served in FY20) in the amount of \$119,700.00; Pearland ISD (45 students served in FY20) in the amount of \$61,455.00.
  4. **Interlocal (revenue) contracts for FY 2022 for School-Based Therapy Services in the aggregate amount of \$409,820.50 with School-Based Therapy Services** and Spring Branch ISD (203 students served in FY20) in the amount of \$409,820.50.
6. F. 2. **Consider approval of Contract Award for job no. 21/038YR Workforce Certification Training for Harris County Department of Education for the Adult Education Division with the following proposer(s):** Resources Inspiring Success and Empowering for the period of 06/16/2021 through 06/15/2026 subject to annual appropriations of funding.

*Motion made Andrea Duhon, seconded by Richard Cantu to approve a Contract Award for job no. 21/038YR Workforce Certification Training for Harris County Department of Education for the Adult Education Division with the following proposer(s): Resources Inspiring Success and Empowering for the period of 06/16/2021 through 06/15/2026 subject to annual appropriations of funding.*

*Motion passes with 6-0 voting to approve.*

6. F. 3. **Consider approval of Contract award for job no. 21/029IA Early Head Start Child Care Partnership with the following vendors:** Association for the Advancement of Mexican Americans, Community Partners Early Childhood Development Center, and Successful Starters Learning Academy II for the period of 07/01/2021 through 06/30/2022.

*Motion made by Andrea Duhon, seconded by Erica Davis to approve a Contract award for job no. 21/029IA Early Head Start Child Care Partnership with the following vendors: Association for the Advancement of Mexican Americans, Community Partners Early Childhood Development Center, and Successful Starters Learning Academy II for the period of 07/01/2021 through 06/30/2022.*

*Motion passes with 6-0 voting to approve.*

7. **ACTION ITEMS - NON-CONSENSUS**

- A. **Consider ratification of lease agreement with Journey of Faith Church for the period 06/07/2021 to 08/31/2023** to provide for access for the Humble Head Start Center expansion.

*Motion made by Richard Cantu, seconded by Eric Dick to ratify a lease agreement with Journey of Faith Church for the period 06/07/2021 to 08/31/2023 to provide for access for the Humble Head Start Center expansion.*

*Motion passes with 6-0 voting to ratify.*

- B. **Consider approval of HCDE Early Head Start Child Care Partnerships (EHS-CCP) contracts with the following vendors:** Deskot LLC, DBA Kool Kids Daycare (RFP 20/039YR) in the amount of \$256,000, Fellowship of Purpose Early Childhood Learning Center (RFP 20/039YR) in the amount of \$107,000, John G Jones Learning Center (RFP 20/039YR) in the amount of \$62,000, and Let's Learn Innovative Learning Center (RFP 20/039YR) in the amount of \$69,000. Each contract will be valid 09/01/2021 through 08/31/2022 (Fully funded by the Head Start/Early Head Start grants).

*Motion made by David Brown, seconded by Richard Cantu to approve HCDE Early Head Start Child Care Partnerships (EHS-CCP) contracts with the following vendors: Deskot LLC, DBA Kool Kids Daycare (RFP 20/039YR) in the amount of \$256,000, Fellowship of Purpose Early Childhood Learning Center (RFP 20/039YR) in the amount of \$107,000, John G Jones Learning Center (RFP 20/039YR) in the amount of \$62,000, and Let's Learn Innovative Learning Center (RFP 20/039YR) in the amount of \$69,000. Each contract will be valid 09/01/2021 through 08/31/2022 (Fully funded by the Head Start/Early Head Start grants).*

*Motion passes with 6-0 voting to approve.*

- C. **Consider approval of Job Order Contract for the upgrade of the security camera system at HCDE's Westview location with Quality Security Systems (Job No. 20/018MJ-09)** in the total amount of \$79,018.80.

*Motion made by Richard Cantu, seconded by Erica Davis to approve a Job Order Contract for the upgrade of the security camera system at HCDE's Westview location*

with Quality Security Systems (Job No. 20/018MJ-09) in the total amount of \$79,018.80.

*Motion passes with 6-0 voting to approve.*

- D. **Consider award of CSP# 21/047YR for new Academic and Behavior School East campus to Construction, Ltd. in the amount of \$12,348,500**, including the base bid, Alternates 1A, 2A, 6, 7B, 8, 9, technology equipment indicated on the plans, short-throw projectors in the classrooms, the ceiling mounted projector in Dining B130 and the 3 flat panel TVs, and delegate authority to HCDE Superintendent or his designee to negotiate, finalize, and execute a construction contract with Construction, Ltd.

*Motion made by Richard Cantu, seconded by Andrea Duhon to award CSP# 21/047YR for new Academic and Behavior School East campus to Construction, Ltd. in the amount of \$12,348,500, including the base bid, Alternates 1A, 2A, 6, 7B, 8, 9, technology equipment indicated on the plans, short-throw projectors in the classrooms, the ceiling mounted projector in Dining B130 and the 3 flat panel TVs, and delegate authority to HCDE Superintendent or his designee to negotiate, finalize, and execute a construction contract with Construction, Ltd.*

*Motion passes with 6-0 voting to approve.*

- E. **Consider approval of the Adult Education Professional Development Stipend for part-time and full-time staff effective 07/01/2021.**

*Motion made by Richard Cantu, seconded by Andrea Duhon to approve the Adult Education Professional Development Stipend for part-time and full-time staff effective 07/01/2021.*

*Motion passes with 6-0 voting to approve.*

*The Board entered into Executive Session at 2:41 p.m.*

8. **EXECUTIVE SESSION** Under the Texas Government Code pursuant to any and all purposes permitted by Sections 551.001-551.084, including, but not limited to: 551.071; 551.072; 551.074
- A. **Deliberate the appointment, employment, evaluation, reassignment, duties, discipline and/or dismissal of HCDE employees.**
- B. **Deliberate the purchase, exchange, sale and/or value of real property(ies) and obtain legal advice regarding same.**

*The Board entered into Open Session at 3:30 p.m.*

9. **RECONVENE** for possible action on items discussed in executive session
- A. **Consider and Approve Purchase/Acquisition of Real Property near Adult Education Center** for Future Campus and/or Other Department Facilities and Delegate Authority to Superintendent Related to the Purchase/Acquisition

*Motion made by Richard Cantu, seconded by David Brown to approve the purchases of approximately 0.193 acres of land and 1,350 square feet of improvements, more or less, located at 619 King Street and approximately 0.347 acres of land and 6,000*



*square feet of improvements, more or less, located at 6311 Irvington Boulevard for a future campus and/or other Department facilities for purchase prices not to exceed the amounts discussed in closed session and delegate authority to the Superintendent or his designee to contract for due diligence professional services and negotiate, execute, amend, and/or terminate any agreements and closing documents related to the purchases, as discussed in closed session.*

*Motion passes with 6-0 voting to approve.*

10. **Discussion and possible action regarding future agenda items**

*Eric Dick stated that he invited Bret Hightower with School Based Medical Services, to present to the HCDE Board and expressed that he would like to see them back for another presentation.*

*Andrea Duhon requested an update from the Superintendent at the July 21, 2021 board meeting regarding the school supplies initiative.*

11. **INFORMATION ITEMS**

A. **Human Resources Information Items**

B. **HR Employee Count**

C. **Revenue contracts less than \$50,000 (Cumulative total \$167,752.50)**

- Between Teaching Learning Center and Cypress-Fairbanks ISD, New STAAR Items and Campus Success Tools, \$1,000
- Between Teaching Learning Center and Darul Arqam North, Digital Learning Training, \$3,500
- Between School-Based Therapy Services and Avondale House, Therapy Service, \$10,622
- Between ABS West and Waller ISD, Annual Student contract, \$23,853
- Between Fortis Academy and Galena Park ISD, Annual Student Contract, \$18,750
- Between ABS East and Shepherd ISD, Annual Student Contract, \$47,706
- Between ABS East and Tackington ISD, Annual Student Contract, \$23,853
- Between ABS East and Dayton ISD, Annual Student Contract, \$1,522.50
- Between ABS East and Pearland ISD, Annual Student Contract, \$36,946

D. **Vendor GV Implementation was awarded under job # 21/025YR** (Professional Development Services for Harris County Department of Education Teaching and Learning Center Division) at the 05/19/2021 Board meeting. The vendor's name appeared on the agenda item as "GV Implementation" which was incorrect. The correct name is "GW Implementation Solutions".

E. **Submission of grant application in the amount of \$8,680 to the NWEA Educators for Equity Grant via Education Foundation of Harris County to support CASE for Kids' CASE Debates program**, which brings competitive debate opportunities to 300 high school students in the Harris County area.

- F. **Submission of grant application in the amount of \$5,000 to the Bess Spiva Timmons Foundation via Education Foundation of Harris County to support CASE for Kids' CASE Debates program**, which brings competitive debate opportunities to 300 high school students in the Harris County area.
12. **ADJOURN** - Next regular meeting is scheduled for Wednesday, July 21, 2021, Board Room, 6300 Irvington Blvd., Houston, Texas, 77022, at 1:00 p.m.
- Motion made by David Brown, seconded by Erica Davis to adjourn the meeting.*
- Motion passes with 6-0 voting to adjourn.*
- The meeting adjourned at 3:43 p.m.*

---

Board President

---

First Vice President

# Action Items

**Regular Board Meeting****8.C.1.**

<b>Meeting Date:</b>	July 21, 2021		
<b>Title:</b>	CASE for Kids Nita M. Lowey 21st CCLC Cycle 11, Year 1 (NOGA)		
<b>Submitted For:</b>	Lisa Caruthers, Case for Kids	<b>Submitted By:</b>	Kimberlee Flowers
<b>Recommended Action:</b>	Accept	<b>HCDE Goal(s):</b>	2. Deliver value responsibly
<b>Additional Resource Personnel:</b>	Dr. Lisa Caruthers, Dr. Jesus Amezcua, Bill Monroe, Kendra Jackson	<b>Facilities/Technology Approval Needed?:</b>	

**Information****Posted Agenda Item:**

**Acceptance of funds totaling \$1,700,000 from the Texas Education Agency** for CASE for Kids' Nita M. Lowey 21st Century Community Learning Center(s) Cycle 11, Year 1 grant for the period 07/01/2021 through 07/31/2022; CASE for Kids anticipates serving 1,046 students and hiring 13 full-time positions and up to 50 quarter-time positions with these grant funds.

**Subject:**

Acceptance of the TEA Nita M. Lowey 21st Century Community Learning Center(s) Cycle 11, Year 1 grant awarded to CASE for Kids and hiring of 12 Full-Time positions and up to 50 quarter time positions.

**Rationale:**

The Texas Education Agency has granted funds for year one of a five-year 21st Century Community Learning Centers grant. These funds must be used to implement the five core components of the grant: (1) improve academic performance; (2) improve behavioral outcomes; (3) increase college and career readiness; (4) foster youth leadership; and (5) promote parent involvement. The following 10 centers from 5 districts and 2 charters were awarded as part of this TEA grant: George Sanchez in AAMA targeting 92 students, Alief Middle School and Killough Middle School in Alief ISD targeting 220 students, RipleyHouse in BakerRipley Promise School Charter targeting 92 students, Clear Creek Intermediate in Clear Creek ISD targeting 110 students, Cobb 6<sup>th</sup> Grade and Havard Elementary in Galena Park ISD targeting 220 students, Chavez High School in Houston ISD targeting 92 students and Humble Middle School and Sterling Middle School in Humble ISD targeting 220 students. To implement the 21st Century Community Learning Centers grant 13 Full-Time positions will be hired (1-A4, Project Director; 1-A2 Family Engagement Specialist; 2-A2 Regional Coordinators; 8-A1 Site Coordinators; and 1-S3 Administrative Assistant). To work at each awarded center, up to 50-52 quarter-time positions.

**Fiscal Impact****Attachments**

NOGA Email  
NOGA

**Form Review**

<b>Inbox</b>	<b>Reviewed By</b>	<b>Date</b>
CASE	Lisa Caruthers	06/28/2021 06:12 PM
Purchasing	Kendra Jackson	06/30/2021 01:09 PM
Assistant Superintendent - Business	Venetia Baldwin	07/06/2021 09:58 AM
Form Started By: Kimberlee Flowers		Started On: 06/28/2021 03:01 PM
Final Approval Date: 07/06/2021		

**From:** [TEA.NOGA.ACTIONS](#)  
**To:** [James Colbert](#)  
**Cc:** [Jesselyn E. Allen](#); [Lisa Caruthers](#)  
**Subject:** Notice of Preliminary Selection for the 2021-2022 Nita M. Lowey 21st CCLC Cycle 11, Year 1; Request for Application (RFA) #701-21-102  
**Date:** Saturday, June 26, 2021 8:04:12 AM  
**Attachments:** [21st Century Part II Budget Workbook.xlsx](#)

---

TEA is pleased to inform you that your application for **Harris County Department of Education** has been preliminarily selected to receive an award for the **2021-2022 Nita M. Lowey 21st CCLC Cycle 11, Year 1**. The preliminary selection was made after evaluation by external reviewers and agency staff.

**NOTE:** Agency funding of this program is dependent upon a grant of funds by the US Dept. of Education. If the US Dept. of Education fails to grant the necessary funds, the Agency may not fund this program.

### **Confirmation and Negotiations**

Agency staff will thoroughly review each application to confirm that it is compliant with all applicable rules and regulations and that the identified program goals and activities meet the intent of the Request for Application (RFA). Once it is determined that the application is indeed eligible to be funded, agency staff may contact the designated program contact person to negotiate necessary fiscal and programmatic changes to the application. Agency staff will review the budget and activities to determine if the requested amounts are allowable, reasonable, and necessary to meet the intent of the RFA. Budgeted costs determined by TEA to be unallowable, unreasonable, and unnecessary will be removed from the application during the negotiation phase.

If it is determined during the negotiation process that the application is not eligible to be funded, you will be notified of the ineligibility for funding. TEA will not be responsible for paying for any expenditure incurred by the applicant.

Attached you will find the budget workbook needed to complete fiscal negotiations for your award. Please complete at your earliest convenience. DO NOT RETURN YOUR COMPLETED BUDGET UNTIL ASKED TO DO SO.

### **Specific Conditions for Subgrantees Selected Through the Competitive Review Process**

Subgrantees selected through the competitive review process can print their NOGAs after funding is received and before the negotiation process has been completed. This is expected to occur on or after the grant start date of **July 01, 2021**. At that time, grantees may begin accessing up to 20% of the total award. The remaining 80% of the funds will be released upon successful completion of the negotiation process. A final approved copy of your application will be mailed to you as soon as negotiations and all final reviews are complete. To help TEA complete negotiations, please respond to any inquiries from TEA staff as quickly as possible. The NOGA reserve cannot be lifted while any point of negotiation is still pending. TEA also reserves the right to manually review all draw down requests made during the negotiation process.

## **Funding Amounts and Reimbursements**

Please be advised that grantees may not always receive the amount requested in the original application because of revisions made during negotiations and changes to the total amount of funding available. Grantees are responsible for ensuring that any expenditures paid prior to the conclusion of the negotiation process are allowable under the terms and conditions of the grant program. TEA will not make reimbursements for any activities or line items deleted during negotiations. Any refunds incurred while negotiations are ongoing must be paid before the remainder of the grant award is released. These expenses must be paid from other sources. TEA does not give verbal approval for any activities or expenditures.

## **Notice of Grant Award (NOGA)**

NOGAs are expected to be available after funding is received from the US Department of Education. Funding is expected to be received on July 1, 2021.

### **'Print NOGA' feature in the Expenditure Reporting (ER) System**

Copies of the NOGA are no longer attached to notices. A 'Print NOGA' button is available in the ER system to print/view a copy of the Notice of Grant Award (NOGA). Please log on to the ER system to print your award NOGA. Please see below for information on accessing the ER system.

Conditions and requirements of the original SAS and project guidelines remain in effect and are incorporated by reference. All expenditures must occur between the beginning and ending dates on the NOGA. All goods and services purchased with grant funds must be received in time to substantially benefit the project and intended beneficiaries during the grant period for which the funds were awarded.

Thank you for your important efforts for the school kids of Texas. We look forward to working with you during the coming year.

If you have any questions regarding this matter, please contact Competitive Grants at [competitivegrants@tea.texas.gov](mailto:competitivegrants@tea.texas.gov).

ER System information - <https://tea.texas.gov/finance-and-grants/grants/grants-administration/expenditure-reporting>

## **Project Period**

The project period for the above-mentioned grant is stated on your NOGA. All encumbrances and obligations must occur on or between the beginning and ending dates of the subaward unless pre-award costs are expressly permitted for the individual grant program.

In general, goods or services delivered near the end of the grant period may be viewed by TEA as not necessary to accomplish the objectives of the current grant program; however, TEA will evaluate

such expenditures on a case-by-case basis. A TEA monitor or an auditor may disallow those expenditures if the subgrantee is unable to:

1. document the need for the expenditures
2. demonstrate that program beneficiaries receive benefit from the late expenditures, or
3. negate the appearance of “stockpiling” supplies or equipment.

The subrecipient must receive the benefit and liquidate (record as an expenditure) all obligations incurred under the subaward no later than the revised final expenditure report due date. An encumbrance cannot be considered an expenditure or accounts payable until the goods have been received and the services have been rendered. Obligations that are liquidated and recognized as expenditures must meet the allowable cost principles in 2 CFR Part 200 of EDGAR (as applicable) and program rules, regulations, and guidelines contained elsewhere. This provision applies to all grant programs, including state and federal, discretionary and formula.

### **Fingerprinting Requirement**

Per Section 22.0834 of the Texas Education Code (TEC), any person offered employment by any entity that contracts with TEA or receives grant funds administered by TEA (i.e., a subgrantee or a contractor of the subgrantee) is subject to the fingerprinting requirement. TEA is prohibited from awarding grant funds to any entity, including nonprofit organizations, that fails to comply with this requirement. For details, refer to the General and Fiscal Guidelines, Fingerprinting Requirement.

### **Amendments**

If the subgrantee needs to amend the application to request authorization for changes that require approval, the subgrantee must obtain approval from TEA by submitting an amendment prior to the date the subgrantee encumbers such funds and/or such services are rendered. Refer to the “When to Amend the Application” document posted in the Amendment Submission Guidance section of the Administering a Grant page. An amendment is effective on the day it is received by TEA in substantially approvable form yet is subject to negotiation. The last day to submit an amendment to TEA is stated on the TEA Grant Opportunities page.

### **25% Budget Variation Cannot Be Exceeded**

A budget amendment is required when cumulative transfers among direct cost categories exceed or are expected to exceed 25% of the *total current approved budget*. A subgrantee may transfer funds among existing budgeted categories without submitting an amendment as long as the total amount of funds transferred is 25% or less of the total current approved budget. This provision does not allow for the purchase of additional units of equipment, but it does allow for the purchase of previously approved items that cost more than budgeted amounts. The total expenditures for programs budgeted cannot exceed the total amount approved for each program budget.

### **Cash Management Requirements**

The subgrantee must account for and expend federal funds in accordance with federal statute, state laws, and the terms and conditions of the award. There are two methods available to a subgrantee to request payments. These include: reimbursement and cash advances.

- Reimbursement: In a reimbursement method, a subgrantee draws down funds from the ER

system after the subgrantee has already paid the funds. In an effort to allow subgrantees with additional flexibility, TEA has defined reimbursement as drawing down funds on, or after, the day the subgrantee has mailed, delivered, or submitted an electronic payment. For audit purposes, the subgrantee must track the date it mailed, delivered, or submitted an electronic payment as proof for reimbursement method. Under the reimbursement method, a subgrantee is not required to deposit funds in an interest-bearing account.

- **Cash Advance:** Under the cash advance method, a subgrantee draws down funds in advance of when the funds will be paid out. The use of this payment method requires the subgrantee to have written procedures that minimizes the time elapsing between when the subgrantee requests a draw down and when the subgrantee will issue the payment for the program purpose.

### **Requesting Payment through the Expenditure Reporting (ER) System**

Subgrantees in good standing are required to use the ER system to record expenditures and request payment. Subgrantees may generally enter total expenditures by class/object code into the ER system up to 30 days following the ending date of the grant. The subrecipient is responsible for ensuring the Grantee Manager and/or Grantee Official, or such person using the Grantee Manager or Grantee Official's credentials, has been authorized by the subrecipient organization to enter the organization into legally binding agreements for grant payment purposes prior to the Grantee Manager or Grantee Official certifying and submitting expenditure payment requests in the ER system. This authorized official must certify each request for payment as described in 2 CFR §200.415.

### **Accessing ER**

To access ER, all individuals reporting and certifying expenditures are required to have a TEA Login (TEAL) account and access to the ER application. For security purposes, the TEAL username and password are not to be shared with any other user. The ER system is designed to accommodate a segregation of duties between the staff member who enters the drawdown into the ER system and the authorized official who certifies and submits the request. Failure to have such segregation of duties could be a sign of insufficient internal controls indicating risk of inadequate fund management. TEA strongly recommends the segregation of duties and may impose additional specific conditions on subgrant awards when risk is identified.

If you do not have access to TEAL, you must request a user ID. On the TEA Login (TEAL) screen, click Request New User Account and complete the steps provided. A username and temporary password will be emailed to you, so you can logon and finalize your account. Once your TEAL account is finalized, you will logon to TEAL, click on My Application Accounts, and follow the instructions to request access to the Expenditure Reporting application.

If you already have a TEAL account and access to ER, login directly to TEAL. In your list of applications, look for the Expenditure Reporting heading and click on your role/link, under the heading, to access the ER system.

### **Documentation of Expenditures**

For any payment request in ER, TEA reserves the right to request additional supporting



documentation including but not limited to the general ledger, payroll ledger, and copies of payroll checks, invoices, receipts, and travel vouchers before authorizing payment. TEA may request you to upload any such document to your payment request in ER. Payment will not be approved or processed until the requested documentation is received and determined to be allowable under the grant.

### **Expenditure Reporting by Class/Object Code in ER**

Expenditures must be reported in the ER system by class/object code. TEA implements this process to demonstrate compliance with federal monitoring expectations/auditing standards and to mitigate the need for subgrantees that are not identified as high-risk by TEA to submit supporting expenditure documentation for payment requests that exceed grant threshold requirements. High-risk subgrantees are required to submit requested supporting documentation to TEA.

Advance payments must be limited to the minimum amounts needed and be timed to be in accordance with the actual, immediate cash requirements in carrying out the purpose of the approved program or project. The timing and amount of advance payments must be as close as is administratively feasible to the actual disbursements for direct program or project costs and the proportionate share of any allowable indirect costs.

Subgrantees must have written procedures and internal controls for cash management to ensure that only the actual amount of cash needed will be requested, and that the cash received will be paid out. Procedures should show that the subgrantee plans carefully for cash flows for grant projects and reviews cash requirements before each request for payment. Cash management procedures are monitored during monitoring visits and during the annual independent audit.

With any issues or questions related to the programmatic aspects of the grant, please contact the program contact as listed on the TEA Grant Opportunities page.

In addition, the ER system has various system criteria that allow TEA staff to monitor requests for payment. If a draw down request violates an ER system criterion or is randomly selected for monitoring, TEA staff will manually review the draw down request and contact the subgrantee for a narrative payment justification. Payments that do not violate thresholds and/or ER system criteria will be approved automatically.

### **Due Date of Expenditure Report**

The deadline for reporting total final expenditures by class/object code is stated on the TEA Grant Opportunities page.

### **Refunds for Excess Payments**

All refunds for excess payments received (*not for interest earned on federal funds*) must be submitted to:

Texas Education Agency—MSC  
P. O. Box 13717  
Austin TX 78711-3717

Write the name of the grant program, NOGA ID number, and reason for refund ID on the refund

check.

The refund will be credited to the NOGA ID from which the excess funds were drawn down.

Reason for Refund

- R.1. Correction of an administrative error
- R.2. Correction of an unallowable cost
- R.3. Correction for a cost incurred outside the period of availability
- R.4. Return of funds associated with an excessive drawdown
- R.5. Return of funds associated with termination (voluntary or involuntary)
- R.6. Return associated with a failure to meet maintenance of effort
- R.7. Other (*provide brief explanation on separate page*)

**For Assistance**

For funding information, please visit the TEA Grant Opportunities page. If you have any other questions submit them through the TEA Help Desk.

**Denial of Expenditure Reports**

When reporting expenditures by class/object code, the ER system will not permit the subgrantee to submit an expenditure report with the following criteria:

- Where the subgrantee is claiming expenditures in a class/object code not budgeted in the approved application
- When the total amount exceeds the total amount of the grant

**ER Requests Requiring Manual Review and Approval**

Thresholds are established for each grant program to allow for the automatic approval of payments as long as the payments are within the established thresholds. The ER system will automatically forward any request for payment that exceeds the established thresholds to TEA staff for review and approval.

TEA staff will consider each request to exceed the established thresholds on a case-by-case basis.

7/6/2021

Expenditure Rep

Expenditure Report Details

NOGA Information

For questions or problems regarding this NOGA, please contact the Division of Grants Admin. at 512/463-8525

Noga ID: 226950307110022 2021-2022 NITA M. LOWEY 21ST CCLC CYCLE 11 YEAR 1 Status: Approved  
 HARRIS COUNTY DEPT OF EDUCATION Region: 4 Begin Date: 07/01/2021 End Date: 07/31/2022

DUNS: 188326151 CCR: 4AEO1 Congressional District: TX-029 Print NOGA

NOGA Balance Summary

Approved Budget: 1,700,000.00 Cumulative Expenditure: 0.00  
 Total Amount Paid: 0.00 Eligible Remaining: 1,700,000.00

Enter a new Expenditure Report below

Enter reporting period date range

This report type is a

Enter cumulative expenditure amount

From: 07/01/2021 To: Periodic

[Return to Search](#)

Notice The Grant status is either closed or not yet active. Payment request or other transactions cannot be accepted at this time.

[Calculate Indirect Cost](#)

[View TEA Payment Report](#)

Expenditure Report Details

Class Object Code	Description	Program Costs	Direct Administrative Costs	Total
6100	Payroll Costs			0.00
6200	Professional & Contracted Services			0.00
6300	Supplies & Materials			0.00
6400	Other Operating costs			0.00
6600	Capital Outlay (exclusive of 6619 & 6629)			0.00
	Total Direct Costs			0.00
	Indirect Costs( FY 2022 - 12.556 %)			0.00
	Total Project Costs			0.00
6493	Payments to Member Districts of Shared Service Arrangements			0.00

Detail Budget

Class	Description	Program Costs	Direct Administrative Costs	Budgeted Total
6100	Payroll Costs	986,469.00	3,250.00	989,719.00
6200	Professional & Contracted Services	530,531.00	3,250.00	533,781.00
6300	Supplies & Materials	124,000.00	3,250.00	127,250.00
6400	Other Operating costs	46,000.00	3,250.00	49,250.00
6600	Capital Outlay (exclusive of 6619 & 6629)			
	Total Direct Costs	1,687,000.00	13,000.00	1,700,000.00
	Indirect Costs			
	Total Project Costs	1,687,000.00	13,000.00	1,700,000.00

Payment History

Transaction Date	Report Type	Payment Status	Cumulative	Amount	Reserve Pending	Refund Amount	Payment Date	Details
1			0.00	0.00	0.00	0.00		

**Regular Board Meeting**

**8.D.1.**

**Meeting Date:** July 21, 2021

**Title:**

**Submitted For:** Carie Crabb, Therapy

**Submitted By:** Ramielle Leday

**Recommended Action:** Approve

**HCDE Goal(s):** 2. Deliver value responsibly

**Additional Resource Personnel:** Jonathan Parker, Carie Crabb, Dr. Jesus Amezcua, Kendra Jackson

**Facilities/Technology Approval Needed?:** None

**Information**

**Posted Agenda Item:**

**Approval of Interlocal (revenue) contracts for FY 2022 for Therapy Services in the aggregate amount of \$3,573,556 with School-Based Therapy Services and the following districts:** Spring ISD (441 students served in FY20) in the amount of \$999,658; and Katy ISD (1390 students served in FY20) in the amount of \$2,573,898.

**Subject:**

Interlocal (revenue) contracts for School-Based Therapy Services for FY22 with Spring ISD and Katy ISD.

**Rationale:**

HCDE School-Based Therapy Services will provide occupational therapy, physical therapy, and music therapy to Spring ISD and Katy ISD.

**Fiscal Impact**

**Attachments**

Spring ISD Interlocal 2021-2022

Katy ISD Interlocal 2021-2022

**Form Review**

**Inbox**

Carie Crabb  
Purchasing  
Assistant Superintendent - Business  
Form Started By: Ramielle Leday  
Final Approval Date: 07/06/2021

**Reviewed By**

Carie Crabb  
Kendra Jackson  
Venetia Baldwin

**Date**

06/23/2021 05:32 PM  
06/30/2021 08:04 AM  
07/06/2021 09:58 AM  
Started On: 06/23/2021 02:13 PM



School-Based Therapy Services

Interlocal Contract Between Harris County Department of Education and

Spring ISD

Pursuant to the Interlocal Cooperation Act, Chapter 791 of the Texas Government Code, this Interlocal Contract (the "Contract") is made and entered into between Harris County Department of Education ("HCDE") and Spring ISD for the purpose of performing governmental functions and services and to state the terms, rights, and duties of the Contracting parties during the 2021-2022 school year (8/16/2021 - 8/15/2022).

Arrangement

HCDE agrees to provide the services as described below. Spring ISD agrees to pay for the services within thirty (30) days of receiving an invoice for the services.

Table with 4 columns: Type(s) of Service(s), Total Days/Hours, Cost Day/Hour, Total Cost. Rows include Occupational Therapy, Occupational Therapy Assistant, Physical Therapy, Physical Therapy Assistant, Music Therapy, and a TOTAL row.

Additional Terms

- 1. This Contract may be terminated by either party without cause with thirty (30) days advance written notice.
2. This Contract constitutes the sole agreement of the parties relative to the purpose(s) of this Contract...
3. This Contract shall be construed under the laws of the State of Texas...
4. Each party paying for the performance of governmental functions must make those payments from current revenues...
5. Each party acknowledges that this Contract has been authorized by the governing body of each party...
6. Neither this Contract, nor any term or provision hereof, nor any inclusion by reference shall be construed as being for the benefit of any party not in signatory hereof.
7. This Contract does not create a joint venture or business partnership under Texas law.
8. The total amount of this Contract is an estimate based on data provided by both parties.
9. In the event that the District makes a payment to HCDE with a credit card, the District agrees to pay to HCDE a surcharge fee...
10. HCDE will make every attempt to provide the number of days as indicated, however, some alterations in the staffing...
11. In accordance with Senate Bill 9, HCDE submits fingerprints to the State Board for Educator Certification (SBEC)...
12. Harris County Department of Education adheres to the Uniform Grant Guidance as codified in 2 CFR Part 200...

Agreed to: [Signature]
Superintendent/Designee
Date 6/9/21

James Colbert, Jr., County School Superintendent
Date

For HCDE office use only:
Revenue Account No. 199-2-00-111-00-111-5726-0000

Contract Code TS 53950



James Colbert, Jr., County School Superintendent
6300 Irvington Boulevard \* Houston, Texas 77022 \* Tel: 713.696.6300 \* www.hcde-texas.org

**Interlocal Contract Between  
Harris County Department of Education and  
Katy Independent School District**

Pursuant to the Interlocal Cooperation Act, Chapter 791 of the Texas Government Code, this Interlocal Contract (the "Contract") is made and entered into between Harris County Department of Education ("HCDE") and Katy ISD for the purpose of performing governmental functions and services and to state the terms, rights, and duties of the Contracting parties during the 2020-2021 school year (9/01/2021 – 8/31/2022).

**Arrangement**

HCDE agrees to provide the services as described below. Katy ISD agrees to pay for the services within thirty (30) days of receiving an invoice for the services.

<u>Type(s) of Service(s)</u>	<u>Total Days/Hours</u>	<u>Cost Day/Hour</u>	<u>Total Cost</u>
<u>Occupational Therapy</u>	<u>3556</u>	<u>\$482/Day</u>	<u>\$1,713,992.00</u>
<u>Occupational Therapy Assistant</u>	<u>805</u>	<u>\$380/Day</u>	<u>\$305,900</u>
<u>Physical Therapy</u>	<u>711</u>	<u>\$482/Day</u>	<u>\$342,702</u>
<u>Physical Therapy Assistant</u>	<u>167</u>	<u>\$380/Day</u>	<u>\$63,460</u>
<u>Music Therapy</u>	<u>276</u>	<u>\$482/Day</u>	<u>\$133,032</u>
<u>Occupational Therapy ESY</u>	<u>14</u>	<u>\$482/Day</u>	<u>\$6,748</u>
<u>Occupational Therapy Assistant ESY</u>	<u>6</u>	<u>\$380/Day</u>	<u>\$2280</u>
<u>Physical Therapy ESY</u>	<u>12</u>	<u>\$482/Day</u>	<u>\$5784</u>
<b><u>TOTAL</u></b>			<b><u>\$2,573,898.00</u></b>

**Additional Terms**

1. This Contract may be terminated by either party without cause with thirty (30) days advance written notice. HCDE's obligations under this Contract are contingent on it acquiring and maintaining sufficient staffing through reasonable efforts to satisfy its obligations under this Contract and all similar obligations under its contracts with other districts. In the event of termination, Katy ISD will compensate HCDE for services provided up to the termination date.
2. This Contract constitutes the sole agreement of the parties relative to the purpose(s) of this Contract and supersedes any other oral or written understandings or agreements. This Contract may only be amended in writing with the consent of both parties. This Contract is not assignable.
3. This Contract shall be construed under the laws of the State of Texas and mandatory and exclusive venue in any action arising out of this Contract shall be in Harris County, Texas.
4. Each party paying for the performance of governmental functions must make those payments from current revenues available to the paying party.
5. Each party acknowledges that this Contract has been authorized by the governing body of each party to the Contract.
6. Neither this Contract, nor any term or provision hereof, nor any inclusion by reference shall be construed as being for the benefit of any party not in signatory hereof.
7. This Contract does not create a joint venture or business partnership under Texas law.
8. The total amount of this Contract is an estimate based on data provided by both parties. Invoices will be sent by HCDE for services rendered during the term of this agreement.
9. In the event that the District makes a payment to HCDE with a credit card, the District agrees to pay to HCDE a surcharge fee consisting of any applicable credit card fees and costs borne by HCDE, including, without limitation, the processing fee(s) charged to HCDE by the credit card company(ies).
10. HCDE will make every attempt to provide the number of days as indicated, however, some alterations in the staffing within an individual discipline may be necessary. No changes to the staffing will be made without mutual written consent. In no case will the dollar amount of the contract be exceeded without a formal contract amendment.
11. In accordance with Senate Bill 9, HCDE submits fingerprints to the State Board for Educator Certification (SBEC) on all new employees, and pursues criminal history background checks annually on all HCDE employees.
12. Harris County Department of Education adheres to the Uniform Grant Guidance as codified in 2 CFR Part 200, otherwise known as Edgar Department General Administrative Regulations (EDGAR).

Agreed to: [Signature]  
 Superintendent/Designee  
 Date 5/18/21

\_\_\_\_\_  
 James Colbert, Jr., County School Superintendent  
 Date \_\_\_\_\_

For HCDE office use only:  
 Revenue Account No. 199-2-00-111-00-111-5726-0000

Contract Code TS35800

**Regular Board Meeting**

**8.D.2.**

**Meeting Date:** July 21, 2021  
**Title:** Interlocal Agreement with Spring Branch ISD School Safety Audits  
**Submitted For:** Julia Andrews, Center for Safe and Secure Schools  
**Submitted By:** Gil Gaona  
**Recommended Action:** Approve

**HCDE Goal(s):**  
2. Deliver value responsibly  
4. Provide cost savings by leveraging tax dollars

**Additional Resource Personnel:** Julia Andrews, Dr. Jesus Amezcua, Kendra Jackson  
**Facilities/Technology Approval Needed?:**

**Information**

**Posted Agenda Item:**

**Approval of Interlocal (revenue) contract with Spring Branch ISD and the Center for Safe and Secure Schools Division for School Safety Audits over a two-year cycle** (July 26, 2021 through June 30, 2023) in an amount not to exceed \$70,268, servicing 62 sites.

**Subject:**

Conduct school safety audits for Spring Branch ISD

**Rationale:**

Conduct school safety audits for Spring Branch ISD over a two year cycle in the amount of \$70,268.

**Fiscal Impact**

**Attachments**

Spring Branch ISD Interlocal

**Form Review**

**Inbox**

julia Andrews  
Purchasing  
Assistant Superintendent - Business  
Assistant Superintendent - Business  
Form Started By: Gil Gaona  
Final Approval Date: 07/07/2021

**Reviewed By**

Karla Cantu  
Kendra Jackson  
Venetia Baldwin  
Jesus Amezcua

**Date**

06/28/2021 11:22 AM  
06/30/2021 08:21 AM  
07/06/2021 09:58 AM  
07/07/2021 11:41 AM  
Started On: 06/28/2021 10:13 AM

**Interlocal Agreement  
between  
Harris County Department of Education  
& Spring Branch Independent School District (SBISD)**

Pursuant to the Interlocal Cooperation Act, Chapter 791 of the Texas Government Code, and Chapter 271, Subchapter F of the Texas Local Government Code, this Interlocal Agreement (“Agreement”) is made and entered into by and between Harris County Department of Education (“HCDE”), located in Houston, Texas, and Spring Branch Independent School District (SBISD), a public school district (“District”), located in Houston, Texas 77024, for the purpose of contracting for the performance of governmental functions and services. The undersigned may be referred to in this Agreement individually as a “Party” and collectively as the “Parties.”

**Preamble**

HCDE is a local governmental entity established to promote education in Harris County, Texas and is duly authorized to provide programs and services in the State of Texas, including safety and security services through its Center for Safe and Secure Schools (“CSSS”). Both HCDE and the District desire to set forth, in writing, the terms and conditions of their agreement.

**General Terms and Conditions**

In consideration of the mutual covenants and conditions contained in this Agreement and other good and valuable consideration, the receipt and sufficiency of which are hereby acknowledged, the parties, intending to be legally bound, agree as follows:

1. **Term.** The term of this Agreement shall commence on the date on which all Parties have executed this Agreement (“Effective Date”) and shall end on **June 30, 2023**, unless earlier terminated in accordance with Article 10 herein.
2. **Agreement.** The terms of this Agreement shall apply and will be considered a part of any addendum, purchase order, or contract for programs and services delivered by HCDE. This Agreement and the attached and incorporated addenda, purchase orders, or exhibits, if any, contain the entire agreement of the parties, and there are no representations, agreements, arrangements, or undertakings, oral or written, between the Parties to this Agreement other than those set forth in this Agreement and duly executed in writing.
3. **Purpose and Scope of Work.**
  - A. **HCDE agrees to:**
    - Provide services of staff members and/or consultants of the CSSS for the purpose of providing safety and security services that will be considered by the Superintendent and Board of Trustees of the District to determine possible changes in equipment, systems, services, training, and procedures for the District.
    - Conduct Safety and Security Audits (“Audits”) of the District’s facilities as listed in Exhibit A, Scope of Work. The scope of each Audit shall include the services as set forth in Exhibit A.
    - Provide Audit Final Reports and draft reports containing Audit findings, recommendations, and commendations in accordance with Exhibit A.
  - B. **The District agrees to:**
    - Select District facilities in which to conduct Audits and provide the list of facilities in Exhibit A.



- Provide data, access to District facilities, and any other information requested by HCDE needed to conduct the Audits in accordance with the terms of this Agreement, as determined by HCDE.
4. As is. HCDE makes this Agreement available to HCDE participating entities “as is” and is under no obligation to revise the terms, conditions, scope, prices, and/or any requirements of the Agreement for the benefit of the District.
  5. Fees. The total fee for Audits provided in accordance with Exhibit A is **\$70,268.00**. The fees included in this Agreement are based on services to address general requirements and the efficient delivery of services. Additional specifications, schedule changes, and/or facilities requested by the District may incur additional fees, as determined by HCDE. HCDE shall provide written notice of any such increase in fees, and the Parties shall set forth the addition of such fees in writing as an addendum to this Agreement.
  6. Payments. The Parties agree that all payments made under this Agreement will be in an amount that fairly compensates the performing Party for the services or functions performed under this Agreement. The Parties further agree that each Party paying for the performance of governmental functions or services pursuant to this Agreement must make those payments from current revenues available to the paying Party.
  7. Invoices. HCDE will invoice the District as services are completed for each phase of the project as follows:

<b>Year 1</b>	<b>\$37,776.00</b>
<b>Year 2</b>	<b>\$32,492.00</b>

- The District agrees to remit payment to HCDE within thirty (30) days after the date the District receives an invoice for the services. If the District makes a payment to HCDE with a credit card, the District agrees to pay to HCDE a surcharge fee consisting of any applicable credit card fees and/or costs incurred by HCDE, including, without limitation, the processing fee(s) charged to HCDE by the credit card company(ies).
8. Compliance with Laws. Each Party is responsible for complying with applicable laws and regulations relating to this Agreement.
  9. Confidentiality: To the extent allowable by law, HCDE agrees to maintain the confidentiality of all records to which it has access while performing Audits pursuant to this Agreement. Unless disclosure is required by applicable law, HCDE further agrees that all findings and reports created by HCDE under this Agreement are confidential and shall not be disclosed to anyone other than District officials without the written approval of the District.
  10. Termination. This Agreement may be terminated prior to the expiration of the Term hereof as follows:
    - By either Party, with or without cause, upon thirty (30) days’ prior written notice.
    - By mutual written agreement of the Parties; or

- By either Party immediately if the other Party commits a material breach of any of the terms of this Agreement and no remedial action can be agreed upon by the Parties.

In the event of termination of this Agreement, the District shall be responsible for compensating HCDE for services provided by HCDE up to the effective date of termination and shall be paid within thirty (30) days of the effective date of termination.

11. Assignment. Neither this Agreement nor any duties or obligations under this Agreement shall be assignable by either party without the prior written acknowledgment and authorization of both parties.
12. Conflict of Interest. During the Term of HCDE's service to the District, the District, its personnel and agents, shall not, directly or indirectly, whether for the District's own account or with any other person or entity whatsoever, employ, solicit or endeavor to entice away any person who is employed by HCDE.
13. Contract Amendment. This Agreement may be amended only by the mutual agreement of all Parties, in writing, to be attached to and incorporated into this Agreement.
14. Notice. Any notice provided under the terms of this Agreement by either party to the other shall be in writing and shall be sent by **certified mail, return receipt requested**. Notice to shall be sufficient if made or addressed as follows:

Harris County Department of Education  
 Attn: James Colbert, Jr.  
 County School Superintendent  
 6300 Irvington Blvd.  
 Houston, Texas 77022  
 713-694-6300

Spring Branch Independent School District  
 (District)  
 Attn: Richard L. Gay  
 Title: Director, Procurement Services  
 Address: 955 Campbell Road, Houston, TX  
 City, State, Zip: 77024  
 Phone: 713-251-1106  
 Email: [Richard.gay@springbranchisd.com](mailto:Richard.gay@springbranchisd.com)

15. Relation of Parties. It is the intention of the parties that the District is independent of HCDE and not an employee, agent, joint venturer, or partner of HCDE and nothing in this Agreement shall be interpreted or construed as creating or establishing the relationship of employer and employee, agent, joint venturer or partner, between HCDE and the District or HCDE and any of the District's representatives.
16. Non-Exclusivity of Services. Nothing in this Agreement may be construed to imply that HCDE has exclusive right to provide the District with programs or services. During the Term of this Agreement, the District reserves the right to use all available resources to procure other programs and services as needed and, in doing so, will not violate any rights of HCDE.
17. Disclaimer. HCDE DOES NOT WARRANT THAT THE OPERATION OR USE OF HCDE PROGRAMS AND/OR SERVICES WILL BE UNINTERRUPTED OR ERROR FREE. HCDE HEREBY DISCLAIMS ANY AND ALL WARRANTIES, EXPRESS OR IMPLIED, IN REGARD TO ANY INFORMATION, PRODUCT, PROGRAM, OR SERVICE FURNISHED UNDER THIS AGREEMENT, INCLUDING, WITHOUT

LIMITATION, ANY AND ALL IMPLIED WARRANTIES OF MERCHANTABILITY OR FITNESS FOR A PARTICULAR PURPOSE.

HCDE is not a regulatory agency and interprets regulations as a regulated political subdivision. Audits performed in accordance with this Agreement are limited to the data, information, and access provided by the District to HCDE, and HCDE does not warrant that Audits conducted hereunder will uncover every security concern, area of needed improvement, or any other category of information examined by HCDE. Audits conducted by HCDE are intended as one source, among other sources, for use by the District in determining the safety and security of its facilities. Successful completion of Audits under this Agreement will support partial satisfaction of the District's compliance with current statutory requirements as set forth in Texas Senate Bill 11 in September 2011.

18. Limitation of Liability. Without waiver of the Disclaimer in Article 16 of this Agreement, the Parties agree that:
  - Neither Party waives any immunity afforded to it under applicable law; and
  - Neither Party shall be liable to the other Party for special, incidental, or exemplary damages with regard to any lawsuit or formal adjudication arising out of or relating to this Agreement.
19. Severability. In the event that any one or more of the provisions contained in this Agreement shall for any reason be held to be invalid, illegal, or unenforceable in any respect, such invalidity, illegality, or unenforceability shall not affect any other provisions, and the Agreement shall be construed as if such invalid, illegal, or unenforceable provision had never been contained in it.
20. Governing Law and Venue. This Agreement shall be governed by and construed in accordance with the laws of the State of Texas, without regard to its conflicts of laws provisions. The mandatory and exclusive venue for the adjudication or resolution of any dispute arising out of this Agreement shall be in Houston, Harris County, Texas, and the Parties hereby submit to the exclusive jurisdiction of said courts.
21. No Waiver. Nothing in this Agreement shall be deemed to waive, modify, or amend any legal defense available at law or equity to a Party, including the defense(s) of immunity. No failure on the part of either Party at any time to require the performance by the other Party of any term hereof shall be taken or held to be a waiver of such term or in any way affect such Party's right to enforce such term, and no waiver on the part of either Party of any term hereof shall be taken or held to be a waiver of any other term hereof or the breach thereof. No waiver, alteration, or modification of any of the provisions of this Agreement shall be binding unless in writing and signed by duly authorized representatives of the Parties hereto.
22. Benefit for Signatory Parties Only. Neither this Agreement, nor any term or provisions hereof, not any inclusion by reference, shall be construed as being for the benefit of any party not in signatory hereto.
23. Authorization. Each party acknowledges that the governing body of each Party to the Agreement has authorized and approved this Agreement.

24. Counterparts. This Agreement may be executed in any number of counterparts, each of which shall be deemed an original constituting one and the same instrument.

In witness whereof, HCDE and the District have executed this Agreement to be effective on the date specified in Article 1. Term above:

Spring Branch Independent School District      Harris County Department of Education  
District Name

Richard L Gay      \_\_\_\_\_  
Authorized Signature

Richard L Gay      James Colbert, Jr.  
Printed Name

Director, Procurement Services      County School Superintendent  
Title

5/21/2021      \_\_\_\_\_  
Date      Date

**EXHIBIT A  
Scope of Work**

1. **Selected Facilities**  
 HCDE will conduct Safety and Security Audits (“Audits”) of the facilities listed below, as selected by the District:

<b>Timeline</b>	<b>Number of Sites</b>	<b>Site Names/Types</b>
Year 1 2021-22 SY	33	14 Elementary Schools, 3 Junior Schools, 4 High Schools, 3 Early Childhood Centers and 9 Support Services
Year 2 2022-2023 SY	29	14 Elementary Schools, 2 Junior Schools, 3 High Schools, 2 Early Childhood Centers and 8 Support Services

2. **Scope of Audits**  
 The scope of each Audit includes:
1. Approach of the school/site *unannounced* to determine how freely HCDE team members can move about the building and interact with students and employees without being challenged by District officials (If necessary, the District will provide HCDE team members with written authorization to assess the schools with a campus escort).
  2. Observation of the number, location, and condition of surveillance cameras, and potential security factors relating to building entrances, stairwells, areas out of sight of usual adult vision, and other “high risk” locations.
  3. Conference with the counselor, principal, and other staff to determine training and skilled, instituted procedures regarding safety and security.
  4. Determination of the structure of the District’s crisis response/recovery team.
  5. Review of District-wide procedures, communication processes, and the climate of assessed sites.
  6. Identification of any District research initiatives or networking efforts with other schools/and or districts.

3. **Reports**  
 After each site visit has been completed, HCDE will conduct a debriefing with key facility staff. At a later date, HCDE will provide a facility-specific draft report containing Audit findings, recommendations, and commendations and an Executive Summary for the Superintendent or designee. All such drafts reports are considered to be drafts and works in progress, to the extent permitted by law. The Audit Final Report will be provided to the Superintendent or designee and is designed to provide the District with a useful and strategic planning tool.

Within six to eight (6-8) weeks of the Audit Final Report, the District is encouraged to respond in writing to HCDE regarding how it proposes to address recommendations contained in the Audit Final Report, which may include a decision to implement a modified or altered recommendation(s) and/or not implement recommendation(s). HCDE’s team can assist District officials and principals in the development of a written response, at the request of the District.

**EXHIBIT B**  
**List of Facilities**

<b>Elementary School</b>	<b>Middle School</b>	<b>High School</b>	<b>Support Facilities/Early Childhood Facilities</b>
<ol style="list-style-type: none"> <li>1. Bendwood Campus</li> <li>2. Buffalo Creek</li> <li>3. Bunker Hill</li> <li>4. Cedar Brook</li> <li>5. Edgewood</li> <li>6. Frostwood</li> <li>7. Hollibrook</li> <li>8. Housman</li> <li>9. Hunters Creek</li> <li>10. Landrum</li> <li>11. Meadow Wood</li> <li>12. Memorial Drive</li> <li>13. Nottingham</li> <li>14. Pine Shadows</li> <li>15. Ridgecrest</li> <li>16. Rummel Creek</li> <li>17. Shadow Oaks</li> <li>18. Sherwood</li> <li>19. South Transition (Hunters Creek)</li> <li>20. Spring Branch</li> <li>21. Terrace</li> <li>22. Thornwood</li> <li>23. Treasure Forest</li> <li>24. Valley Oaks</li> <li>25. Westchester</li> <li>26. Westwood</li> <li>27. Wilchester</li> <li>28. Woodview</li> </ol>	<ol style="list-style-type: none"> <li>1. SB Academy of Choice</li> <li>2. Memorial</li> <li>3. Northbrook</li> <li>4. Spring Wood</li> <li>5. Stratford</li> </ol>	<ol style="list-style-type: none"> <li>1. Cornerstone Academy</li> <li>2. Memorial</li> <li>3. Northbrook</li> <li>4. Spring Branch</li> <li>5. Spring Forest</li> <li>6. Spring Oaks</li> <li>7. Spring Woods</li> </ol>	<ol style="list-style-type: none"> <li>1. SBISD Admin Bldg</li> <li>2. Child Nutrition/Warehouse</li> <li>3. Guthrie Center – ITV TSDC</li> <li>4. Guthrie Center</li> <li>5. WW Emmons Natatorium</li> <li>6. Planning &amp; Construction/Bldg</li> <li>7. Purchasing/Central Warehouse</li> <li>8. Reggie Grob Stadium</li> <li>9. SBISD Police Command Station</li> <li>10. Support Center – Robert A Vines</li> <li>11. Support Center DEAP Assessment</li> <li>12. Support Center – East Transition (Abandoned)</li> <li>13. Tax Office</li> <li>14. Technology Training Center</li> <li>15. Transportation</li> <li>16. Darrell Tully Stadium</li> <li>17. West Support Center</li> </ol> <ol style="list-style-type: none"> <li>1. Bear Blvd</li> <li>2. Lion Lane</li> <li>3. Panda Path</li> <li>4. Tiger Trail</li> <li>5. Wildcat Way</li> </ol>

**Regular Board Meeting****8.D.3.**

**Meeting Date:** July 21, 2021  
**Title:** Schools Division Academic and Behavior School East Annual Contracts FY22: La Porte (7); Spring (12)  
**Submitted For:** Anthony Mays, Schools  
**Submitted By:** Denise Alamos  
**Recommended Action:** Approve  
**HCDE Goal(s):** 2. Deliver value responsibly  
**Additional Resource Personnel:** Jonathan Parker, Charles Ned, Dr. Jesus Amezcua, Kendra Jackson  
**Facilities/Technology Approval Needed?:**

**Information****Posted Agenda Item:**

**Approval of Interlocal (revenue) contract for FY 2022 in the aggregate amount of \$391,495 with Academic and Behavior School East with the following district:** La Porte ISD for seven (7) in-county annual contracts in the amount of \$144,235 (\$20,605 each); Spring ISD for twelve (12) in-county annual contracts in the amount of \$247,260 (\$20,605 each); for the contract period of 8/23/2021 through 06/03/2022.

**Subject:**

Interlocal (revenue) contract for **FY 2022 in the aggregate amount of \$391,495 with Academic and Behavior School East with the following district:** La Porte ISD for seven (7) in-county annual contracts in the amount of \$144,235 (\$20,605 each); Spring ISD for twelve (12) in-county annual contracts in the amount of \$247,260 (\$20,605 each); for the contract period of 8/23/2021 through 06/03/2022.

**Rationale:**

Entity	Description	Dates	Total
La Porte ISD	Annual Contract (7) (in-county \$20,605 each)	8/23/21-6/3/22	\$144,235
Spring ISD	Annual Contract (12) (in-county \$20,605 each)	8/23/21-6/3/22	\$247,260
<b>Total</b>			<b>\$391,495</b>

**Fiscal Impact**

**Included in FY budget Y/N:** Y  
**Included in current budget amendment Y/N:** N

**Attachments**

FY22 ABSE-Annual Contract La Porte ISD-7\_ \$144,235  
 FY22 ABSE-Annual Contract Spring ISD 12\_ \$247,260

**Form Review**

<b>Inbox</b>	<b>Reviewed By</b>	<b>Date</b>
Purchasing	Kendra Jackson	07/06/2021 12:48 PM
Assistant Superintendent - Business	Jesus Amezcua	07/09/2021 03:54 PM
Form Started By: Denise Alamos		Started On: 06/28/2021 02:11 PM
Final Approval Date: 07/09/2021		



**INTERLOCAL AGREEMENT FOR SPECIALIZED SERVICES  
ACADEMIC BEHAVIOR SCHOOL (ABS) EAST**

**2021-2022 ANNUAL CONTRACT**

Pursuant to the Interlocal Cooperation Act, Chapter 791 of the Texas Government Code, Harris County Department of Education (“HCDE”) and the **La Porte Independent School District**, (“**LPISD**”) hereby enter into an Interlocal Contract (“Contract”) for the purpose of providing educational and related services for eligible student(s) with disabilities of the **LPISD** and to state the terms, rights and duties of the contracting parties.

1. **Term.** This Contract is for the term of **August 23, 2021** through **June 3, 2022**. During said term, HCDE agrees to provide services described herein for **seven (7) total: Adaptive Behavior Program/LIFE Skills Program** unit(s) to eligible student(s) with disabilities (“Student(s)”) who are residents of the **LPISD**.
2. **HCDE Responsibilities.**
  - a) HCDE agrees to provide specialized facilities and certified/licensed personnel necessary to provide educational, instructional, and counseling services to the student(s) placed at ABS East in accordance with applicable law and during the days and times set forth by ABS East. HCDE may perform the services contracted for herein by using its own employees or independent contractors. HCDE will use its best efforts to provide the necessary specialized facilities and properly certified/licensed personnel in accordance with applicable law.
  - b) HCDE agrees to furnish the **LPISD** with a monthly statement of student(s) attendance. HCDE agrees to furnish **LPISD** with documentation of restraints within two (2) HCDE school days. HCDE will provide documentation of restraint procedures upon request by **LPISD**.
  - c) HCDE may provide transportation for the student(s) to and from field trips, vocational training, and similar activities, if written permission allowing HCDE to transport students is provided by the students’ parents/guardians.
  - d) HCDE agrees to maintain necessary records and accounts in order to assure that funds received from the **LPISD** have been expended for the services described herein. HCDE agrees to provide these records and other information as may be required by the **LPISD**.
3. **LPISD’s Responsibilities.**
  - a) **LPISD** is responsible for providing transportation for the student(s) to and from ABS East. Location of pick-up and drop-off points and time of service will be mutually determined by representatives of **LPISD** and HCDE.
  - b) **LPISD** shall provide copies of all Student Records (as hereinafter defined) pertaining to the student(s) no later than five (5) HCDE business days prior to student(s)’s first day of attendance at ABS East. **LPISD** agrees to furnish HCDE a copy of any additional pertinent documents regarding the student(s) that may be requested from or obtained by **LPISD** during the term of this Contract. **LPISD** shall provide copies of additional records, including **LPISD** Records, as reasonably requested by HCDE.
  - c) **LPISD** retains the responsibility to report **LPISD** student(s)’s average daily attendance and other required information through the Public Education Information Management System (“PEIMS”).
4. **Student Records; Confidentiality.**

For purposes of this Contract, “Student Records” shall be defined as student information including personal identifiers such as name, address, phone number, date of birth, Social Security number, and student identification number, and any student information protected by law, including “personally identifiable information” and student “education records” as those terms are defined by the Family Educational Rights and Privacy Act, 20 USC 1232g, as amended (“FERPA”); “personal information” as that term is defined in the Children’s Online Privacy Protection Act of 1998 (“COPPA”); “personal information” as that term is defined in the Protection of Pupil Rights Amendment (“PPRA”); “personally identifiable information” as that term is defined in the Individuals with Disabilities Education Act, as amended (“IDEA”); “protected health information” as that term is defined in the Health Insurance



Portability and Accountability Act of 1996 (“HIPAA”); and “personal identifying information” and “sensitive personal information” as defined under the Texas Identity Theft Enforcement and Protection Act (Chapter 521, Texas Business and Commerce Code).

Notwithstanding any contrary provision of this Contract, both Parties and their employees, agents, and subcontractors may access and use Student Records only as permitted by law for the purpose(s) for which the disclosure was made. Both Parties agree to abide by FERPA’s limitations and requirements imposed on school officials, including, but not limited to, the requirements of 34 C.F.R. 99.33(a). HCDE and **LPISD** expressly agree that: (1) the services/functions to be provided by HCDE are services/functions for which **LPISD** would otherwise use its own employees; (2) both Parties have been determined to meet the criteria set forth in **LPISD**’s annual notification of FERPA rights for being school officials with legitimate educational interests in the Student Records; (3) **LPISD** is under HCDE’s direct control with respect to **LPISD**’s access to, use of, and disclosure of Student Records as gathered and maintained by HCDE; (4) HCDE is under **LPISD**’s direct control with respect to HCDE’s access to, use of, and disclosure of Student Records as gathered and maintained by HCDE; and (5) both Parties will use Student Records only for authorized purposes and will not re-disclose Student Records to other parties, unless each Party has specific authorization from the other Party to do so or the disclosure is otherwise permitted by applicable law, including without limitation, FERPA, HIPAA, COPPA, IDEA, PPRA and the Texas Identity Theft Enforcement and Protection Act.

**5. Immunity.**

Nothing in this Contract shall be construed as a waiver or relinquishment of any governmental immunities or defenses on behalf of either Party or their respective trustees, officers, employees, and agents as a result of the execution of this Contract or performance of the functions or obligations described herein.

**6. Collaboration.** Both Parties agree to collaborate, as necessary, to administer the services described in this Contract and to act in the best interest of the student(s). Both Parties shall use collaborative problem-solving techniques and best efforts to resolve issues between the Parties as they may arise.

**7. Special Education Services.**

- a) Special education student(s) served under this Contract have been placed by the Admission, Review and Dismissal (ARD) Committee of the student(s)’s school of regular attendance within **LPISD** and recommended for services as described herein. The ARD Committee of **LPISD** has affirmed the classification and approved the recommendation of such contracted services.
- b) HCDE will be available for participation with the **LPISD** ARD Committee in the development of the Individualized Education Plan (IEP). HCDE will update the **LPISD** on the implementation of the IEP at least once per semester. A member of the **LPISD** special education personnel will monitor, assess and evaluate the student(s)’s progress as established by the IEP, including at least one on-site visit annually.
- c) HCDE will follow the IDEA and other applicable laws when considering dismissal and/or expulsion of a qualified special education student(s) from ABS East.
- d) **LPISD** agrees to invite an HCDE representative as a non-consensus member to any **LPISD** ARD Committee meeting for **LPISD** student(s) placed at ABS East pursuant to this Contract.
- e) HCDE will not use prohibited aversive techniques, as that term is defined by Texas Education Code § 37.0023.

**8. Local Education Agency.**

Student(s) receiving services from HCDE pursuant to this Contract remain enrolled in **LPISD** and are considered students of **LPISD** for all purposes. ISD remains the Local Education Agency (“LEA”), as that term is defined by the IDEA, and the “Recipient” as that term is defined by Section 504 of the

Rehabilitation Act of 1973 (“Section 504”), and solely retains the obligation to provide and to ensure that any eligible **LPISD** student is provided a free appropriate public education (“FAPE”) while receiving services from HCDE. **LPISD** retains all responsibilities required of the LEA pursuant to the IDEA, and required of the Recipient pursuant to Section 504, including, but not limited to, requirements regarding identification, evaluation, educational placement, the provision of FAPE, and procedural safeguards. For any dispute, including a special education complaint or due process hearing, arising under the IDEA, Section 504, or other applicable law regarding an **LPISD** student placed at HCDE, **LPISD** recognizes and acknowledges that HCDE is not the LEA or Recipient for the **LPISD** student and is in no way liable to the student, parent, or **LPISD** under the IDEA, Section 504, or other applicable law.

9. **Invoices and Payment.** In consideration of the services provided herein, **LPISD** agrees to pay HCDE a total amount of **\$144,235**. Total amount is calculated by multiplying the number of units times the annual **in-county** tuition rate (**\$20,605**).

HCDE will invoice **LPISD** and payment will be due immediately upon receipt of invoice. **LPISD** agrees to pay HCDE in the following manner:

- 50% of annual total amount due will be invoiced in **September 2021**
- 50% of annual total amount due will be invoiced in **January 2022**

If applicable, in consideration of Extended School Year Services (ESY) provided, **LPISD** agrees to pay HCDE in the following manner:

- \$5,278 in-county tuition rate times number of ESY students enrolled.
  - 100% of ESY total amount due will be invoiced in **July 2022**.
- a) In the event that **LPISD** makes a payment to HCDE with a credit card, **LPISD** agrees to pay to HCDE a surcharge fee consisting of any applicable credit card fees and costs borne by HCDE, including, without limitation, the processing fee(s) charged to HCDE by the credit card company(ies).
  - b) **LPISD** may sell unused units to another district upon obtaining HCDE’s prior written consent.
  - c) Each Party paying for the performance of governmental functions and/or invoices must make those payments from current revenues available to the paying Party.
  - d) The source of funding for this contract will be from **LPISD** \_\_\_\_\_ (federal, state or local) funds. The parents of the student(s) shall not be charged for the services contracted under this Contract.

10. **LPISD Liaison.** **LPISD** shall appoint a qualified liaison to communicate on behalf of **LPISD** with HCDE representatives. The liaison shall be knowledgeable in no less than the student(s)’s educational and disciplinary records; ABS East programs, policies, and procedures; and special education law, policies, and procedure, if appropriate. The **LPISD** liaison shall make best efforts to assist ABS East representatives in providing services to students, including, but not limited to, acquiring information regarding the student(s), assessing best placement, and communicating with **LPISD** employees and student(s)’s parents/guardians, as necessary.

11. **Termination.**

- a) HCDE shall have the right to terminate this Contract for convenience, effective at the end of the Term, or with at least thirty (30) calendar days prior written notice to **LPISD**’s. If HCDE exercises such termination right, HCDE shall have no obligation to refund to **LPISD** the amount of any pre-paid fees for any period following the effective date of such termination.
- b) Both Parties may terminate this Contract with or without cause by mutual written agreement.
- c) Upon the effective date of termination or expiration of this Contract, except as otherwise explicitly stated herein, the Parties shall have no obligations to the other Party under this Contract. Student(s) in attendance at ABS East at the time of termination or expiration of this Contract will return to **LPISD**’s. All Student Records maintained by HCDE during the duration of providing services to the

student will be provided to **LPISD** within ten (10) business days following the date of termination or expiration, at the written request of **LPISD's**.

- 12. Equal Opportunity.** It is the policy of HCDE not to discriminate on the basis of race, color, national origin, gender, limited English proficiency or handicapping conditions in its programs. **LPISD** agrees not to discriminate against any employee, student(s), or other person or party in the performance of this Contract, with respect to placement at ABS East, services to be provided, conditions and privileges of employment, or a matter directly or indirectly related to age (except where based on a bona fide occupational qualification), sex (except where based on a bona fide occupational qualification), race, color, religion, national origin, or ancestry. Breach of this covenant may be regarded as a material breach of this Contract.
- 13. Assignment.** Neither this Contract nor any duties or obligations under it shall be assignable by either Party without the prior written acknowledgment and authorization of the other Party.
- 14. Notice.** Any notice provided under the terms of this Contract by either Party to the other shall be in writing and shall be deemed sufficient forty-eight (48) hours after being deposited in the regular mail as certified mail, return receipt requested, if such notice is addressed to the party to be notified at such Party's address as set forth below:

**HCDE**

Attention: James Colbert, Jr., County School Superintendent  
6300 Irvington Boulevard  
Houston, Texas 77022-5618

**LPISD's**

Attention: Dr. Walter Jackson, Superintendent  
1002 San Jacinto St.  
La Porte, Texas 77571

Each Party may change the address at which notice may be sent to that Party by giving notice of such change to the other Party in accordance with the provisions of this Article.

- 15. Third Party Beneficiaries.** Nothing in this Contract shall be deemed or construed to create any third-party beneficiaries or otherwise give any third party any claim or right of action against any party to this Contract.
- 16. Choice of Law and Venue.** This Contract shall be construed under the laws of the State of Texas, and mandatory and exclusive venue for any action arising out of this Contract shall be in Harris County, Texas.
- 17. Amendments and Waivers.** Any term of this Contract may be amended or waived only with the written consent of the Parties or their respective permitted successors and assigns. Any amendment or waiver effected in accordance with this Article shall be binding upon the Parties and their respective successors and assigns.
- 18. Separate Entities.** There is no relationship of agency, partnership, joint venture, employment, or franchise between the Parties. Neither Party has the authority to bind the other or to incur any obligation on its behalf. **LPISD** assumes full responsibility for the actions of its personnel while performing any services incident to this Contract, including, but not limited to, transportation and special education services, and shall remain solely responsible for their supervision, direction and control, payment of salary, workers' compensation, disability benefits, and like requirements and obligations. **LPISD** agrees that HCDE has no responsibility for any conduct of **LPISD** or **LPISD's** employees, agents, representatives, contractors, or subcontractors.

- 19. **Authority.** Each Party acknowledges, represents, and warrants that it has the power and authority to enter into this Contract and to perform its obligations hereunder, without the need for any consents or approvals not yet obtained, except to the extent that this Contract requires approval of either Party's Board of Trustees.
- 20. **Force Majeure.** Neither HCDE nor LPISD shall be deemed to have breached any provision of this Contract as a result of any delay, failure in performance, or interruption of service resulting directly or indirectly from acts of God, network failures, acts of civil or military authorities, civil disturbances, wars, energy crises, fires, transportation contingencies, interruptions in third-party telecommunications or Internet equipment or service, other catastrophes, or any other occurrences which are reasonably beyond such party's control.
- 21. **Severability.** In the event that any one or more of the terms or provisions contained in this Contract shall for any reason be held to be invalid, illegal, or unenforceable in any respect, such invalidity, illegality, or unenforceability shall not affect any other provisions, and the Contract shall be construed as if such invalid, illegal, or unenforceable provision had never been contained in it. The failure of a Party to enforce any provision of this Contract or to require performance by other party will not be deemed a waiver, or in any way affect the right of either party to enforce such provision thereafter.
- 22. **Contract Interpretation.** The Parties agree that the normal rules of construction that require that any ambiguities in this Contract are to be construed against the drafter shall not be employed in the interpretation of this Contract.
- 23. **Captions.** The captions herein are for convenience and identification purposes only, and not an integral part hereof, and are not to be considered in the interpretation of any part hereof.
- 24. **Entire Agreement.** This Contract contains and embraces the entire agreement between the parties, and neither it, nor any part of it may be changed, altered, modified, limited or extended, orally or by any agreement between the parties, unless such agreement by expressed in writing, signed and acknowledged by HCDE and LPISD's.

 <hr style="border: 0; border-top: 1px solid black; margin: 5px 0;"/> District School Superintendent/Designee	6/24/2021 <hr style="border: 0; border-top: 1px solid black; margin: 5px 0;"/> Date
<hr style="border: 0; border-top: 1px solid black; margin: 5px 0;"/> Harris County School Superintendent/Designee	<hr style="border: 0; border-top: 1px solid black; margin: 5px 0;"/> Date

For HCDE Office use only: Revenue Account No. 19920060100131 57250000 ABS East

**INTERLOCAL AGREEMENT FOR SPECIALIZED SERVICES  
ACADEMIC BEHAVIOR SCHOOL (ABS) EAST**

**2021-2022 ANNUAL CONTRACT**

Pursuant to the Interlocal Cooperation Act, Chapter 791 of the Texas Government Code, Harris County Department of Education ("HCDE") and the **Spring ISD Independent School District**, ("SISD") hereby enter into an Interlocal Contract ("Contract") for the purpose of providing educational and related services for eligible student(s) with disabilities of the SISD and to state the terms, rights and duties of the contracting parties.

1. **Term.** This Contract is for the term of **August 23, 2021** through **June 3, 2022**. During said term, HCDE agrees to provide services described herein for **twelve (12) total: Adaptive Behavior Program/LIFE Skills Program** unit(s) to eligible student(s) with disabilities ("Student(s)") who are residents of the SISD.
2. **HCDE Responsibilities.**
  - a) HCDE agrees to provide specialized facilities and certified/licensed personnel necessary to provide educational, instructional, and counseling services to the student(s) placed at ABS East in accordance with applicable law and during the days and times set forth by ABS East. HCDE may perform the services contracted for herein by using its own employees or independent contractors. HCDE will use its best efforts to provide the necessary specialized facilities and properly certified/licensed personnel in accordance with applicable law.
  - b) HCDE agrees to furnish the SISD with a monthly statement of student(s) attendance. HCDE agrees to furnish SISD with documentation of restraints within two (2) HCDE school days. HCDE will provide documentation of restraint procedures upon request by SISD.
  - c) HCDE may provide transportation for the student(s) to and from field trips, vocational training, and similar activities, if written permission allowing HCDE to transport students is provided by the students' parents/guardians.
  - d) HCDE agrees to maintain necessary records and accounts in order to assure that funds received from the SISD have been expended for the services described herein. HCDE agrees to provide these records and other information as may be required by the SISD.
3. **SISD's Responsibilities.**
  - a) SISD is responsible for providing transportation for the student(s) to and from ABS East. Location of pick-up and drop-off points and time of service will be mutually determined by representatives of SISD and HCDE.
  - b) SISD shall provide copies of all Student Records (as hereinafter defined) pertaining to the student(s) no later than five (5) HCDE business days prior to student(s)'s first day of attendance at ABS East. SISD agrees to furnish HCDE a copy of any additional pertinent documents regarding the student(s) that may be requested from or obtained by SISD during the term of this Contract. SISD shall provide copies of additional records, including SISD Records, as reasonably requested by HCDE.
  - c) SISD retains the responsibility to report SISD student(s)'s average daily attendance and other required information through the Public Education Information Management System ("PEIMS").
4. **Student Records; Confidentiality.**

For purposes of this Contract, "Student Records" shall be defined as student information including personal identifiers such as name, address, phone number, date of birth, Social Security number, and student identification number, and any student information protected by law, including "personally identifiable information" and student "education records" as those terms are defined by the Family Educational Rights and Privacy Act, 20 USC 1232g, as amended ("FERPA"); "personal information" as that term is defined in the Children's Online Privacy Protection Act of 1998 ("COPPA"); "personal information" as that term is defined in the Protection of Pupil Rights Amendment ("PPRA"); "personally identifiable information" as that term is defined in the Individuals with Disabilities Education Act, as amended ("IDEA"); "protected health information" as that term is defined in the Health Insurance Portability and Accountability Act of 1996 ("HIPAA"); and "personal identifying information" ~~269~~

“sensitive personal information” as defined under the Texas Identity Theft Enforcement and Protection Act (Chapter 521, Texas Business and Commerce Code).

Notwithstanding any contrary provision of this Contract, both Parties and their employees, agents, and subcontractors may access and use Student Records only as permitted by law for the purpose(s) for which the disclosure was made. Both Parties agree to abide by FERPA’s limitations and requirements imposed on school officials, including, but not limited to, the requirements of 34 C.F.R. 99.33(a). HCDE and SISD expressly agree that: (1) the services/functions to be provided by HCDE are services/functions for which SISD would otherwise use its own employees; (2) both Parties have been determined to meet the criteria set forth in SISD’s annual notification of FERPA rights for being school officials with legitimate educational interests in the Student Records; (3) SISD is under HCDE’s direct control with respect to SISD’s access to, use of, and disclosure of Student Records as gathered and maintained by HCDE; (4) HCDE is under SISD’s direct control with respect to HCDE’s access to, use of, and disclosure of Student Records as gathered and maintained by HCDE; and (5) both Parties will use Student Records only for authorized purposes and will not re-disclose Student Records to other parties, unless each Party has specific authorization from the other Party to do so or the disclosure is otherwise permitted by applicable law, including without limitation, FERPA, HIPAA, COPPA, IDEA, PPRA and the Texas Identity Theft Enforcement and Protection Act.

**5. Immunity.**

Nothing in this Contract shall be construed as a waiver or relinquishment of any governmental immunities or defenses on behalf of either Party or their respective trustees, officers, employees, and agents as a result of the execution of this Contract or performance of the functions or obligations described herein.

**6. Collaboration.** Both Parties agree to collaborate, as necessary, to administer the services described in this Contract and to act in the best interest of the student(s). Both Parties shall use collaborative problem-solving techniques and best efforts to resolve issues between the Parties as they may arise.

**7. Special Education Services.**

- a) Special education student(s) served under this Contract have been placed by the Admission, Review and Dismissal (ARD) Committee of the student(s)’s school of regular attendance within SISD and recommended for services as described herein. The ARD Committee of SISD has affirmed the classification and approved the recommendation of such contracted services.
- b) HCDE will be available for participation with the SISD ARD Committee in the development of the Individualized Education Plan (IEP). HCDE will update the SISD on the implementation of the IEP at least once per semester. A member of the SISD special education personnel will monitor, assess and evaluate the student(s)’s progress as established by the IEP, including at least one on-site visit annually.
- c) HCDE will follow the IDEA and other applicable laws when considering dismissal and/or expulsion of a qualified special education student(s) from ABS East.
- d) SISD agrees to invite an HCDE representative as a non-consensus member to any SISD ARD Committee meeting for SISD student(s) placed at ABS East pursuant to this Contract.
- e) HCDE will not use prohibited aversive techniques, as that term is defined by Texas Education Code § 37.0023.

**8. Local Education Agency.**

Student(s) receiving services from HCDE pursuant to this Contract remain enrolled in SISD and are considered students of SISD for all purposes. ISD remains the Local Education Agency (“LEA”), as that term is defined by the IDEA, and the “Recipient” as that term is defined by Section 504 of the Rehabilitation Act of 1973 (“Section 504”), and solely retains the obligation to provide and to ensure that

any eligible **SISD** student is provided a free appropriate public education ("FAPE") while receiving services from HCDE. **SISD** retains all responsibilities required of the LEA pursuant to the IDEA, and required of the Recipient pursuant to Section 504, including, but not limited to, requirements regarding identification, evaluation, educational placement, the provision of FAPE, and procedural safeguards. For any dispute, including a special education complaint or due process hearing, arising under the IDEA, Section 504, or other applicable law regarding an **SISD** student placed at HCDE, **SISD** recognizes and acknowledges that HCDE is not the LEA or Recipient for the **SISD** student and is in no way liable to the student, parent, or **SISD** under the IDEA, Section 504, or other applicable law.

9. **Invoices and Payment.** In consideration of the services provided herein, **SISD** agrees to pay HCDE a total amount of **\$247,260**. Total amount is calculated by multiplying the number of units times the annual **in-county** tuition rate (**\$20,605**).

HCDE will invoice **SISD** and payment will be due immediately upon receipt of invoice. **SISD** agrees to pay HCDE in the following manner:

- 50% of annual total amount due will be invoiced in **September 2021**
- 50% of annual total amount due will be invoiced in **January 2022**

If applicable, in consideration of Extended School Year Services (ESY) provided, **SISD** agrees to pay HCDE in the following manner:

- \$5,278 in-county tuition rate times number of ESY students enrolled.
  - 100% of ESY total amount due will be invoiced in **July 2022**.
- a) In the event that **SISD** makes a payment to HCDE with a credit card, **SISD** agrees to pay to HCDE a surcharge fee consisting of any applicable credit card fees and costs borne by HCDE, including, without limitation, the processing fee(s) charged to HCDE by the credit card company(ies).
  - b) **SISD** may sell unused units to another district upon obtaining HCDE's prior written consent.
  - c) Each Party paying for the performance of governmental functions and/or invoices must make those payments from current revenues available to the paying Party.
  - d) The source of funding for this contract will be from **SISD federal** (federal, state or local) funds. The parents of the student(s) shall not be charged for the services contracted under this Contract.

10. **SISD Liaison.** **SISD** shall appoint a qualified liaison to communicate on behalf of **SISD** with HCDE representatives. The liaison shall be knowledgeable in no less than the student(s)'s educational and disciplinary records; ABS East programs, policies, and procedures; and special education law, policies, and procedure, if appropriate. The **SISD** liaison shall make best efforts to assist ABS East representatives in providing services to students, including, but not limited to, acquiring information regarding the student(s), assessing best placement, and communicating with **SISD** employees and student(s)'s parents/guardians, as necessary.

11. **Termination.**

- a) HCDE shall have the right to terminate this Contract for convenience, effective at the end of the Term, or with at least thirty (30) calendar days prior written notice to **SISD** . If HCDE exercises such termination right, HCDE shall have no obligation to refund to **SISD** the amount of any pre-paid fees for any period following the effective date of such termination.
- b) Both Parties may terminate this Contract with or without cause by mutual written agreement.
- c) Upon the effective date of termination or expiration of this Contract, except as otherwise explicitly stated herein, the Parties shall have no obligations to the other Party under this Contract. Student(s) in attendance at ABS East at the time of termination or expiration of this Contract will return to **SISD** . All Student Records maintained by HCDE during the duration of providing services to the student will be provided to **SISD** within ten (10) business days following the date of termination or expiration, at the written request of **SISD** .

12. **Equal Opportunity.** It is the policy of HCDE not to discriminate on the basis of race, color, national origin, gender, limited English proficiency or handicapping conditions in its programs. SISD agrees not to discriminate against any employee, student(s), or other person or party in the performance of this Contract, with respect to placement at ABS East, services to be provided, conditions and privileges of employment, or a matter directly or indirectly related to age (except where based on a bona fide occupational qualification), sex (except where based on a bona fide occupational qualification), race, color, religion, national origin, or ancestry. Breach of this covenant may be regarded as a material breach of this Contract.
13. **Assignment.** Neither this Contract nor any duties or obligations under it shall be assignable by either Party without the prior written acknowledgment and authorization of the other Party.
14. **Notice.** Any notice provided under the terms of this Contract by either Party to the other shall be in writing and shall be deemed sufficient forty-eight (48) hours after being deposited in the regular mail as certified mail, return receipt requested, if such notice is addressed to the party to be notified at such Party's address as set forth below:

**HCDE**

Attention: James Colbert, Jr., County School Superintendent  
6300 Irvington Boulevard  
Houston, Texas 77022-5618

**SISD**

Attention: Dr. Rodney E. Watson, Superintendent  
16717 Ella Blvd.  
Houston, Texas 77090

Each Party may change the address at which notice may be sent to that Party by giving notice of such change to the other Party in accordance with the provisions of this Article.

15. **Third Party Beneficiaries.** Nothing in this Contract shall be deemed or construed to create any third-party beneficiaries or otherwise give any third party any claim or right of action against any party to this Contract.
16. **Choice of Law and Venue.** This Contract shall be construed under the laws of the State of Texas, and mandatory and exclusive venue for any action arising out of this Contract shall be in Harris County, Texas.
17. **Amendments and Waivers.** Any term of this Contract may be amended or waived only with the written consent of the Parties or their respective permitted successors and assigns. Any amendment or waiver effected in accordance with this Article shall be binding upon the Parties and their respective successors and assigns.
18. **Separate Entities.** There is no relationship of agency, partnership, joint venture, employment, or franchise between the Parties. Neither Party has the authority to bind the other or to incur any obligation on its behalf. SISD assumes full responsibility for the actions of its personnel while performing any services incident to this Contract, including, but not limited to, transportation and special education services, and shall remain solely responsible for their supervision, direction and control, payment of salary, workers' compensation, disability benefits, and like requirements and obligations. SISD agrees that HCDE has no responsibility for any conduct of SISD or SISD's employees, agents, representatives, contractors, or subcontractors.
19. **Authority.** Each Party acknowledges, represents, and warrants that it has the power and authority to enter into this Contract and to perform its obligations hereunder, without the need for any consents or approvals



not yet obtained, except to the extent that this Contract requires approval of either Party's Board of Trustees.

20. **Force Majeure.** Neither HCDE nor SISD shall be deemed to have breached any provision of this Contract as a result of any delay, failure in performance, or interruption of service resulting directly or indirectly from acts of God, network failures, acts of civil or military authorities, civil disturbances, wars, energy crises, fires, transportation contingencies, interruptions in third-party telecommunications or Internet equipment or service, other catastrophes, or any other occurrences which are reasonably beyond such party's control.
21. **Severability.** In the event that any one or more of the terms or provisions contained in this Contract shall for any reason be held to be invalid, illegal, or unenforceable in any respect, such invalidity, illegality, or unenforceability shall not affect any other provisions, and the Contract shall be construed as if such invalid, illegal, or unenforceable provision had never been contained in it. The failure of a Party to enforce any provision of this Contract or to require performance by other party will not be deemed a waiver, or in any way affect the right of either party to enforce such provision thereafter.
22. **Contract Interpretation.** The Parties agree that the normal rules of construction that require that any ambiguities in this Contract are to be construed against the drafter shall not be employed in the interpretation of this Contract.
23. **Captions.** The captions herein are for convenience and identification purposes only, and not an integral part hereof, and are not to be considered in the interpretation of any part hereof.
24. **Entire Agreement.** This Contract contains and embraces the entire agreement between the parties, and neither it, nor any part of it may be changed, altered, modified, limited or extended, orally or by any agreement between the parties, unless such agreement by expressed in writing, signed and acknowledged by HCDE and SISD .

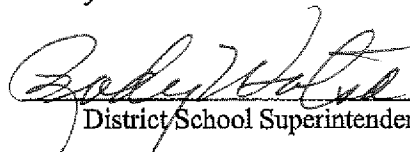
 _____ District School Superintendent/Designee	Rodney E. Watson, Ph.D. Superintendent of Schools	6/14/21 _____ Date
---	--	--------------------------

_____ Harris County School Superintendent/Designee	_____ Date
---	---------------

For HCDE Office use only: Revenue Account No. 19900060200132 57250000 ABS East

**Regular Board Meeting**

**8.D.4.**

**Meeting Date:** July 21, 2021  
**Title:** Schools Division Highpoint School East Annual Contracts FY21: Deer Park (9); Galena Park (5); La Porte (6); Spring Branch ISD (8)

**Submitted For:** Charles Ned, Schools  
**Submitted By:** Denise Alamos  
**Recommended Action:** Approve  
**HCDE Goal(s):** 1. Impact education/respond to evolving needs  
2. Deliver value responsibly  
5. Recruit high-quality professionals

**Additional Resource Personnel:**  
**Facilities/Technology Approval Needed?:** None

**Information**

**Posted Agenda Item:**

**Approval of Interlocal (revenue) contracts for FY 2022 in the aggregate amount of \$281,372 with Highpoint School East with the following districts:** Deer Park ISD for nine (9) in-county annual contracts in the amount of \$90,441 (\$10,049 each); Galena Park ISD for five (5) in-county annual contracts in the amount of \$50,245 (\$10,049 each); La Porte ISD for six (6) in-county annual contracts in the amount of \$60,294 (\$10,049 each); and Spring Branch ISD for eight (8) in-county annual contracts in the amount of \$80,392 (\$10,049 each) for the contract period of 08/23/2021 through 06/03/2022.

**Subject:**

**Approval of Interlocal (revenue) contracts for FY 2022 in the aggregate amount of \$281,372 with Highpoint School East with the following districts:** Deer Park ISD for nine (9) in-county annual contracts in the amount of \$90,441 (\$10,049 each); Galena Park ISD for five (5) in-county annual contracts in the amount of \$50,245 (\$10,049 each); La Porte ISD for six (6) in-county annual contracts in the amount of \$60,294 (\$10,049 each); and Spring Branch ISD for eight (8) in-county annual contracts in the amount of \$80,392 (\$10,049 each) for the contract period of 08/23/2021 through 06/03/2022.

**Rationale:**

Entity	Description	Dates	Totals
Deer Park ISD	Annual Contract (9) In-County \$10,049 each	8/23/2021-06/03/2022	\$90,441
Galena Park ISD	Annual Contract (5) In-County \$10,049 each	8/23/2021-06/06/2022	\$50,245
La Porte ISD	Annual Contract (6) In-County \$10,049 each	8/23/2021-06/06/2022	\$60,294
Spring Branch ISD	Annual Contract (8) In-County \$10,049 each	8/23/2021-06/06/2022	\$80,392
<b>Total</b>			<b>\$281,372</b>

**Fiscal Impact**

**Included in FY budget Y/N:** Y  
**Included in current budget amendment Y/N:** N

**Attachments**

FY22 HSE-Galena Park ISD-5 \$50,245  
FY22 HSE-La Porte ISD-6\_\$60,294  
FY22 HSE-Spring Branch ISD-8 \$80,392

---

### Form Review

**Inbox**

Purchasing  
Assistant Superintendent - Business  
Denise Alamos (Originator)  
Purchasing  
Assistant Superintendent - Business  
Form Started By: Denise Alamos  
Final Approval Date: 07/09/2021

**Reviewed By**

Kendra Jackson  
Jesus Amezcua  
Denise Alamos  
Kendra Jackson  
Jesus Amezcua

**Date**

06/04/2021 01:24 PM  
06/21/2021 04:03 PM  
06/28/2021 02:10 PM  
07/06/2021 12:42 PM  
07/09/2021 03:54 PM  
Started On: 06/01/2021 10:49 AM

**INTERLOCAL AGREEMENT FOR SPECIALIZED SERVICES  
HIGHPOINT SCHOOL (HS) EAST**

**2021 – 2022 ANNUAL CONTRACT**

Pursuant to the Interlocal Cooperation Act, Chapter 791 of the Texas Government Code, Harris County Department of Education (“HCDE”) and **Deer Park ISD, (“DPISD”)** hereby enter into an Interlocal Contract (“Contract”) for the purpose of providing educational and related services under the Texas Education Code (TEC), Chapter 37, for students who have been removed from **DPISD** for committing an offense described in TEC, Chapter 37, or for engaging in behavior(s) for which **DPISD** Student Code of Conduct requires a discipline alternative education placement.

1. **Term.** This Contract is for the term of **August 23, 2021** through **June 3, 2022**. During said term, HCDE agrees to provide services described herein for **nine (9)** units to eligible student(s) requiring a discipline alternative education placement (referred to herein as “student(s)”) who are residents of **DPISD**.
2. **HCDE Responsibilities.**
  - a) HCDE agrees to provide specialized facilities and certified/licensed personnel necessary to provide educational, instructional, and counseling services to the student(s) placed at Highpoint in accordance with applicable law and during the days and times set forth by Highpoint. HCDE may perform the services contracted for herein by using its own employees or independent contractors. HCDE will not be held responsible for the services contracted herein if the necessary specialized facilities and properly certified/licensed personnel are unavailable.
  - b) HCDE agrees to furnish the **DPISD** with a weekly statement of student(s) attendance.
  - c) HCDE may provide transportation for the student(s) to and from field trips, vocational training, and similar activities, if written permission allowing HCDE to transport students is provided by the students’ parents/guardians.
  - d) HCDE agrees to maintain necessary records and accounts in order to assure that funds received from the **DPISD** have been expended for the services described herein. HCDE agrees to provide these records and other information as may be required by the **DPISD**.
3. **DPISD’s Responsibilities.**
  - a) **DPISD** is responsible for providing transportation for the student(s) to and from Highpoint. Location of pick-up and drop-off points and time of service will be mutually determined by representatives of **DPISD** and HCDE.
  - b) **DPISD** shall provide copies of all Student Records (as hereinafter defined) pertaining to the student(s) no later than five (5) HCDE business days prior to student(s)’s first day of attendance at Highpoint. **DPISD** agrees to furnish HCDE a copy of any additional pertinent documents regarding the student(s) that may be requested from or obtained by **DPISD** during the term of this Contract. Student Records to be provided by **DPISD** include, but are not limited to, the following: (a) a recommendation letter from the student(s)’s campus or **DPISD** stating explicitly why the student is being referred to Highpoint; (b) the student’s Middle School Plan (for students in grades 6-8) or the student’s Graduation Plan (for students in grades 9-12); (c) the student’s current transcript, including all achievement test records; (d) for special education students, the student’s current IEP, in accordance with Article 7 this Contract; (e) withdrawal form, which shall indicate the list of current courses in which the student is enrolled, the grade earned and the textbook and other instructional resources being used with that subject; and (f) the student’s

current year's attendance records. **DPISD** shall provide copies of additional records, including **DPISD** Records, as reasonably requested by HCDE.

- c) **DPISD** retains the responsibility to report **DPISD** student(s)'s average daily attendance and other required information through the Public Education Information Management System ("PEIMS").
- 4. Student Records; Confidentiality.** For purposes of this Contract, "Student Records" shall be defined as student information including personal identifiers such as name, address, phone number, date of birth, Social Security number, and student identification number, and any student information protected by law, including "personally identifiable information" and student "education records" as those terms are defined by the Family Educational Rights and Privacy Act, 20 USC 1232g, as amended ("FERPA"); "personal information" as that term is defined in the Children's Online Privacy Protection Act of 1998 ("COPPA"); "personal information" as that term is defined in the Protection of Pupil Rights Amendment ("PPRA"); "personally identifiable information" as that term is defined in the Individuals with Disabilities Education Act, as amended ("IDEA"); "protected health information" as that term is defined in the Health Insurance Portability and Accountability Act of 1996 ("HIPAA"); and "personal identifying information" and "sensitive personal information" as defined under the Texas Identity Theft Enforcement and Protection Act (Chapter 521, Texas Business and Commerce Code).

Notwithstanding any contrary provision of this Contract, both Parties and their employees, agents, and subcontractors may access and use Student Records only as permitted by law for the purpose(s) for which the disclosure was made. Both Parties agree to abide by FERPA's limitations and requirements imposed on school officials, including, but not limited to, the requirements of 34 C.F.R. 99.33(a). HCDE and **DPISD** expressly agree that: (1) the services/functions to be provided by HCDE are services/functions for which **DPISD** would otherwise use its own employees; (2) both Parties have been determined to meet the criteria set forth in **DPISD**'s annual notification of FERPA rights for being school officials with legitimate educational interests in the Student Records; (3) **DPISD** is under HCDE's direct control with respect to **DPISD**'s access to, use of, and disclosure of Student Records as gathered and maintained by HCDE; (4) HCDE is under **DPISD**'s direct control with respect to HCDE's access to, use of, and disclosure of Student Records as gathered and maintained by HCDE; and (5) both Parties will use Student Records only for authorized purposes and will not re-disclose Student Records to other parties, unless each Party has specific authorization from the other Party to do so or the disclosure is otherwise permitted by applicable law, including without limitation, FERPA, HIPAA, COPPA, IDEA, PPRA and the Texas Identity Theft Enforcement and Protection Act.

- 5. Immunity.** Nothing in this Contract shall be construed as a waiver or relinquishment of any governmental immunities or defenses on behalf of either Party or their respective trustees, officers, employees, and agents as a result of the execution of this Contract or performance of the functions or obligations described herein.
- 6. Collaboration.** Both Parties agree to collaborate, as necessary, to administer the services described in this Contract and to act in the best interest of the student(s). Both Parties shall use collaborative problem-solving techniques and best efforts to resolve issues between the Parties as they may arise.
- 7. Special Education Services.**
  - a) Special education student(s) served under this Contract have been placed by the Admission, Review and Dismissal (ARD) Committee of the student(s)'s school of regular attendance within **DPISD** and recommended for services as described herein. The ARD Committee of **DPISD** has affirmed the classification and approved the recommendation of such contracted services. An HCDE representative must participate in the ARD Committee meeting considering the special education student(s)'s placement, and HCDE must confirm in writing the student's eligibility for the program prior to the ARD Committee's consideration of placement at Highpoint.

- b) HCDE is responsible for providing educational and support services to special education student(s) in the same manner those services are provided to non-disabled students. Any and all additional services and funding required to implement the student's Individualized Education Program (IEP) and/or 504 plan are to be provided by **DPISD**. **DPISD** may make such services available in conjunction with Highpoint or at a separate time and location, at the discretion of **DPISD** and the ARD Committee, with HCDE participation. If **DPISD** chooses to make such services available in conjunction with Highpoint, **DPISD** will cooperate with Highpoint to minimize disruption at Highpoint. If **DPISD** requires the student(s) to leave Highpoint during the school day, the IEP must include transportation as a related service.
  - c) HCDE will follow the IDEA and other applicable laws when considering dismissal and/or expulsion of a qualified special education student(s) from Highpoint.
  - d) **DPISD** agrees to invite an HCDE representative as a non-consensus member to any **DPISD** ARD Committee meeting for **DPISD** student(s) placed at Highpoint pursuant to this Contract.
8. **Local Education Agency.** Student(s) receiving services from HCDE pursuant to this Contract remain enrolled in **DPISD** and are considered students of **DPISD** for all purposes. ISD remains the Local Education Agency ("LEA"), as that term is defined by the IDEA, and the "Recipient" as that term is defined by Section 504 of the Rehabilitation Act of 1973 ("Section 504"), and solely retains the obligation to provide and to ensure that any eligible **DPISD** student is provided a free appropriate public education ("FAPE") while receiving services from HCDE. **DPISD** retains all responsibilities required of the LEA pursuant to the IDEA, and required of the Recipient pursuant to Section 504, including, but not limited to, requirements regarding identification, evaluation, educational placement, the provision of FAPE, and procedural safeguards. For any dispute, including a special education complaint or due process hearing, arising under the IDEA, Section 504, or other applicable law regarding an **DPISD** student placed at HCDE, **DPISD** recognizes and acknowledges that HCDE is not the LEA or Recipient for the **DPISD** student and is in no way liable to the student, parent, or **DPISD** under the IDEA, Section 504, or other applicable law.
9. **Monitoring Student Progress.** HCDE will update **DPISD** on the progress of the referred student(s) at least once per semester, in a manner determined to be appropriate by HCDE, including, but not limited to, a grade report, summary of any formal disciplinary action, and summary of attendance. A member of the **DPISD** administrative staff will monitor, assess, and evaluate student's progress as established by this Contract, including at least one (1) on-site visit annually.
10. **Invoices and Payment.** In consideration of the services provided herein, **DPISD** agrees to pay HCDE an in-county fee of **\$90,441** and any additional fees in the following manner:
- i. **\$10,049** times the number of units purchased. **DPISD** will be billed twice a year and payment will be due upon receipt of invoice.
  - ii. **\$75.00** special education surcharge times the number of enrollment days for Special Education student(s).
  - iii. **\$115.00** per diem times the number of student(s) in attendance over the number of units purchased (9).
- a) HCDE will bill **DPISD** for the amount of units purchased. Payment will be due within 30 days of the date of **DPISD**'s receipt of invoice. Payment obligations are non-cancelable, and fees paid are non-refundable. **DPISD** may sell unused units to another independent school district upon obtaining HCDE's prior written consent.
  - b) In the event that **DPISD** makes a payment to HCDE with a credit card, **DPISD** agrees to pay to HCDE a surcharge fee consisting of any applicable credit card fees and costs borne by HCDE,

including, without limitation, the processing fee(s) charged to HCDE by the credit card company(ies).

- c) HCDE agrees to maintain records and accounts to the extent necessary to assure that funds received from **DPISD** have been expended for the services described herein. HCDE agrees to provide these records and other information as may be requested and required by **DPISD**.
- d) Each Party paying for the performance of governmental functions and/or invoices must make those payments from current revenues available to the paying Party.

**11. Payment by Student(s) and Parents.** The parents of the student(s) placed at Highpoint shall not be charged for the services contracted under this Contract. Services needed by the student, if any, beyond the scope of the Contract shall be the responsibility of the student(s) and/or his/her parent or guardian.

**12. DPISD Liaison.** **DPISD** shall appoint a qualified liaison to communicate on behalf of **DPISD** with HCDE representatives. The liaison shall be knowledgeable in no less than the student(s)'s educational and disciplinary records; Highpoint School East programs, policies, and procedures; and special education law, policies, and procedure, if appropriate. The **DPISD** liaison shall make best efforts to assist Highpoint School East representatives in providing services to students, including, but not limited to, acquiring information regarding the student(s), assessing best placement, and communicating with **DPISD** employees and student(s)'s parents/guardians, as necessary.

**13. Termination.**

- a) HCDE shall have the right to terminate this Contract for convenience, effective at the end of the Term, or with at least thirty (30) calendar days prior written notice to **DPISD**. If HCDE exercises such termination right, HCDE shall have no obligation to refund to **DPISD** the amount of any pre-paid fees for any period following the effective date of such termination.
- b) Both Parties may terminate this Contract with or without cause by mutual written agreement.
- c) Upon the effective date of termination or expiration of this Contract, except as otherwise explicitly stated herein, the Parties shall have no obligations to the other Party under this Contract. Student(s) in attendance at Highpoint School East at the time of termination or expiration of this Contract will return to **DPISD**. All Student Records maintained by HCDE during the duration of providing services to the student will be provided to **DPISD** within ten (10) business days following the date of termination or expiration, at the written request of **DPISD**.

**14. Equal Opportunity.** It is the policy of HCDE not to discriminate on the basis of race, color, national origin, gender, limited English proficiency or handicapping conditions in its programs. **DPISD** agrees not to discriminate against any employee, student(s), or other person or party in the performance of this Contract, with respect to placement at Highpoint School East, services to be provided, conditions and privileges of employment, or a matter directly or indirectly related to age (except where based on a bona fide occupational qualification), sex (except where based on a bona fide occupational qualification), race, color, religion, national origin, or ancestry. Breach of this covenant may be regarded as a material breach of this Contract.

**15. Assignment.** Neither this Contract nor any duties or obligations under it shall be assignable by either Party without the prior written acknowledgment and authorization of the other Party.

**16. Notice.** Any notice provided under the terms of this Contract by either Party to the other shall be in writing and shall be deemed sufficient forty-eight (48) hours after being deposited in the regular mail as certified mail, return receipt requested, if such notice is addressed to the party to be notified at such Party's address as set forth below:

HCDE  
Attention: James Colbert, Jr., County School Superintendent  
6300 Irvington Boulevard  
Houston, Texas 77022-5618

**DPISD**  
Attention: Stephen Harrell, Superintendent  
2800 Texas Avenue  
Deer Park, Texas 77536

Each Party may change the address at which notice may be sent to that Party by giving notice of such change to the other Party in accordance with the provisions of this Article.

17. **Third Party Beneficiaries.** Nothing in this Contract shall be deemed or construed to create any third-party beneficiaries or otherwise give any third party any claim or right of action against any party to this Contract.
18. **Choice of Law and Venue.** This Contract shall be construed under the laws of the State of Texas, and mandatory and exclusive venue for any action arising out of this Contract shall be in Harris County, Texas.
19. **Amendments and Waivers.** Any term of this Contract may be amended or waived only with the written consent of the Parties or their respective permitted successors and assigns. Any amendment or waiver effected in accordance with this Article shall be binding upon the Parties and their respective successors and assigns.
20. **Separate Entities.** There is no relationship of agency, partnership, joint venture, employment, or franchise between the Parties. Neither Party has the authority to bind the other or to incur any obligation on its behalf. **DPISD** assumes full responsibility for the actions of its personnel while performing any services incident to this Contract, including, but not limited to, transportation and special education services, and shall remain solely responsible for their supervision, direction and control, payment of salary, workers' compensation, disability benefits, and like requirements and obligations. **DPISD** agrees that HCDE has no responsibility for any conduct of **DPISD** or **DPISD's** employees, agents, representatives, contractors, or subcontractors.
21. **Authority.** Each Party acknowledges, represents, and warrants that it has the power and authority to enter into this Contract and to perform its obligations hereunder, without the need for any consents or approvals not yet obtained, except to the extent that this Contract requires approval of either Party's Board of Trustees.
22. **Force Majeure.** Neither HCDE nor **DPISD** shall be deemed to have breached any provision of this Contract as a result of any delay, failure in performance, or interruption of service resulting directly or indirectly from acts of God, network failures, acts of civil or military authorities, civil disturbances, wars, energy crises, fires, transportation contingencies, interruptions in third-party telecommunications or Internet equipment or service, other catastrophes, or any other occurrences which are reasonably beyond such party's control.
23. **Severability.** In the event that any one or more of the terms or provisions contained in this Contract shall for any reason be held to be invalid, illegal, or unenforceable in any respect, such invalidity, illegality, or unenforceability shall not affect any other provisions, and the Contract shall be construed as if such invalid, illegal, or unenforceable provision had never been contained in it. The failure of a



Party to enforce any provision of this Contract or to require performance by other party will not be deemed a waiver, or in any way affect the right of either party to enforce such provision thereafter.

- 24. Contract Interpretation.** The Parties agree that the normal rules of construction that require that any ambiguities in this Contract are to be construed against the drafter shall not be employed in the interpretation of this Contract.
- 25. Captions.** The captions herein are for convenience and identification purposes only, and not an integral part hereof, and are not to be considered in the interpretation of any part hereof.
- 26. Entire Agreement.** This Contract contains and embraces the entire agreement between the parties, and neither it, nor any part of it may be changed, altered, modified, limited or extended, orally or by any agreement between the parties, unless such agreement by expressed in writing, signed and acknowledged by HCDE and **DPISD**.

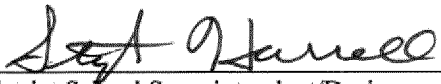
  
\_\_\_\_\_  
District School Superintendent/Designee

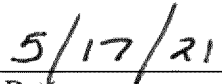
  
\_\_\_\_\_  
Date

\_\_\_\_\_  
County School Superintendent/Designee

\_\_\_\_\_  
Date

For HCDE Office use only: Revenue Account No. 19910060700970 57250000 **Highpoint School East**



**INTERLOCAL AGREEMENT FOR SPECIALIZED SERVICES  
HIGHPOINT SCHOOL (HS) EAST**

**2021-2022 ANNUAL CONTRACT**

Pursuant to the Interlocal Cooperation Act, Chapter 791 of the Texas Government Code, Harris County Department of Education (“HCDE”) and **Galena Park ISD, (“GPISD”)** hereby enter into an Interlocal Contract (“Contract”) for the purpose of providing educational and related services under the Texas Education Code (TEC), Chapter 37, for students who have been removed from **GPISD** for committing an offense described in TEC, Chapter 37, or for engaging in behavior(s) for which **GPISD** Student Code of Conduct requires a discipline alternative education placement.

1. **Term.** This Contract is for the term of **August 23, 2021** through **June 3, 2022**. During said term, HCDE agrees to provide services described herein for **five (5)** units to eligible student(s) requiring a discipline alternative education placement (referred to herein as “student(s)”) who are residents of **GPISD**.
2. **HCDE Responsibilities.**
  - a) HCDE agrees to provide specialized facilities and certified/licensed personnel necessary to provide educational, instructional, and counseling services to the student(s) placed at Highpoint in accordance with applicable law and during the days and times set forth by Highpoint. HCDE may perform the services contracted for herein by using its own employees or independent contractors. HCDE will not be held responsible for the services contracted herein if the necessary specialized facilities and properly certified/licensed personnel are unavailable.
  - b) HCDE agrees to furnish the **GPISD** with a weekly statement of student(s) attendance.
  - c) HCDE may provide transportation for the student(s) to and from field trips, vocational training, and similar activities, if written permission allowing HCDE to transport students is provided by the students’ parents/guardians.
  - d) HCDE agrees to maintain necessary records and accounts in order to assure that funds received from the **GPISD** have been expended for the services described herein. HCDE agrees to provide these records and other information as may be required by the **GPISD**.
3. **GPISD’s Responsibilities.**
  - a) **GPISD** is responsible for providing transportation for the student(s) to and from Highpoint. Location of pick-up and drop-off points and time of service will be mutually determined by representatives of **GPISD** and HCDE.
  - b) **GPISD** shall provide copies of all Student Records (as hereinafter defined) pertaining to the student(s) no later than five (5) HCDE business days prior to student(s)’s first day of attendance at Highpoint. **GPISD** agrees to furnish HCDE a copy of any additional pertinent documents regarding the student(s) that may be requested from or obtained by **GPISD** during the term of this Contract. Student Records to be provided by **GPISD** include, but are not limited to, the following: (a) a recommendation letter from the student(s)’s campus or **GPISD** stating explicitly why the student is being referred to Highpoint; (b) the student’s Middle School Plan (for students in grades 6-8) or the student’s Graduation Plan (for students in grades 9-12); (c) the student’s current transcript, including all achievement test records; (d) for special education students, the student’s current IEP, in accordance with Article 7 this Contract; (e) withdrawal form, which shall indicate the list of current courses in which the student is enrolled, the grade earned and the textbook and other instructional resources being used with that subject; and (f) the student’s

current year's attendance records. **GPISD** shall provide copies of additional records, including **GPISD** Records, as reasonably requested by HCDE.

- c) **GPISD** retains the responsibility to report **GPISD** student(s)'s average daily attendance and other required information through the Public Education Information Management System ("PEIMS").

4. **Student Records; Confidentiality.** For purposes of this Contract, "Student Records" shall be defined as student information including personal identifiers such as name, address, phone number, date of birth, Social Security number, and student identification number, and any student information protected by law, including "personally identifiable information" and student "education records" as those terms are defined by the Family Educational Rights and Privacy Act, 20 USC 1232g, as amended ("FERPA"); "personal information" as that term is defined in the Children's Online Privacy Protection Act of 1998 ("COPPA"); "personal information" as that term is defined in the Protection of Pupil Rights Amendment ("PPRA"); "personally identifiable information" as that term is defined in the Individuals with Disabilities Education Act, as amended ("IDEA"); "protected health information" as that term is defined in the Health Insurance Portability and Accountability Act of 1996 ("HIPAA"); and "personal identifying information" and "sensitive personal information" as defined under the Texas Identity Theft Enforcement and Protection Act (Chapter 521, Texas Business and Commerce Code).

Notwithstanding any contrary provision of this Contract, both Parties and their employees, agents, and subcontractors may access and use Student Records only as permitted by law for the purpose(s) for which the disclosure was made. Both Parties agree to abide by FERPA's limitations and requirements imposed on school officials, including, but not limited to, the requirements of 34 C.F.R. 99.33(a). HCDE and **GPISD** expressly agree that: (1) the services/functions to be provided by HCDE are services/functions for which **GPISD** would otherwise use its own employees; (2) both Parties have been determined to meet the criteria set forth in **GPISD**'s annual notification of FERPA rights for being school officials with legitimate educational interests in the Student Records; (3) **GPISD** is under HCDE's direct control with respect to **GPISD**'s access to, use of, and disclosure of Student Records as gathered and maintained by HCDE; (4) HCDE is under **GPISD**'s direct control with respect to HCDE's access to, use of, and disclosure of Student Records as gathered and maintained by HCDE; and (5) both Parties will use Student Records only for authorized purposes and will not re-disclose Student Records to other parties, unless each Party has specific authorization from the other Party to do so or the disclosure is otherwise permitted by applicable law, including without limitation, FERPA, HIPAA, COPPA, IDEA, PPRA and the Texas Identity Theft Enforcement and Protection Act.

5. **Immunity.** Nothing in this Contract shall be construed as a waiver or relinquishment of any governmental immunities or defenses on behalf of either Party or their respective trustees, officers, employees, and agents as a result of the execution of this Contract or performance of the functions or obligations described herein.
6. **Collaboration.** Both Parties agree to collaborate, as necessary, to administer the services described in this Contract and to act in the best interest of the student(s). Both Parties shall use collaborative problem-solving techniques and best efforts to resolve issues between the Parties as they may arise.
7. **Special Education Services.**
- a) Special education student(s) served under this Contract have been placed by the Admission, Review and Dismissal (ARD) Committee of the student(s)'s school of regular attendance within **GPISD** and recommended for services as described herein. The ARD Committee of **GPISD** has affirmed the classification and approved the recommendation of such contracted services. An HCDE representative must participate in the ARD Committee meeting considering the special education student(s)'s placement, and HCDE must confirm in writing the student's eligibility for the program prior to the ARD Committee's consideration of placement at Highpoint.

- b) HCDE is responsible for providing educational and support services to special education student(s) in the same manner those services are provided to non-disabled students. Any and all additional services and funding required to implement the student's Individualized Education Program (IEP) and/or 504 plan are to be provided by **GPISD**. **GPISD** may make such services available in conjunction with Highpoint or at a separate time and location, at the discretion of **GPISD** and the ARD Committee, with HCDE participation. If **GPISD** chooses to make such services available in conjunction with Highpoint, **GPISD** will cooperate with Highpoint to minimize disruption at Highpoint. If **GPISD** requires the student(s) to leave Highpoint during the school day, the IEP must include transportation as a related service.
- c) HCDE will follow the IDEA and other applicable laws when considering dismissal and/or expulsion of a qualified special education student(s) from Highpoint.
- d) **GPISD** agrees to invite an HCDE representative as a non-consensus member to any **GPISD** ARD Committee meeting for **GPISD** student(s) placed at Highpoint pursuant to this Contract.
8. **Local Education Agency.** Student(s) receiving services from HCDE pursuant to this Contract remain enrolled in **GPISD** and are considered students of **GPISD** for all purposes. ISD remains the Local Education Agency ("LEA"), as that term is defined by the IDEA, and the "Recipient" as that term is defined by Section 504 of the Rehabilitation Act of 1973 ("Section 504"), and solely retains the obligation to provide and to ensure that any eligible **GPISD** student is provided a free appropriate public education ("FAPE") while receiving services from HCDE. **GPISD** retains all responsibilities required of the LEA pursuant to the IDEA, and required of the Recipient pursuant to Section 504, including, but not limited to, requirements regarding identification, evaluation, educational placement, the provision of FAPE, and procedural safeguards. For any dispute, including a special education complaint or due process hearing, arising under the IDEA, Section 504, or other applicable law regarding an **GPISD** student placed at HCDE, **GPISD** recognizes and acknowledges that HCDE is not the LEA or Recipient for the **GPISD** student and is in no way liable to the student, parent, or **GPISD** under the IDEA, Section 504, or other applicable law.
9. **Monitoring Student Progress.** HCDE will update **GPISD** on the progress of the referred student(s) at least once per semester, in a manner determined to be appropriate by HCDE, including, but not limited to, a grade report, summary of any formal disciplinary action, and summary of attendance. A member of the **GPISD** administrative staff will monitor, assess, and evaluate student's progress as established by this Contract, including at least one (1) on-site visit annually.
10. **Invoices and Payment.** In consideration of the services provided herein, **GPISD** agrees to pay HCDE an in-county fee of **\$50,245** and any additional fees in the following manner:
- i. **\$10,049** times the number of units purchased. **GPISD** will be billed twice a year and payment will be due upon receipt of invoice.
  - ii. **\$75.00** special education surcharge times the number of enrollment days for Special Education student(s).
  - iii. **\$115.00** per diem times the number of student(s) in attendance over the number of units purchased (5).
- a) HCDE will bill **GPISD** for the amount of units purchased. Payment will be due within 30 days of the date of **GPISD**'s receipt of invoice. Payment obligations are non-cancelable, and fees paid are non-refundable. **GPISD** may sell unused units to another independent school district upon obtaining HCDE's prior written consent.
- b) In the event that **GPISD** makes a payment to HCDE with a credit card, **GPISD** agrees to pay to HCDE a surcharge fee consisting of any applicable credit card fees and costs borne by HCDE,

including, without limitation, the processing fee(s) charged to HCDE by the credit card company(ies).

- c) HCDE agrees to maintain records and accounts to the extent necessary to assure that funds received from **GPISD** have been expended for the services described herein. HCDE agrees to provide these records and other information as may be requested and required by **GPISD**.
- d) Each Party paying for the performance of governmental functions and/or invoices must make those payments from current revenues available to the paying Party.

**11. Payment by Student(s) and Parents.** The parents of the student(s) placed at Highpoint shall not be charged for the services contracted under this Contract. Services needed by the student, if any, beyond the scope of the Contract shall be the responsibility of the student(s) and/or his/her parent or guardian.

**12. GPISD Liaison.** **GPISD** shall appoint a qualified liaison to communicate on behalf of **GPISD** with HCDE representatives. The liaison shall be knowledgeable in no less than the student(s)'s educational and disciplinary records; Highpoint School East programs, policies, and procedures; and special education law, policies, and procedure, if appropriate. The **GPISD** liaison shall make best efforts to assist Highpoint School East representatives in providing services to students, including, but not limited to, acquiring information regarding the student(s), assessing best placement, and communicating with **GPISD** employees and student(s)'s parents/guardians, as necessary.

**13. Termination.**

- a) HCDE shall have the right to terminate this Contract for convenience, effective at the end of the Term, or with at least thirty (30) calendar days prior written notice to **GPISD**. If HCDE exercises such termination right, HCDE shall have no obligation to refund to **GPISD** the amount of any pre-paid fees for any period following the effective date of such termination.
- b) Both Parties may terminate this Contract with or without cause by mutual written agreement.
- c) Upon the effective date of termination or expiration of this Contract, except as otherwise explicitly stated herein, the Parties shall have no obligations to the other Party under this Contract. Student(s) in attendance at Highpoint School East at the time of termination or expiration of this Contract will return to **GPISD**. All Student Records maintained by HCDE during the duration of providing services to the student will be provided to **GPISD** within ten (10) business days following the date of termination or expiration, at the written request of **GPISD**.

**14. Equal Opportunity.** It is the policy of HCDE not to discriminate on the basis of race, color, national origin, gender, limited English proficiency or handicapping conditions in its programs. **GPISD** agrees not to discriminate against any employee, student(s), or other person or party in the performance of this Contract, with respect to placement at Highpoint School East, services to be provided, conditions and privileges of employment, or a matter directly or indirectly related to age (except where based on a bona fide occupational qualification), sex (except where based on a bona fide occupational qualification), race, color, religion, national origin, or ancestry. Breach of this covenant may be regarded as a material breach of this Contract.

**15. Assignment.** Neither this Contract nor any duties or obligations under it shall be assignable by either Party without the prior written acknowledgment and authorization of the other Party.

**16. Notice.** Any notice provided under the terms of this Contract by either Party to the other shall be in writing and shall be deemed sufficient forty-eight (48) hours after being deposited in the regular mail as certified mail, return receipt requested, if such notice is addressed to the party to be notified at such Party's address as set forth below:

HCDE  
Attention: James Colbert, Jr., County School Superintendent  
6300 Irvington Boulevard  
Houston, Texas 77022-5618

**CISD**  
Attention: Dr. John Moore, Superintendent  
14705 Woodforest Boulevard  
Houston, Texas 77015

Each Party may change the address at which notice may be sent to that Party by giving notice of such change to the other Party in accordance with the provisions of this Article.

17. **Third Party Beneficiaries.** Nothing in this Contract shall be deemed or construed to create any third-party beneficiaries or otherwise give any third party any claim or right of action against any party to this Contract.
18. **Choice of Law and Venue.** This Contract shall be construed under the laws of the State of Texas, and mandatory and exclusive venue for any action arising out of this Contract shall be in Harris County, Texas.
19. **Amendments and Waivers.** Any term of this Contract may be amended or waived only with the written consent of the Parties or their respective permitted successors and assigns. Any amendment or waiver effected in accordance with this Article shall be binding upon the Parties and their respective successors and assigns.
20. **Separate Entities.** There is no relationship of agency, partnership, joint venture, employment, or franchise between the Parties. Neither Party has the authority to bind the other or to incur any obligation on its behalf. **GPISD** assumes full responsibility for the actions of its personnel while performing any services incident to this Contract, including, but not limited to, transportation and special education services, and shall remain solely responsible for their supervision, direction and control, payment of salary, workers' compensation, disability benefits, and like requirements and obligations. **GPISD** agrees that HCDE has no responsibility for any conduct of **GPISD** or **GPISD**'s employees, agents, representatives, contractors, or subcontractors.
21. **Authority.** Each Party acknowledges, represents, and warrants that it has the power and authority to enter into this Contract and to perform its obligations hereunder, without the need for any consents or approvals not yet obtained, except to the extent that this Contract requires approval of either Party's Board of Trustees.
22. **Force Majeure.** Neither HCDE nor **GPISD** shall be deemed to have breached any provision of this Contract as a result of any delay, failure in performance, or interruption of service resulting directly or indirectly from acts of God, network failures, acts of civil or military authorities, civil disturbances, wars, energy crises, fires, transportation contingencies, interruptions in third-party telecommunications or Internet equipment or service, other catastrophes, or any other occurrences which are reasonably beyond such party's control.
23. **Severability.** In the event that any one or more of the terms or provisions contained in this Contract shall for any reason be held to be invalid, illegal, or unenforceable in any respect, such invalidity, illegality, or unenforceability shall not affect any other provisions, and the Contract shall be construed as if such invalid, illegal, or unenforceable provision had never been contained in it. The failure of a

Party to enforce any provision of this Contract or to require performance by other party will not be deemed a waiver, or in any way affect the right of either party to enforce such provision thereafter.

**24. Contract Interpretation.** The Parties agree that the normal rules of construction that require that any ambiguities in this Contract are to be construed against the drafter shall not be employed in the interpretation of this Contract.

**25. Captions.** The captions herein are for convenience and identification purposes only, and not an integral part hereof, and are not to be considered in the interpretation of any part hereof.

**26. Entire Agreement.** This Contract contains and embraces the entire agreement between the parties, and neither it, nor any part of it may be changed, altered, modified, limited or extended, orally or by any agreement between the parties, unless such agreement by expressed in writing, signed and acknowledged by HCDE and **GPISD**.

DocuSigned by:  
*Sonyia George*  
\_\_\_\_\_  
District School Superintendent/Designee

5/12/2021  
\_\_\_\_\_  
Date

\_\_\_\_\_  
County School Superintendent/Designee

\_\_\_\_\_  
Date

For HCDE Office use only: Revenue Account No. 19910060700970 57250000 **Highpoint School East**



**INTERLOCAL AGREEMENT FOR SPECIALIZED SERVICES  
HIGHPOINT SCHOOL (HS) EAST**

**2021-2022 ANNUAL CONTRACT**

Pursuant to the Interlocal Cooperation Act, Chapter 791 of the Texas Government Code, Harris County Department of Education (“HCDE”) and **La Porte ISD**, (“**LPISD**”) hereby enter into an Interlocal Contract (“Contract”) for the purpose of providing educational and related services under the Texas Education Code (TEC), Chapter 37, for students who have been removed from **LPISD** for committing an offense described in TEC, Chapter 37, or for engaging in behavior(s) for which **LPISD** Student Code of Conduct requires a discipline alternative education placement.

1. **Term.** This Contract is for the term of **August 23, 2021** through **June 3, 2022**. During said term, HCDE agrees to provide services described herein for six (6) units to eligible student(s) requiring a discipline alternative education placement (referred to herein as “student(s)”) who are residents of **LPISD**.
2. **HCDE Responsibilities.**
  - a) HCDE agrees to provide specialized facilities and certified/licensed personnel necessary to provide educational, instructional, and counseling services to the student(s) placed at Highpoint in accordance with applicable law and during the days and times set forth by Highpoint. HCDE may perform the services contracted for herein by using its own employees or independent contractors. HCDE will not be held responsible for the services contracted herein if the necessary specialized facilities and properly certified/licensed personnel are unavailable.
  - b) HCDE agrees to furnish the **LPISD** with a weekly statement of student(s) attendance.
  - c) HCDE may provide transportation for the student(s) to and from field trips, vocational training, and similar activities, if written permission allowing HCDE to transport students is provided by the students’ parents/guardians.
  - d) HCDE agrees to maintain necessary records and accounts in order to assure that funds received from the **LPISD** have been expended for the services described herein. HCDE agrees to provide these records and other information as may be required by the **LPISD**.
3. **LPISD’s Responsibilities.**
  - a) **LPISD** is responsible for providing transportation for the student(s) to and from Highpoint. Location of pick-up and drop-off points and time of service will be mutually determined by representatives of **LPISD** and HCDE.
  - b) **LPISD** shall provide copies of all Student Records (as hereinafter defined) pertaining to the student(s) no later than five (5) HCDE business days prior to student(s)’s first day of attendance at Highpoint. **LPISD** agrees to furnish HCDE a copy of any additional pertinent documents regarding the student(s) that may be requested from or obtained by **LPISD** during the term of this Contract. Student Records to be provided by **LPISD** include, but are not limited to, the following: (a) a recommendation letter from the student(s)’s campus or **LPISD** stating explicitly why the student is being referred to Highpoint; (b) the student’s Middle School Plan (for students in grades 6-8) or the student’s Graduation Plan (for students in grades 9-12); (c) the student’s current transcript, including all achievement test records; (d) for special education students, the student’s current IEP, in accordance with Article 7 this Contract; (e) withdrawal form, which shall indicate the list of current courses in which the student is enrolled, the grade earned and the textbook and other instructional resources being used with that subject; and (f) the student’s



current year's attendance records. **LPISD** shall provide copies of additional records, including **LPISD** Records, as reasonably requested by HCDE.

- c) **LPISD** retains the responsibility to report **LPISD** student(s)'s average daily attendance and other required information through the Public Education Information Management System ("PEIMS").

4. **Student Records; Confidentiality.** For purposes of this Contract, "Student Records" shall be defined as student information including personal identifiers such as name, address, phone number, date of birth, Social Security number, and student identification number, and any student information protected by law, including "personally identifiable information" and student "education records" as those terms are defined by the Family Educational Rights and Privacy Act, 20 USC 1232g, as amended ("FERPA"); "personal information" as that term is defined in the Children's Online Privacy Protection Act of 1998 ("COPPA"); "personal information" as that term is defined in the Protection of Pupil Rights Amendment ("PPRA"); "personally identifiable information" as that term is defined in the Individuals with Disabilities Education Act, as amended ("IDEA"); "protected health information" as that term is defined in the Health Insurance Portability and Accountability Act of 1996 ("HIPAA"); and "personal identifying information" and "sensitive personal information" as defined under the Texas Identity Theft Enforcement and Protection Act (Chapter 521, Texas Business and Commerce Code).

Notwithstanding any contrary provision of this Contract, both Parties and their employees, agents, and subcontractors may access and use Student Records only as permitted by law for the purpose(s) for which the disclosure was made. Both Parties agree to abide by FERPA's limitations and requirements imposed on school officials, including, but not limited to, the requirements of 34 C.F.R. 99.33(a). HCDE and **LPISD** expressly agree that: (1) the services/functions to be provided by HCDE are services/functions for which **LPISD** would otherwise use its own employees; (2) both Parties have been determined to meet the criteria set forth in **LPISD**'s annual notification of FERPA rights for being school officials with legitimate educational interests in the Student Records; (3) **LPISD** is under HCDE's direct control with respect to **LPISD**'s access to, use of, and disclosure of Student Records as gathered and maintained by HCDE; (4) HCDE is under **LPISD**'s direct control with respect to HCDE's access to, use of, and disclosure of Student Records as gathered and maintained by HCDE; and (5) both Parties will use Student Records only for authorized purposes and will not re-disclose Student Records to other parties, unless each Party has specific authorization from the other Party to do so or the disclosure is otherwise permitted by applicable law, including without limitation, FERPA, HIPAA, COPPA, IDEA, PPRA and the Texas Identity Theft Enforcement and Protection Act.

5. **Immunity.** Nothing in this Contract shall be construed as a waiver or relinquishment of any governmental immunities or defenses on behalf of either Party or their respective trustees, officers, employees, and agents as a result of the execution of this Contract or performance of the functions or obligations described herein.
6. **Collaboration.** Both Parties agree to collaborate, as necessary, to administer the services described in this Contract and to act in the best interest of the student(s). Both Parties shall use collaborative problem-solving techniques and best efforts to resolve issues between the Parties as they may arise.
7. **Special Education Services.**
- a) Special education student(s) served under this Contract have been placed by the Admission, Review and Dismissal (ARD) Committee of the student(s)'s school of regular attendance within **LPISD** and recommended for services as described herein. The ARD Committee of **LPISD** has affirmed the classification and approved the recommendation of such contracted services. An HCDE representative must participate in the ARD Committee meeting considering the special education student(s)'s placement, and HCDE must confirm in writing the student's eligibility for the program prior to the ARD Committee's consideration of placement at Highpoint.

- b) HCDE is responsible for providing educational and support services to special education student(s) in the same manner those services are provided to non-disabled students. Any and all additional services and funding required to implement the student's Individualized Education Program (IEP) and/or 504 plan are to be provided by **LPISD**. **LPISD** may make such services available in conjunction with Highpoint or at a separate time and location, at the discretion of **LPISD** and the ARD Committee, with HCDE participation. If **LPISD** chooses to make such services available in conjunction with Highpoint, **LPISD** will cooperate with Highpoint to minimize disruption at Highpoint. If **LPISD** requires the student(s) to leave Highpoint during the school day, the IEP must include transportation as a related service.
  - c) HCDE will follow the IDEA and other applicable laws when considering dismissal and/or expulsion of a qualified special education student(s) from Highpoint.
  - d) **LPISD** agrees to invite an HCDE representative as a non-consensus member to any **LPISD** ARD Committee meeting for **LPISD** student(s) placed at Highpoint pursuant to this Contract.
8. **Local Education Agency.** Student(s) receiving services from HCDE pursuant to this Contract remain enrolled in **LPISD** and are considered students of **LPISD** for all purposes. **LPISD** remains the Local Education Agency ("LEA"), as that term is defined by the IDEA, and the "Recipient" as that term is defined by Section 504 of the Rehabilitation Act of 1973 ("Section 504"), and solely retains the obligation to provide and to ensure that any eligible **LPISD** student is provided a free appropriate public education ("FAPE") while receiving services from HCDE. **LPISD** retains all responsibilities required of the LEA pursuant to the IDEA, and required of the Recipient pursuant to Section 504, including, but not limited to, requirements regarding identification, evaluation, educational placement, the provision of FAPE, and procedural safeguards. For any dispute, including a special education complaint or due process hearing, arising under the IDEA, Section 504, or other applicable law regarding an **LPISD** student placed at HCDE, **LPISD** recognizes and acknowledges that HCDE is not the LEA or Recipient for the **LPISD** student and is in no way liable to the student, parent, or **LPISD** under the IDEA, Section 504, or other applicable law.
9. **Monitoring Student Progress.** HCDE will update **LPISD** on the progress of the referred student(s) at least once per semester, in a manner determined to be appropriate by HCDE, including, but not limited to, a grade report, summary of any formal disciplinary action, and summary of attendance. A member of the **LPISD** administrative staff will monitor, assess, and evaluate student's progress as established by this Contract, including at least one (1) on-site visit annually.
10. **Invoices and Payment.** In consideration of the services provided herein, **LPISD** agrees to pay HCDE an in-county fee of **\$60,294** and any additional fees in the following manner:
- i. **\$10,049** times the number of units purchased. **LPISD** will be billed twice a year and payment will be due upon receipt of invoice.
  - ii. **\$75.00** special education surcharge times the number of enrollment days for Special Education student(s).
  - iii. **\$115.00** per diem times the number of student(s) in attendance over the number of units purchased (**6**).
11. HCDE will bill **LPISD** for the amount of units purchased. Payment will be due within 30 days of the date of **LPISD**'s receipt of invoice, except as otherwise provided under section 2251.021 of the Texas Government Code. Payment obligations are non-cancelable, and fees paid are non-refundable. **LPISD** may sell unused units to another independent school district upon obtaining HCDE's prior written consent.
12. In the event that **LPISD** makes a payment to HCDE with a credit card, **LPISD** agrees to pay to HCDE a surcharge fee consisting of any applicable credit card fees and costs borne by HCDE,

including, without limitation, the processing fee(s) charged to HCDE by the credit card company(ies).

- c) HCDE agrees to maintain records and accounts to the extent necessary to assure that funds received from **LPISD** have been expended for the services described herein. HCDE agrees to provide these records and other information as may be requested and required by **LPISD**.
- d) Each Party paying for the performance of governmental functions and/or invoices must make those payments from current revenues available to the paying Party.

**11. Payment by Student(s) and Parents.** The parents of the student(s) placed at Highpoint shall not be charged for the services contracted under this Contract. Services needed by the student, if any, beyond the scope of the Contract shall be the responsibility of the student(s) and/or his/her parent or guardian.

**12. LPISD Liaison.** **LPISD** shall appoint a qualified liaison to communicate on behalf of **LPISD** with HCDE representatives. The liaison shall be knowledgeable in no less than the student(s)'s educational and disciplinary records; Highpoint School East programs, policies, and procedures; and special education law, policies, and procedure, if appropriate. The **LPISD** liaison shall make best efforts to assist Highpoint School East representatives in providing services to students, including, but not limited to, acquiring information regarding the student(s), assessing best placement, and communicating with **LPISD** employees and student(s)'s parents/guardians, as necessary.

**13. Termination.**

- a) HCDE shall have the right to terminate this Contract for convenience, effective at the end of the Term, or with at least thirty (30) calendar days prior written notice to **LPISD**. If HCDE exercises such termination right, HCDE shall have no obligation to refund to **LPISD** the amount of any pre-paid fees for any period following the effective date of such termination.
- b) Both Parties may terminate this Contract with or without cause by mutual written agreement.
- c) Upon the effective date of termination or expiration of this Contract, except as otherwise explicitly stated herein, the Parties shall have no obligations to the other Party under this Contract. Student(s) in attendance at Highpoint School East at the time of termination or expiration of this Contract will return to **LPISD**. All Student Records maintained by HCDE during the duration of providing services to the student will be provided to **LPISD** within ten (10) business days following the date of termination or expiration, at the written request of **LPISD**.

**14. Equal Opportunity.** It is the policy of HCDE not to discriminate on the basis of race, color, national origin, gender, limited English proficiency or handicapping conditions in its programs. **LPISD** agrees not to discriminate against any employee, student(s), or other person or party in the performance of this Contract, with respect to placement at Highpoint School East, services to be provided, conditions and privileges of employment, or a matter directly or indirectly related to age (except where based on a bona fide occupational qualification), sex (except where based on a bona fide occupational qualification), race, color, religion, national origin, or ancestry. Breach of this covenant may be regarded as a material breach of this Contract.

**15. Assignment.** Neither this Contract nor any duties or obligations under it shall be assignable by either Party without the prior written acknowledgment and authorization of the other Party.

**16. Notice.** Any notice provided under the terms of this Contract by either Party to the other shall be in writing and shall be deemed sufficient forty-eight (48) hours after being deposited in the regular mail as certified mail, return receipt requested, if such notice is addressed to the party to be notified at such Party's address as set forth below:

**HCDE**

Attention:  
James Colbert, Jr., County School Superintendent  
6300 Irvington Boulevard  
Houston, Texas 77022-5618

**LPISD**

Attention:  
Dr. Walter Jackson, Superintendent  
1002 San Jacinto Street  
La Porte, Texas 77571

Each Party may change the address at which notice may be sent to that Party by giving notice of such change to the other Party in accordance with the provisions of this Article.

- 17. Third Party Beneficiaries.** Nothing in this Contract shall be deemed or construed to create any third-party beneficiaries or otherwise give any third party any claim or right of action against any party to this Contract.
- 18. Choice of Law and Venue.** This Contract shall be construed under the laws of the State of Texas, and mandatory and exclusive venue for any action arising out of this Contract shall be in Harris County, Texas.
- 19. Amendments and Waivers.** Any term of this Contract may be amended or waived only with the written consent of the Parties or their respective permitted successors and assigns. Any amendment or waiver effected in accordance with this Article shall be binding upon the Parties and their respective successors and assigns.
- 20. Separate Entities.** There is no relationship of agency, partnership, joint venture, employment, or franchise between the Parties. Neither Party has the authority to bind the other or to incur any obligation on its behalf. **LPISD** assumes full responsibility for the actions of its personnel while performing any services incident to this Contract, including, but not limited to, transportation and special education services, and shall remain solely responsible for their supervision, direction and control, payment of salary, workers' compensation, disability benefits, and like requirements and obligations. **LPISD** agrees that HCDE has no responsibility for any conduct of **LPISD** or **LPISD**'s employees, agents, representatives, contractors, or subcontractors.
- 21. Authority.** Each Party acknowledges, represents, and warrants that it has the power and authority to enter into this Contract and to perform its obligations hereunder, without the need for any consents or approvals not yet obtained, except to the extent that this Contract requires approval of either Party's Board of Trustees.
- 22. Force Majeure.** Neither HCDE nor **LPISD** shall be deemed to have breached any provision of this Contract as a result of any delay, failure in performance, or interruption of service resulting directly or indirectly from acts of God, network failures, acts of civil or military authorities, civil disturbances, wars, energy crises, fires, transportation contingencies, interruptions in third-party telecommunications or Internet equipment or service, other catastrophes, or any other occurrences which are reasonably beyond such party's control.
- 23. Severability.** In the event that any one or more of the terms or provisions contained in this Contract shall for any reason be held to be invalid, illegal, or unenforceable in any respect, such invalidity, illegality, or unenforceability shall not affect any other provisions, and the Contract shall be construed as if such invalid, illegal, or unenforceable provision had never been contained in it. The failure of a

Party to enforce any provision of this Contract or to require performance by other party will not be deemed a waiver, or in any way affect the right of either party to enforce such provision thereafter.

**24. Contract Interpretation.** The Parties agree that the normal rules of construction that require that any ambiguities in this Contract are to be construed against the drafter shall not be employed in the interpretation of this Contract.

**25. Captions.** The captions herein are for convenience and identification purposes only, and not an integral part hereof, and are not to be considered in the interpretation of any part hereof.

**26. Entire Agreement.** This Contract contains and embraces the entire agreement between the parties, and neither it, nor any part of it may be changed, altered, modified, limited or extended, orally or by any agreement between the parties, unless such agreement by expressed in writing, signed and acknowledged by HCDE and LPISD.

Rhonda Cumbri  
District School Superintendent/Designee

6/24/2021  
Date

\_\_\_\_\_  
County School Superintendent/Designee

\_\_\_\_\_  
Date

For HCDE Office use only: Revenue Account No. 19910060700970 57250000 **Highpoint School East**



**INTERLOCAL AGREEMENT FOR SPECIALIZED SERVICES  
HIGHPOINT SCHOOL (HS) EAST**

**2021 – 2022 ANNUAL CONTRACT**

Pursuant to the Interlocal Cooperation Act, Chapter 791 of the Texas Government Code, Harris County Department of Education (“HCDE”) and **Spring Branch ISD, (“SBISD”)** hereby enter into an Interlocal Contract (“Contract”) for the purpose of providing educational and related services under the Texas Education Code (TEC), Chapter 37, for students who have been removed from **SBISD** for committing an offense described in TEC, Chapter 37, or for engaging in behavior(s) for which **SBISD** Student Code of Conduct requires a discipline alternative education placement.

1. **Term.** This Contract is for the term of **August 23, 2021** through **June 3, 2022**. During said term, HCDE agrees to provide services described herein for **eight (8)** units to eligible student(s) requiring a discipline alternative education placement (referred to herein as “student(s)”) who are residents of **SBISD**.
2. **HCDE Responsibilities.**
  - a) HCDE agrees to provide specialized facilities and certified/licensed personnel necessary to provide educational, instructional, and counseling services to the student(s) placed at Highpoint in accordance with applicable law and during the days and times set forth by Highpoint. HCDE may perform the services contracted for herein by using its own employees or independent contractors. HCDE will not be held responsible for the services contracted herein if the necessary specialized facilities and properly certified/licensed personnel are unavailable.
  - b) HCDE agrees to furnish the **SBISD** with a weekly statement of student(s) attendance.
  - c) HCDE may provide transportation for the student(s) to and from field trips, vocational training, and similar activities, if written permission allowing HCDE to transport students is provided by the students’ parents/guardians.
  - d) HCDE agrees to maintain necessary records and accounts in order to assure that funds received from the **SBISD** have been expended for the services described herein. HCDE agrees to provide these records and other information as may be required by the **SBISD**.
3. **SBISD’s Responsibilities.**
  - a) **SBISD** is responsible for providing transportation for the student(s) to and from Highpoint. Location of pick-up and drop-off points and time of service will be mutually determined by representatives of **SBISD** and HCDE.
  - b) **SBISD** shall provide copies of all Student Records (as hereinafter defined) pertaining to the student(s) no later than five (5) HCDE business days prior to student(s)’s first day of attendance at Highpoint. **SBISD** agrees to furnish HCDE a copy of any additional pertinent documents regarding the student(s) that may be requested from or obtained by **SBISD** during the term of this Contract. Student Records to be provided by **SBISD** include, but are not limited to, the following: (a) a recommendation letter from the student(s)’s campus or **SBISD** stating explicitly why the student is being referred to Highpoint; (b) the student’s Middle School Plan (for students in grades 6-8) or the student’s Graduation Plan (for students in grades 9-12); (c) the student’s current transcript, including all achievement test records; (d) for special education students, the student’s current IEP, in accordance with Article 7 this Contract; (e) withdrawal form, which shall indicate the list of current courses in which the student is enrolled, the grade earned and the textbook and other instructional resources being used with that subject; and (f) the student’s

current year's attendance records. **SBISD** shall provide copies of additional records, including **SBISD** Records, as reasonably requested by HCDE.

- c) **SBISD** retains the responsibility to report **SBISD** student(s)'s average daily attendance and other required information through the Public Education Information Management System ("PEIMS").

4. **Student Records; Confidentiality.** For purposes of this Contract, "Student Records" shall be defined as student information including personal identifiers such as name, address, phone number, date of birth, Social Security number, and student identification number, and any student information protected by law, including "personally identifiable information" and student "education records" as those terms are defined by the Family Educational Rights and Privacy Act, 20 USC 1232g, as amended ("FERPA"); "personal information" as that term is defined in the Children's Online Privacy Protection Act of 1998 ("COPPA"); "personal information" as that term is defined in the Protection of Pupil Rights Amendment ("PPRA"); "personally identifiable information" as that term is defined in the Individuals with Disabilities Education Act, as amended ("IDEA"); "protected health information" as that term is defined in the Health Insurance Portability and Accountability Act of 1996 ("HIPAA"); and "personal identifying information" and "sensitive personal information" as defined under the Texas Identity Theft Enforcement and Protection Act (Chapter 521, Texas Business and Commerce Code).

Notwithstanding any contrary provision of this Contract, both Parties and their employees, agents, and subcontractors may access and use Student Records only as permitted by law for the purpose(s) for which the disclosure was made. Both Parties agree to abide by FERPA's limitations and requirements imposed on school officials, including, but not limited to, the requirements of 34 C.F.R. 99.33(a). HCDE and **SBISD** expressly agree that: (1) the services/functions to be provided by HCDE are services/functions for which **SBISD** would otherwise use its own employees; (2) both Parties have been determined to meet the criteria set forth in **SBISD**'s annual notification of FERPA rights for being school officials with legitimate educational interests in the Student Records; (3) **SBISD** is under HCDE's direct control with respect to **SBISD**'s access to, use of, and disclosure of Student Records as gathered and maintained by HCDE; (4) HCDE is under **SBISD**'s direct control with respect to HCDE's access to, use of, and disclosure of Student Records as gathered and maintained by HCDE; and (5) both Parties will use Student Records only for authorized purposes and will not re-disclose Student Records to other parties, unless each Party has specific authorization from the other Party to do so or the disclosure is otherwise permitted by applicable law, including without limitation, FERPA, HIPAA, COPPA, IDEA, PPRA and the Texas Identity Theft Enforcement and Protection Act.

5. **Immunity.** Nothing in this Contract shall be construed as a waiver or relinquishment of any governmental immunities or defenses on behalf of either Party or their respective trustees, officers, employees, and agents as a result of the execution of this Contract or performance of the functions or obligations described herein.
6. **Collaboration.** Both Parties agree to collaborate, as necessary, to administer the services described in this Contract and to act in the best interest of the student(s). Both Parties shall use collaborative problem-solving techniques and best efforts to resolve issues between the Parties as they may arise.
7. **Special Education Services.**
- a) Special education student(s) served under this Contract have been placed by the Admission, Review and Dismissal (ARD) Committee of the student(s)'s school of regular attendance within **SBISD** and recommended for services as described herein. The ARD Committee of **SBISD** has affirmed the classification and approved the recommendation of such contracted services. An HCDE representative must participate in the ARD Committee meeting considering the special education student(s)'s placement, and HCDE must confirm in writing the student's eligibility for the program prior to the ARD Committee's consideration of placement at Highpoint.

- b) HCDE is responsible for providing educational and support services to special education student(s) in the same manner those services are provided to non-disabled students. Any and all additional services and funding required to implement the student's Individualized Education Program (IEP) and/or 504 plan are to be provided by **SBISD**. **SBISD** may make such services available in conjunction with Highpoint or at a separate time and location, at the discretion of **SBISD** and the ARD Committee, with HCDE participation. If **SBISD** chooses to make such services available in conjunction with Highpoint, **SBISD** will cooperate with Highpoint to minimize disruption at Highpoint. If **SBISD** requires the student(s) to leave Highpoint during the school day, the IEP must include transportation as a related service.
  - c) HCDE will follow the IDEA and other applicable laws when considering dismissal and/or expulsion of a qualified special education student(s) from Highpoint.
  - d) **SBISD** agrees to invite an HCDE representative as a non-consensus member to any **SBISD** ARD Committee meeting for **SBISD** student(s) placed at Highpoint pursuant to this Contract.
- 8. Local Education Agency.** Student(s) receiving services from HCDE pursuant to this Contract remain enrolled in **SBISD** and are considered students of **SBISD** for all purposes. ISD remains the Local Education Agency ("LEA"), as that term is defined by the IDEA, and the "Recipient" as that term is defined by Section 504 of the Rehabilitation Act of 1973 ("Section 504"), and solely retains the obligation to provide and to ensure that any eligible **SBISD** student is provided a free appropriate public education ("FAPE") while receiving services from HCDE. **SBISD** retains all responsibilities required of the LEA pursuant to the IDEA, and required of the Recipient pursuant to Section 504, including, but not limited to, requirements regarding identification, evaluation, educational placement, the provision of FAPE, and procedural safeguards. For any dispute, including a special education complaint or due process hearing, arising under the IDEA, Section 504, or other applicable law regarding an **SBISD** student placed at HCDE, **SBISD** recognizes and acknowledges that HCDE is not the LEA or Recipient for the **SBISD** student and is in no way liable to the student, parent, or **SBISD** under the IDEA, Section 504, or other applicable law.
- 9. Monitoring Student Progress.** HCDE will update **SBISD** on the progress of the referred student(s) at least once per semester, in a manner determined to be appropriate by HCDE, including, but not limited to, a grade report, summary of any formal disciplinary action, and summary of attendance. A member of the **SBISD** administrative staff will monitor, assess, and evaluate student's progress as established by this Contract, including at least one (1) on-site visit annually.
- 10. Invoices and Payment.** In consideration of the services provided herein, **SBISD** agrees to pay HCDE an in-county fee of **\$80,392** and any additional fees in the following manner:
- i. **\$10,049** times the number of units purchased. **SBISD** will be billed twice a year and payment will be due upon receipt of invoice.
  - ii. **\$75.00** special education surcharge times the number of enrollment days for Special Education student(s).
  - iii. **\$115.00** per diem times the number of student(s) in attendance over the number of units purchased (**8**).
- a) HCDE will bill **SBISD** for the amount of units purchased. Payment will be due within 30 days of the date of **SBISD**'s receipt of invoice. Payment obligations are non-cancelable, and fees paid are non-refundable. **SBISD** may sell unused units to another independent school district upon obtaining HCDE's prior written consent.
  - b) In the event that **SBISD** makes a payment to HCDE with a credit card, **SBISD** agrees to pay to HCDE a surcharge fee consisting of any applicable credit card fees and costs borne by HCDE,



including, without limitation, the processing fee(s) charged to HCDE by the credit card company(ies).

- c) HCDE agrees to maintain records and accounts to the extent necessary to assure that funds received from **SBISD** have been expended for the services described herein. HCDE agrees to provide these records and other information as may be requested and required by **SBISD**.
- d) Each Party paying for the performance of governmental functions and/or invoices must make those payments from current revenues available to the paying Party.

**11. Payment by Student(s) and Parents.** The parents of the student(s) placed at Highpoint shall not be charged for the services contracted under this Contract. Services needed by the student, if any, beyond the scope of the Contract shall be the responsibility of the student(s) and/or his/her parent or guardian.

**12. SBISD Liaison.** **SBISD** shall appoint a qualified liaison to communicate on behalf of **SBISD** with HCDE representatives. The liaison shall be knowledgeable in no less than the student(s)'s educational and disciplinary records; Fortis Academy programs, policies, and procedures; and special education law, policies, and procedure, if appropriate. The **SBISD** liaison shall make best efforts to assist Fortis Academy representatives in providing services to students, including, but not limited to, acquiring information regarding the student(s), assessing best placement, and communicating with **SBISD** employees and student(s)'s parents/guardians, as necessary.

**13. Termination.**

- a) HCDE shall have the right to terminate this Contract for convenience, effective at the end of the Term, or with at least thirty (30) calendar days prior written notice to **SBISD**. If HCDE exercises such termination right, HCDE shall have no obligation to refund to **SBISD** the amount of any pre-paid fees for any period following the effective date of such termination.
- b) Both Parties may terminate this Contract with or without cause by mutual written agreement.
- c) Upon the effective date of termination or expiration of this Contract, except as otherwise explicitly stated herein, the Parties shall have no obligations to the other Party under this Contract. Student(s) in attendance at Fortis Academy at the time of termination or expiration of this Contract will return to **SBISD**. All Student Records maintained by HCDE during the duration of providing services to the student will be provided to **SBISD** within ten (10) business days following the date of termination or expiration, at the written request of **SBISD**.

**14. Equal Opportunity.** It is the policy of HCDE not to discriminate on the basis of race, color, national origin, gender, limited English proficiency or handicapping conditions in its programs. **SBISD** agrees not to discriminate against any employee, student(s), or other person or party in the performance of this Contract, with respect to placement at Fortis Academy, services to be provided, conditions and privileges of employment, or a matter directly or indirectly related to age (except where based on a bona fide occupational qualification), sex (except where based on a bona fide occupational qualification), race, color, religion, national origin, or ancestry. Breach of this covenant may be regarded as a material breach of this Contract.

**15. Assignment.** Neither this Contract nor any duties or obligations under it shall be assignable by either Party without the prior written acknowledgment and authorization of the other Party.

**16. Notice.** Any notice provided under the terms of this Contract by either Party to the other shall be in writing and shall be deemed sufficient forty-eight (48) hours after being deposited in the regular mail as certified mail, return receipt requested, if such notice is addressed to the party to be notified at such Party's address as set forth below:

HCDE  
Attention: James Colbert, Jr., County School Superintendent  
6300 Irvington Boulevard  
Houston, Texas 77022-5618

**SBISD**  
Attention: Dr. Jennifer Blaine, Superintendent  
955 Campbell Road  
Houston, Texas 77024

Each Party may change the address at which notice may be sent to that Party by giving notice of such change to the other Party in accordance with the provisions of this Article.

- 17. Third Party Beneficiaries.** Nothing in this Contract shall be deemed or construed to create any third-party beneficiaries or otherwise give any third party any claim or right of action against any party to this Contract.
- 18. Choice of Law and Venue.** This Contract shall be construed under the laws of the State of Texas, and mandatory and exclusive venue for any action arising out of this Contract shall be in Harris County, Texas.
- 19. Amendments and Waivers.** Any term of this Contract may be amended or waived only with the written consent of the Parties or their respective permitted successors and assigns. Any amendment or waiver effected in accordance with this Article shall be binding upon the Parties and their respective successors and assigns.
- 20. Separate Entities.** There is no relationship of agency, partnership, joint venture, employment, or franchise between the Parties. Neither Party has the authority to bind the other or to incur any obligation on its behalf. **SBISD** assumes full responsibility for the actions of its personnel while performing any services incident to this Contract, including, but not limited to, transportation and special education services, and shall remain solely responsible for their supervision, direction and control, payment of salary, workers' compensation, disability benefits, and like requirements and obligations. **SBISD** agrees that HCDE has no responsibility for any conduct of **SBISD** or **SBISD's** employees, agents, representatives, contractors, or subcontractors.
- 21. Authority.** Each Party acknowledges, represents, and warrants that it has the power and authority to enter into this Contract and to perform its obligations hereunder, without the need for any consents or approvals not yet obtained, except to the extent that this Contract requires approval of either Party's Board of Trustees.
- 22. Force Majeure.** Neither HCDE nor **SBISD** shall be deemed to have breached any provision of this Contract as a result of any delay, failure in performance, or interruption of service resulting directly or indirectly from acts of God, network failures, acts of civil or military authorities, civil disturbances, wars, energy crises, fires, transportation contingencies, interruptions in third-party telecommunications or Internet equipment or service, other catastrophes, or any other occurrences which are reasonably beyond such party's control.
- 23. Severability.** In the event that any one or more of the terms or provisions contained in this Contract shall for any reason be held to be invalid, illegal, or unenforceable in any respect, such invalidity, illegality, or unenforceability shall not affect any other provisions, and the Contract shall be construed as if such invalid, illegal, or unenforceable provision had never been contained in it. The failure of a Party to enforce any provision of this Contract or to require performance by other party will not be deemed a waiver, or in any way affect the right of either party to enforce such provision thereafter.

**24. Contract Interpretation.** The Parties agree that the normal rules of construction that require that any ambiguities in this Contract are to be construed against the drafter shall not be employed in the interpretation of this Contract.

**25. Captions.** The captions herein are for convenience and identification purposes only, and not an integral part hereof, and are not to be considered in the interpretation of any part hereof.

**26. Entire Agreement.** This Contract contains and embraces the entire agreement between the parties, and neither it, nor any part of it may be changed, altered, modified, limited or extended, orally or by any agreement between the parties, unless such agreement by expressed in writing, signed and acknowledged by HCDE and **SBISD**.

*Richard L Gay*

\_\_\_\_\_  
District School Superintendent/Designee

6/24/2021

\_\_\_\_\_  
Date

\_\_\_\_\_  
County School Superintendent/Designee

\_\_\_\_\_  
Date

For HCDE Office use only: Revenue Account No. 19910060700970 57250000 **Highpoint School East**

**Regular Board Meeting**

**8.D.5.**

**Meeting Date:** July 21, 2021  
**Title:** Schools Division ABS West- ESY Contract FY21 for Summer School: Fort Bend (16)

**Submitted For:** Anthony Mays, Schools

**Submitted By:** Denise Alamos

**Recommended Action:** Approve

**HCDE Goal(s):** 3. Advocate for learners through innovation

**Additional Resource Personnel:** Jonathan Parker, Charles Ned, Dr. Jesus Amezcua, Kendra Jackson

**Facilities/Technology Approval Needed?:**

**Information**

**Posted Agenda Item:**

**Approval of Interlocal (revenue) contract for Summer School FY 2021 in the aggregate amount of \$92,896 with Academic and Behavior School West with the following district:** Fort Bend ISD for sixteen (16) out-of-county Extended School Year (ESY-Summer School) contracts in the amount of \$92,896 (\$5,806 each) for the time period of 06/14/2021 through 07/16/2021.

**Subject:**

**Approval of Interlocal (revenue) contract for Summer School FY 2021 in the aggregate amount of \$92,896 with Academic and Behavior School West with the following district:** Fort Bend ISD for sixteen (16) out-of-county Extended School Year (ESY-Summer School) contracts in the amount of \$92,896 (\$5,806 each) for the time period of 06/14/2021 through 07/16/2021.

**Rationale:**

Entity	Description	Dates	Total
Fort Bend ISD	ESY (Summer School) Contract (15) (out of-county \$5,806 each)	6/14/21-7/16/21	\$92,896
Total			\$92,896

**Fiscal Impact**

**Included in FY budget Y/N:** Y

**Included in current budget amendment Y/N:** N

**Attachments**

FY21 ABSW-ESY Fort Bend ISD 16\_ \$92,896

**Form Review**

**Inbox**

Purchasing  
Assistant Superintendent - Business  
Form Started By: Denise Alamos  
Final Approval Date: 07/09/2021

**Reviewed By**

Kendra Jackson  
Jesus Amezcua

**Date**

07/06/2021 12:58 PM  
07/09/2021 03:54 PM  
Started On: 06/28/2021 03:07 PM



**UNIT CONTRACT  
ACADEMIC AND BEHAVIOR SCHOOL - WEST  
SUMMER SCHOOL PROGRAM FY21  
(EXTENDED SCHOOL YEAR SERVICES-ESY)**

Pursuant to the Interlocal Cooperation Act, Chapter 791 of the Texas Government Code, Harris County Department of Education (“**HCDE**”) and the **Fort Bend Independent School District**, (“**FBISD**”) hereby enter into an Interlocal Contract (“**Contract**”) for the purpose of providing educational and related services for eligible students with disabilities of the **FBISD** and to state the terms, rights and duties of the contracting parties.

1. For the period beginning **June 14, 2021** through **July 16, 2021**, **HCDE** agrees to provide services described herein for **sixteen (16) unit: Adaptive Behavior/Life Skills** to eligible student(s) with disabilities (referred to herein as “student(s)”) who are residents of the **FBISD**.
2. **HCDE** agrees to provide specialized facilities and properly certified/licensed personnel necessary to appropriately educate and provide instructional and counseling services to the student(s) in accordance with applicable law. During the period of this agreement, if **HCDE** fails to provide the necessary specialized facilities and certified personnel, the **FBISD** may terminate services until such time as **HCDE** can provide the necessary specialized services contracted herein. **HCDE** will not be held responsible for the services contracted herein if the necessary specialized facilities and properly certified/licensed personnel are unavailable.
3. **HCDE** agrees to furnish the **FBISD** with a monthly statement of student attendance.
4. **HCDE** agrees to maintain necessary records and accounts in order to assure that funds received from the **FBISD** have been expended for the services described herein. **HCDE** agrees to provide these records and other information as may be required by the **FBISD**.
5. The students served under this Contract have been classified by the Admission, Review and Dismissal (ARD) Committee of the school of regular attendance within the **FBISD** and recommended for services as described herein. The ARD Committee of the **FBISD** has affirmed the classification and approved the recommendation of such contracted services.
6. **FBISD** will provide copies of all pertinent school records on the student(s) with parental or guardian permission. **FBISD** agrees to furnish **HCDE** a copy of any additional pertinent documents regarding the student(s) which may be obtained by the **FBISD** during the term of this Contract. **HCDE** will be available for participation with the **FBISD** ARD Committee in the development of the Individualized Education Plan (IEP). **HCDE** will update the **FBISD** on the implementation of the IEP at least once per semester. A member of the **FBISD** Special Education personnel will monitor, assess and evaluate the student(s)’s progress as established by the IEP, including at least one on-site visit annually.
7. In consideration of the services provided herein, the **FBISD** agrees to pay **HCDE** **\$5,806** per unit for a total of **\$92,896**. Payment will be due upon receipt of invoice.  
  
In the event that **FBISD** makes a payment to **HCDE** with a credit card, **FBISD** agrees to pay to **HCDE** a surcharge fee consisting of any applicable credit card fees and costs borne by **HCDE**, including, without limitation, the processing fee(s) charged to **HCDE** by the credit card company(ies).
8. The source of funding for this contract will be from federal and local (federal, state or local) funds. The parents of the students shall not be charged for the services contracted under this Contract.
9. **HCDE** will follow IDEA and other applicable laws when considering dismissal and/or expulsion.
10. This Contract may be amended only by the mutual agreement of the parties, in a writing to be attached to and incorporated in this Contract.

- 11. Each party paying for the performance of governmental functions must make those payments from current revenues available to the paying party.
- 12. Neither this Contract nor any duties or obligations under it shall be assignable by either party without the prior written acknowledgment and authorization of the other party.
- 13. Any notice provided under the terms of this Contract by either party to the other shall be in writing and may be affected by certified mail, return receipt requested. Notice shall be sufficient if made or addressed as follows:

**HCDE**

Attention:  
 James Colbert, Jr., County School Superintendent 6300  
 Irvington Boulevard  
 Houston, Texas 77022-5618

**FBISD**

Attention:  
 Diana Sayavedra, Acting Superintendent of Schools  
 16431 Lexington Blvd  
 Sugar Land, TX 77479

Each party may change the address at which notice may be sent to that party by giving notice of such change to the other party in accordance with the provisions of this Article.

- 14. This Contract shall be construed under the laws of the State of Texas and mandatory and exclusive venue in any action arising out of this Contract shall be in Harris County, Texas.
- 15. This Contract does not create a joint venture or business partnership under Texas law.
- 16. Each party acknowledges that this Contract has been authorized by the governing body of each party to the Contract.
- 18. In the event that any one or more of the provisions contained in this Contract shall for any reason be held to be invalid, illegal, or unenforceable in any respect, such invalidity, illegality, or unenforceability shall not affect any other provisions, and the Contract shall be construed as if such invalid, illegal, or unenforceable provision had never been contained in it.

*Diana Sayavedra*

June 21, 2021 | 10:18 AM CDT

\_\_\_\_\_  
 Diana Sayavedra  
 Acting Superintendent of Schools

\_\_\_\_\_  
 Date

\_\_\_\_\_  
 Harris County School Superintendent

\_\_\_\_\_  
 Date

For FBISD Office use only: Revenue Account No. 19910060200132 57250001 ABS-West

**ADDENDUM TO  
INTERLOCAL AGREEMENT FOR SPECIALIZED SERVICES ACADEMIC BEHAVIOR CENTER (ABC)  
2020-2021 EXTENDED SCHOOL YEAR SERVICES - ESY**

This Addendum is in reference to the Interlocal Agreement for Specialized Services Academic Behavior Center (ABC) 2020-2021 Extended School Year Services - ESY between Harris County Department of Education and Fort Bend Independent School District.

**PROVISIONS RELATED TO FEDERAL CONTRACTORS (EDGAR):** This section is applicable only for services to be paid with federal funds. If federal funds will be used to pay for Services under this Agreement, the Parties understand and agree that this Agreement is subject to appropriation, approval, and disbursement of such funding by the United States federal government and its funding administrators, including, but not limited to, the Texas Education Agency. As applicable, the Parties agree to comply with any terms, conditions, and policies related to the use of federal funds, including, but not limited to, the Education Department General Administrative Regulations (“EDGAR”) and any other requirements related to applying for, receiving, managing, and reporting federal funds. Contractor shall complete the “EDGAR Certification” attached as Exhibit A and incorporated by reference. Noncompliance or misrepresentation regarding this certification may be grounds for termination of this Agreement. Notwithstanding any contrary provision of this Agreement, if FBISD does not receive sufficient funding for Services under this Agreement, upon written notice to Contractor, FBISD may terminate this Agreement without penalty or further obligation to Contractor at the end of the period for which funding is available.

All professional services contracts paid with federal grants shall be effective only during the period of availability of the funds identified in the Notice of Grant Award (“NOGA”). This Agreement is effective only after the NOGA is issued. This agreement identifies and lists only reasonable, necessary, and allocable services to be provided during the period of availability of the funding sources listed in the contract. The administrative costs charged to the grant in the contract must comply with any limitations for administrative costs for funding sources (if applicable).

The undersigned parties agree the completed exhibits listed below are fully incorporated and included as a part of the original contract:

1. Exhibit A – EDGAR Certifications for Vendors,
2. Confidential Student Information Agreement Exhibit B to Specialized Services Agreement and Access Agreement,
3. Exhibit C – Contractor Certification,
4. Exhibit D – Conflict of Interest Questionnaire (CIQ),
5. Exhibit E – Felony Conviction Notice,
6. Exhibit F – Suspension and Debarment Certification,
7. Exhibit G – Relationships with Foreign Entities Language; and,
8. Exhibit H – Data Protection Addendum.

No other terms or conditions of the above mentioned contract shall be negated or changed as a result of this addendum.

**HARRIS COUNTY DEPARTMENT OF EDUCATION:**

\_\_\_\_\_  
Signature

\_\_\_\_\_  
Date

James Colbert, Jr.  
Print Name



**EXHIBIT A****2 CFR SECTION 200 REQUIRED PROVISIONS  
ADDENDUM FOR CONTRACT FUNDED BY U.S. FEDERAL GRANT**

The following certifications and provisions are required and apply only when the District expends federal funds for any contract resulting from this procurement process. **Accordingly, the parties agree that the following terms and conditions apply to the Contract between the District and vendor (“Vendor”) in all situations where Vendor has been paid or will be paid with federal funds, and only to the extent applicable to the contract type or dollar amount:**

---



---

**REQUIRED CONTRACT PROVISIONS FOR NON-FEDERAL ENTITY CONTRACTS UNDER FEDERAL AWARDS**

---

**APPENDIX II TO 2 CFR PART 200**

---

**(A) [Applicable ONLY to contracts in excess of \$250,000.] Contracts for more than the simplified acquisition threshold currently set at \$250,000, which is the inflation adjusted amount determined by the Civilian Agency Acquisition Council and the Defense Acquisition Regulations Council (Councils) as authorized by 41 U.S.C. 1908, must address administrative, contractual, or legal remedies in instances where contractors violate or breach contract terms, and provide for such sanctions and penalties as appropriate.**

Pursuant to Federal Rule (A) above, when the District expends federal funds, the District reserves all rights and privileges under the applicable laws and regulations with respect to this procurement in the event of breach of contract by either party.

**(B) [Applicable ONLY to contracts in excess of \$10,000.] Termination for cause and for convenience by the grantee or subgrantee including the manner by which it will be affected and the basis for settlement.**

Pursuant to Federal Rule (B) above, when the District expends federal funds, the District reserves the right to immediately terminate any agreement in excess of \$10,000 resulting from this procurement process in the event of a breach or default of the agreement by Vendor in the event Vendor fails to: (1) meet schedules, deadlines, and/or delivery dates within the time specified in the procurement solicitation, contract, and/or a purchase order; (2) make any payments owed; or (3) otherwise perform in accordance with the contract and/or the procurement solicitation. The District also reserves the right to terminate the contract immediately, with written notice to vendor, for convenience, if the District believes, in its sole discretion that it is in the best interest of the District to do so. Vendor will be compensated for work performed and accepted and goods accepted by the District as of the termination date if the contract is terminated for convenience of the District. Any award under this procurement process is not exclusive and the District reserves the right to purchase goods and services from other vendors when it is in the District's best interest.

**(C) [Applicable ONLY to federally assisted construction contracts.] Equal Employment Opportunity. Except as otherwise provided under 41 CFR Part 60, all contracts that meet the definition of “federally assisted construction contract” in 41 CFR Part 60-1.3 must include the equal opportunity clause provided under 41 CFR 60-1.4(b), in accordance with Executive Order 11246, “Equal Employment Opportunity” (30 FR 12319, 12935, 3 CFR Part, 1964-1965 Comp., p. 339), as amended by Executive Order 11375, “Amending Executive Order 11246 Relating to Equal Employment Opportunity,” and implementing regulations at 41 CFR part 60, “Office of Federal Contract Compliance Programs, Equal Employment Opportunity, Department of Labor.”**

Pursuant to Federal Rule (C) above, when the District expends federal funds on any federally assisted construction contract, the equal opportunity clause is incorporated by reference herein.

**(D) [Applicable ONLY to prime construction contracts in excess of \$2,000 where federal funds are being used for the project] Davis-Bacon Act, as amended (40 U.S.C. 3141-3148). When required by Federal program legislation, prime construction contracts must include a provision for compliance with the Davis-Bacon Act (40 U.S.C. 3141-3144, and 3146-3148) as supplemented by Department of Labor regulations(29 CFR Part 5, “Labor Standards Provisions Applicable to Contracts Covering Federally Financed and Assisted Construction”). In accordance with the statute, contractors must be required to pay wages to laborers and mechanics at a rate not less than the prevailing wages specified in a wage determination made by the Secretary of Labor. In addition, contractors must be required to pay wages not less than once a week. The non-Federal entity must place a copy of the current prevailing wage determination issued by the Department of Labor in each solicitation. The decision to award a contract or subcontract must be conditioned upon the acceptance of the wage determination. The non-Federal entity must report all suspected or reported violations to the Federal awarding agency. The contracts must also include a provision for compliance with the Copeland “Anti-Kickback” Act (40 U.S.C. 3145), as supplemented by Department of Labor regulations (29 CFR Part 3, “Contractors and Subcontractors on Public Building or Public Work Financed in Whole or in Part by Loans or Grants from the United States”). The Act provides that each contractor or subrecipient must be prohibited from inducing, by any means, any person employed in the construction, completion, or repair of public work, to give up any part of the compensation to which he or she is otherwise entitled. The non-Federal entity must report all suspected or reported violations to the Federal awarding agency.**

Pursuant to Federal Rule (D) above, when FBISD expends federal funds during the term of an award for all contracts and subgrants for construction or repair, Vendor will be in compliance with all applicable Davis-Bacon Act provisions.

**(E) [Applicable ONLY to contracts in excess of \$100,000 involving mechanics or laborers.] Contract Work Hours and Safety Standards Act (40 U.S.C. 3701-3708). Where applicable, all contracts awarded by the non-Federal entity in excess of \$100,000 that involve the employment of mechanics or laborers must include a provision for compliance with 40 U.S.C. 3702 and 3704, as supplemented by Department of Labor regulations (29 CFR Part 5). Under 40 U.S.C. 3702 of the Act, each contractor must be required to compute the wages of every mechanic and laborer on the basis of a standard work week of 40 hours. Work in excess of the standard work week is permissible provided that the worker is compensated at a rate of not less than one and a half times the basic rate of pay for all hours worked in excess of 40 hours in the work week. The requirements of 40 U.S.C. 3704 are applicable to construction work and provide that no laborer or mechanic must be required to work in surroundings or under working conditions which are unsanitary, hazardous or dangerous. These requirements do not apply to the purchases of supplies or materials or articles ordinarily available on the open market, or contracts for transportation or transmission of intelligence.**

Pursuant to Federal Rule (E) above, when the District expends federal funds, Vendor certifies that Vendor will be in compliance with all applicable provisions of the Contract Work Hours and Safety Standards Act during the term of an award for all contracts by the District resulting from this procurement process.

**(F) Rights to Inventions Made Under a Contract or Agreement. If the Federal award meets the definition of “funding agreement” under 37 CFR §401.2 (a) and the recipient or subrecipient wishes to enter into a contract with a small business firm or nonprofit organization regarding the substitution of parties, assignment or performance of experimental, developmental, or research work under that “funding agreement,” the recipient or subrecipient must comply with the requirements of 37 CFR Part 401, “Rights to Inventions Made by Nonprofit Organizations and Small Business Firms Under Government Grants, Contracts and Cooperative Agreements,” and any implementing regulations issued by the awarding agency.**

Pursuant to Federal Rule (F) above, when federal funds are expended by the District, Vendor certifies that during the term of an award for all contracts by the District resulting from this procurement process, Vendor agrees to comply with all applicable requirements as referenced in Federal Rule (F) above.

**(G) [Applicable ONLY to contracts in excess of \$250,000.] Clean Air Act (42 U.S.C. 7401-7671q.) and the Federal Water Pollution Control Act (33 U.S.C. 1251-1387), as amended—Contracts and subgrants of amounts in excess of \$250,000 must contain a provision that requires the non-Federal award to agree to comply with all applicable standards, orders or regulations issued pursuant to the Clean Air Act (42 U.S.C. 7401-7671q) and the Federal Water Pollution Control Act as amended (33 U.S.C. 1251- 1387). Violations must be reported to the Federal awarding agency and the Regional Office of the Environmental Protection Agency (EPA).**

Pursuant to Federal Rule (G) above, when federal funds are expended by the District, Vendor certifies that during the term of an award for all contracts by the District resulting from this procurement process, Vendor agrees to comply with all applicable requirements as referenced in Federal Rule (G) above.

**(H) Debarment and Suspension (Executive Orders 12549 and 12689)—A contract award (see 2 CFR 180.220) must not be made to parties listed on the government wide exclusions in the System for Award Management (SAM), in accordance with the OMB guidelines at 2 CFR 180 that implement Executive Orders 12549 (3 CFR part 1986 Comp., p. 189) and 12689 (3 CFR part 1989 Comp., p. 235), “Debarment and Suspension.” SAM Exclusions contains the names of parties debarred, suspended, or otherwise excluded by agencies, as well as parties declared ineligible under statutory or regulatory authority other than Executive Order 12549.**

Pursuant to Federal Rule (H) above, when federal funds are expended by the District, Vendor certifies that during the term of an award for all contracts by the District resulting from this procurement process, Vendor certifies that neither it nor its principals is presently debarred, suspended, proposed for debarment, declared ineligible, or voluntarily excluded from participation by any federal department or agency.

**(I) [Applicable ONLY to contracts in excess of \$100,000] Byrd Anti-Lobbying Amendment (31 U.S.C. 1352)—Contractors that apply or bid for an award exceeding \$100,000 must file the required certification. Each tier certifies to the tier above that it will not and has not used Federal appropriated funds to pay any person or organization for influencing or attempting to influence an officer or employee of any agency, a member of Congress, officer or employee of Congress, or an employee of a member of Congress in connection with obtaining any Federal contract, grant or any other award covered by 31 U.S.C. 1352. Each tier must also disclose any lobbying with non-Federal funds that takes place in connection with obtaining any Federal award. Such disclosures are forwarded from tier to tier up to the non-Federal award.**

Pursuant to Federal Rule (I) above, when federal funds are expended by the District, Vendor certifies that during the term and after the awarded term of an award for all contracts by the District resulting from this procurement process, the vendor certifies that it is in compliance with all applicable provisions of the Byrd Anti-Lobbying Amendment (31 U.S.C. 1352). The undersigned further certifies that:

- (1) No Federal appropriated funds have been paid or will be paid for on behalf of the undersigned, to any person for influencing or attempting to influence an officer or employee of any agency, a Member of Congress, an officer or employee of congress, or an employee of a Member of Congress in connection with the awarding of a Federal contract, the making of a Federal grant, the making of a Federal loan, the entering into a cooperative

- agreement, and the extension, continuation, renewal, amendment, or modification of a Federal contract, grant, loan, or cooperative agreement.
- (2) If any funds other than Federal appropriated funds have been paid or will be paid to any person for influencing or attempting to influence an officer or employee of any agency, a Member of Congress, an officer or employee of congress, or an employee of a Member of Congress in connection with this Federal grant or cooperative agreement, the undersigned shall complete and submit Standard Form-LLL, "Disclosure Form to Report Lobbying", in accordance with its instructions.
  - (3) The undersigned shall require that the language of this certification be included in the award documents for all covered sub-awards exceeding \$100,000 in Federal funds at all appropriate tiers and that all subrecipients shall certify and disclose accordingly.

**(J) Procurement of Recovered Materials – When federal funds are expended, the District and its contractors must comply with section 6002 of the Solid Waste Disposal Act, as amended by the Resource Conservation and Recovery Act. The requirements of Section 6002 include: (1) procuring only items designated in guidelines of the Environmental Protection Agency (EPA) at 40 CFR part 247 that contain the highest percentage of recovered materials practicable, consistent with maintaining a satisfactory level of competition, where the purchase price of the item exceeds \$10,000 or the value of the quantity acquired during the preceding fiscal year exceeded \$10,000; (2) procuring solid waste management services in a manner that maximizes energy and resource recovery; and (3) establishing an affirmative procurement program for procurement of recovered materials identified in the EPA guidelines.**

Pursuant to Federal Rule (J) above, when federal funds are expended by the District, as required by the Resource Conservation and Recovery Act of 1976 (42 U.S.C. § 6962(c)(3)(A)(i)), the vendor certifies, by signing this document, that the percentage of recovered materials content for EPA-designated items to be delivered or used in the performance of the contract will be at least the amount required by the applicable contract specifications or other contractual requirements.

**(K) Domestic Preferences for Procurements – As appropriate and to the extent consistent with law, the non-Federal entity should, to the greatest extent practicable under a Federal award, provide a preference for the purchase, acquisition, or use of goods, products, or materials produced in the United States (including but not limited to iron, aluminum, steel, cement, and other manufactured products). The requirements of this section must be included in all subawards including all contracts and purchase orders for work or products under this award. For purposes of 2 CFR Part 200.322, "Produced in the United States" means, for iron and steel products, that all manufacturing processes, from the initial melting stag through the application of coatings, occurred in the United States. Moreover, for purposes of 2 CFR Part 200.322, "Manufactured products" means items and construction materials composed in whole or in part of non-ferrous metals such as aluminum, plastics and polymer-based products such as polyvinyl chloride pipe, aggregates such as concrete, glass, including optical fiber, and lumber.**

Pursuant to Federal Rule (K) above, when federal funds are expended by the District, vendor certifies, by signing this document, that to the greatest extent practicable vendor will provide a preference for the purchase, acquisition, or use of goods, products, or materials produced in the United States (including but not limited to iron, aluminum, steel, cement, and other manufactured products).

**(L) Ban on Foreign Telecommunications – Federal grant funds may not be used to purchase equipment, services, or systems that use "covered telecommunications" equipment or services as a substantial or essential component of**

**any system, or as critical technology as part of any system. “Covered telecommunications” means purchases from Huawei Technologies Company or ZTE Corporation (or any subsidiary or affiliate of such entities), and video surveillance and telecommunications equipment produced by Hytera Communications Corporation, Hangzhou Hikvision Digital Technology Company, or Dahua Technology Company (or any subsidiary or affiliate of such entities).**

Pursuant to Federal Rule (L) above, when federal funds are expended by the District, vendor certifies, by signing this document, vendor will not purchase equipment, services, or systems that use “covered telecommunications”, as defined by 2 CFR §200.216, equipment or services as a substantial or essential component of any system, or as critical technology as part of any system.

---

**RECORD RETENTION REQUIREMENTS FOR CONTRACTS INVOLVING FEDERAL FUNDS**

---

When federal funds are expended by the District for any contract resulting from this procurement process, Vendor certifies that it will comply with the record retention requirements detailed in 2 CFR § 200.333. Vendor further certifies that it will retain all records as required by 2 CFR § 200.333 for a period of three years after grantees or subgrantees submit final expenditure reports or quarterly or annual financial reports, as applicable, and all other pending matters are closed.

---

**CERTIFICATION OF COMPLIANCE WITH THE ENERGY POLICY AND CONSERVATION ACT**

---

When the District expends federal funds for any contract resulting from this procurement process, Vendor certifies that it will comply with the mandatory standards and policies relating to energy efficiency which are contained in the state energy conservation plan issued in compliance with the Energy Policy and Conservation Act (42 U.S.C. 6321 et seq.; 49 C.F.R. Part 18).

---

**CERTIFICATION OF EQUAL EMPLOYMENT STATEMENT**

---

It is the policy of the District not to discriminate on the basis of race, color, national origin, gender, limited English proficiency or handicapping conditions in its programs. Vendor agrees not to discriminate against any employee or applicant for employment to be employed in the performance of this Contract, with respect to hire, tenure, terms, conditions and privileges of employment, or a matter directly or indirectly related to employment, because of age (except where based on a bona fide occupational qualification), sex (except where based on a bona fide occupational qualification) or race, color, religion, national origin, or ancestry. Vendor further agrees that every subcontract entered into for the performance of this Contract shall contain a provision requiring non-discrimination in employment herein specified, binding upon each subcontractor. Breach of this covenant may be regarded as a material breach of the Contract.

---

**CERTIFICATION OF COMPLIANCE WITH BUY AMERICA PROVISIONS**

---

*[Only Applicable to Contracts funded under the National School Lunch Program]* The Buy American regulations promulgated by USDA and TDA require public school districts to purchase domestically grown and processed food to the maximum extent practicable. The food product must consist of agricultural commodities that were grown domestically, unless an authorized exception exists and has been approved by the District.

---

---

**CERTIFICATION OF ACCESS TO RECORDS – 2 C.F.R. § 200.336**

---

---

Vendor agrees that the District's Inspector General or any of their duly authorized representatives shall have access to any books, documents, papers and records of Vendor that are directly pertinent to Vendor's discharge of its obligations under the Contract for the purpose of making audits, examinations, excerpts, and transcriptions. The right also includes timely and reasonable access to Vendor's personnel for the purpose of interview and discussion relating to such documents.

---

---

**CERTIFICATION OF APPLICABILITY TO SUBCONTRACTRS**

---

---

Vendor agrees that all contracts it awards pursuant to the Contract shall be bound by the foregoing terms and conditions.

---

**VENDOR AGREES TO COMPLY WITH ALL APPLICABLE FEDERAL, STATE, AND LOCAL LAWS, RULES, REGULATIONS, AND ORDINANCES. IT IS FURTHER ACKNOWLEDGED THAT VENDOR CERTIFIES COMPLIANCE WITH ALL PROVISIONS, LAWS, ACTS, REGULATIONS, ETC. AS SPECIFICALLY NOTED ABOVE.**

Vendor's Name: \_\_\_\_\_

Address, City, State, and Zip Code: \_\_\_\_\_

Phone Number: \_\_\_\_\_ Fax Number: \_\_\_\_\_

Printed Name and Title of Authorized Representative: \_\_\_\_\_

Email Address: \_\_\_\_\_

Signature of Authorized Representative: \_\_\_\_\_

Date: \_\_\_\_\_

**Confidential Student Information Agreement  
Exhibit B to Specialized Services Agreement  
Between  
Harris County Department of Education, and the Fort Bend Independent School District**

On behalf of \_\_\_\_\_, Inc., (“Contractor”), I acknowledge that in the course of our work for the Fort Bend Independent School District (“School District”), Contractor may have access to individual student information. The Confidential Student Information Agreement sets forth Contractor’s work for the District in providing specialized services for students with disabilities, particularly those related to mental health and behavior problems to serve the District’s educational needs. The work to be performed by Contractor is work performed as independent contractors of the District. Consequently, for purposes of the work to be performed for the District, Contractor is a “school official” as the term is used in FL (Local). Therefore, Contractor has a legitimate educational interest in the student information provided for the use in supporting the District’s educational needs. As such, Contractor’s access to individual student information is permitted under the Family Educational Rights and Privacy Act of 1974 (FERPA) and its implementing federal regulations found in 34 CFR Part 99.

Contractor agrees and understands that information concerning any individual student is to be held in strictest confidence and assures that procedures are in place for monitoring and protecting confidentiality of student information, including, but not limited to, tracking access by assigned passwords. All media that contain individual student records and Contractor records that contain individual student records will be kept in a secure area at the District. Each Contractor representative that will access the individual student records must agree to protect student confidentiality by signing the attached “Access Agreement.”

In addition, Contractor agrees that any data sets or output reports that its representatives may generate with individual student data are confidential. Contractor will not disclose to any unauthorized person any data sets or reports with individual student data which is obtained or devised. Contractor agrees to be responsible for any computer transactions performed as a result of access authorized by use of password(s). Contractor agrees to destroy the data when it is no longer needed for purposes of the work for which Contractor has contracted to perform for the District.

Contractor understands that any unauthorized disclosure of confidential student information is illegal as provided in FERPA and its implementing regulations. FERPA is specifically incorporated into the Texas Public Information Act as an exception to records which are subject to disclosures to the public (Texas Government Code, Chapter 552).

**Harris County Department of Education**

Signed By: \_\_\_\_\_  
Title: \_\_\_\_\_  
Printed Name: \_\_\_\_\_  
Date: \_\_\_\_\_

**EXHIBIT B**

**ACCESS AGREEMENT**

Under the terms of the Agreement between \_\_\_\_\_ (“Contractor”) and the Fort Bend Independent School District (“School District”), I am requesting access to confidential student information.

I understand that any unauthorized disclosure of confidential student information is illegal as provided in the Family Educational Rights and Privacy Act of 1974 (FERPA) and in the implementing federal regulations found at 34 CFR, Part 99. I understand that any personal characteristics of a student that could make the student's identity traceable are protected.

In addition, I understand that any data sets or output reports that I may generate using confidential data are to be protected. I will not distribute to any unauthorized person any data sets or reports that I have access to or may generate using confidential data. I will not disclose any data analysis or report to any party without the consent of the District. I understand that I am responsible for any telephone or computer transactions performed as a result of access authorized by use of sign-on/password(s).

I also understand that failure to observe these restrictions is prohibited by Texas Government Code §552.352 and FERPA.

Signed By: \_\_\_\_\_

Title: \_\_\_\_\_

Printed Name: \_\_\_\_\_

Date: \_\_\_\_\_



**EXHIBIT C**

**Contractor Certification**

**Definitions:**

*Covered employees:* Employees who have or will have continuing duties related to the service to be performed at the District and have or will have direct contact with students. The District will be the final arbiter of what constitutes direct contact with students.

*Disqualifying criminal history:* Any conviction or other criminal history information designated by the District, or one of the following offenses, if at the time of the offense, the victim was under 18 or enrolled in a public school: (a) a felony offense under Title 5, Texas Penal Code; (b) an offense for which a defendant is required to register as a sex offender under Chapter 62, Texas Code of Criminal Procedure; or (c) an equivalent offense under federal law or the laws of another state.

On behalf of \_\_\_\_\_ (“Contractor”), I certify that  
[check one]:

Contractor has no employees; Contractor provides services to the District as an individual and has or will have direct contact with students. Contractor certifies that Contractor does not have a disqualifying criminal history.

*Or*

None of Contractor’s employees are *covered employees*, as defined above. If this box is checked, I further certify that Contractor has taken precautions or imposed conditions to ensure that Contractor’s employees will not become *covered employees*. Contractor will maintain these precautions or conditions throughout the time the contracted services are provided.

*Or*

Some or all of Contractor’s employee are *covered employees*. If this box is checked, I further certify that:

1. Contractor has obtained all required criminal history record information regarding its covered employees. None of the covered employees has a disqualifying criminal history.
2. If Contractor receives information that a covered employee subsequently has a disqualifying criminal history, Contractor will immediately remove the covered employee from contract duties and notify the District in writing within 3 business days.
3. Upon request, Contractor will provide the District with the name and any other requested information of covered employees so that the District may obtain criminal history record information on the covered employees.
4. If the District objects to the assignment of a covered employee on the basis of the covered employee’s criminal history record information, Contractor agrees to discontinue using the covered employee to provide services at the District.

Noncompliance or misrepresentation regarding this certification may be grounds for contract termination.

\_\_\_\_\_  
Signature

\_\_\_\_\_  
Date

**EXHIBIT D**

<p><b>CONFLICT OF INTEREST QUESTIONNAIRE</b></p> <p><b>CIQ</b></p> <p><b>For vendor or other person doing business with local governmental entity</b></p>	<p><b>FORM</b></p>
<p>This questionnaire reflects changes made to the law by H.B. 1491, 80th Leg., Regular Session.</p> <p>This questionnaire is being filed in accordance with Chapter 176, Local Government Code by a person who has a business relationship as defined by Section 176.001(1-a) with a local governmental entity and the person meets requirements under Section 176.006(a).</p> <p>By law this questionnaire must be filed with the records administrator of the local governmental entity not later than the 7th business day after the date the person becomes aware of facts that require the statement to be filed. See Section 176.006, Local Government Code.</p> <p>A person commits an offense if the person knowingly violates Section 176.006, Local Government Code. An offense under this section is a Class C misdemeanor.</p>	<p><b>OFFICE USE ONLY</b></p> <p>Date Received</p>
<p><b>1</b> Name of person who has a business relationship with local governmental entity.</p>	
<p><b>2</b> <input type="checkbox"/> Check this box if you are filing an update to a previously filed questionnaire.</p> <p>(The law requires that you file an updated completed questionnaire with the appropriate filing authority not later than the 7th business day after the date the originally filed questionnaire becomes incomplete or inaccurate.)</p>	
<p><b>3</b> Name of local government officer with whom filer has employment or business relationship.</p> <p style="text-align: center;">_____</p> <p style="text-align: center;">Name of Officer</p> <p>This section (item 3 including subparts A, B, C &amp; D) must be completed for each officer with whom the filer has an employment or other business relationship as defined by Section 176.001(1-a), Local Government Code. Attach additional pages to this Form CIQ as necessary.</p> <p>A. Is the local government officer named in this section receiving or likely to receive taxable income, other than investment income, from the filer of the questionnaire?</p> <p style="text-align: center;"><input type="checkbox"/> Yes                      <input type="checkbox"/> No</p> <p>B. Is the filer of the questionnaire receiving or likely to receive taxable income, other than investment income, from or at the direction of the local government officer named in this section AND the taxable income is not received from the local governmental entity?</p> <p style="text-align: center;"><input type="checkbox"/> Yes                      <input type="checkbox"/> No</p> <p>C. Is the filer of this questionnaire employed by a corporation or other business entity with respect to which the local government officer serves as an officer or director, or holds an ownership of 10 percent or more?</p> <p style="text-align: center;"><input type="checkbox"/> Yes                      <input type="checkbox"/> No</p> <p>D. Describe each employment or business relationship with the local government officer named in this section.</p>	
<p>_____</p> <p>Signature of person doing business with the governmental entity</p>	<p>_____</p> <p>Date</p>

**EXHIBIT E**

**FELONY CONVICTION NOTICE**

I, the undersigned Contractor or agent for the firm named above, certify that the information concerning notification of felony convictions has been reviewed by me and the following information furnished is true to the best of my knowledge. **The Contractor must complete the following information in accordance with state law.**

*Please sign only one:*

A. My firm is a publicly-held corporation, therefore, this reporting requirement is not applicable.

Signature of Contractor \_\_\_\_\_ Date \_\_\_\_\_

**OR**

B. My firm is not owned nor operated by anyone who has been convicted of a felony.

Signature of Contractor: \_\_\_\_\_ Date: \_\_\_\_\_

**OR**

C. My firm is owned or operated by the following individual(s) who has/have been convicted of a felony.

Name of Felon(s): \_\_\_\_\_ Date: \_\_\_\_\_  
*(attach additional sheet if necessary)*

Details \_\_\_\_\_ of \_\_\_\_\_ Conviction(s): \_\_\_\_\_  
*(attach additional sheet if necessary)*

Signature of Contractor: \_\_\_\_\_ Date: \_\_\_\_\_

**EXHIBIT F**

**SUSPENSION AND DEBARMENT CERTIFICATION**

Federal Law (A-102 Common Rule and OMB Circular A-110) prohibits non-federal entities from contracting with or making subawards under covered transactions to parties that are suspended or debarred or whose principals are suspended or debarred. Covered transactions include procurement contracts for goods or services equal to or in excess of \$25,000 and all nonprocurement transactions (e.g., subawards to subrecipients).

Contractors receiving individual awards of \$25,000 or more and all subrecipients must certify that their organization and its principals are not suspended or debarred by a federal agency.

Before an award of \$25,000 or more can be made to your firm, you must certify that your organization and its principals are not suspended or debarred by a federal agency.

**I, the undersigned agent for the firm named below, certify that neither this firm nor its principals are suspended or debarred by a federal agency.**

VENDOR'S NAME: \_\_\_\_\_

Signature of Company Official: \_\_\_\_\_

Date Signed: \_\_\_\_\_

Printed name of company official signing above: \_\_\_\_\_

**EXHIBIT G**

**Relationships with Foreign Entities**

During the 85<sup>th</sup> Legislative Session (2017), the State of Texas enacted two additional requirements affecting all government contracts for goods and services.

All government contracts for goods and services signed after September 1, 2017 must include required provisions from HB 89 (Certification Regarding Israel), and language to implement SB 252 (Verification Regarding Terrorist Organizations).

Therefore, in compliance with HB 89 and SB 252 of the 85<sup>th</sup> Texas Legislative Session, Contractor agrees that:

In accordance with Texas Government Code Chapter 2252, Subchapter F, Contractor certifies that it is not a company identified on the Texas Comptroller’s list of companies known to have contracts with, or provide supplies or services to, the Government of Iran, the Government of Sudan, or a foreign organization designated as a Foreign Terrorist Organization by the U.S. Secretary of State.

Contractor further certifies and verifies that, pursuant to Texas Government Code Chapter 2270, neither Contractor, nor any affiliate, subsidiary, or parent company of Contractor, if any (the “Contractor Companies”), boycotts Israel, and Contractor agrees that Contractor and Contractor Companies will not boycott Israel during the term of Agreement with Fort Bend ISD.

---

Name of Vendor (“Contractor”)

---

Mailing Address

City

State

Zip

---

Prepared by

Title

---

Signature

Date

## Addendum to Agreement for Services

**EXHIBIT H****FBISD Data Protection Addendum (v3.1)****1. Definitions.**

- a. "Agreement" is defined in the attached agreement between the District and Contractor for software and/or software related services ("Services"), and includes the terms of the attached agreement and this Data Protection Addendum.
- b. "District Data" includes all Personally Identifiable Information and other information that is not intentionally made generally available by the District on public websites or publications, including but not limited to business, administrative and financial data, intellectual property, and student and personnel data and metadata.
- c. "District De-identified Data" means any de-identified, aggregated, or otherwise anonymized data derived from "District Data" from which all Personally Identifiable Information (PII) has been removed such that the identity of individual Staff, Teachers, Students, etc. cannot be determined, and re-identification of District individuals is not possible. The data de-identification procedures and samples of subsequently de-identified District Data (provided for review to ensure efficacy of the de-identification process) must be shared prior to any usage of District De-Identified Data, in any manner. Usage of District De-identified Data requires agreement to these terms in full and prior authorization after the District's review of the de-identified data sample.
- d. "End User" means the individuals authorized by the District to access and use the Services provided by the Contractor under this Agreement.
- e. "Personally Identifiable Information" (or PII) includes but is not limited to: personal identifiers such as name, address, phone number, date of birth, Social Security number, and student or personnel identification number; personally identifiable information contained in student education records as that term is defined in the Family Educational Rights and Privacy Act, 20 USC 1232g, as amended ("FERPA"); "personal information" as that term is defined in the Children's Online Privacy Protection Act of 1998 ("COPPA"); "personal information" as that term is defined in the Protection of Pupil Rights Amendment ("PPRA"); "personally identifiable information" as that term is defined in the Individuals with Disabilities Education Act, as amended ("IDEA"); "protected health information" as that term is defined in the Health Insurance Portability and Accountability Act, 45 CFR Part 160.103 ("HIPAA"); nonpublic personal information as that term is defined in the Gramm-Leach-Bliley Financial Modernization Act of 1999, 15 USC 6809 ("GLB"); credit and debit card numbers and/or access codes and other cardholder data and sensitive authentication data as those terms are defined in the Payment Card Industry Data Security Standards ("PCI-DSS"); other financial account numbers, access codes, driver's license numbers; and state- or federal-identification numbers such as passport, visa or state identity card numbers.
- f. "Securely Destroy" means taking actions that render data written on physical (e.g., hardcopy, microfiche, etc.) or electronic media unrecoverable by both ordinary and extraordinary means.
- g. "Security Breach" means an event in which District Data is exposed to unauthorized disclosure, access, alteration, or use.
- h. "Mining District Data" means to search through, access, or extract District Data, metadata, or information which is not necessary to accomplish the purpose(s) of this Agreement.

2. **Rights and License in and to District Data.** The Parties agree that as between them, all rights including all intellectual property rights in and to District Data shall remain the sole and exclusive property of the District, and Contractor has a limited, nonexclusive license as provided in this Agreement solely for the purpose of performing its obligations hereunder. This Agreement does not give Contractor any rights, implied or otherwise, to District Data, content, or intellectual property, except as expressly stated in the Agreement.

**3. Intellectual Property Rights/Disclosure.**

## Addendum to Agreement for Services

- a. Unless necessary to perform Contractor's obligations under this Agreement or expressly agreed by the District in writing, all goods, products, materials, documents, reports, writings, video images, photographs or papers of any nature including software or computer images prepared by Contractor (or its subcontractors) for the District under this Agreement will not be disclosed to any other person or entity.
- b. The District agrees and acknowledges that Contractor owns all rights, title and interest to any and all intellectual property associated with the software or services provided by Contractor, including but not limited to all copyright, trademark, trade name, patent, trade secret, or any other intellectual property or proprietary right, whether registered or unregistered with respect to Contractor's software and related services. Contractor represents that it has all intellectual property rights necessary to enter into and perform its obligations in the Agreement, warrants to the District that the District will have use of any intellectual property contemplated by the Agreement free and clear of claims of any nature by any third Party including, without limitation, copyright or patent infringement claims, and agrees to indemnify the District for any related claims.
- c. Notwithstanding the foregoing, for grant collaboration pursuant to subcontracts under sponsored grants, intellectual property rights will be governed by the terms of the grant or contract to the District to the extent such grant or contract requires intellectual property terms to apply to subcontractors.

### 4. Data Privacy.

- a. Contractor will use District Data only for the purpose of fulfilling its duties under this Agreement and will not share District Data with or disclose it to any third Party without the prior written consent of the District, except as required by law.
- b. District Personally Identifiable Information will not be stored outside the United States without prior written consent from the District.
- c. Contractor will provide access to District Data only to its employees and subcontractors who need to access the data to fulfill Contractor's obligations under this Agreement. Contractor will ensure that employees and subcontractors who perform work under this Agreement have read, understood, and received appropriate instruction as to how to comply with the data protection provisions of this Agreement. If Contractor will have access to "education records" for the District's students as defined under FERPA, the Contractor acknowledges that for the purposes of this Agreement it will be designated as a "school official" with "legitimate educational interests" in the District Education records, as those terms have been defined under FERPA and its implementing regulations, and the Contractor agrees to abide by the FERPA limitations and requirements imposed on school officials. The Parties agree that: (1) the Services/functions to be provided by Contractor are Services/functions for which the District would otherwise use its own employees; (2) Contractor is under the District's direct control with respect to Contractor's access to and use of the education records; and (3) Contractor is subject to the requirements of 34 C.F.R. 99.33(a) with respect to Contractor's access to and use of the education records. Contractor will use the education records only for the purpose of fulfilling its duties under this Agreement for District's and its End User's benefit, and will not share such data with or disclose it to any third Party except as provided for in this Agreement, required by law, or authorized in writing by the District.
- d. Except as provided in this subsection, Contractor will use District Data only for the purpose of fulfilling its duties under this Agreement.
  - i. Contractor may not use or sell District Data
    1. to market or advertise to students, families/guardians, or District employees;
    2. to inform, influence, or enable marketing, advertising, or other commercial efforts by Contractor or a third party;
 for any commercial purpose other than fulfilling its duties under this Agreement.
  - ii. Contractor may use District De-identified Data only for the purposes of development, research, and product improvement. Data shall be considered "de-identified" when PII is

3.

## Addendum to Agreement for Services

removed, an individual record cannot be linked back to the original record, and there is no reasonable basis to believe that the remaining information in the records can be used to identify an individual.

- iii.  *[Check if Applicable]* Contractor requests approval to use District De-identified Data for limited marketing purposes. If approved, Contractor may utilize such data for the Limited Marketing Purpose identified below. Such data shall be aggregated with data from other districts or clients, and in no event may the de-identified/aggregated data be identified or identifiable as data from the District.

Limited Marketing Purpose:

Authorized District Approval: \_\_\_\_\_

- e. Contractor agrees to assist District in maintaining the privacy of District Data as may be required by State and Federal law, including but not limited to FERPA, PRRA, IDEA, and COPPA.
- f. Contractor is prohibited from Mining District Data for any purposes other than those agreed to by the Parties.
- g. Contractor is prohibited from using the software or Services to advertise in any form (including banner ads) to District students, parents, or employees.

### 5. Data Security.

- a. Contractor will store and process District Data in accordance with commercial best practices, including appropriate administrative, physical, and technical safeguards, to secure such data from unauthorized access, disclosure, alteration, and use. Such measures will be no less protective than those used to secure Contractor's own data of a similar type, and in no event less than reasonable in view of the type and nature of the data involved. Without limiting the foregoing, Contractor warrants that it will use industry-standard and up-to-date security tools and technologies such as anti-virus protections and intrusion detection methods in providing Services under this Agreement.

### 6. Employee and Subcontractor Qualifications.

- a. Contractor shall ensure that its employees and subcontractors who have potential access to District Data have undergone appropriate background screening, and possess all needed qualifications to comply with the terms of this agreement including but not limited to all terms relating to data and intellectual property protection.
- b. If the Contractor must under this Agreement create, obtain, transmit, use, maintain, process, or dispose of the subset of District Data known as Personally Identifiable Information or financial or business data which has been identified to the Contractor as having the potential to affect the accuracy of the District's financial statements, Contractor shall perform background checks reviewing any national criminal history record information on all employees who have potential to access such data.

### 7. Data Authenticity and Integrity. Contractor will take reasonable measures to protect District Data against deterioration or degradation of data quality and authenticity.

### 8. Security Breach.

- a. Response. Immediately upon, but in no event later than 24 hours after becoming aware of a Security Breach, or of circumstances that could have resulted in unauthorized access to or disclosure or use of District Data, Contractor will notify the District, fully investigate the incident, and cooperate fully with the District's investigation of and response to the incident. Except as otherwise required by law or law enforcement, Contractor will not provide notice of the incident directly to individuals whose Personally Identifiable Information was involved, regulatory agencies, or other entities, without prior written permission from the District.



## Addendum to Agreement for Services

- b. **Liability.** In addition to any other remedies available to the District under law or equity, Contractor will reimburse the District in full for all costs incurred by the District in investigation and remediation of any Security Breach caused in whole or in part by Contractor or subcontractors, including but not limited to providing notification to individuals whose Personally Identifiable Information was compromised and to regulatory agencies or other entities as required by law or contract; providing one year's credit monitoring to the affected individuals if the Personally Identifiable Information exposed during the breach could be used to commit financial identity theft; and the payment of legal fees, audit costs, fines, and other fees imposed against the District as a result of the Security Breach.
- c. Except in the event of Contractor's negligence, gross negligence, or willful misconduct, Contractor's total liability to the District under this Section 8 shall not exceed three times the total amount paid to Contractor under the Agreement.

### **9. Response to Legal Orders, Demands or Requests for Data.**

- a. Except as otherwise expressly prohibited by law, Contractor will:
  - i. immediately notify the District of any subpoenas, warrants, or other legal orders, demands or requests received by Contractor seeking District Data;
  - ii. reasonably consult with the District regarding Contractor's response;
  - iii. cooperate with the District's reasonable requests in connection with efforts by the District to intervene and quash or modify the legal order, demand or request; and
  - iv. upon the District's request, provide the District with a copy of its response.
- b. If the District receives a subpoena, warrant, or other legal order, demand (including a request for information pursuant to the Texas Public Information Act), or other request seeking District Data maintained by Contractor, the District will promptly provide a copy of the request to Contractor. Contractor will promptly supply the District with copies of records or information required for the District to respond, and will cooperate with the District's reasonable requests in connection with the District's response.

### **10. Data Transfer Upon Termination or Expiration.**

- a. Upon termination or expiration of this Agreement, Contractor will ensure that all District Data are securely returned or destroyed as directed by the District. Transfer to the District or a third Party designated by the District shall occur within a reasonable period of time, without significant interruption in service, and in the manner or format in which the data was provided. Contractor shall ensure that such transfer/migration uses facilities and methods that enable the District to access and use the District Data, are reasonably compatible with the relevant systems of the District or its transferee, and to the extent technologically feasible, that the District will have reasonable access to District Data during the transition. In the event that the District requests destruction of any District Data, Contractor agrees to Securely Destroy all District Data in its possession and in the possession of any subcontractors or agents to which the Contractor might have transferred District Data. The Contractor agrees to provide documentation of data destruction to the District.
- b. Contractor will promptly notify the District of impending cessation of its business and any contingency plans. This includes immediate transfer of any previously escrowed assets and data and providing the District access to Contractor's facilities as necessary to remove and destroy District-owned assets and data. Contractor shall implement its exit plan and take all necessary actions to ensure a smooth transition of service with minimal disruption to the District. Contractor will work closely with its successor to ensure a successful transition to the new equipment, with minimal downtime and effect on the District, all such work to be coordinated and performed in advance of the formal, final transition date.

### **11. Audits.**

## Addendum to Agreement for Services

- a. If the Contractor must under this Agreement create, obtain, transmit, use, maintain, process, or dispose of the subset of District Data known as Personally Identifiable Information or financial or business data which has been identified to the Contractor as having the potential to affect the accuracy of the District's financial statements, Contractor will at its expense conduct or have conducted at least annually a/an:
  - i. American Institute of CPAs Service Organization Controls (SOC) Type II audit, or other industry standard security audit which attests the Contractor's security policies, procedures and controls;
  - ii. vulnerability scan of Contractor's electronic systems and facilities that are used in any way to deliver Services under this Agreement; and
  - iii. formal penetration test of Contractor's electronic systems and facilities that are used in any way to deliver Services under this Agreement.
- b. If the Contractor at least annually does not have conducted an audit as described in (11a) the District reserves the right to perform audits of Contractor at the District's expense to ensure compliance with the terms of this Agreement. The Contractor shall reasonably cooperate in the performance of such audits. This provision applies to all agreements under which the Contractor must create, obtain, transmit, use, maintain, process, or dispose of District Data.
- c. Upon request, the Contractor will provide the District appropriate documentation of the above audits (proof) and will promptly modify its security measures as needed in order to cure any material findings uncovered as part of any audit in order to meet its obligations under this Agreement.

### **12. Compliance.**

- a. Contractor will comply with all applicable laws and industry standards in performing Services under this Agreement. Any Contractor personnel visiting the District's facilities will comply with all applicable District policies regarding access to, use of, and conduct within such facilities. The District will provide copies of such policies to Contractor upon request.
- b. Contractor warrants that any subcontractors used by Contractor to fulfill its obligations under this Agreement will be subject to and will comply with each and every term of this Data Protection Agreement in the same manner that Contractor itself is subject to the terms of this Data Protection Agreement.
- c. Contractor warrants that the service it will provide to the District is fully compliant with and will enable the District to be compliant with relevant requirements of all laws, regulation, and guidance applicable to the District and/or Contractor, including but not limited to: COPPA, FERPA, PPRA, IDEA, Americans with Disabilities Act (ADA), as amended, and Federal Export Administration Regulations.

**13. No End User Agreements.** This Agreement is the entire agreement between the District (including District employees and other End Users) and the Contractor regarding Contractor's access to, use of, and disclosure of District Data. In the event that the Contractor enters into terms of use agreements or other agreements or understandings, whether electronic, click-through, verbal or in writing, with District employees or other End Users, such agreements, to the extent the provisions conflict with this Agreement, shall be without effect, and the terms of this Agreement shall control.

### **14. Term and Termination.**

- a. Term. This Agreement will become effective when the Contractor accepts the Agreement. It will continue in effect until all obligations of the Parties have been met, unless terminated as provided in this Section. In addition, certain provisions and requirements of this Agreement will survive its expiration or other termination in accordance with Section 16 herein.

Addendum to Agreement for Services

- b. Termination by the District. The District may immediately terminate the Agreement if the District makes the determination that the Contractor has breached a material term of this Data Protection Agreement.
- c. Automatic Termination. This Agreement will automatically terminate without any further action of the Parties upon the termination or expiration of the Agreement between the Parties.

**15. Survival.** The Contractor’s obligations under Section 10 shall survive termination of this Agreement until all District Data has been returned or Securely Destroyed.

**16. Injunctive Relief.** The Parties agree that Contractor’s disclosure or use (or threat to disclose or use) any District Data in breach of this Agreement will cause immediate and irreparable harm to the District and the District shall be entitled to immediate injunctive relief against any actual or threatened violation, in addition to any of its other rights and remedies. In the event of any suit or action arising under this Agreement, Contractor consents to mandatory and exclusive jurisdiction of the courts in Fort Bend County, Texas.

**FORT BEND INDEPENDENT SCHOOL DISTRICT**

By: Diana Sayavedra  
Diana Sayavedra  
Acting Superintendent of Schools

June 21, 2021 | 10:18 AM CDT  
Date

**CONTRACTOR**

By: \_\_\_\_\_  
Signature

\_\_\_\_\_  
Date

Not Applicable \_\_\_\_\_  
Date

**Notice of Regular Business Meeting via Videoconference**  
**The Board of Trustees**  
**Fort Bend Independent School District**

July 20, 2020

---

Notice is hereby given that a Board of Trustees Regular Business Meeting will be held on Monday, July 20, 2020, beginning at 6:00 PM. The meeting will be held by videoconference and members of the public may listen to the meeting's audio stream at the following address: <https://www.fortbendisd.com/july20meeting>. Members of the public may register to address the Board at the following address: <https://www.fortbendisd.com/cms/lib/TX01917858/Centricity/Domain/83/Address%20BoT%20Regular%20Mtg%20Form%2008.13.18.pdf>.

Requests to address the Board must be submitted by 4:30 p.m. Members of the public who have registered to address the Board during the meeting will be provided with a separate dial-in number. The agenda packet for the meeting can be found here:

<https://v3.boardbook.org/Public/PublicHome.aspx?ak=888888>.

1. Call to order at 6:00 PM with announcement by the chair as to the presence of a quorum, that the meeting has been duly called and that notice of the meeting has been posted for the time and manner required by law
2. Pledge of Allegiance
3. Invocation
4. Recognitions
5. Audience Items
6. Information
  - A. Board Governance
    1. Update on Response to COVID-19 Pandemic
    2. COVID-19 Procurement Update
7. Convene in closed session under Texas Open Meetings Act, Texas Government Code, Chapter 551 under the following sections: 551.071 - For the purpose of a private consultation with the Board's attorney on any or all subjects or matters authorized by law; Section 551.072 - Consider purchase, exchange, lease, or value of real property, Section 551.074 - Personnel matters, Section 551.076 - Security matters, Section 551.082 - Student discipline matter or complaint, or Section 551.0821 - Personally identifiable information about public school student
8. Reconvene in Open Session
9. Consider Action on Closed Session Items
10. Board Governance
  - A. Consider Approval of Creating a Board Equity Committee, District Equity Oversight Committee, a Board Development Plan on Equity, and a District Equity Audit
11. Board Members' Report
  - A. Activity Report
  - B. Special Reports

1. Go Public Gulf Coast

12. Consent Agenda

*All items under the Consent Agenda are acted upon by one motion. Upon a Board Member's request, any item on the Consent Agenda shall be moved to the Action portion of the regular agenda.*

A. Board Governance

1. Consider Approval of Previous Meeting Minutes

- a. June 8, 2020: Public Budget Hearing
- b. June 8, 2020: Called Meeting and Agenda Review
- c. June 15, 2020: Regular Business Meeting

B. Board Goal 1: Fort Bend ISD will provide an equitable learning environment that provides all students access to the FBISD curriculum

- 1. Consider Approval of Residential and Non-Public Day School Providers
- 2. Consider Approval of a Purchase Exceeding \$50,000: Specifically for:
  - a. Consider Approval of the Purchase of Professional Learning Consulting Services

C. Scalable Systems

1. Consider Approval of Purchases Exceeding \$50,000: Specifically for:

- a. Consider Approval of the Purchase of Temporary Clerical Staff Services
- b. Consider Approval of the Purchase of an Applicant Tracking System
- c. Consider Approval of the Purchase of Printer Equipment and Printer Management Services
- d. Consider Approval of the Purchase of Global Positioning Systems for the District's White and Yellow Fleets
- e. Consider Approval of the Purchase of Lighting, Energy Saving Products, and Related Items
- f. Consider Approval of the Purchase of OEM Kitchen Equipment Parts, Preventative Maintenance, Repairs, and Related Items

13. Action

A. Board Governance

- 1. Consider Endorsement of a Candidate to Represent Region IV, Position B, as a Director on the Texas Association of School Boards, Board of Directors

B. Board Goal 1: Fort Bend ISD will provide an equitable learning environment that provides all students access to the FBISD curriculum

- 1. Consider Approval of Revisions to the 2020-21 School Year Calendar

14. Review Future Board Meeting Agenda Items

15. Adjournment

---

*If, during the course of the meeting, discussion of any item on the agenda should be held in a closed meeting, the board will conduct a closed meeting in accordance with the Texas Open Meetings Act, Government Code, Chapter 551, Subchapters D and E or Texas Government Code section 418.183(f). Before any closed meeting is convened, the presiding officer will publicly identify the section or sections of the Act authorizing the closed meeting. All final votes, actions, or decisions will be taken in open meeting. [See BEC (LEGAL)]*

The following Fort Bend ISD Goals may be referenced in agenda items included in this document:

- Goal 1: Fort Bend ISD will provide an equitable learning environment that provides all students access to the FBISD curriculum.
- Goal 2: Fort Bend ISD will ensure students own and are responsible for their learning, behavior, and progress through the FBISD curriculum.
- Goal 3: Fort Bend ISD will provide an inclusive, collaborative, and fluid learning environment with opportunities for both risk-taking and success.
- Goal 4: Fort Bend ISD will develop students' social-emotional, academic, literacy, language, and life skills in a robust Collaborative Community at every school.
- Goal 5: Fort Bend ISD will develop an organizational culture that embraces care, respect, safety, and inclusion.

**For: Fort Bend ISD Board of Trustees**  
**Date: July 20, 2020**  
**Action: Consideration and Approval:**  
**Residential and Non-Public Day**  
**Schools**  
**References: Board Policy CH (Legal)**  
**District Strategic Plan Goal 1**  
**Department: Special Education**

### **Recommendation**

Consideration and possible approval to authorize the Superintendent, or his designee, to execute agreements with the authorized residential and day treatment service providers listed in the table below as needed for the 2020-21 school year.

<b>Residential Treatment Service Providers</b>	<b>Day Treatment Service Providers</b>
Avondale House	Avondale House
Bayes Achievement Center	Shiloh Treatment Center, Inc.
Shiloh Treatment Center, Inc.	Providence Treatment Center
Devereux Foundation-Victoria	River Oaks Academy
The Texas Hill Country School	Texana Children's Center for Autism
Whispering Hills Achievement Center	Harris County Department of Education

The approval of this recommendation will allow the District to respond to the immediate needs of students who require such services in FY 21.

### **Summary**

Each year, districts are required, under federal guidelines, to set aside 25% of IDEA funds for residential and non-public day school services. Student placement in a residential or day treatment setting occurs at the recommendation of the Admission, Review and Dismissal Committee after all other resources for Special Education services within the District have been exhausted.

The set aside amount for 2020-21 at the required percentage for the District is \$3,112,415. In 2019-20, the District contracted for services for students in such facilities for approximately \$2,382,723. Based upon history, the District does not anticipate expending the total amount but is required to set the money aside for student situations not anticipated.

Recommended by:

Charles E. Dupre  
Superintendent of Schools

Submitted by:

Beth Martinez  
Chief Academic Officer



**Regular Board Meeting**

**8.D.6.**

**Meeting Date:** July 21, 2021  
**Title:** Schools Division ABS West-Contract Addendum FY21 for ESY Summer School: Houston ISD (3)  
**Submitted For:** Charles Ned, Schools  
**Submitted By:** Denise Alamos  
**Recommended Action:** Approve  
**HCDE Goal(s):** 1. Impact education/respond to evolving needs  
**Additional Resource Personnel:** Jonathan Parker, Charles Ned, Dr. Jesus Amezcua, Kendra Jackson  
**Facilities/Technology Approval Needed?:**

**Information**

**Posted Agenda Item:**

**Approval of Addendum #1 to Interlocal (revenue) contract between Academic and Behavior School West and Houston ISD** to increase the aggregate amount from \$412,100 to \$427,934 (an increase of \$15,834) for three (3) additional units for FY 2021 Extended School Year Services (ESY) Summer School (in-county \$5,278) for the time period of 06/14/2021 through 07/16/2021.

**Subject:**

Addendum #1 to Interlocal (revenue) contract between Academic and Behavior School West and **Houston ISD** to increase the aggregate amount from \$412,100 to \$427,934 (an increase of \$15,834) for three (3) additional units for FY 2021 Extended School Year Services (ESY) Summer School (in-county \$5,278) for the time period of 06/14/2021 through 07/16/2021.

**Rationale:**

Entity	Description	Dates	Total
Houston ISD	Summer School Contract-ESY Addendum (in-county \$5,278 each) x 3 units =\$15,834 Increase	6/14/21-7/16/21	\$427,934
Total:			\$427,934

**Fiscal Impact**

**Included in FY budget Y/N:** Y  
**Included in current budget amendment Y/N:** N

**Attachments**

FY21 ABSW-ESY Addendum Houston ISD-3\_Increase by\$15,834

**Form Review**

Inbox	Reviewed By	Date
Purchasing	Kendra Jackson	07/06/2021 01:02 PM
Assistant Superintendent - Business	Jesus Amezcua	07/09/2021 03:54 PM
Form Started By: Denise Alamos		Started On: 06/28/2021 03:26 PM
Final Approval Date: 07/09/2021		

**FIRST ADDENDUM TO THE AGREEMENT  
BETWEEN  
THE HOUSTON INDEPENDENT SCHOOL DISTRICT  
AND  
HARRIS COUNTY DEPARTMENT OF EDUCATION ABS WEST (ESY)**

This First Addendum modifies the original agreement between the Houston Independent School District and Harris County Department of Education ABS East which was previously approved and executed on **August 24, 2020**. This addendum adds ESY (Extended School Year) services for **Jayden R., Andrew E. and Collins J.** The modifications to the original Agreement are contained below and are identified by paragraph numbers. The remainder of the Agreement remains in effect and is not affected by these changes.

1. This addendum is to increase the amount of the original contract by \$15,834.00 for services beginning June 14, 2021 through July 15, 2021.
2. The School district will pay the Contractor for its complete and satisfactory performance of this Agreement Four Hundred Twenty-Seven Thousand Nine Hundred Twenty-Four Dollars and Zero Cents (\$427,934.00) should not exceed Four Hundred Twenty-Seven Thousand Nine Hundred Twenty-Four Dollars and Zero Cents (\$427,934.00).

Dated this 9<sup>th</sup> day of June 2021.

Harris County Department of  
Education (West)

HOUSTON INDEPENDENT SCHOOL  
DISTRICT

\_\_\_\_\_  
Dr. James Colbert, Jr.  
County School Superintendent

\_\_\_\_\_  
Sherrie Robinson  
Controller

Approved as to Form:

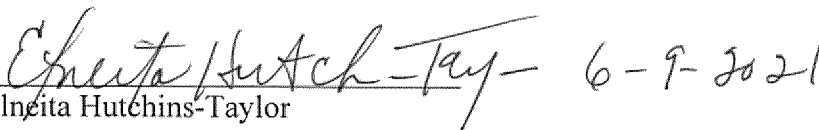
  
\_\_\_\_\_  
Elneta Hutchins-Taylor  
General Counsel

**Regular Board Meeting**

**8.D.7.**

**Meeting Date:** July 21, 2021

**Title:** Service Agreement (Expenditure) with Social Motion Inc. for CASE for Kids County Connections Youth Summer Initiative

**Submitted For:** Lisa Caruthers, Case for Kids

**Submitted By:** Kimberlee Flowers

**Recommended Action:** Approve

**HCDE Goal(s):**  
1. Impact education/respond to evolving needs  
2. Deliver value responsibly  
3. Advocate for learners through innovation

**Additional Resource Personnel:** Danielle Bartz, Dr. Lisa Caruthers, Dr. Jesus Amezcua, Bill Monroe, Kendra Jackson

**Facilities/Technology Approval Needed?:**

**Information**

**Posted Agenda Item:**

**Ratification of award RFP#21/044KJ for County Connections-Youth Summer Initiative and Approve aggregate expenditures of \$55,000 from CASE for Kids to Social Motion Inc.:** County Connections’ grant award (Expenditure Contracts) totaling \$20,000 for Social Motion Inc. for Summer 2021 programming is in addition to prior awards of \$20,000 in Partnership Project funding, and a prior award of \$15,000 in City Connections funding for a total aggregate amount of \$55,000. County Connections will increase number of students served, number of sites served and/or timeframe in which students are served.

**Subject:**

Service Agreement (Expenditure) with Social Motion Inc. for CASE for Kids County Connections-Youth Summer Initiative.

**Rationale:**

County Connections Youth Summer Initiative 2021, funded directly by Harris County, supports nonprofit organizations that address the need for youth services during the summer. Initiatives funded by the CASE for Kids County Connections program can provide comprehensive summer programs, short term projects and summer camps hosted in-person or virtually from a variety of locations including schools, community centers, apartment complexes and churches. Initiatives are customized to meet community needs of individual Harris County Precincts. Services must include resources or reduce cost for summer initiatives for families during pandemic conditions.

Social Motion Inc will receive \$20,000 in funding to serve 69 students in Precinct 3. This service agreement is in addition to a prior Partnership Project grant award for \$20,000 to serve 45 students at Social Motion Inc. and a prior City Connections award for \$15,000 to serve 99 students at Social Motion Inc. and the Success on the Spectrum Center in City Council Districts A and D for an aggregate amount of \$55,000 in awards from CASE for Kids.

**Fiscal Impact**

**Attachments**

SOCIAL MOTION

\*\*\*\*\*NOTICE OF GRANT AWARD\*\*\*\*\*

Project Title: CASE for Kids County Connections Youth Summer Initiative 2021  
Grant Term: June 14, 2021 – August 15, 2021  
Center for Afterschool, Summer, and Enrichment for Kids (CASE for Kids)  
Harris County Department of Education

\*\*\*\*\*

Social Motion Inc.  
Emily Smart  
1450 W Sam Houston Pkwy N Building 2 Ste G, Houston, TX 77043

Dear Social Motion Inc.,

The Harris County Department of Education (“HCDE”) hereby awards a grant in the amount of \$20,000 to Social Motion Inc. (“Grantee”) in support of the above-referenced project. This award is subject to the terms and conditions specified herein (the “NOGA”) and in HCDE’s CASE for Kids County Connections Request for Proposals (“RFP”). Acceptance of this award, including the terms and conditions detailed in this NOGA, is acknowledged by the Grantee by returning (1) one signed original to HCDE CASE for Kids, no later than June 11, 2021.

In consideration of the mutual covenants and conditions contained in this Notice of Grant Award (“NOGA”) and other good and valuable consideration, the receipt and sufficiency of which are hereby acknowledged, the parties, intending to be legally bound, agree as follows:

**Program Description**

*Our proposed County Connections initiative is afterschool social skills classes that are dedicated to providing techniques and social skills training for children from kindergarten - 12th grade who have autism and similar special needs. Providing techniques and social skills training that target deficits manifesting in behavioral and emotional immaturity. In class, our teachers introduce the skill, give a rational, model the behavior, and provide feedback. Each class focuses on teaching emotional regulation skills such as recognizing other's emotions, recognizing their own emotions and using emotions vocabulary. All classes offer skill training and lesson plans based on evidence-based strategies.*

CASE for Kids County Connections Site(s): **Social Motion Inc.**

**Term**

Grantee must start programming on or after June 14, 2021 and end programming no later than August 15, 2021. Your grant application proposed the dates and times described on the CASE for Kids County Connections Proposed Site List. Changes to program dates or times must be submitted in writing to HCDE’s CASE division and approved by CASE in advance.

## Compensation

Upon return of (1) one signed original of the Notice of Grant Award, Grantee must submit an invoice for 80% of the grant award for payment. The final 20% of the grant award will be paid upon receipt and approval of an invoice, documentation of expenditures, and the final report as outlined below.

Grantee shall match the total amount of program grant funding on a dollar-for-dollar basis. The match may be cash or in-kind support from other sources. Grantee shall maintain sufficient documentation of its match and produce said documentation to HCDE upon request.

Grantee agrees to expend grant funding to support the proposed project, as described, to provide service for the Harris County Precinct and its constituents.

Grantee is required to submit original invoices to the HCDE Business Office ATTN: Accounts Payable. The invoices can be mailed through the postal service to HCDE Business Office ATTN: Accounts Payable 6300 Irvington Boulevard Houston, Texas 77022 or emailed to [accountspayable@hcde-texas.org](mailto:accountspayable@hcde-texas.org).

The invoice should include the following:

1. Date of invoice
2. Period of service (i.e. month of)
3. Invoice Number
4. Contact Information
5. Deliverables under the contract: CASE for Kids County Connections 2021
6. Certification of service provided through a signature by company representative.

Budget Period 2020-2021	
Project Administration	\$1,576.28
Program Quality Improvement	\$
Payroll & Staff	\$18,423.72
Professional Service	\$
Supplies and Materials	\$
Events	\$
Buses/Mileage	\$
Scholarship/Discounted Fees	
Miscellaneous	\$
<b>Total Budget: \$20,000</b>	

## Grantee's Requirements

1. Grant recipients must meet the following requirements, according to the schedule and deadlines set by HCDE:
  - a. Grantees shall maintain all records and accounts in a manner that shall assure full accounting of all expenditures paid for with both funds received from HCDE and local site matching funds relating to the signed Notice of Grant Award (NOGA). Grantee records and accounts shall be retained by the grantee and made available

for audit by HCDE, Harris County, or their respective representatives for a period of not less than three (3) years after the expiration or termination of the NOGA. If an audit has been announced, the grantee shall retain its records and accounts until such audit has been completed.

- b. Grantee shall comply with all applicable federal, state, and municipal laws, ordinances, rules, and regulations and certify such compliance upon request.
  - c. Complete a final report at the end of the program period, including but not limited to attendance forms and a project summary form provided by CASE for Kids detailing project accomplishments and challenges, photo documentation of the project, and promotional materials.
  - d. Submit attendance and demographics for youth served with program grant funding, in the manner required by HCDE.
  - e. Comply with evaluations required by HCDE, which may include site visits, focus groups, and surveys.
  - f. Agree to obtain and assess criminal history record information for each employee, contractor, or volunteer used in the delivery of projects funded by program grant funds and to use only those persons fit to work with students.
  - g. Submit an HCDE vendor packet to include, at a minimum, the following: W-9 Form, Conflict of Interest Form, Felony Conviction Affidavit Form, and Covered Employee Affidavit Form.
  - h. Staff members of the funded organization are eligible to attend the CASE for Kids free Afterschool Community Training Series.
  - i. Awarded organizations are required to attend two (2) mandatory meetings presented by CASE for Kids staff during the grant term on topics related to grant compliance, funding and resources on program implementation. The mandatory workshop schedule and details will be emailed to grantees.
  - j. Provides a safe and inclusive environment for youth. See details on [www.hcde-texas.org/afterschoolzone](http://www.hcde-texas.org/afterschoolzone).
2. Grantee agrees to meet CASE for Kids quality framework: element one- safe and inclusive environment and element four- collaborative relationships.

### **Program Promotion**

All promotional material or press releases for the project must include the following:

County Connections is funded in part by Harris County, and administrated by Harris County Department of Education via CASE for Kids.

Promotional materials or press releases for the project must not include:

Logos for Harris County, CASE for Kids, and Harris County Department of Education may not be used in program promotion.

### **Program Compliance & Documentation**

Grantee must adhere to all of the following requirements.

1. Final Report Form – Grantee must provide a final report form that will include a narrative that will highlight the work of the program, challenges, and overall outcome of the program. The final report must also demonstrate how the grantee enhanced program quality during the grant period, as well as provide supporting documentation. Final Report Forms must be submitted to the CASE office, 6005 Westview, Houston, TX 77055 no later than 15 days after the August 15, 2021. To conserve paper, final report and supporting documentation must be submitted items on a flash drive. Files must be in PC format.
2. Student Data Impact- Grantee must utilize the database provided by HCDE to complete attendance information, unless otherwise instructed by CASE for Kids. Grantee will also obtain demographic information through a student registration form that will be provided through the CASE for Kids County Connections Registration Form or approved grantee organization registration form.
3. Proof of expenditures – All expenditures for the awarded amount must be documented.
  - a. Copies of original receipts for expenditures, proof of payroll/professional services, and all other expenses. (Original receipts may be requested upon review of the final report.)
4. Images from project– Eight (8) digital images of the project. Images must be submitted on a USB flash drive in JPG format.
5. Promotional materials – Any materials utilized to promote the County Connections project that include or mention Harris County, CASE for Kids and Harris County Department of Education. Include examples of all promotional materials (press releases, flyers, brochures, etc.).

### **Evaluation**

Grantee may be asked to participate in a more in-depth evaluation of funding impact, which may include site visits, focus groups, and surveys. If selected for this evaluation, Grantee agrees to work with HCDE’s Division of Research and Evaluation to ensure the completion of post-project assessments.

Grantee must have an evaluation participation release form signed by a parent/guardian for each student who completes a project survey.

### **Language Assistance**

Grantee must acknowledge, in a form acceptable to HCDE where required by HCDE in a non-discriminatory manner, that it can provide reasonable assistance to non-English speaking participants in its Activity.

### **Insurance**

Grantees must provide proof of insurance, in no less than the amounts detailed in Exhibit "B" attached hereto and made a part hereof.

### **Termination**

If services are not delivered as detailed in this NOGA, the RFP, and/or Grantee's application/proposal, if Grantee does not timely submit a complete final report, if final evaluation by CASE for Kids results in concern over implementation of the project, or if Grantee does not submit evaluation pre/post assessments, the final 20% of the grant award will not be allocated, and Grantee may be required to return part or all of the previously allocated grant funding. Additionally, if Grantee does not adequately document proof of expenses, Grantee may be required to return all or a portion of the grant amount.

### **Indemnity**

**TO THE MAXIMUM EXTENT AUTHORIZED UNDER THE CONSTITUTION AND LAWS OF THE STATE OF TEXAS, GRANTEE WILL HOLD HCDE, ITS OFFICERS, AGENTS, AND EMPLOYEES HARMLESS FROM ANY AND ALL CLAIMS, DEMANDS, DAMAGES, LIABILITIES, AND COSTS WHICH RESULT FROM ANY WILLFUL MISCONDUCT OR NEGLIGENT ACT OR OMISSION OF GRANTEE, ITS OFFICERS, AGENTS, OR EMPLOYEES, PERTAINING TO ITS ACTIVITIES AND OBLIGATIONS UNDER THIS NOGA OR RELATED TO THE COUNTY CONNECTIONS PROGRAM.**

### **Non-Appropriation of Funds**

The term of this NOGA is a commitment of HCDE current revenue only. Notwithstanding anything to the contrary in this NOGA, HCDE's obligation to pay grant funds as stated herein is expressly contingent upon HCDE receiving local, state, and/or federal funds ("funds") for after-school and out-of-school activities that are sufficient to satisfy all obligations to other grantees with which HCDE contracts to provide County Connections projects. In the event HCDE does not receive those funds or sufficient funds, HCDE may terminate this NOGA and will not be responsible for paying Grantee the amount specified herein or for any of the costs of the County Connections program(s) provided by Grantee.

### **Governing Law & Venue**

This NOGA shall be governed by and construed in accordance with the laws of the State of Texas, without regard to its conflicts of laws principles. The mandatory and exclusive venue for



the adjudication or resolution of any dispute arising out of this NOGA or the County Connections project shall be in Harris County, Texas, and the parties hereby submit to the exclusive jurisdiction of said courts.

**Assignment**

Neither this NOGA nor any duties or obligations outlined in this NOGA shall be assignable by Grantee without the prior written consent of HCDE.

**Relationship**

It is understood and agreed that Grantee is an independent contractor. Nothing in this NOGA shall be interpreted or construed as creating or establishing the relationship of employer and employee between HCDE and any employee or agent of Grantee. The NOGA does not create a joint venture or business partnership under Texas law.

Grantee is solely responsible for the supervision, daily direction and control, payment of salary (including withholding of income taxes and social security), insurance, worker's compensation, and disability benefits and like requirements and obligations of Grantee's employees, agents, volunteers, and representatives.

**Amendment; Entire Agreement**

This NOGA may be amended only by the mutual agreement of the parties, in writing, to be attached to and incorporated in this NOGA.

This Notice of Grant Award ("NOGA"), HCDE's CASE for Kids County Connections Request for Proposals ("RFP"), and Grantee's proposal/application submitted in response to HCDE's RFP, and the attached and incorporated addendum or exhibits, if any, contain the entire agreement of the parties relative to the purpose(s) of the agreement and supercede any other representations, agreements, arrangements, negotiations, or understanding, oral or written, between the parties to this NOGA. In the event of a conflict between this NOGA and the RFP or Grantee's proposal/application submitted in response to the RFP, this NOGA shall control. In the event of a conflict between the RFP and Grantee's proposal/application submitted in response to the RFP, the RFP shall control.

Neither this NOGA, nor any term or provision hereof, nor any inclusion by reference, shall be construed as being for the benefit of any party not in signatory hereto.

Social Motion Inc.

By: *Emily Smart*  
Emily Smart (Jun 11, 2021 06:00 CDT)

(Signature)

Emily Smart  
1450 W Sam Houston Pkwy N Building 2  
Ste G, Houston, TX 77043  
Phone: 713461-7200  
Email: [esmart@socialmotionskills.org](mailto:esmart@socialmotionskills.org)

Harris County Department of Education

By: \_\_\_\_\_

(Signature)

Dr. Jesus Amezcua  
Assistant Superintendent, Business  
6300 Irvington Blvd.  
Houston, TX 77022-5618  
Phone: 713-696-8249 Fax: 713-696-0740  
Email: [jamezcua@hcde-texas.org](mailto:jamezcua@hcde-texas.org)

## Exhibit B

### GRANTEE INSURANCE REQUIREMENTS

Grantee is required to provide HCDE with copies of certificates of insurance, naming HCDE as an additional insured, for Texas Workman's Compensation and General Liability Insurance. Certificates of Insurance, name and address of Grantee, the limits of liability, the effective dates of each policy, and policy number shall be delivered to HCDE prior to commencement of any work under this Agreement. The insurance company insuring Grantee shall be licensed in the State of Texas and shall be acceptable to HCDE. Grantee shall give HCDE a minimum of ten (10) days' notice prior to any modifications or cancellation of said policies of insurance. Grantee shall require all subcontractors performing any work under or relating to this Agreement to maintain coverage as specified below.

Minimum Insurance Requirements:

- Grantee shall, at all times during the Term of this Agreement, maintain insurance coverage with not less than the type and requirements shown below. Such insurance is to be provided at the sole cost of Grantee. These requirements do not establish limits of Grantees's liability.
  - All policies of insurance shall waive all rights of subrogation against HCDE, its officers, employees, and agents.
  - Upon request, certified copies of original insurance policies shall be furnished to HCDE.
  - HCDE shall be named as an "additional insured" on all insurance policies.
  - HCDE reserves the right to require additional insurance should HCDE deem additional insurance necessary, in HCDE's sole discretion.
- A. Workers' Compensation (with Waiver of subrogation to HCDE) Employer's Liability, including all states, U.S. Longshoremen, Harbor Workers and other endorsements.
- B. Statutory, and Bodily Injury by Accident: \$100,000 each employee. Bodily Injury by Disease: \$500,000, policy limit \$100,000 each employee. Commercial General Liability Occurrence Form including, but not limited to, Premises and Operations, Products Liability Broad Form Property Damage, Contractual Liability, Personal and Advertising Injury Liability and where the exposure exists, coverage for watercraft, blasting collapse, and explosions, blowout, catering and underground damage.
- \$300,000 each occurrence Limit Bodily Injury and Property Damage combined
  - \$300,000 Products-Completed Operations Aggregate Limit \$500,000 per Job Aggregate
  - \$300,000 Personal and Advertising Injury Limit
- C. Automobile Liability Coverage  
\$300,000 Combined Liability Limits Bodily Injury and Property Damage Combined

In the event the above-detailed insurance requirements require modifications after the NOGA is executed, as determined by HCDE in its sole discretion, HCDE reserves the right to amend this Exhibit B to the NOGA, with such modifications to be effective upon written notice to Grantee, and Grantee agrees to comply with such modified requirements. Grantee acknowledges and agrees that continued payment by HCDE to Grantee under the NOGA is adequate consideration for agreeing to comply with the required insurance requirements, as modified. In the event such modified requirements are required, HCDE and Grantee agree that a formal amendment to the NOGA is not required, but the modified insurance requirements shall become effective upon written notice to Grantee.

**Regular Board Meeting**

**8.D.8.**

**Meeting Date:** July 21, 2021  
**Title:** Service Agreement (Expenditure) with YMCA for CASE for Kids County Connections Youth Summer Initiative  
**Submitted For:** Lisa Caruthers, Case for Kids  
**Submitted By:** Kimberlee Flowers  
**Recommended Action:** Approve  
**HCDE Goal(s):** 1. Impact education/respond to evolving needs  
 2. Deliver value responsibly  
 3. Advocate for learners through innovation

**Additional Resource Personnel:** Danielle Bartz, Dr. Lisa Caruthers, Dr. Jesus Amezcua, Bill Monroe, Kendra Jackson  
**Facilities/Technology Approval Needed?:**

**Information**

**Posted Agenda Item:**

**Ratification of award RFP#21/044KJ for County Connections-Youth Summer Initiative and Approve aggregate expenditures of \$90,000 from CASE for Kids to the YMCA of Greater Houston:** County Connections’ grant award (Expenditure Contracts) totaling \$30,000 for YMCA of Greater Houston for summer 2021 programming is addition to prior awards of \$40,000 in Partnership Project funding and \$20,000 in City Connections funding for a total aggregate amount of \$90,000. County Connections will increase number of students served, number of sites served and/or timeframe in which students are served.

**Subject:**

Service Agreement (Expenditure) with YMCA for CASE for Kids County Connections-Youth Summer Initiative.

**Rationale:**

County Connections Youth Summer Initiative 2021, funded directly by Harris County, supports nonprofit organizations that address the need for youth services during the summer. Initiatives funded by the CASE for Kids County Connections program can provide comprehensive summer programs, short term projects and summer camps hosted in-person or virtually from a variety of locations including schools, community centers, apartment complexes and churches. Initiatives are customized to meet community needs of individual Harris County Precincts. Services must include resources or reduce cost for summer initiatives for families during pandemic conditions.

The following YMCA of Greater Houston locations will receive \$5,500 in funding for Houston Texans YMCA to serve 10 students in Precinct 1, \$13,504 in funding for Alief Family YMCA, Langham Creek Family YMCA and Trotter Family YMCA to serve a total of 30 students in Precinct 3, \$10,996 in funding for Lake Houston Family YMCA and The Womens Home to serve a total of 20 students in Precinct 4. This service agreement is in addition to a prior Partnership project grant award for \$20,000 to serve 45 students at Houston Texans YMCA and for \$20,000 to serve 45 students MD Anderson YMCA; and a prior grant award for \$20,000 for YMCA of Greater Houston through City Connections, serving 80 students in City Council Districts A and G. Services received by the entity, YMCA of Greater Houston will therefore meet the aggregate amount of \$90,000 in awards from CASE for Kids.

## Attachments

NOGA Prec1  
NOGA Prec3  
NOGA Prec4

---

### Form Review

**Inbox**

CASE  
Purchasing  
Assistant Superintendent - Business  
Form Started By: Kimberlee Flowers  
Final Approval Date: 07/09/2021

**Reviewed By**

Lisa Caruthers  
Yaritza Roman  
Jesus Amezcua

**Date**

06/28/2021 06:12 PM  
07/07/2021 04:34 PM  
07/09/2021 03:54 PM  
Started On: 06/28/2021 02:50 PM

\*\*\*\*\*NOTICE OF GRANT AWARD\*\*\*\*\*

Project Title: CASE for Kids County Connections Youth Summer Initiative 2021  
Grant Term: June 14, 2021 – August 15, 2021  
Center for Afterschool, Summer, and Enrichment for Kids (CASE for Kids)  
Harris County Department of Education

\*\*\*\*\*

YMCA of Greater Houston  
Stephen Ives  
1331 Augusta Drive, Houston, TX 77057

Dear YMCA of Greater Houston,

The Harris County Department of Education (“HCDE”) hereby awards a grant in the amount of \$5,500 to YMCA of Greater Houston (“Grantee”) in support of the above-referenced project. This award is subject to the terms and conditions specified herein (the “NOGA”) and in HCDE’s CASE for Kids County Connections Request for Proposals (“RFP”). Acceptance of this award, including the terms and conditions detailed in this NOGA, is acknowledged by the Grantee by returning (1) one signed original to HCDE CASE for Kids, no later than June 11, 2021.

In consideration of the mutual covenants and conditions contained in this Notice of Grant Award (“NOGA”) and other good and valuable consideration, the receipt and sufficiency of which are hereby acknowledged, the parties, intending to be legally bound, agree as follows:

**Program Description**

*(YMCA Houston) mission is to put Judeo-Christian principles into practice through programs that build healthy spirit, mind, and body for all. The funded project will seek to hire new specialized YMCA Youth Counselors (Youth Development Counselor for Young People with Disabilities - YDCYPD) at each of the two YMCA locations noted. The YMCA Inclusion Team and YMCA Day Camp will work with parents and young people to ensure that all required and requested accommodations are provided to deliver a high-quality day camp experience to ALL. The project will allow young people with disabilities to build relationships with peers and positive adult role models.*

CASE for Kids County Connections Site(s): **HOUSTON TEXANS YMCA**

**Term**

Grantee must start programming on or after June 14, 2021 and end programming no later than August 15, 2021. Your grant application proposed the dates and times described on the CASE for Kids County Connections Proposed Site List. Changes to program dates or times must be submitted in writing to HCDE’s CASE division and approved by CASE in advance.

## Compensation

Upon return of (1) one signed original of the Notice of Grant Award, Grantee must submit an invoice for 80% of the grant award for payment. The final 20% of the grant award will be paid upon receipt and approval of an invoice, documentation of expenditures, and the final report as outlined below.

Grantee shall match the total amount of program grant funding on a dollar-for-dollar basis. The match may be cash or in-kind support from other sources. Grantee shall maintain sufficient documentation of its match and produce said documentation to HCDE upon request.

Grantee agrees to expend grant funding to support the proposed project, as described, to provide service for the Harris County Precinct and its constituents.

Grantee is required to submit original invoices to the HCDE Business Office ATTN: Accounts Payable. The invoices can be mailed through the postal service to HCDE Business Office ATTN: Accounts Payable 6300 Irvington Boulevard Houston, Texas 77022 or emailed to [accountspayable@hcde-texas.org](mailto:accountspayable@hcde-texas.org).

The invoice should include the following:

1. Date of invoice
2. Period of service (i.e. month of)
3. Invoice Number
4. Contact Information
5. Deliverables under the contract: CASE for Kids County Connections 2021
6. Certification of service provided through a signature by company representative.

Budget Period 2020-2021	
Project Administration	
Program Quality Improvement	\$500
Payroll & Staff	\$5,000
Professional Service	
Supplies and Materials	
Events	
Buses/Mileage	
Scholarship/Discounted Fees	
Miscellaneous	
<b>Total Budget: \$5,500</b>	

## Grantee's Requirements

1. Grant recipients must meet the following requirements, according to the schedule and deadlines set by HCDE:
  - a. Grantees shall maintain all records and accounts in a manner that shall assure full accounting of all expenditures paid for with both funds received from HCDE and local site matching funds relating to the signed Notice of Grant Award (NOGA). Grantee records and accounts shall be retained by the grantee and made available

for audit by HCDE, Harris County, or their respective representatives for a period of not less than three (3) years after the expiration or termination of the NOGA. If an audit has been announced, the grantee shall retain its records and accounts until such audit has been completed.

- b. Grantee shall comply with all applicable federal, state, and municipal laws, ordinances, rules, and regulations and certify such compliance upon request.
  - c. Complete a final report at the end of the program period, including but not limited to attendance forms and a project summary form provided by CASE for Kids detailing project accomplishments and challenges, photo documentation of the project, and promotional materials.
  - d. Submit attendance and demographics for youth served with program grant funding, in the manner required by HCDE.
  - e. Comply with evaluations required by HCDE, which may include site visits, focus groups, and surveys.
  - f. Agree to obtain and assess criminal history record information for each employee, contractor, or volunteer used in the delivery of projects funded by program grant funds and to use only those persons fit to work with students.
  - g. Submit an HCDE vendor packet to include, at a minimum, the following: W-9 Form, Conflict of Interest Form, Felony Conviction Affidavit Form, and Covered Employee Affidavit Form.
  - h. Staff members of the funded organization are eligible to attend the CASE for Kids free Afterschool Community Training Series.
  - i. Awarded organizations are required to attend two (2) mandatory meetings presented by CASE for Kids staff during the grant term on topics related to grant compliance, funding and resources on program implementation. The mandatory workshop schedule and details will be emailed to grantees.
  - j. Provides a safe and inclusive environment for youth. See details on [www.hcde-texas.org/afterschoolzone](http://www.hcde-texas.org/afterschoolzone).
2. Grantee agrees to meet CASE for Kids quality framework: element one- safe and inclusive environment and element four- collaborative relationships.

### **Program Promotion**

All promotional material or press releases for the project must include the following:



County Connections is funded in part by Harris County, and administrated by Harris County Department of Education via CASE for Kids.

Promotional materials or press releases for the project must not include:

Logos for Harris County, CASE for Kids, and Harris County Department of Education may not be used in program promotion.

### **Program Compliance & Documentation**

Grantee must adhere to all of the following requirements.

1. Final Report Form – Grantee must provide a final report form that will include a narrative that will highlight the work of the program, challenges, and overall outcome of the program. The final report must also demonstrate how the grantee enhanced program quality during the grant period, as well as provide supporting documentation. Final Report Forms must be submitted to the CASE office, 6005 Westview, Houston, TX 77055 no later than 15 days after the August 15, 2021. To conserve paper, final report and supporting documentation must be submitted items on a flash drive. Files must be in PC format.
2. Student Data Impact- Grantee must utilize the database provided by HCDE to complete attendance information, unless otherwise instructed by CASE for Kids. Grantee will also obtain demographic information through a student registration form that will be provided through the CASE for Kids County Connections Registration Form or approved grantee organization registration form.
3. Proof of expenditures – All expenditures for the awarded amount must be documented.
  - a. Copies of original receipts for expenditures, proof of payroll/professional services, and all other expenses. (Original receipts may be requested upon review of the final report.)
4. Images from project– Eight (8) digital images of the project. Images must be submitted on a USB flash drive in JPG format.
5. Promotional materials – Any materials utilized to promote the County Connections project that include or mention Harris County, CASE for Kids and Harris County Department of Education. Include examples of all promotional materials (press releases, flyers, brochures, etc.).

### **Evaluation**

Grantee may be asked to participate in a more in-depth evaluation of funding impact, which may include site visits, focus groups, and surveys. If selected for this evaluation, Grantee agrees to work with HCDE’s Division of Research and Evaluation to ensure the completion of post-project assessments.

Grantee must have an evaluation participation release form signed by a parent/guardian for each student who completes a project survey.

### **Language Assistance**

Grantee must acknowledge, in a form acceptable to HCDE where required by HCDE in a non-discriminatory manner, that it can provide reasonable assistance to non-English speaking participants in its Activity.

### **Insurance**

Grantees must provide proof of insurance, in no less than the amounts detailed in Exhibit "B" attached hereto and made a part hereof.

### **Termination**

If services are not delivered as detailed in this NOGA, the RFP, and/or Grantee's application/proposal, if Grantee does not timely submit a complete final report, if final evaluation by CASE for Kids results in concern over implementation of the project, or if Grantee does not submit evaluation pre/post assessments, the final 20% of the grant award will not be allocated, and Grantee may be required to return part or all of the previously allocated grant funding. Additionally, if Grantee does not adequately document proof of expenses, Grantee may be required to return all or a portion of the grant amount.

### **Indemnity**

**TO THE MAXIMUM EXTENT AUTHORIZED UNDER THE CONSTITUTION AND LAWS OF THE STATE OF TEXAS, GRANTEE WILL HOLD HCDE, ITS OFFICERS, AGENTS, AND EMPLOYEES HARMLESS FROM ANY AND ALL CLAIMS, DEMANDS, DAMAGES, LIABILITIES, AND COSTS WHICH RESULT FROM ANY WILLFUL MISCONDUCT OR NEGLIGENT ACT OR OMISSION OF GRANTEE, ITS OFFICERS, AGENTS, OR EMPLOYEES, PERTAINING TO ITS ACTIVITIES AND OBLIGATIONS UNDER THIS NOGA OR RELATED TO THE COUNTY CONNECTIONS PROGRAM.**

### **Non-Appropriation of Funds**

The term of this NOGA is a commitment of HCDE current revenue only. Notwithstanding anything to the contrary in this NOGA, HCDE's obligation to pay grant funds as stated herein is expressly contingent upon HCDE receiving local, state, and/or federal funds ("funds") for after-school and out-of-school activities that are sufficient to satisfy all obligations to other grantees with which HCDE contracts to provide County Connections projects. In the event HCDE does not receive those funds or sufficient funds, HCDE may terminate this NOGA and will not be responsible for paying Grantee the amount specified herein or for any of the costs of the County Connections program(s) provided by Grantee.

### **Governing Law & Venue**

This NOGA shall be governed by and construed in accordance with the laws of the State of Texas, without regard to its conflicts of laws principles. The mandatory and exclusive venue for

the adjudication or resolution of any dispute arising out of this NOGA or the County Connections project shall be in Harris County, Texas, and the parties hereby submit to the exclusive jurisdiction of said courts.

**Assignment**

Neither this NOGA nor any duties or obligations outlined in this NOGA shall be assignable by Grantee without the prior written consent of HCDE.

**Relationship**

It is understood and agreed that Grantee is an independent contractor. Nothing in this NOGA shall be interpreted or construed as creating or establishing the relationship of employer and employee between HCDE and any employee or agent of Grantee. The NOGA does not create a joint venture or business partnership under Texas law.

Grantee is solely responsible for the supervision, daily direction and control, payment of salary (including withholding of income taxes and social security), insurance, worker's compensation, and disability benefits and like requirements and obligations of Grantee's employees, agents, volunteers, and representatives.

**Amendment; Entire Agreement**

This NOGA may be amended only by the mutual agreement of the parties, in writing, to be attached to and incorporated in this NOGA.

This Notice of Grant Award ("NOGA"), HCDE's CASE for Kids County Connections Request for Proposals ("RFP"), and Grantee's proposal/application submitted in response to HCDE's RFP, and the attached and incorporated addendum or exhibits, if any, contain the entire agreement of the parties relative to the purpose(s) of the agreement and supercede any other representations, agreements, arrangements, negotiations, or understanding, oral or written, between the parties to this NOGA. In the event of a conflict between this NOGA and the RFP or Grantee's proposal/application submitted in response to the RFP, this NOGA shall control. In the event of a conflict between the RFP and Grantee's proposal/application submitted in response to the RFP, the RFP shall control.

Neither this NOGA, nor any term or provision hereof, nor any inclusion by reference, shall be construed as being for the benefit of any party not in signatory hereto.

YMCA of Greater Houston

By: *Stephen Ives*  
Stephen Ives (Jun 14, 2021 10:49 CDT)

(Signature)

Stephen Ives  
1331 Augusta Drive, Houston, TX 77057  
Phone: 713-758-9172  
Email: [stephen.ives@ymcahouston.org](mailto:stephen.ives@ymcahouston.org)

Harris County Department of Education

By: \_\_\_\_\_

(Signature)

Dr. Jesus Amezcua  
Assistant Superintendent, Business  
6300 Irvington Blvd.  
Houston, TX 77022-5618  
Phone: 713-696-8249 Fax: 713-696-0740  
Email: [jamezcua@hcde-texas.org](mailto:jamezcua@hcde-texas.org)

## Exhibit B

### GRANTEE INSURANCE REQUIREMENTS

Grantee is required to provide HCDE with copies of certificates of insurance, naming HCDE as an additional insured, for Texas Workman's Compensation and General Liability Insurance. Certificates of Insurance, name and address of Grantee, the limits of liability, the effective dates of each policy, and policy number shall be delivered to HCDE prior to commencement of any work under this Agreement. The insurance company insuring Grantee shall be licensed in the State of Texas and shall be acceptable to HCDE. Grantee shall give HCDE a minimum of ten (10) days' notice prior to any modifications or cancellation of said policies of insurance. Grantee shall require all subcontractors performing any work under or relating to this Agreement to maintain coverage as specified below.

Minimum Insurance Requirements:

- Grantee shall, at all times during the Term of this Agreement, maintain insurance coverage with not less than the type and requirements shown below. Such insurance is to be provided at the sole cost of Grantee. These requirements do not establish limits of Grantees's liability.
  - All policies of insurance shall waive all rights of subrogation against HCDE, its officers, employees, and agents.
  - Upon request, certified copies of original insurance policies shall be furnished to HCDE.
  - HCDE shall be named as an "additional insured" on all insurance policies.
  - HCDE reserves the right to require additional insurance should HCDE deem additional insurance necessary, in HCDE's sole discretion.
- A. Workers' Compensation (with Waiver of subrogation to HCDE) Employer's Liability, including all states, U.S. Longshoremen, Harbor Workers and other endorsements.
- B. Statutory, and Bodily Injury by Accident: \$100,000 each employee. Bodily Injury by Disease: \$500,000, policy limit \$100,000 each employee. Commercial General Liability Occurrence Form including, but not limited to, Premises and Operations, Products Liability Broad Form Property Damage, Contractual Liability, Personal and Advertising Injury Liability and where the exposure exists, coverage for watercraft, blasting collapse, and explosions, blowout, catering and underground damage.
- \$300,000 each occurrence Limit Bodily Injury and Property Damage combined
  - \$300,000 Products-Completed Operations Aggregate Limit \$500,000 per Job Aggregate
  - \$300,000 Personal and Advertising Injury Limit
- C. Automobile Liability Coverage  
\$300,000 Combined Liability Limits Bodily Injury and Property Damage Combined

In the event the above-detailed insurance requirements require modifications after the NOGA is executed, as determined by HCDE in its sole discretion, HCDE reserves the right to amend this Exhibit B to the NOGA, with such modifications to be effective upon written notice to Grantee, and Grantee agrees to comply with such modified requirements. Grantee acknowledges and agrees that continued payment by HCDE to Grantee under the NOGA is adequate consideration for agreeing to comply with the required insurance requirements, as modified. In the event such modified requirements are required, HCDE and Grantee agree that a formal amendment to the NOGA is not required, but the modified insurance requirements shall become effective upon written notice to Grantee.

\*\*\*\*\***NOTICE OF GRANT AWARD**\*\*\*\*\*

Project Title: CASE for Kids County Connections Youth Summer Initiative 2021  
Grant Term: June 14, 2021 – August 15, 2021  
Center for Afterschool, Summer, and Enrichment for Kids (CASE for Kids)  
Harris County Department of Education

\*\*\*\*\*

YMCA of Greater Houston  
Stephen Ives  
1331 Augusta Drive, Houston, TX 77057

Dear YMCA of Greater Houston,

The Harris County Department of Education (“HCDE”) hereby awards a grant in the amount of \$13,504 to YMCA of Greater Houston (“Grantee”) in support of the above-referenced project. This award is subject to the terms and conditions specified herein (the “NOGA”) and in HCDE’s CASE for Kids County Connections Request for Proposals (“RFP”). Acceptance of this award, including the terms and conditions detailed in this NOGA, is acknowledged by the Grantee by returning (1) one signed original to HCDE CASE for Kids, no later than June 11, 2021.

In consideration of the mutual covenants and conditions contained in this Notice of Grant Award (“NOGA”) and other good and valuable consideration, the receipt and sufficiency of which are hereby acknowledged, the parties, intending to be legally bound, agree as follows:

**Program Description**

*(YMCA Houston) mission is to put Judeo-Christian principles into practice through programs that build healthy spirit, mind, and body for all. The funded project will seek to hire new specialized YMCA Youth Counselors (Youth Development Counselor for Young People with Disabilities - YDCYPD) at each of the two YMCA locations noted. The YMCA Inclusion Team and YMCA Day Camp will work with parents and young people to ensure that all required and requested accommodations are provided to deliver a high-quality day camp experience to ALL. The project will allow young people with disabilities to build relationships with peers and positive adult role models.*

CASE for Kids County Connections Site(s): **ALIEF FAMILY YMCA**  
**LANGHAM CREEK FAMILY**  
**TROTTER FAMILY**

**Term**

Grantee must start programming on or after June 14, 2021 and end programming no later than August 15, 2021. Your grant application proposed the dates and times described on the CASE

for Kids County Connections Proposed Site List. Changes to program dates or times must be submitted in writing to HCDE’s CASE division and approved by CASE in advance.

**Compensation**

Upon return of (1) one signed original of the Notice of Grant Award, Grantee must submit an invoice for 80% of the grant award for payment. The final 20% of the grant award will be paid upon receipt and approval of an invoice, documentation of expenditures, and the final report as outlined below.

Grantee shall match the total amount of program grant funding on a dollar-for-dollar basis. The match may be cash or in-kind support from other sources. Grantee shall maintain sufficient documentation of its match and produce said documentation to HCDE upon request.

Grantee agrees to expend grant funding to support the proposed project, as described, to provide service for the Harris County Precinct and its constituents.

Grantee is required to submit original invoices to the HCDE Business Office ATTN: Accounts Payable. The invoices can be mailed through the postal service to HCDE Business Office ATTN: Accounts Payable 6300 Irvington Boulevard Houston, Texas 77022 or emailed to [accountspayable@hcde-texas.org](mailto:accountspayable@hcde-texas.org).

The invoice should include the following:

1. Date of invoice
2. Period of service (i.e. month of)
3. Invoice Number
4. Contact Information
5. Deliverables under the contract: CASE for Kids County Connections 2021
6. Certification of service provided through a signature by company representative.

Budget Period 2020-2021	
Project Administration	\$
Program Quality Improvement	\$1,200
Payroll & Staff	\$12,304
Professional Service	\$
Supplies and Materials	\$
Events	\$
Buses/Mileage	\$
Scholarship/Discounted Fees	
Miscellaneous	\$
<b>Total Budget: \$13,504</b>	

**Grantee’s Requirements**

1. Grant recipients must meet the following requirements, according to the schedule and deadlines set by HCDE:

- a. Grantees shall maintain all records and accounts in a manner that shall assure full accounting of all expenditures paid for with both funds received from HCDE and local site matching funds relating to the signed Notice of Grant Award (NOGA). Grantee records and accounts shall be retained by the grantee and made available for audit by HCDE, Harris County, or their respective representatives for a period of not less than three (3) years after the expiration or termination of the NOGA. If an audit has been announced, the grantee shall retain its records and accounts until such audit has been completed.
  - b. Grantee shall comply with all applicable federal, state, and municipal laws, ordinances, rules, and regulations and certify such compliance upon request.
  - c. Complete a final report at the end of the program period, including but not limited to attendance forms and a project summary form provided by CASE for Kids detailing project accomplishments and challenges, photo documentation of the project, and promotional materials.
  - d. Submit attendance and demographics for youth served with program grant funding, in the manner required by HCDE.
  - e. Comply with evaluations required by HCDE, which may include site visits, focus groups, and surveys.
  - f. Agree to obtain and assess criminal history record information for each employee, contractor, or volunteer used in the delivery of projects funded by program grant funds and to use only those persons fit to work with students.
  - g. Submit an HCDE vendor packet to include, at a minimum, the following: W-9 Form, Conflict of Interest Form, Felony Conviction Affidavit Form, and Covered Employee Affidavit Form.
  - h. Staff members of the funded organization are eligible to attend the CASE for Kids free Afterschool Community Training Series.
  - i. Awarded organizations are required to attend two (2) mandatory meetings presented by CASE for Kids staff during the grant term on topics related to grant compliance, funding and resources on program implementation. The mandatory workshop schedule and details will be emailed to grantees.
  - j. Provides a safe and inclusive environment for youth. See details on [www.hcde-texas.org/afterschoolzone](http://www.hcde-texas.org/afterschoolzone).
2. Grantee agrees to meet CASE for Kids quality framework: element one- safe and inclusive environment and element four- collaborative relationships.



## **Program Promotion**

All promotional material or press releases for the project must include the following: County Connections is funded in part by Harris County, and administrated by Harris County Department of Education via CASE for Kids.

Promotional materials or press releases for the project must not include: Logos for Harris County, CASE for Kids, and Harris County Department of Education may not be used in program promotion.

## **Program Compliance & Documentation**

Grantee must adhere to all of the following requirements.

1. Final Report Form – Grantee must provide a final report form that will include a narrative that will highlight the work of the program, challenges, and overall outcome of the program. The final report must also demonstrate how the grantee enhanced program quality during the grant period, as well as provide supporting documentation. Final Report Forms must be submitted to the CASE office, 6005 Westview, Houston, TX 77055 no later than 15 days after the August 15, 2021. To conserve paper, final report and supporting documentation must be submitted items on a flash drive. Files must be in PC format.
2. Student Data Impact- Grantee must utilize the database provided by HCDE to complete attendance information, unless otherwise instructed by CASE for Kids. Grantee will also obtain demographic information through a student registration form that will be provided through the CASE for Kids County Connections Registration Form or approved grantee organization registration form.
3. Proof of expenditures – All expenditures for the awarded amount must be documented.
  - a. Copies of original receipts for expenditures, proof of payroll/professional services, and all other expenses. (Original receipts may be requested upon review of the final report.)
4. Images from project– Eight (8) digital images of the project. Images must be submitted on a USB flash drive in JPG format.
5. Promotional materials – Any materials utilized to promote the County Connections project that include or mention Harris County, CASE for Kids and Harris County Department of Education. Include examples of all promotional materials (press releases, flyers, brochures, etc.).

## **Evaluation**

Grantee may be asked to participate in a more in-depth evaluation of funding impact, which may include site visits, focus groups, and surveys. If selected for this evaluation, Grantee agrees to work with HCDE's Division of Research and Evaluation to ensure the completion of post-project assessments.

Grantee must have an evaluation participation release form signed by a parent/guardian for each student who completes a project survey.

### **Language Assistance**

Grantee must acknowledge, in a form acceptable to HCDE where required by HCDE in a non-discriminatory manner, that it can provide reasonable assistance to non-English speaking participants in its Activity.

### **Insurance**

Grantees must provide proof of insurance, in no less than the amounts detailed in Exhibit "B" attached hereto and made a part hereof.

### **Termination**

If services are not delivered as detailed in this NOGA, the RFP, and/or Grantee's application/proposal, if Grantee does not timely submit a complete final report, if final evaluation by CASE for Kids results in concern over implementation of the project, or if Grantee does not submit evaluation pre/post assessments, the final 20% of the grant award will not be allocated, and Grantee may be required to return part or all of the previously allocated grant funding. Additionally, if Grantee does not adequately document proof of expenses, Grantee may be required to return all or a portion of the grant amount.

### **Indemnity**

**TO THE MAXIMUM EXTENT AUTHORIZED UNDER THE CONSTITUTION AND LAWS OF THE STATE OF TEXAS, GRANTEE WILL HOLD HCDE, ITS OFFICERS, AGENTS, AND EMPLOYEES HARMLESS FROM ANY AND ALL CLAIMS, DEMANDS, DAMAGES, LIABILITIES, AND COSTS WHICH RESULT FROM ANY WILLFUL MISCONDUCT OR NEGLIGENT ACT OR OMISSION OF GRANTEE, ITS OFFICERS, AGENTS, OR EMPLOYEES, PERTAINING TO ITS ACTIVITIES AND OBLIGATIONS UNDER THIS NOGA OR RELATED TO THE COUNTY CONNECTIONS PROGRAM.**

### **Non-Appropriation of Funds**

The term of this NOGA is a commitment of HCDE current revenue only. Notwithstanding anything to the contrary in this NOGA, HCDE's obligation to pay grant funds as stated herein is expressly contingent upon HCDE receiving local, state, and/or federal funds ("funds") for after-school and out-of-school activities that are sufficient to satisfy all obligations to other grantees with which HCDE contracts to provide County Connections projects. In the event HCDE does not receive those funds or sufficient funds, HCDE may terminate this NOGA and will not be responsible for paying Grantee the amount specified herein or for any of the costs of the County Connections program(s) provided by Grantee.

**Governing Law & Venue**

This NOGA shall be governed by and construed in accordance with the laws of the State of Texas, without regard to its conflicts of laws principles. The mandatory and exclusive venue for the adjudication or resolution of any dispute arising out of this NOGA or the County Connections project shall be in Harris County, Texas, and the parties hereby submit to the exclusive jurisdiction of said courts.

**Assignment**

Neither this NOGA nor any duties or obligations outlined in this NOGA shall be assignable by Grantee without the prior written consent of HCDE.

**Relationship**

It is understood and agreed that Grantee is an independent contractor. Nothing in this NOGA shall be interpreted or construed as creating or establishing the relationship of employer and employee between HCDE and any employee or agent of Grantee. The NOGA does not create a joint venture or business partnership under Texas law.

Grantee is solely responsible for the supervision, daily direction and control, payment of salary (including withholding of income taxes and social security), insurance, worker's compensation, and disability benefits and like requirements and obligations of Grantee's employees, agents, volunteers, and representatives.

**Amendment; Entire Agreement**

This NOGA may be amended only by the mutual agreement of the parties, in writing, to be attached to and incorporated in this NOGA.

This Notice of Grant Award ("NOGA"), HCDE's CASE for Kids County Connections Request for Proposals ("RFP"), and Grantee's proposal/application submitted in response to HCDE's RFP, and the attached and incorporated addendum or exhibits, if any, contain the entire agreement of the parties relative to the purpose(s) of the agreement and supercede any other representations, agreements, arrangements, negotiations, or understanding, oral or written, between the parties to this NOGA. In the event of a conflict between this NOGA and the RFP or Grantee's proposal/application submitted in response to the RFP, this NOGA shall control. In the event of a conflict between the RFP and Grantee's proposal/application submitted in response to the RFP, the RFP shall control.

Neither this NOGA, nor any term or provision hereof, nor any inclusion by reference, shall be construed as being for the benefit of any party not in signatory hereto.

YMCA of Greater Houston

By: *Stephen Ives*  
Stephen Ives (Jun 15, 2021 13:12 CDT)

(Signature)

Stephen Ives  
1331 Augusta Drive, Houston, TX 77057  
Phone: 713-758-9172  
Email: [stephen.ives@ymcahouston.org](mailto:stephen.ives@ymcahouston.org)

Harris County Department of Education

By: \_\_\_\_\_

(Signature)

Dr. Jesus Amezcua  
Assistant Superintendent, Business  
6300 Irvington Blvd.  
Houston, TX 77022-5618  
Phone: 713-696-8249 Fax: 713-696-0740  
Email: [jamezcua@hcde-texas.org](mailto:jamezcua@hcde-texas.org)

## Exhibit B

### GRANTEE INSURANCE REQUIREMENTS

Grantee is required to provide HCDE with copies of certificates of insurance, naming HCDE as an additional insured, for Texas Workman's Compensation and General Liability Insurance. Certificates of Insurance, name and address of Grantee, the limits of liability, the effective dates of each policy, and policy number shall be delivered to HCDE prior to commencement of any work under this Agreement. The insurance company insuring Grantee shall be licensed in the State of Texas and shall be acceptable to HCDE. Grantee shall give HCDE a minimum of ten (10) days' notice prior to any modifications or cancellation of said policies of insurance. Grantee shall require all subcontractors performing any work under or relating to this Agreement to maintain coverage as specified below.

Minimum Insurance Requirements:

- Grantee shall, at all times during the Term of this Agreement, maintain insurance coverage with not less than the type and requirements shown below. Such insurance is to be provided at the sole cost of Grantee. These requirements do not establish limits of Grantees's liability.
  - All policies of insurance shall waive all rights of subrogation against HCDE, its officers, employees, and agents.
  - Upon request, certified copies of original insurance policies shall be furnished to HCDE.
  - HCDE shall be named as an "additional insured" on all insurance policies.
  - HCDE reserves the right to require additional insurance should HCDE deem additional insurance necessary, in HCDE's sole discretion.
- A. Workers' Compensation (with Waiver of subrogation to HCDE) Employer's Liability, including all states, U.S. Longshoremen, Harbor Workers and other endorsements.
- B. Statutory, and Bodily Injury by Accident: \$100,000 each employee. Bodily Injury by Disease: \$500,000, policy limit \$100,000 each employee. Commercial General Liability Occurrence Form including, but not limited to, Premises and Operations, Products Liability Broad Form Property Damage, Contractual Liability, Personal and Advertising Injury Liability and where the exposure exists, coverage for watercraft, blasting collapse, and explosions, blowout, catering and underground damage.
- \$300,000 each occurrence Limit Bodily Injury and Property Damage combined
  - \$300,000 Products-Completed Operations Aggregate Limit \$500,000 per Job Aggregate
  - \$300,000 Personal and Advertising Injury Limit
- C. Automobile Liability Coverage  
\$300,000 Combined Liability Limits Bodily Injury and Property Damage Combined

In the event the above-detailed insurance requirements require modifications after the NOGA is executed, as determined by HCDE in its sole discretion, HCDE reserves the right to amend this Exhibit B to the NOGA, with such modifications to be effective upon written notice to Grantee, and Grantee agrees to comply with such modified requirements. Grantee acknowledges and agrees that continued payment by HCDE to Grantee under the NOGA is adequate consideration for agreeing to comply with the required insurance requirements, as modified. In the event such modified requirements are required, HCDE and Grantee agree that a formal amendment to the NOGA is not required, but the modified insurance requirements shall become effective upon written notice to Grantee.

\*\*\*\*\*NOTICE OF GRANT AWARD\*\*\*\*\*

Project Title: CASE for Kids County Connections Youth Summer Initiative 2021  
Grant Term: June 14, 2021 – August 15, 2021  
Center for Afterschool, Summer, and Enrichment for Kids (CASE for Kids)  
Harris County Department of Education

\*\*\*\*\*

YMCA of Greater Houston  
Stephen Ives  
1331 Augusta Dr, Houston TX 77057

Dear YMCA of Greater Houston,

The Harris County Department of Education (“HCDE”) hereby awards a grant in the amount of \$10,996 to YMCA of Greater Houston (“Grantee”) in support of the above-referenced project. This award is subject to the terms and conditions specified herein (the “NOGA”) and in HCDE’s CASE for Kids County Connections Request for Proposals (“RFP”). Acceptance of this award, including the terms and conditions detailed in this NOGA, is acknowledged by the Grantee by returning (1) one signed original to HCDE CASE for Kids, no later than June 11, 2021.

In consideration of the mutual covenants and conditions contained in this Notice of Grant Award (“NOGA”) and other good and valuable consideration, the receipt and sufficiency of which are hereby acknowledged, the parties, intending to be legally bound, agree as follows:

**Program Description**

*(YMCA Houston) mission is to put Judeo-Christian principles into practice through programs that build healthy spirit, mind, and body for all. The funded project will seek to hire new specialized YMCA Youth Counselors (Youth Development Counselor for Young People with Disabilities - YDCYPD) at each of the two YMCA locations noted. The YMCA Inclusion Team and YMCA Day Camp will work with parents and young people to ensure that all required and requested accommodations are provided to deliver a high-quality day camp experience to ALL. The project will allow young people with disabilities to build relationships with peers and positive adult role models.*

CASE for Kids County Connections Site(s): **Lake Houston Family YMCA**  
**THE WOMENS HOME**

**Term**

Grantee must start programming on or after June 14, 2021 and end programming no later than August 15, 2021. Your grant application proposed the dates and times described on the CASE for Kids County Connections Proposed Site List. Changes to program dates or times must be submitted in writing to HCDE’s CASE division and approved by CASE in advance.

## Compensation

Upon return of (1) one signed original of the Notice of Grant Award, Grantee must submit an invoice for 80% of the grant award for payment. The final 20% of the grant award will be paid upon receipt and approval of an invoice, documentation of expenditures, and the final report as outlined below.

Grantee shall match the total amount of program grant funding on a dollar-for-dollar basis. The match may be cash or in-kind support from other sources. Grantee shall maintain sufficient documentation of its match and produce said documentation to HCDE upon request.

Grantee agrees to expend grant funding to support the proposed project, as described, to provide service for the Harris County Precinct and its constituents.

Grantee is required to submit original invoices to the HCDE Business Office ATTN: Accounts Payable. The invoices can be mailed through the postal service to HCDE Business Office ATTN: Accounts Payable 6300 Irvington Boulevard Houston, Texas 77022 or emailed to [accountspayable@hcde-texas.org](mailto:accountspayable@hcde-texas.org).

The invoice should include the following:

1. Date of invoice
2. Period of service (i.e. month of)
3. Invoice Number
4. Contact Information
5. Deliverables under the contract: CASE for Kids County Connections 2021
6. Certification of service provided through a signature by company representative.

Budget Period 2020-2021	
Project Administration	
Program Quality Improvement	\$800
Payroll & Staff	\$10,196
Professional Service	
Supplies and Materials	
Events	
Buses/Mileage	
Scholarship/Discounted Fees	
Miscellaneous	
<b>Total Budget: \$10,996</b>	

## Grantee's Requirements

1. Grant recipients must meet the following requirements, according to the schedule and deadlines set by HCDE:
  - a. Grantees shall maintain all records and accounts in a manner that shall assure full accounting of all expenditures paid for with both funds received from HCDE and local site matching funds relating to the signed Notice of Grant Award (NOGA).

Grantee records and accounts shall be retained by the grantee and made available for audit by HCDE, Harris County, or their respective representatives for a period of not less than three (3) years after the expiration or termination of the NOGA. If an audit has been announced, the grantee shall retain its records and accounts until such audit has been completed.

- b. Grantee shall comply with all applicable federal, state, and municipal laws, ordinances, rules, and regulations and certify such compliance upon request.
  - c. Complete a final report at the end of the program period, including but not limited to attendance forms and a project summary form provided by CASE for Kids detailing project accomplishments and challenges, photo documentation of the project, and promotional materials.
  - d. Submit attendance and demographics for youth served with program grant funding, in the manner required by HCDE.
  - e. Comply with evaluations required by HCDE, which may include site visits, focus groups, and surveys.
  - f. Agree to obtain and assess criminal history record information for each employee, contractor, or volunteer used in the delivery of projects funded by program grant funds and to use only those persons fit to work with students.
  - g. Submit an HCDE vendor packet to include, at a minimum, the following: W-9 Form, Conflict of Interest Form, Felony Conviction Affidavit Form, and Covered Employee Affidavit Form.
  - h. Staff members of the funded organization are eligible to attend the CASE for Kids free Afterschool Community Training Series.
  - i. Awarded organizations are required to attend two (2) mandatory meetings presented by CASE for Kids staff during the grant term on topics related to grant compliance, funding and resources on program implementation. The mandatory workshop schedule and details will be emailed to grantees.
  - j. Provides a safe and inclusive environment for youth. See details on [www.hcde-texas.org/afterschoolzone](http://www.hcde-texas.org/afterschoolzone).
2. Grantee agrees to meet CASE for Kids quality framework: element one- safe and inclusive environment and element four- collaborative relationships.

### **Program Promotion**

All promotional material or press releases for the project must include the following:



County Connections is funded in part by Harris County, and administrated by Harris County Department of Education via CASE for Kids.

Promotional materials or press releases for the project must not include:

Logos for Harris County, CASE for Kids, and Harris County Department of Education may not be used in program promotion.

### **Program Compliance & Documentation**

Grantee must adhere to all of the following requirements.

1. Final Report Form – Grantee must provide a final report form that will include a narrative that will highlight the work of the program, challenges, and overall outcome of the program. The final report must also demonstrate how the grantee enhanced program quality during the grant period, as well as provide supporting documentation. Final Report Forms must be submitted to the CASE office, 6005 Westview, Houston, TX 77055 no later than 15 days after the August 15, 2021. To conserve paper, final report and supporting documentation must be submitted items on a flash drive. Files must be in PC format.
2. Student Data Impact- Grantee must utilize the database provided by HCDE to complete attendance information, unless otherwise instructed by CASE for Kids. Grantee will also obtain demographic information through a student registration form that will be provided through the CASE for Kids County Connections Registration Form or approved grantee organization registration form.
3. Proof of expenditures – All expenditures for the awarded amount must be documented.
  - a. Copies of original receipts for expenditures, proof of payroll/professional services, and all other expenses. (Original receipts may be requested upon review of the final report.)
4. Images from project– Eight (8) digital images of the project. Images must be submitted on a USB flash drive in JPG format.
5. Promotional materials – Any materials utilized to promote the County Connections project that include or mention Harris County, CASE for Kids and Harris County Department of Education. Include examples of all promotional materials (press releases, flyers, brochures, etc.).

### **Evaluation**

Grantee may be asked to participate in a more in-depth evaluation of funding impact, which may include site visits, focus groups, and surveys. If selected for this evaluation, Grantee agrees to work with HCDE’s Division of Research and Evaluation to ensure the completion of post-project assessments.

Grantee must have an evaluation participation release form signed by a parent/guardian for each student who completes a project survey.

### **Language Assistance**

Grantee must acknowledge, in a form acceptable to HCDE where required by HCDE in a non-discriminatory manner, that it can provide reasonable assistance to non-English speaking participants in its Activity.

### **Insurance**

Grantees must provide proof of insurance, in no less than the amounts detailed in Exhibit "B" attached hereto and made a part hereof.

### **Termination**

If services are not delivered as detailed in this NOGA, the RFP, and/or Grantee's application/proposal, if Grantee does not timely submit a complete final report, if final evaluation by CASE for Kids results in concern over implementation of the project, or if Grantee does not submit evaluation pre/post assessments, the final 20% of the grant award will not be allocated, and Grantee may be required to return part or all of the previously allocated grant funding. Additionally, if Grantee does not adequately document proof of expenses, Grantee may be required to return all or a portion of the grant amount.

### **Indemnity**

**TO THE MAXIMUM EXTENT AUTHORIZED UNDER THE CONSTITUTION AND LAWS OF THE STATE OF TEXAS, GRANTEE WILL HOLD HCDE, ITS OFFICERS, AGENTS, AND EMPLOYEES HARMLESS FROM ANY AND ALL CLAIMS, DEMANDS, DAMAGES, LIABILITIES, AND COSTS WHICH RESULT FROM ANY WILLFUL MISCONDUCT OR NEGLIGENT ACT OR OMISSION OF GRANTEE, ITS OFFICERS, AGENTS, OR EMPLOYEES, PERTAINING TO ITS ACTIVITIES AND OBLIGATIONS UNDER THIS NOGA OR RELATED TO THE COUNTY CONNECTIONS PROGRAM.**

### **Non-Appropriation of Funds**

The term of this NOGA is a commitment of HCDE current revenue only. Notwithstanding anything to the contrary in this NOGA, HCDE's obligation to pay grant funds as stated herein is expressly contingent upon HCDE receiving local, state, and/or federal funds ("funds") for after-school and out-of-school activities that are sufficient to satisfy all obligations to other grantees with which HCDE contracts to provide County Connections projects. In the event HCDE does not receive those funds or sufficient funds, HCDE may terminate this NOGA and will not be responsible for paying Grantee the amount specified herein or for any of the costs of the County Connections program(s) provided by Grantee.

### **Governing Law & Venue**

This NOGA shall be governed by and construed in accordance with the laws of the State of Texas, without regard to its conflicts of laws principles. The mandatory and exclusive venue for

the adjudication or resolution of any dispute arising out of this NOGA or the County Connections project shall be in Harris County, Texas, and the parties hereby submit to the exclusive jurisdiction of said courts.

**Assignment**

Neither this NOGA nor any duties or obligations outlined in this NOGA shall be assignable by Grantee without the prior written consent of HCDE.

**Relationship**

It is understood and agreed that Grantee is an independent contractor. Nothing in this NOGA shall be interpreted or construed as creating or establishing the relationship of employer and employee between HCDE and any employee or agent of Grantee. The NOGA does not create a joint venture or business partnership under Texas law.

Grantee is solely responsible for the supervision, daily direction and control, payment of salary (including withholding of income taxes and social security), insurance, worker's compensation, and disability benefits and like requirements and obligations of Grantee's employees, agents, volunteers, and representatives.

**Amendment; Entire Agreement**

This NOGA may be amended only by the mutual agreement of the parties, in writing, to be attached to and incorporated in this NOGA.

This Notice of Grant Award ("NOGA"), HCDE's CASE for Kids County Connections Request for Proposals ("RFP"), and Grantee's proposal/application submitted in response to HCDE's RFP, and the attached and incorporated addendum or exhibits, if any, contain the entire agreement of the parties relative to the purpose(s) of the agreement and supercede any other representations, agreements, arrangements, negotiations, or understanding, oral or written, between the parties to this NOGA. In the event of a conflict between this NOGA and the RFP or Grantee's proposal/application submitted in response to the RFP, this NOGA shall control. In the event of a conflict between the RFP and Grantee's proposal/application submitted in response to the RFP, the RFP shall control.

Neither this NOGA, nor any term or provision hereof, nor any inclusion by reference, shall be construed as being for the benefit of any party not in signatory hereto.

YMCA of Greater Houston

By: *Stephen Ives*  
By: Stephen Ives (Jun 15, 2021 13:12 CDT)

(Signature)

Stephen Ives  
1331 Augusta Dr, Houston TX 77057  
Phone: 713758-9172  
Email: [stephen.ives@ymcahouston.org](mailto:stephen.ives@ymcahouston.org)

Harris County Department of Education

By: \_\_\_\_\_

(Signature)

Dr. Jesus Amezcua  
Assistant Superintendent, Business  
6300 Irvington Blvd.  
Houston, TX 77022-5618  
Phone: 713-696-8249 Fax: 713-696-0740  
Email: [jamezcua@hcde-texas.org](mailto:jamezcua@hcde-texas.org)

## Exhibit B

### GRANTEE INSURANCE REQUIREMENTS

Grantee is required to provide HCDE with copies of certificates of insurance, naming HCDE as an additional insured, for Texas Workman's Compensation and General Liability Insurance. Certificates of Insurance, name and address of Grantee, the limits of liability, the effective dates of each policy, and policy number shall be delivered to HCDE prior to commencement of any work under this Agreement. The insurance company insuring Grantee shall be licensed in the State of Texas and shall be acceptable to HCDE. Grantee shall give HCDE a minimum of ten (10) days' notice prior to any modifications or cancellation of said policies of insurance. Grantee shall require all subcontractors performing any work under or relating to this Agreement to maintain coverage as specified below.

#### Minimum Insurance Requirements:

- Grantee shall, at all times during the Term of this Agreement, maintain insurance coverage with not less than the type and requirements shown below. Such insurance is to be provided at the sole cost of Grantee. These requirements do not establish limits of Grantees's liability.
  - All policies of insurance shall waive all rights of subrogation against HCDE, its officers, employees, and agents.
  - Upon request, certified copies of original insurance policies shall be furnished to HCDE.
  - HCDE shall be named as an "additional insured" on all insurance policies.
  - HCDE reserves the right to require additional insurance should HCDE deem additional insurance necessary, in HCDE's sole discretion.
- A. Workers' Compensation (with Waiver of subrogation to HCDE) Employer's Liability, including all states, U.S. Longshoremen, Harbor Workers and other endorsements.
- B. Statutory, and Bodily Injury by Accident: \$100,000 each employee. Bodily Injury by Disease: \$500,000, policy limit \$100,000 each employee. Commercial General Liability Occurrence Form including, but not limited to, Premises and Operations, Products Liability Broad Form Property Damage, Contractual Liability, Personal and Advertising Injury Liability and where the exposure exists, coverage for watercraft, blasting collapse, and explosions, blowout, catering and underground damage.
- \$300,000 each occurrence Limit Bodily Injury and Property Damage combined
  - \$300,000 Products-Completed Operations Aggregate Limit \$500,000 per Job Aggregate
  - \$300,000 Personal and Advertising Injury Limit
- C. Automobile Liability Coverage  
\$300,000 Combined Liability Limits Bodily Injury and Property Damage Combined

In the event the above-detailed insurance requirements require modifications after the NOGA is executed, as determined by HCDE in its sole discretion, HCDE reserves the right to amend this Exhibit B to the NOGA, with such modifications to be effective upon written notice to Grantee, and Grantee agrees to comply with such modified requirements. Grantee acknowledges and agrees that continued payment by HCDE to Grantee under the NOGA is adequate consideration for agreeing to comply with the required insurance requirements, as modified. In the event such modified requirements are required, HCDE and Grantee agree that a formal amendment to the NOGA is not required, but the modified insurance requirements shall become effective upon written notice to Grantee.

**Regular Board Meeting**

**8.D.9.**

**Meeting Date:** July 21, 2021

**Title:** Service Agreement (Expenditure) with Houston Tennis Association for CASE for Kids County Connections Youth Summer Initiative

**Submitted For:** Lisa Caruthers, Case for Kids      **Submitted By:** Kimberlee Flowers

**Recommended Action:** Approve      **HCDE Goal(s):** 1. Impact education/respond to evolving needs  
2. Deliver value responsibly  
3. Advocate for learners through innovation

**Additional Resource Personnel:** Danielle Bartz, Dr. Lisa Caruthers, Dr. Jesus Amezcua, Bill Monroe, Kendra Jackson      **Facilities/Technology Approval Needed?:**

**Information**

**Posted Agenda Item:**

**Ratification of award RFP#21/044KJ for County Connections-Youth Summer Initiative and Approve aggregate expenditures of \$58,900 from CASE for Kids to the Houston Tennis Association** County Connections’ grant award (Expenditure Contracts) totaling \$30,900 for Houston Tennis Association for Summer 2021 programming is in addition to prior awards of \$20,000 in Partnership Project funding and \$8,000 Select Service funding for a total aggregate amount of \$58,900. County Connections will increase number of students served, number of sites served and/or timeframe in which students are served.

**Subject:**

Service Agreement (Expenditure) with Houston Tennis Association for CASE for Kids County Connections-Youth Summer Initiative.

**Rationale:**

County Connections Youth Summer Initiative 2021, funded directly by Harris County, supports nonprofit organizations that address the need for youth services during the summer. Initiatives funded by the CASE for Kids County Connections program can provide comprehensive summer programs, short term projects and summer camps hosted in-person or virtually from a variety of locations including schools, community centers, apartment complexes and churches. Initiatives are customized to meet community needs of individual Harris County Precincts. Services must include resources or reduce cost for summer initiatives for families during pandemic conditions.

The following Houston Tennis Association locations will receive \$9,700 in funding for Cleveland Park, Clinton Park, Crestmont Park, Dodson Park, Finnigan Park, Haviland Park, Highland Park, Hutchenson Park, Melrose Park, Platou Park, Sagemont Park, Scenic Woods Park, Sunnyside Park, Tidwell Park, Westwood Park, Winsor Village Park to serve a total of 384 students in Precinct 1; \$12,800 in funding for Charleton Park, Meadowcreek Park, Montie Beach Park, Moody Park, Wilson Memorial Park, Woodland Park, Mason Park, Dow Park, Freeway Manor Park, Greenwood Park, Hartman Park, Keith-Weiss Park, and Settegast Park to serve a total of 312 students in Precinct 2; \$8,400 in funding for Graham Park, Memorial Park, Johnson Park, Cole Park, Mangum Park, and Wright-Bambry Park to serve a total of 168 students in Precinct 4. This service agreement is in addition to a prior Partnership Project grant award for \$20,000 to serve 60 students at LeClear Tennis Center and prior Select Service Contract for \$8,000 to serve 60 students at 5 CASE for Kids 21CCLC sites, for a total aggregate amount of \$58,900 in expenditures from CASE for Kids.

---

## Fiscal Impact

## Attachments

NOGA Prec4

NOGA Prec2

NOGA Prec1

---

## Form Review

### Inbox

CASE

Purchasing

Assistant Superintendent - Business

Form Started By: Kimberlee Flowers

Final Approval Date: 07/09/2021

### Reviewed By

Lisa Caruthers

Yaritza Roman

Jesus Amezcua

### Date

06/28/2021 06:13 PM

07/07/2021 04:34 PM

07/09/2021 03:54 PM

Started On: 06/28/2021 03:10 PM

\*\*\*\*\*NOTICE OF GRANT AWARD\*\*\*\*\*

Project Title: CASE for Kids County Connections Youth Summer Initiative 2021  
Grant Term: June 14, 2021 – August 15, 2021  
Center for Afterschool, Summer, and Enrichment for Kids (CASE for Kids)  
Harris County Department of Education

\*\*\*\*\*

Houston Tennis Association  
Cheryl HULTQUIST  
3535 BRIARPARK DR. STE. 215, Houston, TX 77042

Dear Houston Tennis Association,

The Harris County Department of Education (“HCDE”) hereby awards a grant in the amount of \$8,400 to Houston Tennis Association (“Grantee”) in support of the above-referenced project. This award is subject to the terms and conditions specified herein (the “NOGA”) and in HCDE’s CASE for Kids County Connections Request for Proposals (“RFP”). Acceptance of this award, including the terms and conditions detailed in this NOGA, is acknowledged by the Grantee by returning (1) one signed original to HCDE CASE for Kids, no later than June 11, 2021.

In consideration of the mutual covenants and conditions contained in this Notice of Grant Award (“NOGA”) and other good and valuable consideration, the receipt and sufficiency of which are hereby acknowledged, the parties, intending to be legally bound, agree as follows:

**Program Description**

*The Houston Tennis Association is to encourage and promote tennis Houston regardless of age, gender, disability or level of play. Our ultimate goal is to support and foster good health and sportsmanship through tennis, the sport of a lifetime. HTA NJTL (National Junior Tennis and Learning) focuses on youth development through tennis, education and scholarship programs serving 45+ neighborhood parks and schools each year. Conducted in a manner with social equity in mind, locations penetrate areas of where tennis has never been offered before reaching diverse communities of varying ethniCounty and socioeconomic levels.*

CASE for Kids County Connections Site(s): ***Graham Park  
Memorial Park  
Johnson Park  
Cole Creek Park  
Mangum Park  
Wright-Bambry Park***

**Term**



Grantee must start programming on or after June 14, 2021 and end programming no later than August 15, 2021. Your grant application proposed the dates and times described on the CASE for Kids County Connections Proposed Site List. Changes to program dates or times must be submitted in writing to HCDE’s CASE division and approved by CASE in advance.

**Compensation**

Upon return of (1) one signed original of the Notice of Grant Award, Grantee must submit an invoice for 80% of the grant award for payment. The final 20% of the grant award will be paid upon receipt and approval of an invoice, documentation of expenditures, and the final report as outlined below.

Grantee shall match the total amount of program grant funding on a dollar-for-dollar basis. The match may be cash or in-kind support from other sources. Grantee shall maintain sufficient documentation of its match and produce said documentation to HCDE upon request.

Grantee agrees to expend grant funding to support the proposed project, as described, to provide service for the Harris County Precinct and its constituents.

Grantee is required to submit original invoices to the HCDE Business Office ATTN: Accounts Payable. The invoices can be mailed through the postal service to HCDE Business Office ATTN: Accounts Payable 6300 Irvington Boulevard Houston, Texas 77022 or emailed to [accountspayable@hcde-texas.org](mailto:accountspayable@hcde-texas.org).

The invoice should include the following:

1. Date of invoice
2. Period of service (i.e. month of)
3. Invoice Number
4. Contact Information
5. Deliverables under the contract: CASE for Kids County Connections 2021
6. Certification of service provided through a signature by company representative.

Budget Period 2020-2021	
Project Administration	\$180
Program Quality Improvement	\$200
Payroll & Staff	\$5,040
Professional Service	\$190
Supplies and Materials	\$2,520
Events	
Buses/Mileage	
Scholarship/Discounted Fees	\$150
Miscellaneous	\$120
<b>Total Budget: \$8,400</b>	

**Grantee’s Requirements**

1. Grant recipients must meet the following requirements, according to the schedule and deadlines set by HCDE:

- a. Grantees shall maintain all records and accounts in a manner that shall assure full accounting of all expenditures paid for with both funds received from HCDE and local site matching funds relating to the signed Notice of Grant Award (NOGA). Grantee records and accounts shall be retained by the grantee and made available for audit by HCDE, Harris County, or their respective representatives for a period of not less than three (3) years after the expiration or termination of the NOGA. If an audit has been announced, the grantee shall retain its records and accounts until such audit has been completed.
  - b. Grantee shall comply with all applicable federal, state, and municipal laws, ordinances, rules, and regulations and certify such compliance upon request.
  - c. Complete a final report at the end of the program period, including but not limited to attendance forms and a project summary form provided by CASE for Kids detailing project accomplishments and challenges, photo documentation of the project, and promotional materials.
  - d. Submit attendance and demographics for youth served with program grant funding, in the manner required by HCDE.
  - e. Comply with evaluations required by HCDE, which may include site visits, focus groups, and surveys.
  - f. Agree to obtain and assess criminal history record information for each employee, contractor, or volunteer used in the delivery of projects funded by program grant funds and to use only those persons fit to work with students.
  - g. Submit an HCDE vendor packet to include, at a minimum, the following: W-9 Form, Conflict of Interest Form, Felony Conviction Affidavit Form, and Covered Employee Affidavit Form.
  - h. Staff members of the funded organization are eligible to attend the CASE for Kids free Afterschool Community Training Series.
  - i. Awarded organizations are required to attend two (2) mandatory meetings presented by CASE for Kids staff during the grant term on topics related to grant compliance, funding and resources on program implementation. The mandatory workshop schedule and details will be emailed to grantees.
  - j. Provides a safe and inclusive environment for youth. See details on [www.hcde-texas.org/afterschoolzone](http://www.hcde-texas.org/afterschoolzone).
2. Grantee agrees to meet CASE for Kids quality framework: element one- safe and inclusive environment and element four- collaborative relationships.

## **Program Promotion**

All promotional material or press releases for the project must include the following: County Connections is funded in part by Harris County, and administrated by Harris County Department of Education via CASE for Kids.

Promotional materials or press releases for the project must not include: Logos for Harris County, CASE for Kids, and Harris County Department of Education may not be used in program promotion.

## **Program Compliance & Documentation**

Grantee must adhere to all of the following requirements.

1. Final Report Form – Grantee must provide a final report form that will include a narrative that will highlight the work of the program, challenges, and overall outcome of the program. The final report must also demonstrate how the grantee enhanced program quality during the grant period, as well as provide supporting documentation. Final Report Forms must be submitted to the CASE office, 6005 Westview, Houston, TX 77055 no later than 15 days after the August 15, 2021. To conserve paper, final report and supporting documentation must be submitted items on a flash drive. Files must be in PC format.
2. Student Data Impact- Grantee must utilize the database provided by HCDE to complete attendance information, unless otherwise instructed by CASE for Kids. Grantee will also obtain demographic information through a student registration form that will be provided through the CASE for Kids County Connections Registration Form or approved grantee organization registration form.
3. Proof of expenditures – All expenditures for the awarded amount must be documented.
  - a. Copies of original receipts for expenditures, proof of payroll/professional services, and all other expenses. (Original receipts may be requested upon review of the final report.)
4. Images from project– Eight (8) digital images of the project. Images must be submitted on a USB flash drive in JPG format.
5. Promotional materials – Any materials utilized to promote the County Connections project that include or mention Harris County, CASE for Kids and Harris County Department of Education. Include examples of all promotional materials (press releases, flyers, brochures, etc.).

## **Evaluation**

Grantee may be asked to participate in a more in-depth evaluation of funding impact, which may include site visits, focus groups, and surveys. If selected for this evaluation, Grantee agrees to work with HCDE's Division of Research and Evaluation to ensure the completion of post-project assessments.

Grantee must have an evaluation participation release form signed by a parent/guardian for each student who completes a project survey.

### **Language Assistance**

Grantee must acknowledge, in a form acceptable to HCDE where required by HCDE in a non-discriminatory manner, that it can provide reasonable assistance to non-English speaking participants in its Activity.

### **Insurance**

Grantees must provide proof of insurance, in no less than the amounts detailed in Exhibit "B" attached hereto and made a part hereof.

### **Termination**

If services are not delivered as detailed in this NOGA, the RFP, and/or Grantee's application/proposal, if Grantee does not timely submit a complete final report, if final evaluation by CASE for Kids results in concern over implementation of the project, or if Grantee does not submit evaluation pre/post assessments, the final 20% of the grant award will not be allocated, and Grantee may be required to return part or all of the previously allocated grant funding. Additionally, if Grantee does not adequately document proof of expenses, Grantee may be required to return all or a portion of the grant amount.

### **Indemnity**

**TO THE MAXIMUM EXTENT AUTHORIZED UNDER THE CONSTITUTION AND LAWS OF THE STATE OF TEXAS, GRANTEE WILL HOLD HCDE, ITS OFFICERS, AGENTS, AND EMPLOYEES HARMLESS FROM ANY AND ALL CLAIMS, DEMANDS, DAMAGES, LIABILITIES, AND COSTS WHICH RESULT FROM ANY WILLFUL MISCONDUCT OR NEGLIGENT ACT OR OMISSION OF GRANTEE, ITS OFFICERS, AGENTS, OR EMPLOYEES, PERTAINING TO ITS ACTIVITIES AND OBLIGATIONS UNDER THIS NOGA OR RELATED TO THE COUNTY CONNECTIONS PROGRAM.**

### **Non-Appropriation of Funds**

The term of this NOGA is a commitment of HCDE current revenue only. Notwithstanding anything to the contrary in this NOGA, HCDE's obligation to pay grant funds as stated herein is expressly contingent upon HCDE receiving local, state, and/or federal funds ("funds") for after-school and out-of-school activities that are sufficient to satisfy all obligations to other grantees with which HCDE contracts to provide County Connections projects. In the event HCDE does not receive those funds or sufficient funds, HCDE may terminate this NOGA and will not be responsible for paying Grantee the amount specified herein or for any of the costs of the County Connections program(s) provided by Grantee.

**Governing Law & Venue**

This NOGA shall be governed by and construed in accordance with the laws of the State of Texas, without regard to its conflicts of laws principles. The mandatory and exclusive venue for the adjudication or resolution of any dispute arising out of this NOGA or the County Connections project shall be in Harris County, Texas, and the parties hereby submit to the exclusive jurisdiction of said courts.

**Assignment**

Neither this NOGA nor any duties or obligations outlined in this NOGA shall be assignable by Grantee without the prior written consent of HCDE.

**Relationship**

It is understood and agreed that Grantee is an independent contractor. Nothing in this NOGA shall be interpreted or construed as creating or establishing the relationship of employer and employee between HCDE and any employee or agent of Grantee. The NOGA does not create a joint venture or business partnership under Texas law.

Grantee is solely responsible for the supervision, daily direction and control, payment of salary (including withholding of income taxes and social security), insurance, worker's compensation, and disability benefits and like requirements and obligations of Grantee's employees, agents, volunteers, and representatives.

**Amendment; Entire Agreement**

This NOGA may be amended only by the mutual agreement of the parties, in writing, to be attached to and incorporated in this NOGA.

This Notice of Grant Award ("NOGA"), HCDE's CASE for Kids County Connections Request for Proposals ("RFP"), and Grantee's proposal/application submitted in response to HCDE's RFP, and the attached and incorporated addendum or exhibits, if any, contain the entire agreement of the parties relative to the purpose(s) of the agreement and supercede any other representations, agreements, arrangements, negotiations, or understanding, oral or written, between the parties to this NOGA. In the event of a conflict between this NOGA and the RFP or Grantee's proposal/application submitted in response to the RFP, this NOGA shall control. In the event of a conflict between the RFP and Grantee's proposal/application submitted in response to the RFP, the RFP shall control.

Neither this NOGA, nor any term or provision hereof, nor any inclusion by reference, shall be construed as being for the benefit of any party not in signatory hereto.

Houston Tennis Association

By: *Cheryl Hultquist*  
Cheryl Hultquist (Jun 10, 2021 17:12 CDT)

(Signature)

Cheryl HultQUIST  
3535 BRIARPARK DR. STE. 215,  
Houston, TX 77042  
Phone: 832395-7561  
Email: [cheryl.H@HOUSTONTENNIS.ORG](mailto:cheryl.H@HOUSTONTENNIS.ORG)

Harris County Department of Education

By: \_\_\_\_\_

(Signature)

Dr. Jesus Amezcua  
Assistant Superintendent, Business  
6300 Irvington Blvd.  
Houston, TX 77022-5618  
Phone: 713-696-8249 Fax: 713-696-0740  
Email: [jamezcua@hcde-texas.org](mailto:jamezcua@hcde-texas.org)

## Exhibit B

### GRANTEE INSURANCE REQUIREMENTS

Grantee is required to provide HCDE with copies of certificates of insurance, naming HCDE as an additional insured, for Texas Workman's Compensation and General Liability Insurance. Certificates of Insurance, name and address of Grantee, the limits of liability, the effective dates of each policy, and policy number shall be delivered to HCDE prior to commencement of any work under this Agreement. The insurance company insuring Grantee shall be licensed in the State of Texas and shall be acceptable to HCDE. Grantee shall give HCDE a minimum of ten (10) days' notice prior to any modifications or cancellation of said policies of insurance. Grantee shall require all subcontractors performing any work under or relating to this Agreement to maintain coverage as specified below.

Minimum Insurance Requirements:

- Grantee shall, at all times during the Term of this Agreement, maintain insurance coverage with not less than the type and requirements shown below. Such insurance is to be provided at the sole cost of Grantee. These requirements do not establish limits of Grantees's liability.
  - All policies of insurance shall waive all rights of subrogation against HCDE, its officers, employees, and agents.
  - Upon request, certified copies of original insurance policies shall be furnished to HCDE.
  - HCDE shall be named as an "additional insured" on all insurance policies.
  - HCDE reserves the right to require additional insurance should HCDE deem additional insurance necessary, in HCDE's sole discretion.
- A. Workers' Compensation (with Waiver of subrogation to HCDE) Employer's Liability, including all states, U.S. Longshoremen, Harbor Workers and other endorsements.
- B. Statutory, and Bodily Injury by Accident: \$100,000 each employee. Bodily Injury by Disease: \$500,000, policy limit \$100,000 each employee. Commercial General Liability Occurrence Form including, but not limited to, Premises and Operations, Products Liability Broad Form Property Damage, Contractual Liability, Personal and Advertising Injury Liability and where the exposure exists, coverage for watercraft, blasting collapse, and explosions, blowout, catering and underground damage.
- \$300,000 each occurrence Limit Bodily Injury and Property Damage combined
  - \$300,000 Products-Completed Operations Aggregate Limit \$500,000 per Job Aggregate
  - \$300,000 Personal and Advertising Injury Limit
- C. Automobile Liability Coverage  
\$300,000 Combined Liability Limits Bodily Injury and Property Damage Combined

In the event the above-detailed insurance requirements require modifications after the NOGA is executed, as determined by HCDE in its sole discretion, HCDE reserves the right to amend this Exhibit B to the NOGA, with such modifications to be effective upon written notice to Grantee, and Grantee agrees to comply with such modified requirements. Grantee acknowledges and agrees that continued payment by HCDE to Grantee under the NOGA is adequate consideration for agreeing to comply with the required insurance requirements, as modified. In the event such modified requirements are required, HCDE and Grantee agree that a formal amendment to the NOGA is not required, but the modified insurance requirements shall become effective upon written notice to Grantee.

\*\*\*\*\*NOTICE OF GRANT AWARD\*\*\*\*\*

Project Title: CASE for Kids County Connections Youth Summer Initiative 2021  
Grant Term: June 14, 2021 – August 15, 2021  
Center for Afterschool, Summer, and Enrichment for Kids (CASE for Kids)  
Harris County Department of Education

\*\*\*\*\*

Houston Tennis Association  
Cheryl Hultquist  
3535 BRIARPARK DR. STE. 215, Houston, TX 77042

Dear Houston Tennis Association,

The Harris County Department of Education (“HCDE”) hereby awards a grant in the amount of \$12,800 to Houston Tennis Association (“Grantee”) in support of the above-referenced project. This award is subject to the terms and conditions specified herein (the “NOGA”) and in HCDE’s CASE for Kids County Connections Request for Proposals (“RFP”). Acceptance of this award, including the terms and conditions detailed in this NOGA, is acknowledged by the Grantee by returning (1) one signed original to HCDE CASE for Kids, no later than June 11, 2021.

In consideration of the mutual covenants and conditions contained in this Notice of Grant Award (“NOGA”) and other good and valuable consideration, the receipt and sufficiency of which are hereby acknowledged, the parties, intending to be legally bound, agree as follows:

**Program Description**

*Through County Connections, grant funding will support the expansion of the free youth tennis program at neighborhood sites throughout greater Houston. Conducted in a manner with social equity in mind, locations penetrate areas where tennis has never been offered before reaching diverse communities of varying ethniCounty and socioeconomic levels. Students receive information about art, writing and reading contests available through NJTL and may participate in a Team Challenge if/when their tennis skills are ready.*

CASE for Kids County Connections Site(s):

- Charlton Park***
- Meadowcreek Park***
- Montie Beach Park***
- Moody Park***
- Wilson Memorial Park***
- Woodland Park***
- Mason Park***

- Dow Park***
- Freeway Manor Park***
- Greenwood Park***
- Hartman Park***
- Keith-Weiss Park***
- Settegast Park***

**Term**



Grantee must start programming on or after June 14, 2021 and end programming no later than August 15, 2021. Your grant application proposed the dates and times described on the CASE for Kids County Connections Proposed Site List. Changes to program dates or times must be submitted in writing to HCDE’s CASE division and approved by CASE in advance.

**Compensation**

Upon return of (1) one signed original of the Notice of Grant Award, Grantee must submit an invoice for 80% of the grant award for payment. The final 20% of the grant award will be paid upon receipt and approval of an invoice, documentation of expenditures, and the final report as outlined below.

Grantee shall match the total amount of program grant funding on a dollar-for-dollar basis. The match may be cash or in-kind support from other sources. Grantee shall maintain sufficient documentation of its match and produce said documentation to HCDE upon request.

Grantee agrees to expend grant funding to support the proposed project, as described, to provide service for the Harris County Precinct and its constituents.

Grantee is required to submit original invoices to the HCDE Business Office ATTN: Accounts Payable. The invoices can be mailed through the postal service to HCDE Business Office ATTN: Accounts Payable 6300 Irvington Boulevard Houston, Texas 77022 or emailed to [accountspayable@hcde-texas.org](mailto:accountspayable@hcde-texas.org).

The invoice should include the following:

1. Date of invoice
2. Period of service (i.e. month of)
3. Invoice Number
4. Contact Information
5. Deliverables under the contract: CASE for Kids County Connections 2021
6. Certification of service provided through a signature by company representative.

Budget Period 2020-2021	
Project Administration	\$390
Program Quality Improvement	\$190
Payroll & Staff	\$6,840
Professional Service	\$190
Supplies and Materials	\$4,680
Events	\$
Buses/Mileage	\$
Scholarship/Discounted Fees	\$250
Miscellaneous	\$260
<b>Total Budget: \$12,800</b>	

**Grantee’s Requirements**

1. Grant recipients must meet the following requirements, according to the schedule and deadlines set by HCDE:

- a. Grantees shall maintain all records and accounts in a manner that shall assure full accounting of all expenditures paid for with both funds received from HCDE and local site matching funds relating to the signed Notice of Grant Award (NOGA). Grantee records and accounts shall be retained by the grantee and made available for audit by HCDE, Harris County, or their respective representatives for a period of not less than three (3) years after the expiration or termination of the NOGA. If an audit has been announced, the grantee shall retain its records and accounts until such audit has been completed.
  - b. Grantee shall comply with all applicable federal, state, and municipal laws, ordinances, rules, and regulations and certify such compliance upon request.
  - c. Complete a final report at the end of the program period, including but not limited to attendance forms and a project summary form provided by CASE for Kids detailing project accomplishments and challenges, photo documentation of the project, and promotional materials.
  - d. Submit attendance and demographics for youth served with program grant funding, in the manner required by HCDE.
  - e. Comply with evaluations required by HCDE, which may include site visits, focus groups, and surveys.
  - f. Agree to obtain and assess criminal history record information for each employee, contractor, or volunteer used in the delivery of projects funded by program grant funds and to use only those persons fit to work with students.
  - g. Submit an HCDE vendor packet to include, at a minimum, the following: W-9 Form, Conflict of Interest Form, Felony Conviction Affidavit Form, and Covered Employee Affidavit Form.
  - h. Staff members of the funded organization are eligible to attend the CASE for Kids free Afterschool Community Training Series.
  - i. Awarded organizations are required to attend two (2) mandatory meetings presented by CASE for Kids staff during the grant term on topics related to grant compliance, funding and resources on program implementation. The mandatory workshop schedule and details will be emailed to grantees.
  - j. Provides a safe and inclusive environment for youth. See details on [www.hcde-texas.org/afterschoolzone](http://www.hcde-texas.org/afterschoolzone).
2. Grantee agrees to meet CASE for Kids quality framework: element one- safe and inclusive environment and element four- collaborative relationships.

## **Program Promotion**

All promotional material or press releases for the project must include the following: County Connections is funded in part by Harris County, and administrated by Harris County Department of Education via CASE for Kids.

Promotional materials or press releases for the project must not include: Logos for Harris County, CASE for Kids, and Harris County Department of Education may not be used in program promotion.

## **Program Compliance & Documentation**

Grantee must adhere to all of the following requirements.

1. Final Report Form – Grantee must provide a final report form that will include a narrative that will highlight the work of the program, challenges, and overall outcome of the program. The final report must also demonstrate how the grantee enhanced program quality during the grant period, as well as provide supporting documentation. Final Report Forms must be submitted to the CASE office, 6005 Westview, Houston, TX 77055 no later than 15 days after the August 15, 2021. To conserve paper, final report and supporting documentation must be submitted items on a flash drive. Files must be in PC format.
2. Student Data Impact- Grantee must utilize the database provided by HCDE to complete attendance information, unless otherwise instructed by CASE for Kids. Grantee will also obtain demographic information through a student registration form that will be provided through the CASE for Kids County Connections Registration Form or approved grantee organization registration form.
3. Proof of expenditures – All expenditures for the awarded amount must be documented.
  - a. Copies of original receipts for expenditures, proof of payroll/professional services, and all other expenses. (Original receipts may be requested upon review of the final report.)
4. Images from project– Eight (8) digital images of the project. Images must be submitted on a USB flash drive in JPG format.
5. Promotional materials – Any materials utilized to promote the County Connections project that include or mention Harris County, CASE for Kids and Harris County Department of Education. Include examples of all promotional materials (press releases, flyers, brochures, etc.).

## **Evaluation**

Grantee may be asked to participate in a more in-depth evaluation of funding impact, which may include site visits, focus groups, and surveys. If selected for this evaluation, Grantee agrees to work with HCDE's Division of Research and Evaluation to ensure the completion of post-project assessments.

Grantee must have an evaluation participation release form signed by a parent/guardian for each student who completes a project survey.

### **Language Assistance**

Grantee must acknowledge, in a form acceptable to HCDE where required by HCDE in a non-discriminatory manner, that it can provide reasonable assistance to non-English speaking participants in its Activity.

### **Insurance**

Grantees must provide proof of insurance, in no less than the amounts detailed in Exhibit "B" attached hereto and made a part hereof.

### **Termination**

If services are not delivered as detailed in this NOGA, the RFP, and/or Grantee's application/proposal, if Grantee does not timely submit a complete final report, if final evaluation by CASE for Kids results in concern over implementation of the project, or if Grantee does not submit evaluation pre/post assessments, the final 20% of the grant award will not be allocated, and Grantee may be required to return part or all of the previously allocated grant funding. Additionally, if Grantee does not adequately document proof of expenses, Grantee may be required to return all or a portion of the grant amount.

### **Indemnity**

**TO THE MAXIMUM EXTENT AUTHORIZED UNDER THE CONSTITUTION AND LAWS OF THE STATE OF TEXAS, GRANTEE WILL HOLD HCDE, ITS OFFICERS, AGENTS, AND EMPLOYEES HARMLESS FROM ANY AND ALL CLAIMS, DEMANDS, DAMAGES, LIABILITIES, AND COSTS WHICH RESULT FROM ANY WILLFUL MISCONDUCT OR NEGLIGENT ACT OR OMISSION OF GRANTEE, ITS OFFICERS, AGENTS, OR EMPLOYEES, PERTAINING TO ITS ACTIVITIES AND OBLIGATIONS UNDER THIS NOGA OR RELATED TO THE COUNTY CONNECTIONS PROGRAM.**

### **Non-Appropriation of Funds**

The term of this NOGA is a commitment of HCDE current revenue only. Notwithstanding anything to the contrary in this NOGA, HCDE's obligation to pay grant funds as stated herein is expressly contingent upon HCDE receiving local, state, and/or federal funds ("funds") for after-school and out-of-school activities that are sufficient to satisfy all obligations to other grantees with which HCDE contracts to provide County Connections projects. In the event HCDE does not receive those funds or sufficient funds, HCDE may terminate this NOGA and will not be responsible for paying Grantee the amount specified herein or for any of the costs of the County Connections program(s) provided by Grantee.

**Governing Law & Venue**

This NOGA shall be governed by and construed in accordance with the laws of the State of Texas, without regard to its conflicts of laws principles. The mandatory and exclusive venue for the adjudication or resolution of any dispute arising out of this NOGA or the County Connections project shall be in Harris County, Texas, and the parties hereby submit to the exclusive jurisdiction of said courts.

**Assignment**

Neither this NOGA nor any duties or obligations outlined in this NOGA shall be assignable by Grantee without the prior written consent of HCDE.

**Relationship**

It is understood and agreed that Grantee is an independent contractor. Nothing in this NOGA shall be interpreted or construed as creating or establishing the relationship of employer and employee between HCDE and any employee or agent of Grantee. The NOGA does not create a joint venture or business partnership under Texas law.

Grantee is solely responsible for the supervision, daily direction and control, payment of salary (including withholding of income taxes and social security), insurance, worker's compensation, and disability benefits and like requirements and obligations of Grantee's employees, agents, volunteers, and representatives.

**Amendment; Entire Agreement**

This NOGA may be amended only by the mutual agreement of the parties, in writing, to be attached to and incorporated in this NOGA.

This Notice of Grant Award ("NOGA"), HCDE's CASE for Kids County Connections Request for Proposals ("RFP"), and Grantee's proposal/application submitted in response to HCDE's RFP, and the attached and incorporated addendum or exhibits, if any, contain the entire agreement of the parties relative to the purpose(s) of the agreement and supercede any other representations, agreements, arrangements, negotiations, or understanding, oral or written, between the parties to this NOGA. In the event of a conflict between this NOGA and the RFP or Grantee's proposal/application submitted in response to the RFP, this NOGA shall control. In the event of a conflict between the RFP and Grantee's proposal/application submitted in response to the RFP, the RFP shall control.

Neither this NOGA, nor any term or provision hereof, nor any inclusion by reference, shall be construed as being for the benefit of any party not in signatory hereto.

Houston Tennis Association

By: *Cheryl Hultquist*  
Cheryl Hultquist (Jun 10, 2021 17:15 CDT)

(Signature)

Cheryl Hultquist  
3535 BRIARPARK DR. STE. 215,  
Houston, TX 77042  
Phone: 832395-7561  
Email: [cheryl.H@HOUSTONTENNIS.ORG](mailto:cheryl.H@HOUSTONTENNIS.ORG)  
G

Harris County Department of Education

By: \_\_\_\_\_

(Signature)

Dr. Jesus Amezcua  
Assistant Superintendent, Business  
6300 Irvington Blvd.  
Houston, TX 77022-5618  
Phone: 713-696-8249 Fax: 713-696-0740  
Email: [jamezcua@hcde-texas.org](mailto:jamezcua@hcde-texas.org)

## Exhibit B

### GRANTEE INSURANCE REQUIREMENTS

Grantee is required to provide HCDE with copies of certificates of insurance, naming HCDE as an additional insured, for Texas Workman's Compensation and General Liability Insurance. Certificates of Insurance, name and address of Grantee, the limits of liability, the effective dates of each policy, and policy number shall be delivered to HCDE prior to commencement of any work under this Agreement. The insurance company insuring Grantee shall be licensed in the State of Texas and shall be acceptable to HCDE. Grantee shall give HCDE a minimum of ten (10) days' notice prior to any modifications or cancellation of said policies of insurance. Grantee shall require all subcontractors performing any work under or relating to this Agreement to maintain coverage as specified below.

Minimum Insurance Requirements:

- Grantee shall, at all times during the Term of this Agreement, maintain insurance coverage with not less than the type and requirements shown below. Such insurance is to be provided at the sole cost of Grantee. These requirements do not establish limits of Grantees's liability.
  - All policies of insurance shall waive all rights of subrogation against HCDE, its officers, employees, and agents.
  - Upon request, certified copies of original insurance policies shall be furnished to HCDE.
  - HCDE shall be named as an "additional insured" on all insurance policies.
  - HCDE reserves the right to require additional insurance should HCDE deem additional insurance necessary, in HCDE's sole discretion.
- A. Workers' Compensation (with Waiver of subrogation to HCDE) Employer's Liability, including all states, U.S. Longshoremen, Harbor Workers and other endorsements.
- B. Statutory, and Bodily Injury by Accident: \$100,000 each employee. Bodily Injury by Disease: \$500,000, policy limit \$100,000 each employee. Commercial General Liability Occurrence Form including, but not limited to, Premises and Operations, Products Liability Broad Form Property Damage, Contractual Liability, Personal and Advertising Injury Liability and where the exposure exists, coverage for watercraft, blasting collapse, and explosions, blowout, catering and underground damage.
- \$300,000 each occurrence Limit Bodily Injury and Property Damage combined
  - \$300,000 Products-Completed Operations Aggregate Limit \$500,000 per Job Aggregate
  - \$300,000 Personal and Advertising Injury Limit
- C. Automobile Liability Coverage  
\$300,000 Combined Liability Limits Bodily Injury and Property Damage Combined

In the event the above-detailed insurance requirements require modifications after the NOGA is executed, as determined by HCDE in its sole discretion, HCDE reserves the right to amend this Exhibit B to the NOGA, with such modifications to be effective upon written notice to Grantee, and Grantee agrees to comply with such modified requirements. Grantee acknowledges and agrees that continued payment by HCDE to Grantee under the NOGA is adequate consideration for agreeing to comply with the required insurance requirements, as modified. In the event such modified requirements are required, HCDE and Grantee agree that a formal amendment to the NOGA is not required, but the modified insurance requirements shall become effective upon written notice to Grantee.

\*\*\*\*\*NOTICE OF GRANT AWARD\*\*\*\*\*

Project Title: CASE for Kids County Connections Youth Summer Initiative 2021  
Grant Term: June 14, 2021 – August 15, 2021  
Center for Afterschool, Summer, and Enrichment for Kids (CASE for Kids)  
Harris County Department of Education

\*\*\*\*\*

Houston Tennis Association  
CHERYL HULTQUIST  
3535 BRIARPARK DR. STE. 215, Houston, TX 77042

Dear Houston Tennis Association,

The Harris County Department of Education (“HCDE”) hereby awards a grant in the amount of \$9,700 to Houston Tennis Association (“Grantee”) in support of the above-referenced project. This award is subject to the terms and conditions specified herein (the “NOGA”) and in HCDE’s CASE for Kids County Connections Request for Proposals (“RFP”). Acceptance of this award, including the terms and conditions detailed in this NOGA, is acknowledged by the Grantee by returning (1) one signed original to HCDE CASE for Kids, no later than June 11, 2021.

In consideration of the mutual covenants and conditions contained in this Notice of Grant Award (“NOGA”) and other good and valuable consideration, the receipt and sufficiency of which are hereby acknowledged, the parties, intending to be legally bound, agree as follows:

**Program Description**

*The Houston Tennis Association is to encourage and promote tennis Houston regardless of age, gender, disability or level of play. Our ultimate goal is to support and foster good health and sportsmanship through tennis, the sport of a lifetime. HTA NJTL (National Junior Tennis and Learning) focuses on youth development through tennis, education and scholarship programs serving 45+ neighborhood parks and schools each year. Conducted in a manner with social equity in mind, locations penetrate areas of where tennis has never been offered before reaching diverse communities of varying ethniCounty and socioeconomic levels.*

**CASE for Kids County Connections Site(s):**

HUTCHESON PARK  
PLATOU PARK  
SAGEMONT PARK  
SUNNYSIDE PARK  
TIDWELL PARK  
WESTWOOD PARK  
CLINTON PARK  
FINNIGAN PARK

HAVILAND PARK  
HIGHLAND PARK  
WINDSOR VILLAGE PARK  
CLEVELAND PARK  
CRESTMONT PARK  
DODSON LAKE PARK  
MELROSE PARK  
SCENIC WOODS PARK



**Term**

Grantee must start programming on or after June 14, 2021 and end programming no later than August 15, 2021. Your grant application proposed the dates and times described on the CASE for Kids County Connections Proposed Site List. Changes to program dates or times must be submitted in writing to HCDE’s CASE division and approved by CASE in advance.

**Compensation**

Upon return of (1) one signed original of the Notice of Grant Award, Grantee must submit an invoice for 80% of the grant award for payment. The final 20% of the grant award will be paid upon receipt and approval of an invoice, documentation of expenditures, and the final report as outlined below.

Grantee shall match the total amount of program grant funding on a dollar-for-dollar basis. The match may be cash or in-kind support from other sources. Grantee shall maintain sufficient documentation of its match and produce said documentation to HCDE upon request.

Grantee agrees to expend grant funding to support the proposed project, as described, to provide service for the Harris County Precinct and its constituents.

Grantee is required to submit original invoices to the HCDE Business Office ATTN: Accounts Payable. The invoices can be mailed through the postal service to HCDE Business Office ATTN: Accounts Payable 6300 Irvington Boulevard Houston, Texas 77022 or emailed to [accountspayable@hcde-texas.org](mailto:accountspayable@hcde-texas.org).

The invoice should include the following:

1. Date of invoice
2. Period of service (i.e. month of)
3. Invoice Number
4. Contact Information
5. Deliverables under the contract: CASE for Kids County Connections 2021
6. Certification of service provided through a signature by company representative.

Budget Period 2020-2021	
Project Administration	\$700
Program Quality Improvement	
Payroll & Staff	\$8,000
Professional Service	
Supplies and Materials	\$1,000
Events	
Buses/Mileage	
Scholarship/Discounted Fees	
Miscellaneous	
<b>Total Budget: \$9,700</b>	

## Grantee's Requirements

1. Grant recipients must meet the following requirements, according to the schedule and deadlines set by HCDE:
  - a. Grantees shall maintain all records and accounts in a manner that shall assure full accounting of all expenditures paid for with both funds received from HCDE and local site matching funds relating to the signed Notice of Grant Award (NOGA). Grantee records and accounts shall be retained by the grantee and made available for audit by HCDE, Harris County, or their respective representatives for a period of not less than three (3) years after the expiration or termination of the NOGA. If an audit has been announced, the grantee shall retain its records and accounts until such audit has been completed.
  - b. Grantee shall comply with all applicable federal, state, and municipal laws, ordinances, rules, and regulations and certify such compliance upon request.
  - c. Complete a final report at the end of the program period, including but not limited to attendance forms and a project summary form provided by CASE for Kids detailing project accomplishments and challenges, photo documentation of the project, and promotional materials.
  - d. Submit attendance and demographics for youth served with program grant funding, in the manner required by HCDE.
  - e. Comply with evaluations required by HCDE, which may include site visits, focus groups, and surveys.
  - f. Agree to obtain and assess criminal history record information for each employee, contractor, or volunteer used in the delivery of projects funded by program grant funds and to use only those persons fit to work with students.
  - g. Submit an HCDE vendor packet to include, at a minimum, the following: W-9 Form, Conflict of Interest Form, Felony Conviction Affidavit Form, and Covered Employee Affidavit Form.
  - h. Staff members of the funded organization are eligible to attend the CASE for Kids free Afterschool Community Training Series.
  - i. Awarded organizations are required to attend two (2) mandatory meetings presented by CASE for Kids staff during the grant term on topics related to grant compliance, funding and resources on program implementation. The mandatory workshop schedule and details will be emailed to grantees.
  - j. Provides a safe and inclusive environment for youth. See details on [www.hcde-texas.org/afterschoolzone](http://www.hcde-texas.org/afterschoolzone).

2. Grantee agrees to meet CASE for Kids quality framework: element one- safe and inclusive environment and element four- collaborative relationships.

### **Program Promotion**

All promotional material or press releases for the project must include the following: County Connections is funded in part by Harris County, and administrated by Harris County Department of Education via CASE for Kids.

Promotional materials or press releases for the project must not include: Logos for Harris County, CASE for Kids, and Harris County Department of Education may not be used in program promotion.

### **Program Compliance & Documentation**

Grantee must adhere to all of the following requirements.

1. Final Report Form – Grantee must provide a final report form that will include a narrative that will highlight the work of the program, challenges, and overall outcome of the program. The final report must also demonstrate how the grantee enhanced program quality during the grant period, as well as provide supporting documentation. Final Report Forms must be submitted to the CASE office, 6005 Westview, Houston, TX 77055 no later than 15 days after the August 15, 2021. To conserve paper, final report and supporting documentation must be submitted items on a flash drive. Files must be in PC format.
2. Student Data Impact- Grantee must utilize the database provided by HCDE to complete attendance information, unless otherwise instructed by CASE for Kids. Grantee will also obtain demographic information through a student registration form that will be provided through the CASE for Kids County Connections Registration Form or approved grantee organization registration form.
3. Proof of expenditures – All expenditures for the awarded amount must be documented.
  - a. Copies of original receipts for expenditures, proof of payroll/professional services, and all other expenses. (Original receipts may be requested upon review of the final report.)
4. Images from project– Eight (8) digital images of the project. Images must be submitted on a USB flash drive in JPG format.
5. Promotional materials – Any materials utilized to promote the County Connections project that include or mention Harris County, CASE for Kids and Harris County Department of Education. Include examples of all promotional materials (press releases, flyers, brochures, etc.).

### **Evaluation**

Grantee may be asked to participate in a more in-depth evaluation of funding impact, which may include site visits, focus groups, and surveys. If selected for this evaluation, Grantee agrees to work with HCDE's Division of Research and Evaluation to ensure the completion of post-project assessments.

Grantee must have an evaluation participation release form signed by a parent/guardian for each student who completes a project survey.

### **Language Assistance**

Grantee must acknowledge, in a form acceptable to HCDE where required by HCDE in a non-discriminatory manner, that it can provide reasonable assistance to non-English speaking participants in its Activity.

### **Insurance**

Grantees must provide proof of insurance, in no less than the amounts detailed in Exhibit "B" attached hereto and made a part hereof.

### **Termination**

If services are not delivered as detailed in this NOGA, the RFP, and/or Grantee's application/proposal, if Grantee does not timely submit a complete final report, if final evaluation by CASE for Kids results in concern over implementation of the project, or if Grantee does not submit evaluation pre/post assessments, the final 20% of the grant award will not be allocated, and Grantee may be required to return part or all of the previously allocated grant funding. Additionally, if Grantee does not adequately document proof of expenses, Grantee may be required to return all or a portion of the grant amount.

### **Indemnity**

**TO THE MAXIMUM EXTENT AUTHORIZED UNDER THE CONSTITUTION AND LAWS OF THE STATE OF TEXAS, GRANTEE WILL HOLD HCDE, ITS OFFICERS, AGENTS, AND EMPLOYEES HARMLESS FROM ANY AND ALL CLAIMS, DEMANDS, DAMAGES, LIABILITIES, AND COSTS WHICH RESULT FROM ANY WILLFUL MISCONDUCT OR NEGLIGENT ACT OR OMISSION OF GRANTEE, ITS OFFICERS, AGENTS, OR EMPLOYEES, PERTAINING TO ITS ACTIVITIES AND OBLIGATIONS UNDER THIS NOGA OR RELATED TO THE COUNTY CONNECTIONS PROGRAM.**

### **Non-Appropriation of Funds**

The term of this NOGA is a commitment of HCDE current revenue only. Notwithstanding anything to the contrary in this NOGA, HCDE's obligation to pay grant funds as stated herein is expressly contingent upon HCDE receiving local, state, and/or federal funds ("funds") for after-school and out-of-school activities that are sufficient to satisfy all obligations to other grantees with which HCDE contracts to provide County Connections projects. In the event HCDE does

not receive those funds or sufficient funds, HCDE may terminate this NOGA and will not be responsible for paying Grantee the amount specified herein or for any of the costs of the County Connections program(s) provided by Grantee.

### **Governing Law & Venue**

This NOGA shall be governed by and construed in accordance with the laws of the State of Texas, without regard to its conflicts of laws principles. The mandatory and exclusive venue for the adjudication or resolution of any dispute arising out of this NOGA or the County Connections project shall be in Harris County, Texas, and the parties hereby submit to the exclusive jurisdiction of said courts.

### **Assignment**

Neither this NOGA nor any duties or obligations outlined in this NOGA shall be assignable by Grantee without the prior written consent of HCDE.

### **Relationship**

It is understood and agreed that Grantee is an independent contractor. Nothing in this NOGA shall be interpreted or construed as creating or establishing the relationship of employer and employee between HCDE and any employee or agent of Grantee. The NOGA does not create a joint venture or business partnership under Texas law.

Grantee is solely responsible for the supervision, daily direction and control, payment of salary (including withholding of income taxes and social security), insurance, worker's compensation, and disability benefits and like requirements and obligations of Grantee's employees, agents, volunteers, and representatives.

### **Amendment; Entire Agreement**

This NOGA may be amended only by the mutual agreement of the parties, in writing, to be attached to and incorporated in this NOGA.

This Notice of Grant Award ("NOGA"), HCDE's CASE for Kids County Connections Request for Proposals ("RFP"), and Grantee's proposal/application submitted in response to HCDE's RFP, and the attached and incorporated addendum or exhibits, if any, contain the entire agreement of the parties relative to the purpose(s) of the agreement and supersede any other representations, agreements, arrangements, negotiations, or understanding, oral or written, between the parties to this NOGA. In the event of a conflict between this NOGA and the RFP or Grantee's proposal/application submitted in response to the RFP, this NOGA shall control. In the event of a conflict between the RFP and Grantee's proposal/application submitted in response to the RFP, the RFP shall control.

Neither this NOGA, nor any term or provision hereof, nor any inclusion by reference, shall be construed as being for the benefit of any party not in signatory hereto.

Houston Tennis Association

By: *Cheryl Hultquist*  
Cheryl Hultquist (Jun 10, 2021 15:22 CDT)

(Signature)

CHERYL HULTQUIST  
3535 BRIARPARK DR. STE. 215,  
Houston, TX 77042  
Phone: 832-395-7561  
Email: [CHERYL.H@HOUSTONTENNIS.ORG](mailto:CHERYL.H@HOUSTONTENNIS.ORG)  
RG

Harris County Department of Education

By: \_\_\_\_\_

(Signature)

Dr. Jesus Amezcua  
Assistant Superintendent, Business  
6300 Irvington Blvd.  
Houston, TX 77022-5618  
Phone: 713-696-8249 Fax: 713-696-0740  
Email: [jamezcua@hcde-texas.org](mailto:jamezcua@hcde-texas.org)

## Exhibit B

### GRANTEE INSURANCE REQUIREMENTS

Grantee is required to provide HCDE with copies of certificates of insurance, naming HCDE as an additional insured, for Texas Workman's Compensation and General Liability Insurance. Certificates of Insurance, name and address of Grantee, the limits of liability, the effective dates of each policy, and policy number shall be delivered to HCDE prior to commencement of any work under this Agreement. The insurance company insuring Grantee shall be licensed in the State of Texas and shall be acceptable to HCDE. Grantee shall give HCDE a minimum of ten (10) days' notice prior to any modifications or cancellation of said policies of insurance. Grantee shall require all subcontractors performing any work under or relating to this Agreement to maintain coverage as specified below.

Minimum Insurance Requirements:

- Grantee shall, at all times during the Term of this Agreement, maintain insurance coverage with not less than the type and requirements shown below. Such insurance is to be provided at the sole cost of Grantee. These requirements do not establish limits of Grantees's liability.
  - All policies of insurance shall waive all rights of subrogation against HCDE, its officers, employees, and agents.
  - Upon request, certified copies of original insurance policies shall be furnished to HCDE.
  - HCDE shall be named as an "additional insured" on all insurance policies.
  - HCDE reserves the right to require additional insurance should HCDE deem additional insurance necessary, in HCDE's sole discretion.
- A. Workers' Compensation (with Waiver of subrogation to HCDE) Employer's Liability, including all states, U.S. Longshoremen, Harbor Workers and other endorsements.
- B. Statutory, and Bodily Injury by Accident: \$100,000 each employee. Bodily Injury by Disease: \$500,000, policy limit \$100,000 each employee. Commercial General Liability Occurrence Form including, but not limited to, Premises and Operations, Products Liability Broad Form Property Damage, Contractual Liability, Personal and Advertising Injury Liability and where the exposure exists, coverage for watercraft, blasting collapse, and explosions, blowout, catering and underground damage.
- \$300,000 each occurrence Limit Bodily Injury and Property Damage combined
  - \$300,000 Products-Completed Operations Aggregate Limit \$500,000 per Job Aggregate
  - \$300,000 Personal and Advertising Injury Limit
- C. Automobile Liability Coverage  
\$300,000 Combined Liability Limits Bodily Injury and Property Damage Combined

In the event the above-detailed insurance requirements require modifications after the NOGA is executed, as determined by HCDE in its sole discretion, HCDE reserves the right to amend this Exhibit B to the NOGA, with such modifications to be effective upon written notice to Grantee, and Grantee agrees to comply with such modified requirements. Grantee acknowledges and agrees that continued payment by HCDE to Grantee under the NOGA is adequate consideration for agreeing to comply with the required insurance requirements, as modified. In the event such modified requirements are required, HCDE and Grantee agree that a formal amendment to the NOGA is not required, but the modified insurance requirements shall become effective upon written notice to Grantee.

**Regular Board Meeting**

**8.D.10.**

<b>Meeting Date:</b>	July 21, 2021		
<b>Title:</b>	Service Agreement with MECA for CASE for Kids County Connections		
<b>Submitted For:</b>	Lisa Caruthers, Case for Kids	<b>Submitted By:</b>	Kimberlee Flowers
<b>Recommended Action:</b>	Approve	<b>HCDE Goal(s):</b>	1. Impact education/respond to evolving needs 2. Deliver value responsibly 3. Advocate for learners through innovation
<b>Additional Resource Personnel:</b>	Danielle Bartz, Dr. Lisa Caruthers, Dr. Jesus Amezcua, Bill Monroe, Kendra Jackson	<b>Facilities/Technology Approval Needed?:</b>	

**Information**

**Posted Agenda Item:**

**Ratification of award RFP#21/044KJ for County Connections-Youth Summer Initiative and Approve aggregate expenditures of \$81,100 from CASE for Kids to Multicultural Counseling and Education for the Arts (MECA) per CH Local FY21:** County Connections’ grant award (Expenditure Contracts) totaling \$20,000 for MECA Dow School for Summer 2021 programming is in addition to prior awards of \$40,000 in Partnership Project, \$5,000 in City Connections, and \$16,100 in Select Services. County Connections will increase number of students served, number of sites served and/or timeframe in which students are served.

**Subject:**

Service Agreement (Expenditure) with Multicultural Counseling and Education for the Arts (MECA) for CASE for Kids County Connections-Youth Summer Initiative

**Rationale:**

County Connections Youth Summer Initiative 2021, funded directly by Harris County, supports nonprofit organizations that address the need for youth services during the summer. Initiatives funded by the CASE for Kids County Connections program can provide comprehensive summer programs, short term projects and summer camps hosted in-person or virtually from a variety of locations including schools, community centers, apartment complexes and churches. Initiatives are customized to meet community needs of individual Harris County Precincts. Services must include resources or reduce cost for summer initiatives for families during pandemic conditions.

MECA will receive \$20,000 in funding for MECA Dow School to serve 140 students in Precinct 2. This service agreement is in addition to a prior Partnership Project grant award for \$40,000 to serve 170 students at MECA Dow School and for MECA TBH Center to serve 170 students; a prior grant award for \$5,000 for MECA through City Connections, serving 117 students for MECA Dow School and MECA TBH Center in City Council District H, and a prior expenditure contract of \$16,100 to serve 200 students at 8 CASE for Kids 21CCLC sites and Partnership Project sites for the aggregate amount of \$81,100 in awards from CASE for Kids.



\*\*\*\*\*NOTICE OF GRANT AWARD\*\*\*\*\*

Project Title: CASE for Kids County Connections Youth Summer Initiative 2021  
Grant Term: June 14, 2021 – August 15, 2021  
Center for Afterschool, Summer, and Enrichment for Kids (CASE for Kids)  
Harris County Department of Education

\*\*\*\*\*

Multicultural Education and Counseling through the Arts  
Alice Valdez  
1900 Kane Street, Houston, TX 77007

Dear Multicultural Education and Counseling through the Arts,

The Harris County Department of Education (“HCDE”) hereby awards a grant in the amount of \$20,000 to Multicultural Education and Counseling through the Arts (“Grantee”) in support of the above-referenced project. This award is subject to the terms and conditions specified herein (the “NOGA”) and in HCDE’s CASE for Kids County Connections Request for Proposals (“RFP”). Acceptance of this award, including the terms and conditions detailed in this NOGA, is acknowledged by the Grantee by returning (1) one signed original to HCDE CASE for Kids, no later than June 11, 2021.

In consideration of the mutual covenants and conditions contained in this Notice of Grant Award (“NOGA”) and other good and valuable consideration, the receipt and sufficiency of which are hereby acknowledged, the parties, intending to be legally bound, agree as follows:

**Program Description**

*MECA’s 2021 Sunburst Summer Arts Camp will offer students the opportunity to participate in an all day, in person arts and enrichment camp at MECA’s main campus in the Historic Dow School. The program will offer visual, cultural and classical arts education, theater, spoken word and creative writing to approximately 140 at risk students. In 2021, MECA is offering a special collaboration within the summer program between MECA and the Community Music Center of Houston (CMCH) to celebrate and honor the history of Juneteenth. The primary goal of the project’s collaboration is intended to bring awareness and even current social context of the enormous influence of African music on Latin music and dance. MECA and CMCH each serve principally unique communities. CMCH serves as a predominant African American music center whereas MECA principally serves the Latino community. The unique pairing, specifically by showcasing the cultural similarities, will provide the opportunity to act as a bridge between these two communities, thereby providing a natural invitation to bring them closer together.*

CASE for Kids County Connections Site(s): **DOW SCHOOL**

**Term**

Grantee must start programming on or after June 14, 2021 and end programming no later than August 15, 2021. Your grant application proposed the dates and times described on the CASE for Kids County Connections Proposed Site List. Changes to program dates or times must be submitted in writing to HCDE’s CASE division and approved by CASE in advance.

**Compensation**

Upon return of (1) one signed original of the Notice of Grant Award, Grantee must submit an invoice for 80% of the grant award for payment. The final 20% of the grant award will be paid upon receipt and approval of an invoice, documentation of expenditures, and the final report as outlined below.

Grantee shall match the total amount of program grant funding on a dollar-for-dollar basis. The match may be cash or in-kind support from other sources. Grantee shall maintain sufficient documentation of its match and produce said documentation to HCDE upon request.

Grantee agrees to expend grant funding to support the proposed project, as described, to provide service for the Harris County Precinct and its constituents.

Grantee is required to submit original invoices to the HCDE Business Office ATTN: Accounts Payable. The invoices can be mailed through the postal service to HCDE Business Office ATTN: Accounts Payable 6300 Irvington Boulevard Houston, Texas 77022 or emailed to [accountspayable@hcde-texas.org](mailto:accountspayable@hcde-texas.org).

The invoice should include the following:

1. Date of invoice
2. Period of service (i.e. month of)
3. Invoice Number
4. Contact Information
5. Deliverables under the contract: CASE for Kids County Connections 2021
6. Certification of service provided through a signature by company representative.

Budget Period 2020-2021	
Project Administration	
Program Quality Improvement	
Payroll & Staff	\$12,000
Professional Service	
Supplies and Materials	\$500
Events	
Buses/Mileage	
Scholarship/Discounted Fees	\$7,500
Miscellaneous	
<b>Total Budget: \$20,000</b>	

**Grantee’s Requirements**

1. Grant recipients must meet the following requirements, according to the schedule and deadlines set by HCDE:

- a. Grantees shall maintain all records and accounts in a manner that shall assure full accounting of all expenditures paid for with both funds received from HCDE and local site matching funds relating to the signed Notice of Grant Award (NOGA). Grantee records and accounts shall be retained by the grantee and made available for audit by HCDE, Harris County, or their respective representatives for a period of not less than three (3) years after the expiration or termination of the NOGA. If an audit has been announced, the grantee shall retain its records and accounts until such audit has been completed.
  - b. Grantee shall comply with all applicable federal, state, and municipal laws, ordinances, rules, and regulations and certify such compliance upon request.
  - c. Complete a final report at the end of the program period, including but not limited to attendance forms and a project summary form provided by CASE for Kids detailing project accomplishments and challenges, photo documentation of the project, and promotional materials.
  - d. Submit attendance and demographics for youth served with program grant funding, in the manner required by HCDE.
  - e. Comply with evaluations required by HCDE, which may include site visits, focus groups, and surveys.
  - f. Agree to obtain and assess criminal history record information for each employee, contractor, or volunteer used in the delivery of projects funded by program grant funds and to use only those persons fit to work with students.
  - g. Submit an HCDE vendor packet to include, at a minimum, the following: W-9 Form, Conflict of Interest Form, Felony Conviction Affidavit Form, and Covered Employee Affidavit Form.
  - h. Staff members of the funded organization are eligible to attend the CASE for Kids free Afterschool Community Training Series.
  - i. Awarded organizations are required to attend two (2) mandatory meetings presented by CASE for Kids staff during the grant term on topics related to grant compliance, funding and resources on program implementation. The mandatory workshop schedule and details will be emailed to grantees.
  - j. Provides a safe and inclusive environment for youth. See details on [www.hcde-texas.org/afterschoolzone](http://www.hcde-texas.org/afterschoolzone).
2. Grantee agrees to meet CASE for Kids quality framework: element one- safe and inclusive environment and element four- collaborative relationships.

## **Program Promotion**

All promotional material or press releases for the project must include the following: County Connections is funded in part by Harris County, and administrated by Harris County Department of Education via CASE for Kids.

Promotional materials or press releases for the project must not include: Logos for Harris County, CASE for Kids, and Harris County Department of Education may not be used in program promotion.

## **Program Compliance & Documentation**

Grantee must adhere to all of the following requirements.

1. Final Report Form – Grantee must provide a final report form that will include a narrative that will highlight the work of the program, challenges, and overall outcome of the program. The final report must also demonstrate how the grantee enhanced program quality during the grant period, as well as provide supporting documentation. Final Report Forms must be submitted to the CASE office, 6005 Westview, Houston, TX 77055 no later than 15 days after the August 15, 2021. To conserve paper, final report and supporting documentation must be submitted items on a flash drive. Files must be in PC format.
2. Student Data Impact- Grantee must utilize the database provided by HCDE to complete attendance information, unless otherwise instructed by CASE for Kids. Grantee will also obtain demographic information through a student registration form that will be provided through the CASE for Kids County Connections Registration Form or approved grantee organization registration form.
3. Proof of expenditures – All expenditures for the awarded amount must be documented.
  - a. Copies of original receipts for expenditures, proof of payroll/professional services, and all other expenses. (Original receipts may be requested upon review of the final report.)
4. Images from project– Eight (8) digital images of the project. Images must be submitted on a USB flash drive in JPG format.
5. Promotional materials – Any materials utilized to promote the County Connections project that include or mention Harris County, CASE for Kids and Harris County Department of Education. Include examples of all promotional materials (press releases, flyers, brochures, etc.).

## **Evaluation**

Grantee may be asked to participate in a more in-depth evaluation of funding impact, which may include site visits, focus groups, and surveys. If selected for this evaluation, Grantee agrees to work with HCDE's Division of Research and Evaluation to ensure the completion of post-project assessments.

Grantee must have an evaluation participation release form signed by a parent/guardian for each student who completes a project survey.

### **Language Assistance**

Grantee must acknowledge, in a form acceptable to HCDE where required by HCDE in a non-discriminatory manner, that it can provide reasonable assistance to non-English speaking participants in its Activity.

### **Insurance**

Grantees must provide proof of insurance, in no less than the amounts detailed in Exhibit "B" attached hereto and made a part hereof.

### **Termination**

If services are not delivered as detailed in this NOGA, the RFP, and/or Grantee's application/proposal, if Grantee does not timely submit a complete final report, if final evaluation by CASE for Kids results in concern over implementation of the project, or if Grantee does not submit evaluation pre/post assessments, the final 20% of the grant award will not be allocated, and Grantee may be required to return part or all of the previously allocated grant funding. Additionally, if Grantee does not adequately document proof of expenses, Grantee may be required to return all or a portion of the grant amount.

### **Indemnity**

**TO THE MAXIMUM EXTENT AUTHORIZED UNDER THE CONSTITUTION AND LAWS OF THE STATE OF TEXAS, GRANTEE WILL HOLD HCDE, ITS OFFICERS, AGENTS, AND EMPLOYEES HARMLESS FROM ANY AND ALL CLAIMS, DEMANDS, DAMAGES, LIABILITIES, AND COSTS WHICH RESULT FROM ANY WILLFUL MISCONDUCT OR NEGLIGENT ACT OR OMISSION OF GRANTEE, ITS OFFICERS, AGENTS, OR EMPLOYEES, PERTAINING TO ITS ACTIVITIES AND OBLIGATIONS UNDER THIS NOGA OR RELATED TO THE COUNTY CONNECTIONS PROGRAM.**

### **Non-Appropriation of Funds**

The term of this NOGA is a commitment of HCDE current revenue only. Notwithstanding anything to the contrary in this NOGA, HCDE's obligation to pay grant funds as stated herein is expressly contingent upon HCDE receiving local, state, and/or federal funds ("funds") for after-school and out-of-school activities that are sufficient to satisfy all obligations to other grantees with which HCDE contracts to provide County Connections projects. In the event HCDE does not receive those funds or sufficient funds, HCDE may terminate this NOGA and will not be responsible for paying Grantee the amount specified herein or for any of the costs of the County Connections program(s) provided by Grantee.

**Governing Law & Venue**

This NOGA shall be governed by and construed in accordance with the laws of the State of Texas, without regard to its conflicts of laws principles. The mandatory and exclusive venue for the adjudication or resolution of any dispute arising out of this NOGA or the County Connections project shall be in Harris County, Texas, and the parties hereby submit to the exclusive jurisdiction of said courts.

**Assignment**

Neither this NOGA nor any duties or obligations outlined in this NOGA shall be assignable by Grantee without the prior written consent of HCDE.

**Relationship**

It is understood and agreed that Grantee is an independent contractor. Nothing in this NOGA shall be interpreted or construed as creating or establishing the relationship of employer and employee between HCDE and any employee or agent of Grantee. The NOGA does not create a joint venture or business partnership under Texas law.

Grantee is solely responsible for the supervision, daily direction and control, payment of salary (including withholding of income taxes and social security), insurance, worker's compensation, and disability benefits and like requirements and obligations of Grantee's employees, agents, volunteers, and representatives.

**Amendment; Entire Agreement**

This NOGA may be amended only by the mutual agreement of the parties, in writing, to be attached to and incorporated in this NOGA.

This Notice of Grant Award ("NOGA"), HCDE's CASE for Kids County Connections Request for Proposals ("RFP"), and Grantee's proposal/application submitted in response to HCDE's RFP, and the attached and incorporated addendum or exhibits, if any, contain the entire agreement of the parties relative to the purpose(s) of the agreement and supercede any other representations, agreements, arrangements, negotiations, or understanding, oral or written, between the parties to this NOGA. In the event of a conflict between this NOGA and the RFP or Grantee's proposal/application submitted in response to the RFP, this NOGA shall control. In the event of a conflict between the RFP and Grantee's proposal/application submitted in response to the RFP, the RFP shall control.

Neither this NOGA, nor any term or provision hereof, nor any inclusion by reference, shall be construed as being for the benefit of any party not in signatory hereto.

Multicultural Education and Counseling  
through the Arts

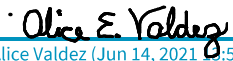
By:   
Alice Valdez (Jun 14, 2021 9:54 CDT)

(Signature)

Alice Valdez  
1900 Kane Street, Houston, TX 77007  
Phone: 713-802-9370  
Email: [alicevaldez4@gmail.com](mailto:alicevaldez4@gmail.com)

Harris County Department of Education

By: \_\_\_\_\_

(Signature)

Dr. Jesus Amezcua  
Assistant Superintendent, Business  
6300 Irvington Blvd.  
Houston, TX 77022-5618  
Phone: 713-696-8249 Fax: 713-696-0740  
Email: [jamezcua@hcde-texas.org](mailto:jamezcua@hcde-texas.org)

## Exhibit B

### GRANTEE INSURANCE REQUIREMENTS

Grantee is required to provide HCDE with copies of certificates of insurance, naming HCDE as an additional insured, for Texas Workman's Compensation and General Liability Insurance. Certificates of Insurance, name and address of Grantee, the limits of liability, the effective dates of each policy, and policy number shall be delivered to HCDE prior to commencement of any work under this Agreement. The insurance company insuring Grantee shall be licensed in the State of Texas and shall be acceptable to HCDE. Grantee shall give HCDE a minimum of ten (10) days' notice prior to any modifications or cancellation of said policies of insurance. Grantee shall require all subcontractors performing any work under or relating to this Agreement to maintain coverage as specified below.

Minimum Insurance Requirements:

- Grantee shall, at all times during the Term of this Agreement, maintain insurance coverage with not less than the type and requirements shown below. Such insurance is to be provided at the sole cost of Grantee. These requirements do not establish limits of Grantees's liability.
  - All policies of insurance shall waive all rights of subrogation against HCDE, its officers, employees, and agents.
  - Upon request, certified copies of original insurance policies shall be furnished to HCDE.
  - HCDE shall be named as an "additional insured" on all insurance policies.
  - HCDE reserves the right to require additional insurance should HCDE deem additional insurance necessary, in HCDE's sole discretion.
- A. Workers' Compensation (with Waiver of subrogation to HCDE) Employer's Liability, including all states, U.S. Longshoremen, Harbor Workers and other endorsements.
- B. Statutory, and Bodily Injury by Accident: \$100,000 each employee. Bodily Injury by Disease: \$500,000, policy limit \$100,000 each employee. Commercial General Liability Occurrence Form including, but not limited to, Premises and Operations, Products Liability Broad Form Property Damage, Contractual Liability, Personal and Advertising Injury Liability and where the exposure exists, coverage for watercraft, blasting collapse, and explosions, blowout, catering and underground damage.
- \$300,000 each occurrence Limit Bodily Injury and Property Damage combined
  - \$300,000 Products-Completed Operations Aggregate Limit \$500,000 per Job Aggregate
  - \$300,000 Personal and Advertising Injury Limit
- C. Automobile Liability Coverage  
\$300,000 Combined Liability Limits Bodily Injury and Property Damage Combined

In the event the above-detailed insurance requirements require modifications after the NOGA is executed, as determined by HCDE in its sole discretion, HCDE reserves the right to amend this Exhibit B to the NOGA, with such modifications to be effective upon written notice to Grantee, and Grantee agrees to comply with such modified requirements. Grantee acknowledges and agrees that continued payment by HCDE to Grantee under the NOGA is adequate consideration for agreeing to comply with the required insurance requirements, as modified. In the event such modified requirements are required, HCDE and Grantee agree that a formal amendment to the NOGA is not required, but the modified insurance requirements shall become effective upon written notice to Grantee.



**Regular Board Meeting**

**8.D.11.**

**Meeting Date:** July 21, 2021

**Title:** Service Agreement (Expenditure) with Boys and Girls Club of Greater Houston for CASE for Kids County Connections Youth Summer Initiative

**Submitted For:** Lisa Caruthers, Case for Kids      **Submitted By:** Kimberlee Flowers

**Recommended Action:** Approve      **HCDE Goal(s):** 1. Impact education/respond to evolving needs  
2. Deliver value responsibly  
3. Advocate for learners through innovation

**Additional Resource Personnel:** Danielle Bartz, Dr. Lisa Caruthers, Dr. Jesus Amezcua, Bill Monroe, Kendra Jackson      **Facilities/Technology Approval Needed?:**

**Information**

**Posted Agenda Item:**

**Ratification of award RFP#21/044KJ for County Connections-Youth Summer Initiative and Approve aggregate expenditures of \$80,000 from CASE for Kids to Boys and Girls Club of Greater Houston:** County Connections’ grant award (Expenditure Contracts) totaling \$30,000 for Boys and Girls Club of Greater Houston for Summer 2021 programming is in addition to prior awards of \$40,000 in Partnership Project funding and \$10,000 in City Connections funding for a total aggregate amount of \$80,000. County Connections will increase number of students served, number of sites served and/or timeframe in which students are served.

**Subject:**

Service Agreement (Expenditure) with Boys and Girls Club of Greater Houston for CASE for Kids County Connections-Youth Summer Initiative

**Rationale:**

County Connections Youth Summer Initiative 2021, funded directly by Harris County, supports nonprofit organizations that address the need for youth services during the summer. Initiatives funded by the CASE for Kids County Connections program can provide comprehensive summer programs, short term projects and summer camps hosted in-person or virtually from a variety of locations including schools, community centers, apartment complexes and churches. Initiatives are customized to meet community needs of individual Harris County Precincts. Services must include resources or reduce cost for summer initiatives for families during pandemic conditions.

Boys and Girls Club of Greater Houston (BGCGH) locations will receive \$5,000 in funding for Morefield Club and Allen Parkway Club to serve 75 students in Precinct 1, \$5,000 in funding for Havard Club and Texans Teen Club to serve a total of 70 students in Precinct 2, \$20,000 in funding for Spring Branch Club and Buffalo Creek Club to serve a total of 75 students in Precinct 4. This service agreement is in addition to a prior Partnership Project grant award for \$20,000 to serve 100 students at Havard Club and for \$20,000 to serve 100 students at Holthouse Club, and a prior grant award for \$10,000 for Fort Bend Club through City Connections, serving 116 students in City Council Districts K for the aggregate amount of \$80,000 in awards from CASE for Kids.

**Fiscal Impact**

**Attachments**

\*\*\*\*\*NOTICE OF GRANT AWARD\*\*\*\*\*

Project Title: CASE for Kids County Connections Youth Summer Initiative 2021  
Grant Term: June 14, 2021 – August 15, 2021  
Center for Afterschool, Summer, and Enrichment for Kids (CASE for Kids)  
Harris County Department of Education

\*\*\*\*\*

Boys & Girls Clubs of Greater Houston  
Kevin Hattery  
815 Crosby, Houston, Texas 77019

Dear Boys & Girls Clubs of Greater Houston,

The Harris County Department of Education (“HCDE”) hereby awards a grant in the amount of \$5,000 to Boys & Girls Clubs of Greater Houston (“Grantee”) in support of the above-referenced project. This award is subject to the terms and conditions specified herein (the “NOGA”) and in HCDE’s CASE for Kids County Connections Request for Proposals (“RFP”). Acceptance of this award, including the terms and conditions detailed in this NOGA, is acknowledged by the Grantee by returning (1) one signed original to HCDE CASE for Kids, no later than June 11, 2021.

In consideration of the mutual covenants and conditions contained in this Notice of Grant Award (“NOGA”) and other good and valuable consideration, the receipt and sufficiency of which are hereby acknowledged, the parties, intending to be legally bound, agree as follows:

**Program Description**

*To inspire and enable all youth to realize their full potential as productive, responsible and caring citizens. DIY STEM activities will introduce youth to hands-on learning experiences they might not otherwise have in science, technology, engineering and math. There will be an opportunity to participate in at least 60 minutes of physical activity daily.*

CASE for Kids County Connections Site(s): ***Morefield Club  
Allen Parkway Club***

**Term**

Grantee must start programming on or after June 14, 2021 and end programming no later than August 15, 2021. Your grant application proposed the dates and times described on the CASE for Kids County Connections Proposed Site List. Changes to program dates or times must be submitted in writing to HCDE’s CASE division and approved by CASE in advance.

**Compensation**

Upon return of (1) one signed original of the Notice of Grant Award, Grantee must submit an invoice for 80% of the grant award for payment. The final 20% of the grant award will be paid upon receipt and approval of an invoice, documentation of expenditures, and the final report as outlined below.

Grantee shall match the total amount of program grant funding on a dollar-for-dollar basis. The match may be cash or in-kind support from other sources. Grantee shall maintain sufficient documentation of its match and produce said documentation to HCDE upon request.

Grantee agrees to expend grant funding to support the proposed project, as described, to provide service for the Harris County Precinct and its constituents.

Grantee is required to submit original invoices to the HCDE Business Office ATTN: Accounts Payable. The invoices can be mailed through the postal service to HCDE Business Office ATTN: Accounts Payable 6300 Irvington Boulevard Houston, Texas 77022 or emailed to [accountspayable@hcde-texas.org](mailto:accountspayable@hcde-texas.org).

The invoice should include the following:

1. Date of invoice
2. Period of service (i.e. month of)
3. Invoice Number
4. Contact Information
5. Deliverables under the contract: CASE for Kids County Connections 2021
6. Certification of service provided through a signature by company representative.

Budget Period 2020-2021	
Project Administration	
Program Quality Improvement	
Payroll & Staff	\$5,000.00
Professional Service	
Supplies and Materials	
Events	
Buses/Mileage	
Scholarship/Discounted Fees	
Miscellaneous	
<b>Total Budget: \$5,000.00</b>	

**Grantee’s Requirements**

1. Grant recipients must meet the following requirements, according to the schedule and deadlines set by HCDE:
  - a. Grantees shall maintain all records and accounts in a manner that shall assure full accounting of all expenditures paid for with both funds received from HCDE and local site matching funds relating to the signed Notice of Grant Award (NOGA). Grantee records and accounts shall be retained by the grantee and made available for audit by HCDE, Harris County, or their respective representatives for a period of not less than three (3) years after the expiration or termination of the NOGA. If

an audit has been announced, the grantee shall retain its records and accounts until such audit has been completed.

- b. Grantee shall comply with all applicable federal, state, and municipal laws, ordinances, rules, and regulations and certify such compliance upon request.
  - c. Complete a final report at the end of the program period, including but not limited to attendance forms and a project summary form provided by CASE for Kids detailing project accomplishments and challenges, photo documentation of the project, and promotional materials.
  - d. Submit attendance and demographics for youth served with program grant funding, in the manner required by HCDE.
  - e. Comply with evaluations required by HCDE, which may include site visits, focus groups, and surveys.
  - f. Agree to obtain and assess criminal history record information for each employee, contractor, or volunteer used in the delivery of projects funded by program grant funds and to use only those persons fit to work with students.
  - g. Submit an HCDE vendor packet to include, at a minimum, the following: W-9 Form, Conflict of Interest Form, Felony Conviction Affidavit Form, and Covered Employee Affidavit Form.
  - h. Staff members of the funded organization are eligible to attend the CASE for Kids free Afterschool Community Training Series.
  - i. Awarded organizations are required to attend two (2) mandatory meetings presented by CASE for Kids staff during the grant term on topics related to grant compliance, funding and resources on program implementation. The mandatory workshop schedule and details will be emailed to grantees.
  - j. Provides a safe and inclusive environment for youth. See details on [www.hcde-texas.org/afterschoolzone](http://www.hcde-texas.org/afterschoolzone).
2. Grantee agrees to meet CASE for Kids quality framework: element one- safe and inclusive environment and element four- collaborative relationships.

### **Program Promotion**

All promotional material or press releases for the project must include the following: County Connections is funded in part by Harris County, and administrated by Harris County Department of Education via CASE for Kids.

Promotional materials or press releases for the project must not include:  
Logos for Harris County, CASE for Kids, and Harris County Department of Education may not be used in program promotion.

### **Program Compliance & Documentation**

Grantee must adhere to all of the following requirements.

1. Final Report Form – Grantee must provide a final report form that will include a narrative that will highlight the work of the program, challenges, and overall outcome of the program. The final report must also demonstrate how the grantee enhanced program quality during the grant period, as well as provide supporting documentation. Final Report Forms must be submitted to the CASE office, 6005 Westview, Houston, TX 77055 no later than 15 days after the August 15, 2021. To conserve paper, final report and supporting documentation must be submitted items on a flash drive. Files must be in PC format.
2. Student Data Impact- Grantee must utilize the database provided by HCDE to complete attendance information, unless otherwise instructed by CASE for Kids. Grantee will also obtain demographic information through a student registration form that will be provided through the CASE for Kids County Connections Registration Form or approved grantee organization registration form.
3. Proof of expenditures – All expenditures for the awarded amount must be documented.
  - a. Copies of original receipts for expenditures, proof of payroll/professional services, and all other expenses. (Original receipts may be requested upon review of the final report.)
4. Images from project– Eight (8) digital images of the project. Images must be submitted on a USB flash drive in JPG format.
5. Promotional materials – Any materials utilized to promote the County Connections project that include or mention Harris County, CASE for Kids and Harris County Department of Education. Include examples of all promotional materials (press releases, flyers, brochures, etc.).

### **Evaluation**

Grantee may be asked to participate in a more in-depth evaluation of funding impact, which may include site visits, focus groups, and surveys. If selected for this evaluation, Grantee agrees to work with HCDE's Division of Research and Evaluation to ensure the completion of post-project assessments.

Grantee must have an evaluation participation release form signed by a parent/guardian for each student who completes a project survey.

### **Language Assistance**

Grantee must acknowledge, in a form acceptable to HCDE where required by HCDE in a non-discriminatory manner, that it can provide reasonable assistance to non-English speaking participants in its Activity.

### **Insurance**

Grantees must provide proof of insurance, in no less than the amounts detailed in Exhibit "B" attached hereto and made a part hereof.

### **Termination**

If services are not delivered as detailed in this NOGA, the RFP, and/or Grantee's application/proposal, if Grantee does not timely submit a complete final report, if final evaluation by CASE for Kids results in concern over implementation of the project, or if Grantee does not submit evaluation pre/post assessments, the final 20% of the grant award will not be allocated, and Grantee may be required to return part or all of the previously allocated grant funding. Additionally, if Grantee does not adequately document proof of expenses, Grantee may be required to return all or a portion of the grant amount.

### **Indemnity**

**TO THE MAXIMUM EXTENT AUTHORIZED UNDER THE CONSTITUTION AND LAWS OF THE STATE OF TEXAS, GRANTEE WILL HOLD HCDE, ITS OFFICERS, AGENTS, AND EMPLOYEES HARMLESS FROM ANY AND ALL CLAIMS, DEMANDS, DAMAGES, LIABILITIES, AND COSTS WHICH RESULT FROM ANY WILLFUL MISCONDUCT OR NEGLIGENT ACT OR OMISSION OF GRANTEE, ITS OFFICERS, AGENTS, OR EMPLOYEES, PERTAINING TO ITS ACTIVITIES AND OBLIGATIONS UNDER THIS NOGA OR RELATED TO THE COUNTY CONNECTIONS PROGRAM.**

### **Non-Appropriation of Funds**

The term of this NOGA is a commitment of HCDE current revenue only. Notwithstanding anything to the contrary in this NOGA, HCDE's obligation to pay grant funds as stated herein is expressly contingent upon HCDE receiving local, state, and/or federal funds ("funds") for after-school and out-of-school activities that are sufficient to satisfy all obligations to other grantees with which HCDE contracts to provide County Connections projects. In the event HCDE does not receive those funds or sufficient funds, HCDE may terminate this NOGA and will not be responsible for paying Grantee the amount specified herein or for any of the costs of the County Connections program(s) provided by Grantee.

### **Governing Law & Venue**

This NOGA shall be governed by and construed in accordance with the laws of the State of Texas, without regard to its conflicts of laws principles. The mandatory and exclusive venue for the adjudication or resolution of any dispute arising out of this NOGA or the County Connections project shall be in Harris County, Texas, and the parties hereby submit to the exclusive jurisdiction of said courts.

**Assignment**

Neither this NOGA nor any duties or obligations outlined in this NOGA shall be assignable by Grantee without the prior written consent of HCDE.

**Relationship**

It is understood and agreed that Grantee is an independent contractor. Nothing in this NOGA shall be interpreted or construed as creating or establishing the relationship of employer and employee between HCDE and any employee or agent of Grantee. The NOGA does not create a joint venture or business partnership under Texas law.

Grantee is solely responsible for the supervision, daily direction and control, payment of salary (including withholding of income taxes and social security), insurance, worker's compensation, and disability benefits and like requirements and obligations of Grantee's employees, agents, volunteers, and representatives.

**Amendment; Entire Agreement**

This NOGA may be amended only by the mutual agreement of the parties, in writing, to be attached to and incorporated in this NOGA.

This Notice of Grant Award ("NOGA"), HCDE's CASE for Kids County Connections Request for Proposals ("RFP"), and Grantee's proposal/application submitted in response to HCDE's RFP, and the attached and incorporated addendum or exhibits, if any, contain the entire agreement of the parties relative to the purpose(s) of the agreement and supercede any other representations, agreements, arrangements, negotiations, or understanding, oral or written, between the parties to this NOGA. In the event of a conflict between this NOGA and the RFP or Grantee's proposal/application submitted in response to the RFP, this NOGA shall control. In the event of a conflict between the RFP and Grantee's proposal/application submitted in response to the RFP, the RFP shall control.

Neither this NOGA, nor any term or provision hereof, nor any inclusion by reference, shall be construed as being for the benefit of any party not in signatory hereto.

Boys & Girls Clubs of Greater Houston

By: *Kevin R Hattery.*  
Kevin R Hattery. (Jun 10, 2021 15:16 CDT)

(Signature)

Kevin Hattery  
815 Crosby, Houston, Texas 77019  
Phone: 713-400-2946  
Email: [khattery@bgcgh.org](mailto:khattery@bgcgh.org)

Harris County Department of Education

By: \_\_\_\_\_

(Signature)

Dr. Jesus Amezcua  
Assistant Superintendent, Business  
6300 Irvington Blvd.  
Houston, TX 77022-5618  
Phone: 713-696-8249 Fax: 713-696-0740  
Email: [jamezcua@hcde-texas.org](mailto:jamezcua@hcde-texas.org)



## Exhibit B

### GRANTEE INSURANCE REQUIREMENTS

Grantee is required to provide HCDE with copies of certificates of insurance, naming HCDE as an additional insured, for Texas Workman's Compensation and General Liability Insurance. Certificates of Insurance, name and address of Grantee, the limits of liability, the effective dates of each policy, and policy number shall be delivered to HCDE prior to commencement of any work under this Agreement. The insurance company insuring Grantee shall be licensed in the State of Texas and shall be acceptable to HCDE. Grantee shall give HCDE a minimum of ten (10) days' notice prior to any modifications or cancellation of said policies of insurance. Grantee shall require all subcontractors performing any work under or relating to this Agreement to maintain coverage as specified below.

Minimum Insurance Requirements:

- Grantee shall, at all times during the Term of this Agreement, maintain insurance coverage with not less than the type and requirements shown below. Such insurance is to be provided at the sole cost of Grantee. These requirements do not establish limits of Grantees's liability.
  - All policies of insurance shall waive all rights of subrogation against HCDE, its officers, employees, and agents.
  - Upon request, certified copies of original insurance policies shall be furnished to HCDE.
  - HCDE shall be named as an "additional insured" on all insurance policies.
  - HCDE reserves the right to require additional insurance should HCDE deem additional insurance necessary, in HCDE's sole discretion.
- A. Workers' Compensation (with Waiver of subrogation to HCDE) Employer's Liability, including all states, U.S. Longshoremen, Harbor Workers and other endorsements.
- B. Statutory, and Bodily Injury by Accident: \$100,000 each employee. Bodily Injury by Disease: \$500,000, policy limit \$100,000 each employee. Commercial General Liability Occurrence Form including, but not limited to, Premises and Operations, Products Liability Broad Form Property Damage, Contractual Liability, Personal and Advertising Injury Liability and where the exposure exists, coverage for watercraft, blasting collapse, and explosions, blowout, catering and underground damage.
- \$300,000 each occurrence Limit Bodily Injury and Property Damage combined
  - \$300,000 Products-Completed Operations Aggregate Limit \$500,000 per Job Aggregate
  - \$300,000 Personal and Advertising Injury Limit
- C. Automobile Liability Coverage  
\$300,000 Combined Liability Limits Bodily Injury and Property Damage Combined

In the event the above-detailed insurance requirements require modifications after the NOGA is executed, as determined by HCDE in its sole discretion, HCDE reserves the right to amend this Exhibit B to the NOGA, with such modifications to be effective upon written notice to Grantee, and Grantee agrees to comply with such modified requirements. Grantee acknowledges and agrees that continued payment by HCDE to Grantee under the NOGA is adequate consideration for agreeing to comply with the required insurance requirements, as modified. In the event such modified requirements are required, HCDE and Grantee agree that a formal amendment to the NOGA is not required, but the modified insurance requirements shall become effective upon written notice to Grantee.

\*\*\*\*\*NOTICE OF GRANT AWARD\*\*\*\*\*

Project Title: CASE for Kids County Connections Youth Summer Initiative 2021  
Grant Term: June 14, 2021 – August 15, 2021  
Center for Afterschool, Summer, and Enrichment for Kids (CASE for Kids)  
Harris County Department of Education

\*\*\*\*\*

Boys & Girls Clubs of Greater Houston  
Kevin Hattery  
815 Crosby, Houston, TX 77019

Dear Boys & Girls Clubs of Greater Houston,

The Harris County Department of Education (“HCDE”) hereby awards a grant in the amount of \$5,000 to Boys & Girls Clubs of Greater Houston (“Grantee”) in support of the above-referenced project. This award is subject to the terms and conditions specified herein (the “NOGA”) and in HCDE’s CASE for Kids County Connections Request for Proposals (“RFP”). Acceptance of this award, including the terms and conditions detailed in this NOGA, is acknowledged by the Grantee by returning (1) one signed original to HCDE CASE for Kids, no later than June 11, 2021.

In consideration of the mutual covenants and conditions contained in this Notice of Grant Award (“NOGA”) and other good and valuable consideration, the receipt and sufficiency of which are hereby acknowledged, the parties, intending to be legally bound, agree as follows:

**Program Description**

*The curriculum for the Summer Learning Program is called Summer Brain Gain and consists of one-week modules with engaging, themed activities that are aligned with core standards. Using a project-based learning approach, each module includes a process of discovery, creative expression, group activities and a final project or production. A literacy component presents a new book each week for each age group, along with supporting activities that bring the books to life. DIY STEM activities introduce youth to hands-on learning experiences they might not otherwise have in science, technology, engineering and math. Summer Learning Program participants also receive 2 healthy meals each day, a healthy snack and opportunities to participate in at least 60 minutes of physical activity daily.*

CASE for Kids County Connections Site(s): **HAVARD CLUB**  
**TEXANS TEEN CLUB**

**Term**

Grantee must start programming on or after June 14, 2021 and end programming no later than August 15, 2021. Your grant application proposed the dates and times described on the CASE

for Kids County Connections Proposed Site List. Changes to program dates or times must be submitted in writing to HCDE’s CASE division and approved by CASE in advance.

**Compensation**

Upon return of (1) one signed original of the Notice of Grant Award, Grantee must submit an invoice for 80% of the grant award for payment. The final 20% of the grant award will be paid upon receipt and approval of an invoice, documentation of expenditures, and the final report as outlined below.

Grantee shall match the total amount of program grant funding on a dollar-for-dollar basis. The match may be cash or in-kind support from other sources. Grantee shall maintain sufficient documentation of its match and produce said documentation to HCDE upon request.

Grantee agrees to expend grant funding to support the proposed project, as described, to provide service for the Harris County Precinct and its constituents.

Grantee is required to submit original invoices to the HCDE Business Office ATTN: Accounts Payable. The invoices can be mailed through the postal service to HCDE Business Office ATTN: Accounts Payable 6300 Irvington Boulevard Houston, Texas 77022 or emailed to [accountspayable@hcde-texas.org](mailto:accountspayable@hcde-texas.org).

The invoice should include the following:

1. Date of invoice
2. Period of service (i.e. month of)
3. Invoice Number
4. Contact Information
5. Deliverables under the contract: CASE for Kids County Connections 2021
6. Certification of service provided through a signature by company representative.

Budget Period 2020-2021	
Project Administration	\$
Program Quality Improvement	\$
Payroll & Staff	\$5,000
Professional Service	\$
Supplies and Materials	\$
Events	\$
Buses/Mileage	\$
Scholarship/Discounted Fees	
Miscellaneous	\$
<b>Total Budget: \$5,000</b>	

**Grantee’s Requirements**

1. Grant recipients must meet the following requirements, according to the schedule and deadlines set by HCDE:

- a. Grantees shall maintain all records and accounts in a manner that shall assure full accounting of all expenditures paid for with both funds received from HCDE and local site matching funds relating to the signed Notice of Grant Award (NOGA). Grantee records and accounts shall be retained by the grantee and made available for audit by HCDE, Harris County, or their respective representatives for a period of not less than three (3) years after the expiration or termination of the NOGA. If an audit has been announced, the grantee shall retain its records and accounts until such audit has been completed.
  - b. Grantee shall comply with all applicable federal, state, and municipal laws, ordinances, rules, and regulations and certify such compliance upon request.
  - c. Complete a final report at the end of the program period, including but not limited to attendance forms and a project summary form provided by CASE for Kids detailing project accomplishments and challenges, photo documentation of the project, and promotional materials.
  - d. Submit attendance and demographics for youth served with program grant funding, in the manner required by HCDE.
  - e. Comply with evaluations required by HCDE, which may include site visits, focus groups, and surveys.
  - f. Agree to obtain and assess criminal history record information for each employee, contractor, or volunteer used in the delivery of projects funded by program grant funds and to use only those persons fit to work with students.
  - g. Submit an HCDE vendor packet to include, at a minimum, the following: W-9 Form, Conflict of Interest Form, Felony Conviction Affidavit Form, and Covered Employee Affidavit Form.
  - h. Staff members of the funded organization are eligible to attend the CASE for Kids free Afterschool Community Training Series.
  - i. Awarded organizations are required to attend two (2) mandatory meetings presented by CASE for Kids staff during the grant term on topics related to grant compliance, funding and resources on program implementation. The mandatory workshop schedule and details will be emailed to grantees.
  - j. Provides a safe and inclusive environment for youth. See details on [www.hcde-texas.org/afterschoolzone](http://www.hcde-texas.org/afterschoolzone).
2. Grantee agrees to meet CASE for Kids quality framework: element one- safe and inclusive environment and element four- collaborative relationships.

## **Program Promotion**

All promotional material or press releases for the project must include the following: County Connections is funded in part by Harris County, and administrated by Harris County Department of Education via CASE for Kids.

Promotional materials or press releases for the project must not include: Logos for Harris County, CASE for Kids, and Harris County Department of Education may not be used in program promotion.

## **Program Compliance & Documentation**

Grantee must adhere to all of the following requirements.

1. Final Report Form – Grantee must provide a final report form that will include a narrative that will highlight the work of the program, challenges, and overall outcome of the program. The final report must also demonstrate how the grantee enhanced program quality during the grant period, as well as provide supporting documentation. Final Report Forms must be submitted to the CASE office, 6005 Westview, Houston, TX 77055 no later than 15 days after the August 15, 2021. To conserve paper, final report and supporting documentation must be submitted items on a flash drive. Files must be in PC format.
2. Student Data Impact- Grantee must utilize the database provided by HCDE to complete attendance information, unless otherwise instructed by CASE for Kids. Grantee will also obtain demographic information through a student registration form that will be provided through the CASE for Kids County Connections Registration Form or approved grantee organization registration form.
3. Proof of expenditures – All expenditures for the awarded amount must be documented.
  - a. Copies of original receipts for expenditures, proof of payroll/professional services, and all other expenses. (Original receipts may be requested upon review of the final report.)
4. Images from project– Eight (8) digital images of the project. Images must be submitted on a USB flash drive in JPG format.
5. Promotional materials – Any materials utilized to promote the County Connections project that include or mention Harris County, CASE for Kids and Harris County Department of Education. Include examples of all promotional materials (press releases, flyers, brochures, etc.).

## **Evaluation**

Grantee may be asked to participate in a more in-depth evaluation of funding impact, which may include site visits, focus groups, and surveys. If selected for this evaluation, Grantee agrees to work with HCDE's Division of Research and Evaluation to ensure the completion of post-project assessments.

Grantee must have an evaluation participation release form signed by a parent/guardian for each student who completes a project survey.

### **Language Assistance**

Grantee must acknowledge, in a form acceptable to HCDE where required by HCDE in a non-discriminatory manner, that it can provide reasonable assistance to non-English speaking participants in its Activity.

### **Insurance**

Grantees must provide proof of insurance, in no less than the amounts detailed in Exhibit "B" attached hereto and made a part hereof.

### **Termination**

If services are not delivered as detailed in this NOGA, the RFP, and/or Grantee's application/proposal, if Grantee does not timely submit a complete final report, if final evaluation by CASE for Kids results in concern over implementation of the project, or if Grantee does not submit evaluation pre/post assessments, the final 20% of the grant award will not be allocated, and Grantee may be required to return part or all of the previously allocated grant funding. Additionally, if Grantee does not adequately document proof of expenses, Grantee may be required to return all or a portion of the grant amount.

### **Indemnity**

**TO THE MAXIMUM EXTENT AUTHORIZED UNDER THE CONSTITUTION AND LAWS OF THE STATE OF TEXAS, GRANTEE WILL HOLD HCDE, ITS OFFICERS, AGENTS, AND EMPLOYEES HARMLESS FROM ANY AND ALL CLAIMS, DEMANDS, DAMAGES, LIABILITIES, AND COSTS WHICH RESULT FROM ANY WILLFUL MISCONDUCT OR NEGLIGENT ACT OR OMISSION OF GRANTEE, ITS OFFICERS, AGENTS, OR EMPLOYEES, PERTAINING TO ITS ACTIVITIES AND OBLIGATIONS UNDER THIS NOGA OR RELATED TO THE COUNTY CONNECTIONS PROGRAM.**

### **Non-Appropriation of Funds**

The term of this NOGA is a commitment of HCDE current revenue only. Notwithstanding anything to the contrary in this NOGA, HCDE's obligation to pay grant funds as stated herein is expressly contingent upon HCDE receiving local, state, and/or federal funds ("funds") for after-school and out-of-school activities that are sufficient to satisfy all obligations to other grantees with which HCDE contracts to provide County Connections projects. In the event HCDE does not receive those funds or sufficient funds, HCDE may terminate this NOGA and will not be responsible for paying Grantee the amount specified herein or for any of the costs of the County Connections program(s) provided by Grantee.

**Governing Law & Venue**

This NOGA shall be governed by and construed in accordance with the laws of the State of Texas, without regard to its conflicts of laws principles. The mandatory and exclusive venue for the adjudication or resolution of any dispute arising out of this NOGA or the County Connections project shall be in Harris County, Texas, and the parties hereby submit to the exclusive jurisdiction of said courts.

**Assignment**

Neither this NOGA nor any duties or obligations outlined in this NOGA shall be assignable by Grantee without the prior written consent of HCDE.

**Relationship**

It is understood and agreed that Grantee is an independent contractor. Nothing in this NOGA shall be interpreted or construed as creating or establishing the relationship of employer and employee between HCDE and any employee or agent of Grantee. The NOGA does not create a joint venture or business partnership under Texas law.

Grantee is solely responsible for the supervision, daily direction and control, payment of salary (including withholding of income taxes and social security), insurance, worker's compensation, and disability benefits and like requirements and obligations of Grantee's employees, agents, volunteers, and representatives.

**Amendment; Entire Agreement**

This NOGA may be amended only by the mutual agreement of the parties, in writing, to be attached to and incorporated in this NOGA.

This Notice of Grant Award ("NOGA"), HCDE's CASE for Kids County Connections Request for Proposals ("RFP"), and Grantee's proposal/application submitted in response to HCDE's RFP, and the attached and incorporated addendum or exhibits, if any, contain the entire agreement of the parties relative to the purpose(s) of the agreement and supercede any other representations, agreements, arrangements, negotiations, or understanding, oral or written, between the parties to this NOGA. In the event of a conflict between this NOGA and the RFP or Grantee's proposal/application submitted in response to the RFP, this NOGA shall control. In the event of a conflict between the RFP and Grantee's proposal/application submitted in response to the RFP, the RFP shall control.

Neither this NOGA, nor any term or provision hereof, nor any inclusion by reference, shall be construed as being for the benefit of any party not in signatory hereto.

Boys & Girls Clubs of Greater Houston

By: *Kevin R Hattery.*  
Kevin R Hattery. (Jun 10, 2021 15:15 CDT)

(Signature)

Kevin Hattery  
815 Crosby, Houston, TX 77019  
Phone: 713-400-2946  
Email: [khattery@bgcgh.org](mailto:khattery@bgcgh.org)

Harris County Department of Education

By: \_\_\_\_\_

(Signature)

Dr. Jesus Amezcua  
Assistant Superintendent, Business  
6300 Irvington Blvd.  
Houston, TX 77022-5618  
Phone: 713-696-8249 Fax: 713-696-0740  
Email: [jamezcua@hcde-texas.org](mailto:jamezcua@hcde-texas.org)



## Exhibit B

### GRANTEE INSURANCE REQUIREMENTS

Grantee is required to provide HCDE with copies of certificates of insurance, naming HCDE as an additional insured, for Texas Workman's Compensation and General Liability Insurance. Certificates of Insurance, name and address of Grantee, the limits of liability, the effective dates of each policy, and policy number shall be delivered to HCDE prior to commencement of any work under this Agreement. The insurance company insuring Grantee shall be licensed in the State of Texas and shall be acceptable to HCDE. Grantee shall give HCDE a minimum of ten (10) days' notice prior to any modifications or cancellation of said policies of insurance. Grantee shall require all subcontractors performing any work under or relating to this Agreement to maintain coverage as specified below.

Minimum Insurance Requirements:

- Grantee shall, at all times during the Term of this Agreement, maintain insurance coverage with not less than the type and requirements shown below. Such insurance is to be provided at the sole cost of Grantee. These requirements do not establish limits of Grantees's liability.
  - All policies of insurance shall waive all rights of subrogation against HCDE, its officers, employees, and agents.
  - Upon request, certified copies of original insurance policies shall be furnished to HCDE.
  - HCDE shall be named as an "additional insured" on all insurance policies.
  - HCDE reserves the right to require additional insurance should HCDE deem additional insurance necessary, in HCDE's sole discretion.
- A. Workers' Compensation (with Waiver of subrogation to HCDE) Employer's Liability, including all states, U.S. Longshoremen, Harbor Workers and other endorsements.
- B. Statutory, and Bodily Injury by Accident: \$100,000 each employee. Bodily Injury by Disease: \$500,000, policy limit \$100,000 each employee. Commercial General Liability Occurrence Form including, but not limited to, Premises and Operations, Products Liability Broad Form Property Damage, Contractual Liability, Personal and Advertising Injury Liability and where the exposure exists, coverage for watercraft, blasting collapse, and explosions, blowout, catering and underground damage.
- \$300,000 each occurrence Limit Bodily Injury and Property Damage combined
  - \$300,000 Products-Completed Operations Aggregate Limit \$500,000 per Job Aggregate
  - \$300,000 Personal and Advertising Injury Limit
- C. Automobile Liability Coverage  
\$300,000 Combined Liability Limits Bodily Injury and Property Damage Combined

In the event the above-detailed insurance requirements require modifications after the NOGA is executed, as determined by HCDE in its sole discretion, HCDE reserves the right to amend this Exhibit B to the NOGA, with such modifications to be effective upon written notice to Grantee, and Grantee agrees to comply with such modified requirements. Grantee acknowledges and agrees that continued payment by HCDE to Grantee under the NOGA is adequate consideration for agreeing to comply with the required insurance requirements, as modified. In the event such modified requirements are required, HCDE and Grantee agree that a formal amendment to the NOGA is not required, but the modified insurance requirements shall become effective upon written notice to Grantee.

\*\*\*\*\***NOTICE OF GRANT AWARD**\*\*\*\*\*

Project Title: CASE for Kids County Connections Youth Summer Initiative 2021  
Grant Term: June 14, 2021 – August 15, 2021  
Center for Afterschool, Summer, and Enrichment for Kids (CASE for Kids)  
Harris County Department of Education

\*\*\*\*\*

Boys and Girls Club of Greater Houston  
Kevin Hattery  
815 Crosby, Houston, TX 77019

Dear Boys and Girls Club of Greater Houston,

The Harris County Department of Education (“HCDE”) hereby awards a grant in the amount of \$20,000 to Boys and Girls Club of Greater Houston (“Grantee”) in support of the above-referenced project. This award is subject to the terms and conditions specified herein (the “NOGA”) and in HCDE’s CASE for Kids County Connections Request for Proposals (“RFP”). Acceptance of this award, including the terms and conditions detailed in this NOGA, is acknowledged by the Grantee by returning (1) one signed original to HCDE CASE for Kids, no later than June 11, 2021.

In consideration of the mutual covenants and conditions contained in this Notice of Grant Award (“NOGA”) and other good and valuable consideration, the receipt and sufficiency of which are hereby acknowledged, the parties, intending to be legally bound, agree as follows:

**Program Description**

*To inspire and enable all youth to realize their full potential as productive, responsible and caring citizens. DIY STEM activities will introduce youth to hands-on learning experiences they might not otherwise have in science, technology, engineering and math. There will be an opportunity to participate in at least 60 minutes of physical activity daily.*

CASE for Kids County Connections Site(s): ***Spring Branch Club***  
***Buffalo Creek Club***

**Term**

Grantee must start programming on or after June 14, 2021 and end programming no later than August 15, 2021. Your grant application proposed the dates and times described on the CASE for Kids County Connections Proposed Site List. Changes to program dates or times must be submitted in writing to HCDE’s CASE division and approved by CASE in advance.

**Compensation**

Upon return of (1) one signed original of the Notice of Grant Award, Grantee must submit an invoice for 80% of the grant award for payment. The final 20% of the grant award will be paid upon receipt and approval of an invoice, documentation of expenditures, and the final report as outlined below.

Grantee shall match the total amount of program grant funding on a dollar-for-dollar basis. The match may be cash or in-kind support from other sources. Grantee shall maintain sufficient documentation of its match and produce said documentation to HCDE upon request.

Grantee agrees to expend grant funding to support the proposed project, as described, to provide service for the Harris County Precinct and its constituents.

Grantee is required to submit original invoices to the HCDE Business Office ATTN: Accounts Payable. The invoices can be mailed through the postal service to HCDE Business Office ATTN: Accounts Payable 6300 Irvington Boulevard Houston, Texas 77022 or emailed to [accountspayable@hcde-texas.org](mailto:accountspayable@hcde-texas.org).

The invoice should include the following:

1. Date of invoice
2. Period of service (i.e. month of)
3. Invoice Number
4. Contact Information
5. Deliverables under the contract: CASE for Kids County Connections 2021
6. Certification of service provided through a signature by company representative.

Budget Period 2020-2021	
Project Administration	\$
Program Quality Improvement	\$
Payroll & Staff	\$20,000
Professional Service	\$
Supplies and Materials	\$
Events	\$
Buses/Mileage	\$
Scholarship/Discounted Fees	
Miscellaneous	\$
<b>Total Budget: \$20,000</b>	

### Grantee's Requirements

1. Grant recipients must meet the following requirements, according to the schedule and deadlines set by HCDE:
  - a. Grantees shall maintain all records and accounts in a manner that shall assure full accounting of all expenditures paid for with both funds received from HCDE and local site matching funds relating to the signed Notice of Grant Award (NOGA). Grantee records and accounts shall be retained by the grantee and made available for audit by HCDE, Harris County, or their respective representatives for a period of not less than three (3) years after the expiration or termination of the NOGA. If

an audit has been announced, the grantee shall retain its records and accounts until such audit has been completed.

- b. Grantee shall comply with all applicable federal, state, and municipal laws, ordinances, rules, and regulations and certify such compliance upon request.
  - c. Complete a final report at the end of the program period, including but not limited to attendance forms and a project summary form provided by CASE for Kids detailing project accomplishments and challenges, photo documentation of the project, and promotional materials.
  - d. Submit attendance and demographics for youth served with program grant funding, in the manner required by HCDE.
  - e. Comply with evaluations required by HCDE, which may include site visits, focus groups, and surveys.
  - f. Agree to obtain and assess criminal history record information for each employee, contractor, or volunteer used in the delivery of projects funded by program grant funds and to use only those persons fit to work with students.
  - g. Submit an HCDE vendor packet to include, at a minimum, the following: W-9 Form, Conflict of Interest Form, Felony Conviction Affidavit Form, and Covered Employee Affidavit Form.
  - h. Staff members of the funded organization are eligible to attend the CASE for Kids free Afterschool Community Training Series.
  - i. Awarded organizations are required to attend two (2) mandatory meetings presented by CASE for Kids staff during the grant term on topics related to grant compliance, funding and resources on program implementation. The mandatory workshop schedule and details will be emailed to grantees.
  - j. Provides a safe and inclusive environment for youth. See details on [www.hcde-texas.org/afterschoolzone](http://www.hcde-texas.org/afterschoolzone).
2. Grantee agrees to meet CASE for Kids quality framework: element one- safe and inclusive environment and element four- collaborative relationships.

### **Program Promotion**

All promotional material or press releases for the project must include the following: County Connections is funded in part by Harris County, and administrated by Harris County Department of Education via CASE for Kids.

Promotional materials or press releases for the project must not include:  
Logos for Harris County, CASE for Kids, and Harris County Department of Education may not be used in program promotion.

### **Program Compliance & Documentation**

Grantee must adhere to all of the following requirements.

1. Final Report Form – Grantee must provide a final report form that will include a narrative that will highlight the work of the program, challenges, and overall outcome of the program. The final report must also demonstrate how the grantee enhanced program quality during the grant period, as well as provide supporting documentation. Final Report Forms must be submitted to the CASE office, 6005 Westview, Houston, TX 77055 no later than 15 days after the August 15, 2021. To conserve paper, final report and supporting documentation must be submitted items on a flash drive. Files must be in PC format.
2. Student Data Impact- Grantee must utilize the database provided by HCDE to complete attendance information, unless otherwise instructed by CASE for Kids. Grantee will also obtain demographic information through a student registration form that will be provided through the CASE for Kids County Connections Registration Form or approved grantee organization registration form.
3. Proof of expenditures – All expenditures for the awarded amount must be documented.
  - a. Copies of original receipts for expenditures, proof of payroll/professional services, and all other expenses. (Original receipts may be requested upon review of the final report.)
4. Images from project– Eight (8) digital images of the project. Images must be submitted on a USB flash drive in JPG format.
5. Promotional materials – Any materials utilized to promote the County Connections project that include or mention Harris County, CASE for Kids and Harris County Department of Education. Include examples of all promotional materials (press releases, flyers, brochures, etc.).

### **Evaluation**

Grantee may be asked to participate in a more in-depth evaluation of funding impact, which may include site visits, focus groups, and surveys. If selected for this evaluation, Grantee agrees to work with HCDE's Division of Research and Evaluation to ensure the completion of post-project assessments.

Grantee must have an evaluation participation release form signed by a parent/guardian for each student who completes a project survey.

**Language Assistance**

Grantee must acknowledge, in a form acceptable to HCDE where required by HCDE in a non-discriminatory manner, that it can provide reasonable assistance to non-English speaking participants in its Activity.

**Insurance**

Grantees must provide proof of insurance, in no less than the amounts detailed in Exhibit "B" attached hereto and made a part hereof.

**Termination**

If services are not delivered as detailed in this NOGA, the RFP, and/or Grantee's application/proposal, if Grantee does not timely submit a complete final report, if final evaluation by CASE for Kids results in concern over implementation of the project, or if Grantee does not submit evaluation pre/post assessments, the final 20% of the grant award will not be allocated, and Grantee may be required to return part or all of the previously allocated grant funding. Additionally, if Grantee does not adequately document proof of expenses, Grantee may be required to return all or a portion of the grant amount.

**Indemnity**

**TO THE MAXIMUM EXTENT AUTHORIZED UNDER THE CONSTITUTION AND LAWS OF THE STATE OF TEXAS, GRANTEE WILL HOLD HCDE, ITS OFFICERS, AGENTS, AND EMPLOYEES HARMLESS FROM ANY AND ALL CLAIMS, DEMANDS, DAMAGES, LIABILITIES, AND COSTS WHICH RESULT FROM ANY WILLFUL MISCONDUCT OR NEGLIGENT ACT OR OMISSION OF GRANTEE, ITS OFFICERS, AGENTS, OR EMPLOYEES, PERTAINING TO ITS ACTIVITIES AND OBLIGATIONS UNDER THIS NOGA OR RELATED TO THE COUNTY CONNECTIONS PROGRAM.**

**Non-Appropriation of Funds**

The term of this NOGA is a commitment of HCDE current revenue only. Notwithstanding anything to the contrary in this NOGA, HCDE's obligation to pay grant funds as stated herein is expressly contingent upon HCDE receiving local, state, and/or federal funds ("funds") for after-school and out-of-school activities that are sufficient to satisfy all obligations to other grantees with which HCDE contracts to provide County Connections projects. In the event HCDE does not receive those funds or sufficient funds, HCDE may terminate this NOGA and will not be responsible for paying Grantee the amount specified herein or for any of the costs of the County Connections program(s) provided by Grantee.

**Governing Law & Venue**

This NOGA shall be governed by and construed in accordance with the laws of the State of Texas, without regard to its conflicts of laws principles. The mandatory and exclusive venue for the adjudication or resolution of any dispute arising out of this NOGA or the County Connections project shall be in Harris County, Texas, and the parties hereby submit to the exclusive jurisdiction of said courts.

**Assignment**

Neither this NOGA nor any duties or obligations outlined in this NOGA shall be assignable by Grantee without the prior written consent of HCDE.

**Relationship**

It is understood and agreed that Grantee is an independent contractor. Nothing in this NOGA shall be interpreted or construed as creating or establishing the relationship of employer and employee between HCDE and any employee or agent of Grantee. The NOGA does not create a joint venture or business partnership under Texas law.

Grantee is solely responsible for the supervision, daily direction and control, payment of salary (including withholding of income taxes and social security), insurance, worker's compensation, and disability benefits and like requirements and obligations of Grantee's employees, agents, volunteers, and representatives.

**Amendment; Entire Agreement**

This NOGA may be amended only by the mutual agreement of the parties, in writing, to be attached to and incorporated in this NOGA.

This Notice of Grant Award ("NOGA"), HCDE's CASE for Kids County Connections Request for Proposals ("RFP"), and Grantee's proposal/application submitted in response to HCDE's RFP, and the attached and incorporated addendum or exhibits, if any, contain the entire agreement of the parties relative to the purpose(s) of the agreement and supercede any other representations, agreements, arrangements, negotiations, or understanding, oral or written, between the parties to this NOGA. In the event of a conflict between this NOGA and the RFP or Grantee's proposal/application submitted in response to the RFP, this NOGA shall control. In the event of a conflict between the RFP and Grantee's proposal/application submitted in response to the RFP, the RFP shall control.

Neither this NOGA, nor any term or provision hereof, nor any inclusion by reference, shall be construed as being for the benefit of any party not in signatory hereto.

Boys and Girls Club of Greater Houston

By: *Kevin R Hattery.*  
By: [Kevin R Hattery. \(Jun 10, 2021 15:15 CDT\)](#)

(Signature)

Kevin Hattery  
815 Crosby, Houston, TX 77019  
Phone: 713400-2946  
Email: [khattery@bgcgh.org](mailto:khattery@bgcgh.org)

Harris County Department of Education

By: \_\_\_\_\_

(Signature)

Dr. Jesus Amezcua  
Assistant Superintendent, Business  
6300 Irvington Blvd.  
Houston, TX 77022-5618  
Phone: 713-696-8249 Fax: 713-696-0740  
Email: [jamezcua@hcde-texas.org](mailto:jamezcua@hcde-texas.org)



## Exhibit B

### GRANTEE INSURANCE REQUIREMENTS

Grantee is required to provide HCDE with copies of certificates of insurance, naming HCDE as an additional insured, for Texas Workman's Compensation and General Liability Insurance. Certificates of Insurance, name and address of Grantee, the limits of liability, the effective dates of each policy, and policy number shall be delivered to HCDE prior to commencement of any work under this Agreement. The insurance company insuring Grantee shall be licensed in the State of Texas and shall be acceptable to HCDE. Grantee shall give HCDE a minimum of ten (10) days' notice prior to any modifications or cancellation of said policies of insurance. Grantee shall require all subcontractors performing any work under or relating to this Agreement to maintain coverage as specified below.

Minimum Insurance Requirements:

- Grantee shall, at all times during the Term of this Agreement, maintain insurance coverage with not less than the type and requirements shown below. Such insurance is to be provided at the sole cost of Grantee. These requirements do not establish limits of Grantees's liability.
  - All policies of insurance shall waive all rights of subrogation against HCDE, its officers, employees, and agents.
  - Upon request, certified copies of original insurance policies shall be furnished to HCDE.
  - HCDE shall be named as an "additional insured" on all insurance policies.
  - HCDE reserves the right to require additional insurance should HCDE deem additional insurance necessary, in HCDE's sole discretion.
- A. Workers' Compensation (with Waiver of subrogation to HCDE) Employer's Liability, including all states, U.S. Longshoremen, Harbor Workers and other endorsements.
- B. Statutory, and Bodily Injury by Accident: \$100,000 each employee. Bodily Injury by Disease: \$500,000, policy limit \$100,000 each employee. Commercial General Liability Occurrence Form including, but not limited to, Premises and Operations, Products Liability Broad Form Property Damage, Contractual Liability, Personal and Advertising Injury Liability and where the exposure exists, coverage for watercraft, blasting collapse, and explosions, blowout, catering and underground damage.
- \$300,000 each occurrence Limit Bodily Injury and Property Damage combined
  - \$300,000 Products-Completed Operations Aggregate Limit \$500,000 per Job Aggregate
  - \$300,000 Personal and Advertising Injury Limit
- C. Automobile Liability Coverage  
\$300,000 Combined Liability Limits Bodily Injury and Property Damage Combined

In the event the above-detailed insurance requirements require modifications after the NOGA is executed, as determined by HCDE in its sole discretion, HCDE reserves the right to amend this Exhibit B to the NOGA, with such modifications to be effective upon written notice to Grantee, and Grantee agrees to comply with such modified requirements. Grantee acknowledges and agrees that continued payment by HCDE to Grantee under the NOGA is adequate consideration for agreeing to comply with the required insurance requirements, as modified. In the event such modified requirements are required, HCDE and Grantee agree that a formal amendment to the NOGA is not required, but the modified insurance requirements shall become effective upon written notice to Grantee.

**Regular Board Meeting**

**8.E.1.**

**Meeting Date:** July 21, 2021

**Title:** Contract renewal for 18/061JN JOC-IDIQ For Modular Buildings & Related Items

**Submitted For:** Joann Nichols, Choice Partners

**Submitted By:** Cora Day

**Recommended Action:** Approve

**HCDE Goal(s):** 4. Provide cost savings by leveraging tax dollars

**Additional Resource Personnel:** Joann Nichols, Jeff Drury, Richard Vela, Yaritza Roman, Kendra Jackson and Dr. Jesus Amezcua

**Facilities/Technology Approval Needed?:** None

**Information**

**Posted Agenda Item:**

**Approval of Contract Renewal option for job no. 18/061JN for JOC-IDIQ for Modular Buildings & Related Items with the following vendors:** Aries Building Systems, LLC (#18/061JN-01), and JR Thomas Group, Inc. (#18/061JN-03) for the period 08/15/2021 through 08/14/2022.

**Subject:**

Choice Partners; Contract Renewal; JOC-IDIQ for Modular Buildings & Related Items; Revenue Generating

**Rationale:**

The process enacted was Competitive Sealed Proposals (CSP). Two hundred-fifty (250) invitations were extended for proposals. Seven (7) responses were received of which three (3) were non-awarded, and four (4) were awarded. HCDE/Choice Partners contract no. 18/061JN was awarded for two (2) years from 08/15/2018 to 08/14/2020. The contract has the option for three (3) annual renewals.

HCDE/Choice Partners recommends exercising the second (2nd) option for renewal period 08/15/2021 to 08/14/2022 for the vendors listed above in Posted Agenda Item. Anticipated revenue from contract no. 18/061JN will be an administrative fee of two percent (2%). This contract is governed by Texas Education Code 44.031 and Texas Government Code 2269.

**Fiscal Impact**

**Included in FY budget Y/N:** Y

**Included in current budget amendment Y/N:** N

**Attachments**

Aries  
JR Thomas Group

**Form Review**

Inbox	Reviewed By	Date
Choice Partners	Jeff Drury	06/24/2021 05:16 PM
Purchasing	Kendra Jackson	06/30/2021 07:51 AM
Assistant Superintendent - Business	Venetia Baldwin	07/06/2021 09:58 AM

June 10, 2021

**Subject: Contract Renewal for # 18/061JN for Job Order Contracting (JOC) for IDIQ Modular Buildings and Related Items for Harris Department of Education (HCDE)/Choice Partners Cooperative**

Dear CP Vendor Partner:

Your contract with Choice Partners (CP), a division of Harris County Department of Education (HCDE) is scheduled to expire **August 14, 2021**. This contract has **one (1)** one-year annual renewal options remaining before final expiration. Choice Partners values this contract and is exercising the option to extend this contract for one (1) year beginning **August 15, 2021**.

If you agree to renew this contract, please complete, sign and attach this letter under the "Response Attachments" section of the Choice Partners eBid System <http://www.choicepartners.org/vendor-login.php> **June 22, 2021 at 2:00 p.m. central time.**

In addition, provide any updated pricing and/or discounts for your contract and attach a current copy of your certificate of insurance (if applicable) and any forms that may have changed since the original proposal was submitted.

If you have any questions or concerns, or need to discuss this contract renewal please contact Cora Day at 713-696-8208 or e-mail to [cora@choicepartners.org](mailto:cora@choicepartners.org).

Sincerely,

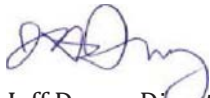

Jeff Drury, Director  
Choice Partners  
A division of Harris County Department of Education

Jesus J. Amezcua, PhD., CPA, RTSBA  
Assistant Superintendent for Business Services  
Harris County Department of Education

The individual signing below has authority to enter into this agreement on behalf of the Vendor.

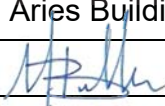
Corporate Name:	Aries Building Systems, LLC
Authorized Signature:	
Print Name:	Michael Bollero, Jr.
Title:	President
Date:	06/22/2021
Address:	12600 Featherwood Dr., Ste. 450
City, State, Zip Code:	Houston, TX 77034
Phone:	281-448-2800
Email Address:	mbj@ariesbuildings.com



June 10, 2021

**Subject: Contract Renewal for # 18 / 061JN for Job Order Contracting (JOC) for IDIQ Modular Buildings and Related Items for Harris Department of Education (HCDE)/Choice Partners Cooperative**

Dear CP Vendor Partner:

Your contract with Choice Partners (CP), a division of Harris County Department of Education (HCDE) is scheduled to expire **August 14, 2021**. This contract has **one (1)** one-year annual renewal options remaining before final expiration. Choice Partners values this contract and is exercising the option to extend this contract for one (1) year beginning **August 15, 2021**.

If you agree to renew this contract, please complete, sign and attach this letter under the "Response Attachments" section of the Choice Partners eBid System <http://www.choicepartners.org/vendor-login.php> **June 22, 2021 at 2:00 p.m. central time.**

In addition, provide any updated pricing and/or discounts for your contract and attach a current copy of your certificate of insurance (if applicable) and any forms that may have changed since the original proposal was submitted.

If you have any questions or concerns, or need to discuss this contract renewal please contact Cora Day at 713-696-8208 or e-mail to [cora@choicepartners.org](mailto:cora@choicepartners.org).

Sincerely,



Jeff Drury, Director  
Choice Partners  
A division of Harris County Department of Education

Jesus J. Amezcua, PhD., CPA, RTSBA  
Assistant Superintendent for Business Services  
Harris County Department of Education

The individual signing below has authority to enter into this agreement on behalf of the Vendor.

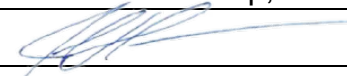
Corporate Name:	JR Thomas Group, Inc.
Authorized Signature:	
Print Name:	John R Thomas
Title:	President
Date:	June 22, 2021
Address:	2616 South Loop West, Suite 473
City, State, Zip Code:	Houston, Texas 77054
Phone:	713-485-0805
Email Address:	Jthomas@tgmhouston.com



**Regular Board Meeting**

**8.E.2.**

**Meeting Date:** July 21, 2021  
**Title:** Contract Renewal for 19/047KC for Communications, Creative and Marketing Services & Related Services  
**Submitted For:** Joann Nichols, Choice Partners  
**Submitted By:** Cora Day  
**Recommended Action:** Approve  
**HCDE Goal(s):** 4. Provide cost savings by leveraging tax dollars  
**Additional Resource Personnel:** Joann Nichols, Jeff Drury, Richard Vela, Yaritza Roman, Kendra Jackson and Dr. Jesus Amezcua  
**Facilities/Technology Approval Needed?:** None

**Information**

**Posted Agenda Item:**

**Approval of Contract Renewal option for job no. 19/047KC for Communications, Creative and Marketing Services & Related Items with the following vendors:** Alboum & Associates dba Alboum Translation Services (#19/047KC-01); Love Advertising, Inc. (#19/047KC-03), and Versa Creative Group, Inc. (#19/047KC-04) for the period 08/21/2021 through 08/20/2022.

**Subject:**

Choice Partners; Contract Renewal; Communications, Creative and Marketing Services & Related Items; Revenue Generating

**Rationale:**

The process enacted was a Request for Proposal (RFP). Three hundred-twelve (312) invitations were extended for proposals. Six (6) responses were received of which two (2) were non-awarded, and four (4) were awarded. HCDE/Choice Partners contract no. 19/047KC was awarded for one (1) year from 08/21/2019 to 08/20/2020. The contract has the option for three (3) annual renewals.

HCDE/Choice Partners recommends exercising the second (2nd) option for renewal period 08/21/2021 to 08/20/2022 for the vendors listed above in Posted Agenda Item. Anticipated revenue from contract no. 19/047KC will be an administrative fee of two percent (2%). This contract is governed by Texas Education Code 44.031.

**Fiscal Impact**

**Included in FY budget Y/N:** Y  
**Included in current budget amendment Y/N:** N

**Attachments**

Alboum  
Love Advertising  
Versa

**Form Review**

<b>Inbox</b>	<b>Reviewed By</b>	<b>Date</b>
Choice Partners	Jeff Drury	06/24/2021 05:13 PM

June 10, 2021

**Subject: Contract Renewal for # 19 / 0 4 7 K C f o r C o m m u n i c a t i o n s , C r e a t i v e & M a r k e t i n g S e r v i c e s & R e l a t e d I t e m s f o r H a r r i s D e p a r t m e n t o f E d u c a t i o n (H C D E) / C h o i c e P a r t n e r s C o o p e r a t i v e**

Dear CP Vendor Partner:

Your contract with Choice Partners (CP), a division of Harris County Department of Education (HCDE) is scheduled to expire **August 20, 2021**. This contract has **two (2)** one-year annual renewal options remaining before final expiration. Choice Partners values this contract and is exercising the option to extend this contract for one year beginning **August 21, 2021**.

If you agree to renew this contract, please complete, sign and attach this letter under the "Response Attachments" section of the Choice Partners eBid System <http://www.choicepartners.org/vendor-login.php> **by June 22, 2021 at 2:00 p.m. central time.**

In addition, provide any updated pricing and/or discounts for your contract and attach a current copy of your certificate of insurance (if applicable) and any forms that may have changed since the original proposal was submitted.

If you have any questions or concerns, or need to discuss this contract renewal please contact Cora Day at 713-696-8208 or e-mail to [cora@choicepartners.org](mailto:cora@choicepartners.org).

Sincerely,



Jeff Drury, Director  
Choice Partners  
A division of Harris County Department of Education

Jesus J. Amezcua, PhD., CPA, RTSBA  
Assistant Superintendent for Business Services  
Harris County Department of Education

The individual signing below has authority to enter into this agreement on behalf of the Vendor.

Corporate Name:	Albourn & Associates LLC dba Albourn Translation Services
Authorized Signature:	
Print Name:	Sandra Albourn
Title:	Founder & CEO
Date:	June 14, 2021
Address:	1835 N Kirkwood Place
City, State, Zip Code:	Arlington, VA 22201
Phone:	571-765-3060
Email Address:	sandra@albourn.com



June 10, 2021

**Subject: Contract Renewal for # 19 / 0 47KC for Communications, Creative & Marketing Services & Related Items for Harris Department of Education (HCDE)/Choice Partners Cooperative**

Dear CP Vendor Partner:

Your contract with Choice Partners (CP), a division of Harris County Department of Education (HCDE) is scheduled to expire **August 20, 2021**. This contract has **two (2)** one-year annual renewal options remaining before final expiration. Choice Partners values this contract and is exercising the option to extend this contract for one year beginning **August 21, 2021**.

If you agree to renew this contract, please complete, sign and attach this letter under the "Response Attachments" section of the Choice Partners eBid System <http://www.choicepartners.org/vendor-login.php> by **June 22, 2021 at 2:00 p.m. central time**.

In addition, provide any updated pricing and/or discounts for your contract and attach a current copy of your certificate of insurance (if applicable) and any forms that may have changed since the original proposal was submitted.

If you have any questions or concerns, or need to discuss this contract renewal please contact Cora Day at 713-696-8208 or e-mail to [cora@choicepartners.org](mailto:cora@choicepartners.org).

Sincerely,



Jeff Drury, Director  
Choice Partners  
A division of Harris County Department of Education

Jesus J. Amezcua, PhD., CPA, RTSBA  
Assistant Superintendent for Business Services  
Harris County Department of Education

The individual signing below has authority to enter into this agreement on behalf of the Vendor.

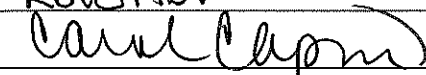
Corporate Name:	Love ADV
Authorized Signature:	
Print Name:	Carol Caposino
Title:	Production Director
Date:	06/22/2021
Address:	3550 W 12th St
City, State, Zip Code:	Houston TX 77008
Phone:	713-552-1055
Email Address:	carol@loveadv.com



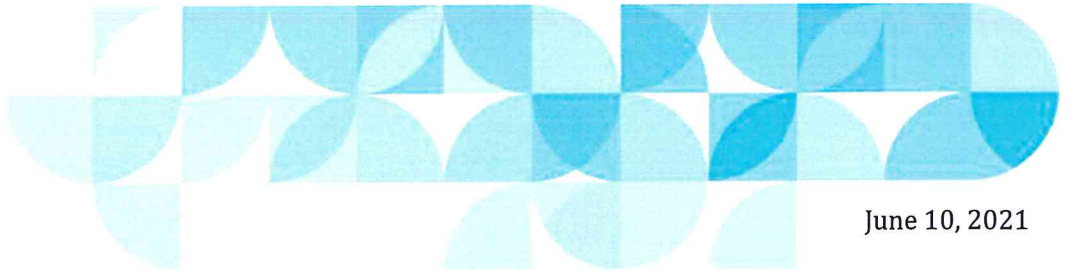

June 10, 2021

**Subject: Contract Renewal for # 19 / 0 47 KC for Communications, Creative & Marketing Services & Related Items for Harris Department of Education (HCDE)/Choice Partners Cooperative**

Dear CP Vendor Partner:

Your contract with Choice Partners (CP), a division of Harris County Department of Education (HCDE) is scheduled to expire **August 20, 2021**. This contract has **two (2)** one-year annual renewal options remaining before final expiration. Choice Partners values this contract and is exercising the option to extend this contract for one year beginning **August 21, 2021**.

If you agree to renew this contract, please complete, sign and attach this letter under the "Response Attachments" section of the Choice Partners eBid System <http://www.choicepartners.org/vendor-login.php> **by June 22, 2021 at 2:00 p.m. central time.**

In addition, provide any updated pricing and/or discounts for your contract and attach a current copy of your certificate of insurance (if applicable) and any forms that may have changed since the original proposal was submitted.

If you have any questions or concerns, or need to discuss this contract renewal please contact Cora Day at 713-696-8208 or e-mail to [cora@choicepartners.org](mailto:cora@choicepartners.org).

Sincerely,

  
Jeff Drury, Director  
Choice Partners  
A division of Harris County Department of Education

Jesus J. Amezcua, PhD., CPA, RTSBA  
Assistant Superintendent for Business Services  
Harris County Department of Education

The individual signing below has authority to enter into this agreement on behalf of the Vendor.

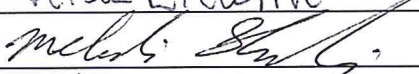
Corporate Name:	Versa Creative
Authorized Signature:	
Print Name:	Eddie Shekari
Title:	CEO
Date:	6/16/2021
Address:	5444 Westheimer Rd
City, State, Zip Code:	Houston, TX, 77056
Phone:	832-831-7590
Email Address:	eshekari@versacreative.com





**Regular Board Meeting**

**8.E.3.**

**Meeting Date:** July 21, 2021

**Title:** Contract Renewal for 19/048MR for Pest, Lawn, Pool Chemical Supplies & Services

**Submitted For:** Joann Nichols, Choice Partners

**Submitted By:** Cora Day

**Recommended Action:** Approve

**HCDE Goal(s):** 4. Provide cost savings by leveraging tax dollars

**Additional Resource Personnel:** Joann Nichols, Jeff Drury, Richard Vela, Yaritza Roman, Kendra Jackson and Dr. Jesus Amezcua

**Facilities/Technology Approval Needed?:** None

**Information**

**Posted Agenda Item:**

**Approval of Contract Renewal option for job no. 19/048MR for Pest, Lawn, Pool Chemical Supplies & Services with the following vendors:** Copesan Service, Inc. dba Holder's Pest Solutions (#19/048MR-01), and JR Simplot Company dba Simplot (#19/048MR-02) for the period 08/21/2021 through 08/20/2022.

**Subject:**

Choice Partners; Contract Renewal; Pest, Lawn, Pool Chemical Supplies & Services; Revenue Generating

**Rationale:**

The process enacted was a Request for Proposal (RFP). Four hundred eighty-four (484) invitations were extended for proposals. Four (4) responses were received of which one (1) was deemed non-responsive, one (1) was non-awarded, and two (2) were awarded. HCDE/Choice Partners contract no. 19/048MR was awarded for one (1) year from 08/21/2019 to 08/20/2020. The contract has the option for three (3) annual renewals.

HCDE/Choice Partners recommends exercising the second (2nd) option for renewal period 08/21/2021 to 08/20/2022 for the vendors listed above in Posted Agenda Item. Anticipated revenue from contract no. 19/048MR will be an administrative fee of two percent (2%). This contract is governed by Texas Education Code 44.031.

**Fiscal Impact**

**Included in FY budget Y/N:** Y

**Included in current budget amendment Y/N:** N

**Attachments**

Holder's Pest  
Simplot

**Form Review**

**Inbox**  
Choice Partners  
Purchasing

**Reviewed By**  
Jeff Drury  
Kendra Jackson

**Date**  
06/24/2021 05:15 PM  
06/29/2021 07:07 PM

June 10, 2021

**Subject: Contract Renewal for # 19 / 0 4 8 MR f o r P e s t / L a w n / P o o l C h e m i c a l S u p p l i e s & R e l a t e d I t e m s f o r H a r r i s D e p a r t m e n t o f E d u c a t i o n ( H C D E ) / C h o i c e P a r t n e r s C o o p e r a t i v e**

Dear CP Vendor Partner:

Your contract with Choice Partners (CP), a division of Harris County Department of Education (HCDE) is scheduled to expire **August 20, 2021**. This contract has **two (2)** one-year annual renewal options remaining before final expiration. Choice Partners values this contract and is exercising the option to extend this contract for one year beginning **August 21, 2021**.

If you agree to renew this contract, please complete, sign and attach this letter under the "Response Attachments" section of the Choice Partners eBid System <http://www.choicepartners.org/vendor-login.php> **by June 22, 2021 at 2:00 p.m. central time.**

In addition, provide any updated pricing and/or discounts for your contract and attach a current copy of your certificate of insurance (if applicable) and any forms that may have changed since the original proposal was submitted.

If you have any questions or concerns, or need to discuss this contract renewal please contact Cora Day at 713-696-8208 or e-mail to [cora@choicepartners.org](mailto:cora@choicepartners.org).

Sincerely,



Jeff Drury, Director  
Choice Partners  
A division of Harris County Department of Education

Jesus J. Amezcua, PhD., CPA, RTSBA  
Assistant Superintendent for Business Services  
Harris County Department of Education

The individual signing below has authority to enter into this agreement on behalf of the Vendor.

Corporate Name:	<b>Copesan Services Inc / Holder's Pest Solutions</b>
Authorized Signature:	<i>Anthony Acevedo</i>
Print Name:	<b>Anthony Acevedo</b>
Title:	<b>Commercial Account Manager</b>
Date:	<b>6/21/2021</b>
Address:	<b>4407 Halik St E500</b>
City, State, Zip Code:	<b>Pearland Tx, 77581</b>
Phone:	<b>281-541-1584</b>
Email Address:	<b>aacevedo@holderspeastsolutions.com</b>



June 10, 2021

**Subject: Contract Renewal for # 19/048MR for Pest/Lawn/Pool Chemical Supplies & Related Items for Harris Department of Education (HCDE)/Choice Partners Cooperative**

Dear CP Vendor Partner:

Your contract with Choice Partners (CP), a division of Harris County Department of Education (HCDE) is scheduled to expire **August 20, 2021**. This contract has **two (2)** one-year annual renewal options remaining before final expiration. Choice Partners values this contract and is exercising the option to extend this contract for one year beginning **August 21, 2021**.

If you agree to renew this contract, please complete, sign and attach this letter under the "Response Attachments" section of the Choice Partners eBid System <http://www.choicepartners.org/vendor-login.php> **by June 22, 2021 at 2:00 p.m. central time.**

In addition, provide any updated pricing and/or discounts for your contract and attach a current copy of your certificate of insurance (if applicable) and any forms that may have changed since the original proposal was submitted.

If you have any questions or concerns, or need to discuss this contract renewal please contact Cora Day at 713-696-8208 or e-mail to [cora@choicepartners.org](mailto:cora@choicepartners.org).

Sincerely,



Jeff Drury, Director  
Choice Partners  
A division of Harris County Department of Education

Jesus J. Amezcua, PhD., CPA, RTSBA  
Assistant Superintendent for Business Services  
Harris County Department of Education

The individual signing below has authority to enter into this agreement on behalf of the Vendor.

Corporate Name:	<i>Simplot Tilt &amp; Horticulture</i>
Authorized Signature:	<i>[Handwritten Signature]</i>
Print Name:	<i>Jay Blodgett</i>
Title:	<i>Sales Rep</i>
Date:	<i>6/23/2022</i>
Address:	<i>1755 Transcentral Ct, # 100</i>
City, State, Zip Code:	<i>Houston, TX 77032</i>
Phone:	<i>281 726 3485</i>
Email Address:	<i>jay.blodgett@simplot.com</i>



**Regular Board Meeting**

**8.E.4.**

**Meeting Date:** July 21, 2021  
**Title:** Contract Renewal for 19/051TP Frozen Dessert Products  
**Submitted For:** Jeff Drury, Choice Partners **Submitted By:** Melissa Wilder  
**Recommended Action:** **HCDE Goal(s):**  
**Additional Resource** **Facilities/Technology**  
**Personnel:** **Approval Needed?:**

**Information**

**Posted Agenda Item:**

**Approval of Contract Renewal option for job no. 19/051TP Frozen Dessert Products with the following vendors:** Dippin' Dots (19/051TP-02), and Southern Ice Cream (19/051TP-03) for the period 08/22/2021 through 08/21/2022.

**Subject:**

Choice Partners; Contract Renewal; Food Contract; Revenue Generating

**Rationale:**

The process enacted was Request for Proposals. Two hundred ninety-one (291) invitations were extended for proposals. Four (4) responses were received and three (3) were awarded. HCDE/Choice Partners contract no. 19/051TP was awarded for one (1) year from 08/22/2019 to 08/21/2020. The contract has the option for three (3) annual renewals.

HCDE/Choice Partners recommends exercising the second (2nd) option for renewal period 08/22/2021 to 08/21/2022 for the vendors listed above in Posted Agenda Item. Anticipated revenue from contract no. 19/051TP will be an administrative fee of one percent (1%). This contract is governed by Texas Education Code 44.031.

**Fiscal Impact**

**Included in FY budget Y/N:** Y  
**Included in current budget amendment Y/N:** N

**Attachments**

Dippin' Dots Renewal Letter  
Southern Ice Cream Renewal Letter

**Form Review**

<b>Inbox</b>	<b>Reviewed By</b>	<b>Date</b>
Choice Partners	Joann Nichols	06/28/2021 09:10 AM
Purchasing	Kendra Jackson	06/30/2021 08:09 AM
Assistant Superintendent - Business	Venetia Baldwin	07/06/2021 09:58 AM
Form Started By: Melissa Wilder		Started On: 06/25/2021 10:12 AM
Final Approval Date: 07/06/2021		

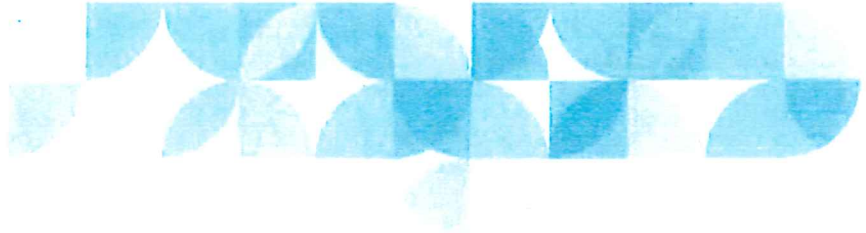

April 7, 2021

**Subject: Contract Renewal for 19/051TP Frozen Dessert Products for Harris County Department of Education (HCDE)/Choice Partners Cooperative**

Dear CP Vendor Partner:

Your contract with Choice Partners (CP), a division of Harris County Department of Education (HCDE) is scheduled to expire **August 21, 2021**. This contract has two (2), one-year annual renewal options remaining before final expiration. Choice Partners values this contract and is exercising the option to extend this contract for one year beginning **August 22, 2021**.

If you agree to renew this contract, please complete, sign and attach this letter under the "Response Attachments" section of the Choice Partners eBid System at <https://hcdeebid.ionwave.net/CurrentSourcingEvents.aspx> by June 17, 2021 at 2:00 pm (CST).

In addition, provide any updated pricing and/or discounts for your contract and attach a current copy of your certificate of insurance (if applicable) and any forms that may have changed since the original proposal was submitted.

If you have any questions or concerns, or need to discuss this contract renewal please contact Laura Sprehe at 713-696-8213 or e-mail to [laura@choicepartners.org](mailto:laura@choicepartners.org)

Sincerely,

Jeff Drury, Director  
Choice Partners  
A division of Harris County Department of Education

Jesus J. Amezcua, PhD., CPA, RTSBA  
Assistant Superintendent for Business Services  
Harris County Department of Education

The individual signing below has authority to enter into this agreement on behalf of the Vendor.

Corporate Name:	Dippin' Dots LLC
Authorized Signature:	
Print Name:	Steve Heisner
Title:	V.P. of HR
Date:	6/4/21
Address:	5101 Charter Oak Drive
City, State, Zip Code:	Rockwall, TX 75087
Phone:	270-415-3184
Email Address:	sarbra@dippindots.com



April 7, 2021

**Subject: Contract Renewal for 19/051TP Frozen Dessert Products for Harris County Department of Education (HCDE)/Choice Partners Cooperative**

Dear CP Vendor Partner:

Your contract with Choice Partners (CP), a division of Harris County Department of Education (HCDE) is scheduled to expire **August 21, 2021**. This contract has two (2), one-year annual renewal options remaining before final expiration. Choice Partners values this contract and is exercising the option to extend this contract for one year beginning **August 22, 2021**.

If you agree to renew this contract, please complete, sign and attach this letter under the "Response Attachments" section of the Choice Partners eBid System at <https://hcdeebid.ionwave.net/CurrentSourcingEvents.aspx> by **June 17, 2021 at 2:00 pm (CST)**.

In addition, provide any updated pricing and/or discounts for your contract and attach a current copy of your certificate of insurance (if applicable) and any forms that may have changed since the original proposal was submitted.

If you have any questions or concerns, or need to discuss this contract renewal please contact Laura Sprehe at 713-696-8213 or e-mail to [laura@choicepartners.org](mailto:laura@choicepartners.org)

Sincerely,

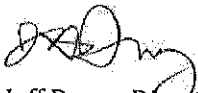
  
Jeff Drury, Director  
Choice Partners  
A division of Harris County Department of Education

Jesus J. Amezcua, PhD., CPA, RTSBA  
Assistant Superintendent for Business Services  
Harris County Department of Education

The individual signing below has authority to enter into this agreement on behalf of the Vendor.

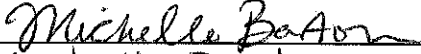
Corporate Name:	Southern Ice Cream
Authorized Signature:	
Print Name:	Michelle Barton
Title:	President
Date:	6/4/21
Address:	13755 Greenland Drive
City, State, Zip Code:	Stafford, TX 77477
Phone:	281-499-9837
Email Address:	michelle@southernicecreamtx.com



**Regular Board Meeting**

**8.E.5.**

**Meeting Date:** July 21, 2021  
**Title:** Contract Renewal for 20/046SG for Award Jackets, Apparel, Screen Printing, and Embroidery  
**Submitted For:** Joann Nichols, Choice Partners  
**Submitted By:** Cora Day  
**Recommended Action:** Approve  
**HCDE Goal(s):** 4. Provide cost savings by leveraging tax dollars  
**Additional Resource Personnel:** Joann Nichols, Jeff Drury, Richard Vela, Yaritza Roman, Kendra Jackson and Dr. Jesus Amezcua  
**Facilities/Technology Approval Needed?:** None

**Information**

**Posted Agenda Item:**

**Approval of Contract Renewal option for job no. 20/046SG for Award Jackets, Apparel, Screen Printing and Embroidery with the following vendors** 4imprint, Inc. (#20/046SG-01); Balfour Company (#20/046SG-04); Buffalo Specialties, Inc. (#20/046SG-05); JW Drouin & Associates dba J. Harding & Co. (#20/046SG-08); Marketing Magic International, Ltd (#20/046SG-09); Tejas Office Products, Inc. (#20/046SG-12); Texas Music Festivals Enterprise, Inc. (#20/046SG-13), and Trademarks Promotional Products, LP (#20/046SG-14) for the period 08/19/2021 through 08/18/2022.

**Subject:**

Choice Partners; Contract Renewal; Award Jackets, Apparel, Screen Printing and Embroidery; Revenue Generating

**Rationale:**

The process enacted was a Request for Proposal (RFP). Eight hundred sixty-nine (869) invitations were extended for proposals. Thirty (30) responses were received of which one (1) vendor was determined to be non-responsive, fifteen (15) were non-awarded, and fourteen (14) were awarded. HCDE/Choice Partners contract no. 20/046SG was awarded for one (1) year from 08/19/2020 to 08/18/2021. The contract has the option for three (3) annual renewals.

HCDE/Choice Partners recommends exercising the first (1st) option for renewal period 08/19/2021 to 08/18/2022 for the vendors listed above in Posted Agenda Item. Anticipated revenue from contract no. 20/046SG will be an administrative fee of two percent (2%). This contract is governed by Texas Education Code 44.031.

**Fiscal Impact**

**Included in FY budget Y/N:** Y  
**Included in current budget amendment Y/N:** N

**Attachments**

- 4imprint
- Balfour Company
- Buffalo Specialties
- J Harding

June 10, 2021

**Subject: Contract Renewal for # 20 / 046SG for Award Jackets, Apparel, Screen Printing, and Embroidery for Harris Department of Education (HCDE)/Choice Partners Cooperative**

Dear CP Vendor Partner:

Your contract with Choice Partners (CP), a division of Harris County Department of Education (HCDE) is scheduled to expire **August 18, 2021**. This contract has **three (3)** one-year annual renewal options remaining before final expiration. Choice Partners values this contract and is exercising the option to extend this contract for one year beginning **August 19, 2021**.

If you agree to renew this contract, please complete, sign and attach this letter under the "Response Attachments" section of the Choice Partners eBid System <http://www.choicepartners.org/vendor-login.php> **June 22, 2021 at 2:00 p.m. central time.**

In addition, provide any updated pricing and/or discounts for your contract and attach a current copy of your certificate of insurance (if applicable) and any forms that may have changed since the original proposal was submitted.

If you have any questions or concerns, or need to discuss this contract renewal please contact Cora Day at 713-696-8208 or e-mail to [cora@choicepartners.org](mailto:cora@choicepartners.org).

Sincerely,



Jeff Drury, Director  
Choice Partners  
A division of Harris County Department of Education

Jesus J. Amezcua, PhD., CPA, RTSBA  
Assistant Superintendent for Business Services  
Harris County Department of Education

The individual signing below has authority to enter into this agreement on behalf of the Vendor.

Corporate Name:	4imprint, Inc.
Authorized Signature:	<i>Shay Freund</i>
Print Name:	Shay Freund
Title:	Sr. Bid Representative
Date:	06/15/2021
Address:	101 Commerce St.
City, State, Zip Code:	Oshkosh, WI 54901
Phone:	877-446-7746
Email Address:	Bids@4imprint.com





June 10, 2021

**Subject: Contract Renewal for #20/046SG for Award Jackets, Apparel, Screen Printing, and Embroidery for Harris Department of Education (HCDE)/Choice Partners Cooperative**

Dear CP Vendor Partner:

Your contract with Choice Partners (CP), a division of Harris County Department of Education (HCDE) is scheduled to expire **August 18, 2021**. This contract has **three (3)** one-year annual renewal options remaining before final expiration. Choice Partners values this contract and is exercising the option to extend this contract for one year beginning **August 19, 2021**.

If you agree to renew this contract, please complete, sign and attach this letter under the "Response Attachments" section of the Choice Partners eBid System <http://www.choicepartners.org/vendor-login.php> **June 22, 2021 at 2:00 p.m. central time**.

In addition, provide any updated pricing and/or discounts for your contract and attach a current copy of your certificate of insurance (if applicable) and any forms that may have changed since the original proposal was submitted.

If you have any questions or concerns, or need to discuss this contract renewal please contact Cora Day at 713-696-8208 or e-mail to [cora@choicepartners.org](mailto:cora@choicepartners.org).

Sincerely,

  
 Jeff Drury, Director  
 Choice Partners  
 A division of Harris County Department of Education

Jesus J. Amezcua, PhD., CPA, RTSBA  
 Assistant Superintendent for Business Services  
 Harris County Department of Education

The individual signing below has authority to enter into this agreement on behalf of the Vendor.

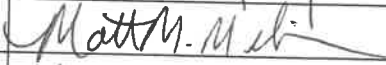
Corporate Name:	Balfour Company
Authorized Signature:	
Print Name:	Matt M. Miller
Title:	Sales Representative
Date:	6/14/2021
Address:	8525 Westland West Blvd.
City, State, Zip Code:	Houston, TX 77041
Phone:	832 912 8000
Email Address:	MattM@balfourhouston.com



June 10, 2021

**Subject: Contract Renewal for # 20 / 046SG for Award Jackets, Apparel, Screen Printing, and Embroidery for Harris Department of Education (HCDE)/Choice Partners Cooperative**

Dear CP Vendor Partner:

Your contract with Choice Partners (CP), a division of Harris County Department of Education (HCDE) is scheduled to expire **August 18, 2021**. This contract has **three (3)** one-year annual renewal options remaining before final expiration. Choice Partners values this contract and is exercising the option to extend this contract for one year beginning **August 19, 2021**.

If you agree to renew this contract, please complete, sign and attach this letter under the "Response Attachments" section of the Choice Partners eBid System <http://www.choicepartners.org/vendor-login.php> **June 22, 2021 at 2:00 p.m. central time.**

In addition, provide any updated pricing and/or discounts for your contract and attach a current copy of your certificate of insurance (if applicable) and any forms that may have changed since the original proposal was submitted.

If you have any questions or concerns, or need to discuss this contract renewal please contact Cora Day at 713-696-8208 or e-mail to [cora@choicepartners.org](mailto:cora@choicepartners.org).

Sincerely,



Jeff Drury, Director  
Choice Partners  
A division of Harris County Department of Education

Jesus J. Amezcua, PhD., CPA, RTSBA  
Assistant Superintendent for Business Services  
Harris County Department of Education

The individual signing below has authority to enter into this agreement on behalf of the Vendor.

Corporate Name:	BUFFALO SPECIALTIES, INC.
Authorized Signature:	<i>Teresa Ryerson</i>
Print Name:	Teresa Ryerson
Title:	Senior Account Representative
Date:	6/18/2021
Address:	10502 Fallstone Rd.
City, State, Zip Code:	Houston, TX 77099
Phone:	713-271-6107 X118
Email Address:	tryerson@buffspec.com



June 10, 2021

**Subject: Contract Renewal for #20/046SG for Award Jackets, Apparel, Screen Printing, and Embroidery for Harris Department of Education (HCDE)/Choice Partners Cooperative**

Dear CP Vendor Partner:

Your contract with Choice Partners (CP), a division of Harris County Department of Education (HCDE) is scheduled to expire **August 18, 2021**. This contract has **three (3)** one-year annual renewal options remaining before final expiration. Choice Partners values this contract and is exercising the option to extend this contract for one year beginning **August 19, 2021**.

If you agree to renew this contract, please complete, sign and attach this letter under the "Response Attachments" section of the Choice Partners eBid System <http://www.choicepartners.org/vendor-login.php> **June 22, 2021 at 2:00 p.m. central time.**

In addition, provide any updated pricing and/or discounts for your contract and attach a current copy of your certificate of insurance (if applicable) and any forms that may have changed since the original proposal was submitted.

If you have any questions or concerns, or need to discuss this contract renewal please contact Cora Day at 713-696-8208 or e-mail to [cora@choicepartners.org](mailto:cora@choicepartners.org).

Sincerely,

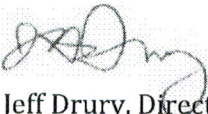

Jeff Drury, Director  
 Choice Partners  
 A division of Harris County Department of Education

Jesus J. Amezcua, PhD., CPA, RTSBA  
 Assistant Superintendent for Business Services  
 Harris County Department of Education

The individual signing below has authority to enter into this agreement on behalf of the Vendor.

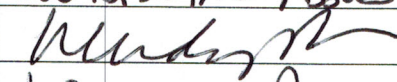
Corporate Name:	JW Dravin Assoc dba J Harding & Co
Authorized Signature:	
Print Name:	Wendy Dravin
Title:	Managing partner
Date:	6-19-21
Address:	424 W 19th
City, State, Zip Code:	Houston TX 77008
Phone:	713-862-9855
Email Address:	Wendy@jharding.com



June 10, 2021

**Subject: Contract Renewal for # 20 / 046SG for Award Jackets, Apparel, Screen Printing, and Embroidery for Harris Department of Education (HCDE)/Choice Partners Cooperative**

Dear CP Vendor Partner:

Your contract with Choice Partners (CP), a division of Harris County Department of Education (HCDE) is scheduled to expire **August 18, 2021**. This contract has **three (3)** one-year annual renewal options remaining before final expiration. Choice Partners values this contract and is exercising the option to extend this contract for one year beginning **August 19, 2021**.

If you agree to renew this contract, please complete, sign and attach this letter under the "Response Attachments" section of the Choice Partners eBid System <http://www.choicepartners.org/vendor-login.php> **June 22, 2021 at 2:00 p.m. central time.**

In addition, provide any updated pricing and/or discounts for your contract and attach a current copy of your certificate of insurance (if applicable) and any forms that may have changed since the original proposal was submitted.

If you have any questions or concerns, or need to discuss this contract renewal please contact Cora Day at 713-696-8208 or e-mail to [cora@choicepartners.org](mailto:cora@choicepartners.org).

Sincerely,

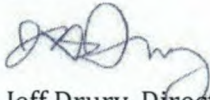
  
Jeff Drury, Director  
Choice Partners  
A division of Harris County Department of Education

Jesus J. Amezcua, PhD., CPA, RTSBA  
Assistant Superintendent for Business Services  
Harris County Department of Education

The individual signing below has authority to enter into this agreement on behalf of the Vendor.

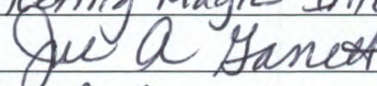
Corporate Name:	Marketing Magic International LTD
Authorized Signature:	
Print Name:	Jill A Garrett
Title:	General Partner, President
Date:	6/19/21
Address:	1622 Untola Ln
City, State, Zip Code:	League City Tx 77573
Phone:	832-642-5716
Email Address:	jgarrett@marketingm.com



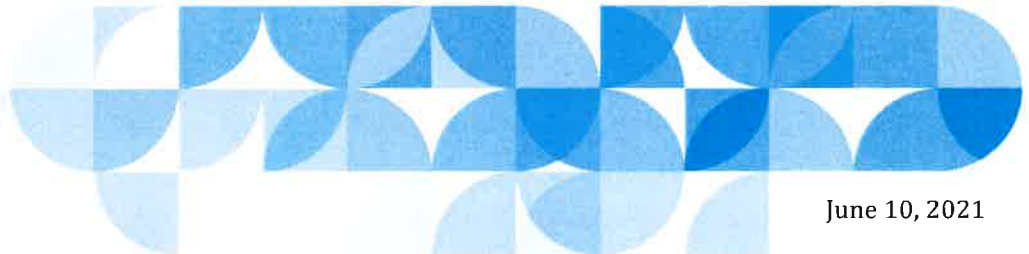

June 10, 2021

**Subject: Contract Renewal for # 20 / 046SG for Award Jackets, Apparel, Screen Printing, and Embroidery for Harris Department of Education (HCDE)/Choice Partners Cooperative**

Dear CP Vendor Partner:

Your contract with Choice Partners (CP), a division of Harris County Department of Education (HCDE) is scheduled to expire **August 18, 2021**. This contract has **three (3)** one-year annual renewal options remaining before final expiration. Choice Partners values this contract and is exercising the option to extend this contract for one year beginning **August 19, 2021**.

If you agree to renew this contract, please complete, sign and attach this letter under the "Response Attachments" section of the Choice Partners eBid System <http://www.choicepartners.org/vendor-login.php> **June 22, 2021 at 2:00 p.m. central time**.

In addition, provide any updated pricing and/or discounts for your contract and attach a current copy of your certificate of insurance (if applicable) and any forms that may have changed since the original proposal was submitted.

If you have any questions or concerns, or need to discuss this contract renewal please contact Cora Day at 713-696-8208 or e-mail to [cora@choicepartners.org](mailto:cora@choicepartners.org).

Sincerely,

Jeff Drury, Director  
Choice Partners  
A division of Harris County Department of Education

Jesus J. Amezcua, PhD., CPA, RTSBA  
Assistant Superintendent for Business Services  
Harris County Department of Education

The individual signing below has authority to enter into this agreement on behalf of the Vendor.

Corporate Name:	Tejas Office Products, Inc.
Authorized Signature:	
Print Name:	STEPHEN M. FRAGA
Title:	President
Date:	6/21/2021
Address:	1225 W. 20th St.
City, State, Zip Code:	Houston, TX 77008
Phone:	713-864-6004
Email Address:	stephenf@tejasoffice.com



June 10, 2021

**Subject: Contract Renewal for # 20 / 046SG for Award Jackets, Apparel, Screen Printing, and Embroidery for Harris Department of Education (HCDE)/Choice Partners Cooperative**

Dear CP Vendor Partner:

Your contract with Choice Partners (CP), a division of Harris County Department of Education (HCDE) is scheduled to expire **August 18, 2021**. This contract has **three (3)** one-year annual renewal options remaining before final expiration. Choice Partners values this contract and is exercising the option to extend this contract for one year beginning **August 19, 2021**.

If you agree to renew this contract, please complete, sign and attach this letter under the "Response Attachments" section of the Choice Partners eBid System <http://www.choicepartners.org/vendor-login.php> **June 22, 2021 at 2:00 p.m. central time.**

In addition, provide any updated pricing and/or discounts for your contract and attach a current copy of your certificate of insurance (if applicable) and any forms that may have changed since the original proposal was submitted.

If you have any questions or concerns, or need to discuss this contract renewal please contact Cora Day at 713-696-8208 or e-mail to [cora@choicepartners.org](mailto:cora@choicepartners.org).

Sincerely,

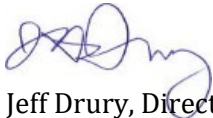

Jeff Drury, Director  
Choice Partners  
A division of Harris County Department of Education

Jesus J. Amezcua, PhD., CPA, RTSBA  
Assistant Superintendent for Business Services  
Harris County Department of Education

The individual signing below has authority to enter into this agreement on behalf of the Vendor.

Corporate Name:	Texas Music Festivals Enterprise, Inc.
Authorized Signature:	<i>Angela Flinchbaugh</i>
Print Name:	Angela Flinchbaugh
Title:	BID Coordinator
Date:	6/16/2021
Address:	216 East Business Highway 83
City, State, Zip Code:	San Juan, Texas 78589
Phone:	956-984-9468
Email Address:	angela@tmftoursandtravel.com



June 10, 2021

**Subject: Contract Renewal for # 20/046SG for Award Jackets, Apparel, Screen Printing, and Embroidery for Harris Department of Education (HCDE)/Choice Partners Cooperative**

Dear CP Vendor Partner:

Your contract with Choice Partners (CP), a division of Harris County Department of Education (HCDE) is scheduled to expire **August 18, 2021**. This contract has **three (3)** one-year annual renewal options remaining before final expiration. Choice Partners values this contract and is exercising the option to extend this contract for one year beginning **August 19, 2021**.

If you agree to renew this contract, please complete, sign and attach this letter under the "Response Attachments" section of the Choice Partners eBid System <http://www.choicepartners.org/vendor-login.php> **June 22, 2021 at 2:00 p.m. central time.**

In addition, provide any updated pricing and/or discounts for your contract and attach a current copy of your certificate of insurance (if applicable) and any forms that may have changed since the original proposal was submitted.

If you have any questions or concerns, or need to discuss this contract renewal please contact Cora Day at 713-696-8208 or e-mail to [cora@choicepartners.org](mailto:cora@choicepartners.org).

Sincerely,

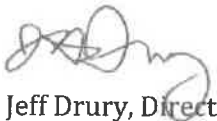

Jeff Drury, Director  
 Choice Partners  
 A division of Harris County Department of Education

Jesus J. Amezcua, PhD., CPA, RTSBA  
 Assistant Superintendent for Business Services  
 Harris County Department of Education

The individual signing below has authority to enter into this agreement on behalf of the Vendor.

Corporate Name:	Trademarks Promotional Products
Authorized Signature:	Kim Quinlan
Print Name:	Kim Quinlan
Title:	Account Executive
Date:	6-15-2021
Address:	11333 Todd Street
City, State, Zip Code:	Houston, TX 77085
Phone:	713-255-6543
Email Address:	kim@tmarks.com



**Regular Board Meeting**

**8.E.6.**

<b>Meeting Date:</b>	July 21, 2021		
<b>Title:</b>	Contract Award for 21/039MR for Job Order Contracting IDIQ Minor Construction		
<b>Submitted For:</b>	Joann Nichols, Choice Partners	<b>Submitted By:</b>	Cora Day
<b>Recommended Action:</b>	Approve	<b>HCDE Goal(s):</b>	4. Provide cost savings by leveraging tax dollars
<b>Additional Resource Personnel:</b>	Joann Nichols, Jeff Drury, Richard Vela, Yaritza Roman, Kendra Jackson and Dr. Jesus Amezcua	<b>Facilities/Technology Approval Needed?:</b>	None

**Information**

**Posted Agenda Item:**

**Approval of the Contract Award for job no. 21/039MR for Job Order Contracting IDIQ Minor Construction with the following vendors:** Aggieland Construction, Ltd (#21/039MR-01); Blue Ox Construction, Inc. (#21/039MR-02); Brown & Root Industrial Services, LLC (#21/039MR-03); RMB Management, LLC dba Corestone Construction Services (#21/039MR-04); Dura Pier Facilities Services, LTD dba Facilities Sources (#21/039MR-05); Falkenberg Construction Co., Inc. (#21/039MR-06); Flintco, LLC (#21/039MR-07); Generocity Services, Inc. (#21/039MR-08); H.B. Neild & Sons, Inc. (#21/039MR-09); Domingo V. Lopez, III dba JL Squared Construction (#21/039MR-10); Quad-Tex Construction, Inc. (#21/039MR-11); SDB, Inc. (#21/039MR-12); SterlingStructures, Inc. (#21/039MR-13); The Pounds Group, LLC dba Sullivan Contracting Services (#21/039MR-14); Texas General Contractors, Inc. (#21/039MR-15), and The Trevino Group, Inc. (#21/039MR-16) for the period 07/21/2021 through 07/20/2022.

**Subject:**

Choice Partners; New Award; Job Order Contracting IDIQ Minor Construction); Revenue Generating

**Rationale:**

The process enacted was Competitive Sealed Proposals (CSP) to acquire proposals from vendors to provide Maintenance Component (TEC 44.031) and Component for Job Order Contracting IDIQ Minor Construction, Maintenance, Repair, Alteration, Renovation, and Remediation services (Texas Government Code 2269) for Construction to HCDE/Choice Partners members.

One thousand ninety-five (1,095) invitations were extended for proposals. Forty-three (43) responses were received from vendors. The responses were reviewed for compliance with the requirements of CSP no. 21/039MR. All responses that met the criteria and requirements of the CSP were evaluated and scored. Fourteen (14) vendors were deemed non-responsive, thirteen (13) vendors were non-awarded, and sixteen (16) vendors offering best value to HCDE/Choice Partners and its members were selected for awards.

HCDE/Choice Partners recommends award of a one (1) year contract from 07/21/2021 to 07/20/2022 to the vendors stated above in Posted Agenda Item. Contract no. 21/039MR has the option for up to three (3) annual renewals. Anticipated revenue from contract no. 21/039MR will be an administrative fee of three percent (3%) for priced line items, and two percent (2%) for non-pre-priced line items on all sales made under this contract. This contract is governed by Texas Education Code 44.031 and Texas Government Code 2269.



---

---

### Fiscal Impact

Included in FY budget Y/N: Y  
Included in current budget amendment Y/N: N

---

---

### Attachments

Recommendation Report  
Evaluation Summary  
Participation Listing

---

---

### Form Review

**Inbox**

Choice Partners  
Purchasing  
Assistant Superintendent - Business  
Form Started By: Cora Day  
Final Approval Date: 07/06/2021

**Reviewed By**

Jeff Drury  
Kendra Jackson  
Venetia Baldwin

**Date**

06/24/2021 05:20 PM  
06/30/2021 07:58 AM  
07/06/2021 09:58 AM  
Started On: 06/16/2021 09:43 AM



**Harris County Department of Education  
Choice Partners  
Proposal Recommendation Form  
Program Review**

[This form is used to document due diligence by Recommendation Committee]

**To:** Purchasing Division  
**From:** Recommendation Committee

Stephen Kendrick HCDE  
Mary Causey Choice Partners  
Monique Joseph Choice Partners

Job (Bid or CSP#) and Name: 21/039MR Addendum 1 Job Order Contracting (IDIQ)  
Board Meeting Date: 7/21/2021  
Date: 6/8/2021

**Procurement Requirements Available:**

Check One

_____	Under \$2,500 (Requires Division Director and Asst Supt. Approval)
_____	From \$2,500 to \$50,000 (Requires Buyer, Purchasing Director/CFO Approval)
_____	Over \$50,000 (per CH Local)
_____ <u>X</u>	Cooperative Programs (Requires Board Approval)

I certify that I have reviewed the attached CSP and certify that all of my actions as a Recommendations Committee Member are within the procurement requirements in accordance with local Board Policies (CH local/legal) and legal (federal and state) policies and administrative guidelines set by the Business Office and Purchasing Division.

I certify that I have adhered to the Purchasing Policies of HCDE concerning the review of this CSP to include policies on conflict of interest (CIQ).

I certify that I am aware of all purchasing policies (CH Local and CH Legal) and administrative procedures of HCDE.

I certify that I am aware of the penalties of not following the purchasing policies and procedures and in specific with section 44.032 of the Texas Education Code which deals with the penalties related to sequential or component purchases.

I further certify that I recommend the execution of a contract after Board approval.

(Note: This form is required of all jobs (bids and CSPs) prepared by all buyers & Director)

**Justification:**

(Any information that pertains to this job (bid or CSP))

21/039MR Addendum 1 Job Order Contracting (IDIQ)

Choice Partners members will utilize this contract for Job Order Contracting (IDIQ)

This contract will provide a discounted price, superior quality, and comply with state purchasing requirements as stated in TEC §44.031 and Texas Government Code 2269.

This job was competitively bid and advertised. The result of the bid generated the following responses:

Invitations were sent to	1095	vendors
HCDE received	<u>43</u>	responses (see attached evaluation summary).

**Recommendation:**

HCDE is recommending with Choice Partners Cooperative for Aggieland Construction Ltd; Blue Ox Construction, Inc; Brown and Root Industrial Services, LLC; RMB Management, LLC dba Corestone Construction Services; Dura Pier Facilities Services Ltd dbaFacilities Sources; Falkenburg Construction Co., Inc.; Flintco, LLC; Generocity Services Inc.; H B Neild & Sons, Inc.; Domingo V. Lopez, III dba JL Squared Construction; Quad-Tex Construction, Inc; SDB, Inc.; Sterling Structures, Inc.; The Pounds Group, LLC dba Sullivan Contracting Services; Texas General Contractors, Inc.; and The Trevino Group, Inc.



**Harris County Department of Education  
Choice Partners  
Instructions to Recommendation Committee**

**[This form is used to document due diligence by Recommendation Committee]**

---

**To:** Recommendation Committee  
**From Choice Partners - Contract Manager:** Joann Nichols  
**Job (Bid or CSP) # and Name:** 21/039MR Addendum 1  
Job Order Contracting (IDIQ)  
**Board Meeting Date:** 7/21/2021  
**Today's Date:** 6/8/2021

Attached are the following materials for your review and possible recommendation to the Superintendent and the Board of Trustees:

Buyer Certification  
Bid Tabulation  
Copy of the Job (Bid or CSP) responses  
Set of Specs will be available for your review

Your responsibility for review of this job (bid or CSP) is to make sure that HCDE receives the best value for the goods and services sought. Please review the attached job (bid or CSP) and certify that all of the procurement requirements have been met in accordance with local Board Policies and legal (federal and state) policies and administrative guidelines set by the Business Office and the Purchasing Division.

Please remember to adhere to section 44.032 of the Texas Education Code, "Enforcement of Purchase Procedures: Criminal Penalties; Removal; Ineligibility" which deal with the penalties related to component, separate, and sequential purchases. In addition, Board policy CH Local and Legal are required to be met as part of your contractual obligation with HCDE.

It should be noted that if a required document is not provided by the bidder, the Purchasing Division will not be able to make a recommendation and or issue a purchase order.

Please review the responses to the job (bid or CSP) and submit the following forms by the required deadline for the next available Board Meeting:

**Signed Certification and Recommendation Form**

If any technicalities or changes need to be made, these must be addressed in the recommendation and presented as such to the Superintendent and the Board of Trustees.

**Agenda Item (Prepared by Buyer handling the job/bid or CSP)**

Once, a recommendation is approved by the Board, the Purchasing Division will issue an award letter and request that any pending bonds or contracts be submitted within 5 days to the District.



Harris County Department of Education  
Choice Partners  
Effectiveness and Compliance Review Form

**[This form is used to document due diligence by Recommendation Committee]**

---

To: Purchasing Audit File and Jesus J. Amezcua,  
CPA, Assistant Supt. for Business  
From Contract Manager: Joann Nichols  
Purchasing Dept: Kendra Jackson, Director  
Job- Bid or CSP# and Name: 21/039MR Addendum 1  
Job Order Contracting (IDIQ)  
Board Meeting Date: 7/21/2021  
Date: 6/8/2021

**Procurement Requirements Available:**

Check One

- Under \$2,500 (Requires Division Director and Asst Supt. Approval)
- From \$2,500 to \$50,000 (Requires Buyer, Purchasing Director/CFO Approval)
- Over \$50,000 (per CH Local)
- Cooperative Programs (Requires Board Approval)

I certify that I have reviewed the attached job (bid or CSP) and certify that all of my actions as a Recommendations Committee Member are within the procurement requirements in accordance with Local Board Policies (CH Local/Legal) and Legal (Federal and State) policies and administrative guidelines set by the Business Office and the Purchasing Division.

I certify that I have adhered to the Purchasing Policies of HCDE concerning the review of this job (bid or RFP) to include policies on conflict of interest.

I certify that I am aware of all purchasing policies (CH Local and CH Legal) and administrative procedures of HCDE.

I certify that I am aware of the penalties of not following the purchasing policies and procedures and in specific with section 44.032 of the Texas Education Code which deals with the penalties related to sequential or component purchases. I further certify that I recommend the issuance of a purchase order after Board approval and execution of a contract.

**(Note: This form is required of all jobs (bids and CSPs) prepared by all buyers and Director)**

21/039MR Addendum 1

Job Order Contracting (IDIQ)

		Aggieland Construction	ASA Builders, Inc	AZTECA Designs, Inc.	Basic SDV, Inc.
<b>Evaluation Criteria</b>	<b>Total Weighted Value</b>				
<b>Averages</b>					
(1) Price Vendor's proposed coefficient(s)	40	35.00	NR	NR	NR
References for local governmental entities and with a purchasing cooperative program Local government agencies within the past 5 years Other projects completed within the past 10 years	15	10.67	NR	NR	NR
(3) Quality of Vendor's products/services and extent to which the products/services meet HCDE and HCDE members' needs: JOC Project Management JOC Infrastructure Solutions Quality of Vendor's Products/Service Demonstrated Ability to Perform Vendor's proposed personnel	25	20.00	NR	NR	NR
(4) Impact on the ability of HCDE members to comply with laws and rules relating to HUB/MWBE/SBE/PDBE/DBE	0	0.00	NR	NR	NR
(5) Vendor's safety record, including current OSHA safety report	5	2.33	NR	NR	NR
(6) Whether Vendor's financial capability is appropriate to the size and scope of the project and the total long-term cost to HCDE and HCDE members to acquire the products/service	5	3.00	NR	NR	NR
(7) For a contract for goods and services, other than goods and services related to telecommunications and information services, building construction and maintenance, or instructional materials, whether the Vendor or the Vendor's ultimate parent company or majority owner: (A) has its principal place of business in this state; or (B) employs at least 500 persons in this state	0	0.00	NR	NR	NR
(8) Vendor's past relationship with HCDE/CP and/or CP members, including Vendor's job order contracting relationship with HCDE/CP and/or CP members	5	3.67	NR	NR	NR
(9) Marketing Plan	5	3.67	NR	NR	NR
<b>Evaluators: Total</b>	<b>100</b>	<b>78.33</b>	<b>0.00</b>	<b>0.00</b>	<b>0.00</b>
Stephen Kendrick Choice Partners		Invitations sent to	1095	prospective bidders	
Mary Causey Choice Partners		Contracts are in accordance with TEC 44.031			
Monique Joseph Choice Partners		It is recommended that the following awards of annual contracts:			
<b>Non-Responsive</b>	<b>14</b>	<u>Contract</u>		<u>Vendor</u>	
<b>Non-Awarded</b>	<b>13</b>	21/039MR -01		Aggieland Construction Ltd	
<b>Award Threshold of 70</b>	<b>16</b>	21/039MR -02		Blue Ox Construction, Inc	
<b>Total Responses</b>	<b>43</b>	21/039MR -03		Brown and Root Industrial Services, LLC	
		21/039MR -04		Corestone Construction Services	
		21/039MR -05		Facilities Sources	
		21/039MR -06		Falkenberg Construction Co., Inc.	

21/039MR Addendum 1

Job Order Contracting (IDIQ)

		Blue Ox Construction, Inc	Brazos - Valley Division, LLC.	Brown and Root Industrial Services, LLC	Cantex Roofing & Construction
<b>Evaluation Criteria</b>					
<b>Averages</b>					
(1) Price Vendor's proposed coefficient(s)	40	29.00	NR	39.00	NR
References for local governmental entities and with a purchasing cooperative program Local government agencies within the past 5 years Other projects completed within the past 10 years	15	10.33	NR	13.33	NR
(3) Quality of Vendor's products/services and extent to which the products/services meet HCDE and HCDE members' needs: JOC Project Management JOC Infrastructure Solutions Quality of Vendor's Products/Service Demonstrated Ability to Perform Vendor's proposed personnel	25	22.67	NR	20.67	NR
(4) Impact on the ability of HCDE members to comply with laws and rules relating to HUB/MWBE/SBE/PDBE/DBE	0	0.00	NR	0.00	NR
(5) Vendor's safety record, including current OSHA safety report	5	5.00	NR	4.00	NR
(6) Whether Vendor's financial capability is appropriate to the size and scope of the project and the total long-term cost to HCDE and HCDE members to acquire the products/service	5	2.00	NR	4.67	NR
(7) For a contract for goods and services, other than goods and services related to telecommunications and information services, building construction and maintenance, or instructional materials, whether the Vendor or the Vendor's ultimate parent company or majority owner: (A) has its principal place of business in this state; or (B) employs at least 500 persons in this state	0	0.00	NR	0.00	NR
(8) Vendor's past relationship with HCDE/CP and/or CP members, including Vendor's job order contracting relationship with HCDE/CP and/or CP members	5	3.33	NR	3.33	NR
(9) Marketing Plan	5	5.00	NR	4.00	NR
<b>Evaluators:</b>	<b>Total</b>	<b>100</b>	<b>0.00</b>	<b>89.00</b>	<b>0.00</b>
Stephen Kendrick Choice Partners			Invitations sent to		1095 prospective bidders
Mary Causey Choice Partners			Contracts are in accordance with TEC 44.031		
Monique Joseph Choice Partners			It is recommended that the following awards of annual contracts:		
<b>Non-Responsive</b>	<b>14</b>			<u>Contract</u>	<u>Vendor</u>
<b>Non-Awarded</b>	<b>13</b>			21/039MR -07	Flintco, LLC
<b>Award Threshold of 70</b>	<b>16</b>			21/039MR -08	Generocity Services, Inc.
<b>Total Responses</b>	<b>43</b>			21/039MR -09	HB Neild & Sons, Inc.
				21/039MR -10	JL Squared Construction
				21/039MR -11	Quad-Tex Construction, Inc
				21/039MR -12	SDB, Inc

21/039MR Addendum 1

Job Order Contracting (IDIQ)

Evaluation Criteria	Total Weighted Value	CMST, LLC (Construction Managers of Southeast Texas, LLC)	Consolidated Services of North America (Ximena Ramirez)	CORESTONE CONSTRUCTION SERVICES (RMB MANAGEMENT)	D7 Roofing & Metal LLC
<b>Averages</b>					
(1) Price Vendor's proposed coefficient(s)	40	30.00	NR	29.00	NR
References for local governmental entities and with a purchasing cooperative program Local government agencies within the past 5 years Other projects completed within the past 10 years	15	5.67	NR	13.67	NR
(3) Quality of Vendor's products/services and extent to which the products/services meet HCDE and HCDE members' needs: JOC Project Management JOC Infrastructure Solutions Quality of Vendor's Products/Service Demonstrated Ability to Perform Vendor's proposed personnel	25	13.33	NR	22.33	NR
(4) Impact on the ability of HCDE members to comply with laws and rules relating to HUB/MWBE/SBE/PDBE/DBE	0	0.00	NR	0.00	NR
(5) Vendor's safety record, including current OSHA safety report	5	2.00	NR	3.67	NR
(6) Whether Vendor's financial capability is appropriate to the size and scope of the project and the total long-term cost to HCDE and HCDE members to acquire the products/service	5	3.00	NR	3.00	NR
(7) For a contract for goods and services, other than goods and services related to telecommunications and information services, building construction and maintenance, or instructional materials, whether the Vendor or the Vendor's ultimate parent company or majority owner: (A) has its principal place of business in this state; or (B) employs at least 500 persons in this state	0	0.00	NR	0.00	NR
(8) Vendor's past relationship with HCDE/CP and/or CP members, including Vendor's job order contracting relationship with HCDE/CP and/or CP members	5	0.33	NR	3.33	NR
(9) Marketing Plan	5	3.00	NR	4.00	NR
<b>Evaluators: Total</b>	<b>100</b>	<b>57.33</b>	<b>0.00</b>	<b>79.00</b>	<b>0.00</b>
Stephen Kendrick Choice Partners		Invitations sent to 1095 Contracts are in accordance with TEC 44.031 It is recommended that the following awards of annual <u>Contract</u> 21/039 -13 21/039 -14 21/039 -15 21/039 -16	prospective bidders Contracts are in accordance with TEC 44.031 It is recommended that the following awards of annual contracts: <u>Vendor</u> Sterling Structures, Inc. Sullivan Contracting Services Texas General Contractors, Inc. The Trevino Group, Inc.		
Mary Causey Choice Partners					
Monique Joseph Choice Partners					
<b>Non-Responsive</b>	<b>14</b>				
<b>Non-Awarded</b>	<b>13</b>				
<b>Award Threshold of 70</b>	<b>16</b>				
<b>Total Responses</b>	<b>43</b>				



21/039MR Addendum 1

Job Order Contracting (IDIQ)

Evaluation Criteria	Total Weighted Value	Dalton Air Conditioning and Heating (Dalton Air Conditioning and Heating, LLC)	EcoXstream, LLC	Ema Sport Solutions (Jhon Mario Madrigal)	Facilities Sources (Dura Pier Facilities Services Ltd.)
<b>Averages</b>					
(1) Price Vendor's proposed coefficient(s)	40	NR	24.00	23.00	20.00
References for local governmental entities and with a purchasing cooperative program Local government agencies within the past 5 years Other projects completed within the past 10 years	15	NR	12.67	9.33	13.00
(3) Quality of Vendor's products/services and extent to which the products/services meet HCDE and HCDE members' needs: JOC Project Management JOC Infrastructure Solutions Quality of Vendor's Products/Service Demonstrated Ability to Perform Vendor's proposed personnel	25	NR	18.33	16.00	22.67
(4) Impact on the ability of HCDE members to comply with laws and rules relating to HUB/MWBE/SBE/PDBE/DBE	0	NR	0.00	0.00	0.00
(5) Vendor's safety record, including current OSHA safety report	5	NR	2.00	1.33	3.67
(6) Whether Vendor's financial capability is appropriate to the size and scope of the project and the total long-term cost to HCDE and HCDE members to acquire the products/service	5	NR	2.00	2.00	4.00
(7) For a contract for goods and services, other than goods and services related to telecommunications and information services, building construction and maintenance, or instructional materials, whether the Vendor or the Vendor's ultimate parent company or majority owner: (A) has its principal place of business in this state; or (B) employs at least 500 persons in this state	0	NR	0.00	0.00	0.00
(8) Vendor's past relationship with HCDE/CP and/or CP members, including Vendor's job order contracting relationship with HCDE/CP and/or CP members	5	NR	4.67	2.67	4.00
(9) Marketing Plan	5	NR	2.67	3.33	5.00
<b>Evaluators: Total</b>	<b>100</b>	<b>0.00</b>	<b>66.33</b>	<b>57.67</b>	<b>72.33</b>
Stephen Kendrick Choice Partners					
Mary Causey Choice Partners					
Monique Joseph Choice Partners					
<b>Non-Responsive</b>	<b>14</b>				
<b>Non-Awarded</b>	<b>13</b>				
<b>Award Threshold of 70</b>	<b>16</b>				
<b>Total Responses</b>	<b>43</b>				

21/039MR Addendum 1

Job Order Contracting (IDIQ)

Evaluation Criteria	Total Weighted Value	Falkenberg Construction Company, Inc.	Flintco, LLC	FMG Construction Group, LLC	Generocity Services Inc.
<b>Averages</b>					
(1) Price Vendor's proposed coefficient(s)	40	21.00	24.00	32.00	30.00
References for local governmental entities and with a purchasing cooperative program Local government agencies within the past 5 years Other projects completed within the past 10 years	15	12.33	13.00	7.00	12.00
(3) Quality of Vendor's products/services and extent to which the products/services meet HCDE and HCDE members' needs: JOC Project Management JOC Infrastructure Solutions Quality of Vendor's Products/Service Demonstrated Ability to Perform Vendor's proposed personnel	25	21.67	19.33	17.67	18.67
(4) Impact on the ability of HCDE members to comply with laws and rules relating to HUB/MWBE/SBE/PDBE/DBE	0	0.00	0.00	0.00	0.00
(5) Vendor's safety record, including current OSHA safety report	5	2.33	4.67	2.00	3.67
(6) Whether Vendor's financial capability is appropriate to the size and scope of the project and the total long-term cost to HCDE and HCDE members to acquire the products/service	5	3.67	5.00	3.33	3.33
(7) For a contract for goods and services, other than goods and services related to telecommunications and information services, building construction and maintenance, or instructional materials, whether the Vendor or the Vendor's ultimate parent company or majority owner: (A) has its principal place of business in this state; or (B) employs at least 500 persons in this state	0	0.00	0.00	0.00	0.00
(8) Vendor's past relationship with HCDE/CP and/or CP members, including Vendor's job order contracting relationship with HCDE/CP and/or CP members	5	4.67	4.00	3.00	3.33
(9) Marketing Plan	5	4.33	4.67	3.33	4.33
<b>Evaluators: Total</b>	<b>100</b>	<b>70.00</b>	<b>74.67</b>	<b>68.33</b>	<b>75.33</b>
Stephen Kendrick Choice Partners					
Mary Causey Choice Partners					
Monique Joseph Choice Partners					
<b>Non-Responsive</b>	<b>14</b>				
<b>Non-Awarded</b>	<b>13</b>				
<b>Award Threshold of 70</b>	<b>16</b>				
<b>Total Responses</b>	<b>43</b>				

21/039MR Addendum 1

Job Order Contracting (IDIQ)

Evaluation Criteria	Total Weighted Value	Gutier Roofing & Sheet Metal (Gutier LLC)	H.B. Neild & Sons, Inc.	ICON Diversified, LLC	J.L. Squared Construction
<b>Averages</b>					
(1) Price Vendor's proposed coefficient(s)	40	NR	31.00	23.00	40.00
References for local governmental entities and with a purchasing cooperative program Local government agencies within the past 5 years Other projects completed within the past 10 years	15	NR	12.33	13.33	11.67
(3) Quality of Vendor's products/services and extent to which the products/services meet HCDE and HCDE members' needs: JOC Project Management JOC Infrastructure Solutions Quality of Vendor's Products/Service Demonstrated Ability to Perform Vendor's proposed personnel	25	NR	20.67	20.67	19.67
(4) Impact on the ability of HCDE members to comply with laws and rules relating to HUB/MWBE/SBE/PDBE/DBE	0	NR	0.00	0.00	0.00
(5) Vendor's safety record, including current OSHA safety report	5	NR	2.00	1.67	2.67
(6) Whether Vendor's financial capability is appropriate to the size and scope of the project and the total long-term cost to HCDE and HCDE members to acquire the products/service	5	NR	4.00	1.67	2.33
(7) For a contract for goods and services, other than goods and services related to telecommunications and information services, building construction and maintenance, or instructional materials, whether the Vendor or the Vendor's ultimate parent company or majority owner: (A) has its principal place of business in this state; or (B) employs at least 500 persons in this state	0	NR	0.00	0.00	0.00
(8) Vendor's past relationship with HCDE/CP and/or CP members, including Vendor's job order contracting relationship with HCDE/CP and/or CP members	5	NR	3.67	2.33	3.67
(9) Marketing Plan	5	NR	3.33	3.00	2.00
<b>Evaluators: Total</b>	<b>100</b>	<b>0.00</b>	<b>77.00</b>	<b>65.67</b>	<b>82.00</b>
Stephen Kendrick Choice Partners					
Mary Causey Choice Partners					
Monique Joseph Choice Partners					
<b>Non-Responsive</b>	<b>14</b>				
<b>Non-Awarded</b>	<b>13</b>				
<b>Award Threshold of 70</b>	<b>16</b>				
<b>Total Responses</b>	<b>43</b>				

21/039MR Addendum 1

Job Order Contracting (IDIQ)

Evaluation Criteria	Total Weighted Value	Kaiser International, Inc	LMC Corp (Lee Construction and Maintenance)	METCO Engineering, Inc.	Mid-Continental Restoration Company, Inc.
<b>Averages</b>					
(1) Price Vendor's proposed coefficient(s)	40	NR	20.00	34.00	24.00
References for local governmental entities and with a purchasing cooperative program Local government agencies within the past 5 years Other projects completed within the past 10 years	15	NR	12.67	7.67	14.00
(3) Quality of Vendor's products/services and extent to which the products/services meet HCDE and HCDE members' needs: JOC Project Management JOC Infrastructure Solutions Quality of Vendor's Products/Service Demonstrated Ability to Perform Vendor's proposed personnel	25	NR	22.33	13.00	16.67
(4) Impact on the ability of HCDE members to comply with laws and rules relating to HUB/MWBE/SBE/PDBE/DBE	0	NR	0.00	0.00	0.00
(5) Vendor's safety record, including current OSHA safety report	5	NR	2.00	2.00	1.67
(6) Whether Vendor's financial capability is appropriate to the size and scope of the project and the total long-term cost to HCDE and HCDE members to acquire the products/service	5	NR	4.00	3.00	3.67
(7) For a contract for goods and services, other than goods and services related to telecommunications and information services, building construction and maintenance, or instructional materials, whether the Vendor or the Vendor's ultimate parent company or majority owner: (A) has its principal place of business in this state; or (B) employs at least 500 persons in this state	0	NR	0.00	0.00	0.00
(8) Vendor's past relationship with HCDE/CP and/or CP members, including Vendor's job order contracting relationship with HCDE/CP and/or CP members	5	NR	4.33	0.00	5.00
(9) Marketing Plan	5	NR	3.67	3.00	3.67
<b>Evaluators: Total</b>	<b>100</b>	<b>0.00</b>	<b>69.00</b>	<b>62.67</b>	<b>68.67</b>
Stephen Kendrick Choice Partners					
Mary Causey Choice Partners					
Monique Joseph Choice Partners					
<b>Non-Responsive</b>	<b>14</b>				
<b>Non-Awarded</b>	<b>13</b>				
<b>Award Threshold of 70</b>	<b>16</b>				
<b>Total Responses</b>	<b>43</b>				

21/039MR Addendum 1

Job Order Contracting (IDIQ)

Evaluation Criteria	Total Weighted Value	Mitchell Contracting	Native Construction (Native Consolidated Management LLC)	Point Alliance Solutions	Quad-Tex Construction, Inc
<b>Averages</b>					
(1) Price Vendor's proposed coefficient(s)	40	24.00	20.00	30.00	37.00
References for local governmental entities and with a purchasing cooperative program Local government agencies within the past 5 years Other projects completed within the past 10 years	15	12.33	10.00	10.00	13.33
(3) Quality of Vendor's products/services and extent to which the products/services meet HCDE and HCDE members' needs: JOC Project Management JOC Infrastructure Solutions Quality of Vendor's Products/Service Demonstrated Ability to Perform Vendor's proposed personnel	25	18.33	15.67	14.67	23.33
(4) Impact on the ability of HCDE members to comply with laws and rules relating to HUB/MWBE/SBE/PDBE/DBE	0	0.00	0.00	0.00	0.00
(5) Vendor's safety record, including current OSHA safety report	5	1.67	1.67	1.67	5.00
(6) Whether Vendor's financial capability is appropriate to the size and scope of the project and the total long-term cost to HCDE and HCDE members to acquire the products/service	5	3.00	3.33	3.00	3.33
(7) For a contract for goods and services, other than goods and services related to telecommunications and information services, building construction and maintenance, or instructional materials, whether the Vendor or the Vendor's ultimate parent company or majority owner: (A) has its principal place of business in this state; or (B) employs at least 500 persons in this state	0	0.00	0.00	0.00	0.00
(8) Vendor's past relationship with HCDE/CP and/or CP members, including Vendor's job order contracting relationship with HCDE/CP and/or CP members	5	3.33	0.00	0.00	4.33
(9) Marketing Plan	5	3.67	4.00	4.33	4.33
<b>Evaluators: Total</b>	<b>100</b>	<b>66.33</b>	<b>54.67</b>	<b>63.67</b>	<b>90.67</b>
Stephen Kendrick Choice Partners					
Mary Causey Choice Partners					
Monique Joseph Choice Partners					
<b>Non-Responsive</b>	<b>14</b>				
<b>Non-Awarded</b>	<b>13</b>				
<b>Award Threshold of 70</b>	<b>16</b>				
<b>Total Responses</b>	<b>43</b>				

21/039MR Addendum 1

Job Order Contracting (IDIQ)

Evaluation Criteria	Total Weighted Value	Quasar Data Center	Radius Design Works, LLC	RDI Mechanical	Restoration Services, Inc. (A & E Tech Reps)
<b>Averages</b>					
(1) Price Vendor's proposed coefficient(s)	40	NR	26.00	NR	NR
References for local governmental entities and with a purchasing cooperative program Local government agencies within the past 5 years Other projects completed within the past 10 years	15	NR	13.33	NR	NR
(3) Quality of Vendor's products/services and extent to which the products/services meet HCDE and HCDE members' needs: JOC Project Management JOC Infrastructure Solutions Quality of Vendor's Products/Service Demonstrated Ability to Perform Vendor's proposed personnel	25	NR	16.67	NR	NR
(4) Impact on the ability of HCDE members to comply with laws and rules relating to HUB/MWBE/SBE/PDBE/DBE	0	NR	0.00	NR	NR
(5) Vendor's safety record, including current OSHA safety report	5	NR	1.67	NR	NR
(6) Whether Vendor's financial capability is appropriate to the size and scope of the project and the total long-term cost to HCDE and HCDE members to acquire the products/service	5	NR	2.00	NR	NR
(7) For a contract for goods and services, other than goods and services related to telecommunications and information services, building construction and maintenance, or instructional materials, whether the Vendor or the Vendor's ultimate parent company or majority owner: (A) has its principal place of business in this state; or (B) employs at least 500 persons in this state	0	NR	0.00	NR	NR
(8) Vendor's past relationship with HCDE/CP and/or CP members, including Vendor's job order contracting relationship with HCDE/CP and/or CP members	5	NR	3.00	NR	NR
(9) Marketing Plan	5	NR	4.33	NR	NR
<b>Evaluators: Total</b>	<b>100</b>	<b>0.00</b>	<b>67.00</b>	<b>0.00</b>	<b>0.00</b>
Stephen Kendrick Choice Partners					
Mary Causey Choice Partners					
Monique Joseph Choice Partners					
<b>Non-Responsive</b>	<b>14</b>				
<b>Non-Awarded</b>	<b>13</b>				
<b>Award Threshold of 70</b>	<b>16</b>				
<b>Total Responses</b>	<b>43</b>				

21/039MR Addendum 1

Job Order Contracting (IDIQ)

Evaluation Criteria	Total Weighted Value	SDB Contracting Services (SDB, Inc)	Sterling Structures, Inc.	Sullivan Contracting Services (Pounds Group, LLC)	Texas General Contractors, Inc.
<b>Averages</b>					
(1) Price Vendor's proposed coefficient(s)	40	32.00	39.00	34.00	30.00
References for local governmental entities and with a purchasing cooperative program Local government agencies within the past 5 years Other projects completed within the past 10 years	15	13.33	15.00	11.33	13.33
(3) Quality of Vendor's products/services and extent to which the products/services meet HCDE and HCDE members' needs: JOC Project Management JOC Infrastructure Solutions Quality of Vendor's Products/Service Demonstrated Ability to Perform Vendor's proposed personnel	25	23.33	20.00	21.33	21.00
(4) Impact on the ability of HCDE members to comply with laws and rules relating to HUB/MWBE/SBE/PDBE/DBE	0	0.00	0.00	0.00	0.00
(5) Vendor's safety record, including current OSHA safety report	5	5.00	4.67	3.00	3.00
(6) Whether Vendor's financial capability is appropriate to the size and scope of the project and the total long-term cost to HCDE and HCDE members to acquire the products/service	5	4.67	4.33	3.67	3.00
(7) For a contract for goods and services, other than goods and services related to telecommunications and information services, building construction and maintenance, or instructional materials, whether the Vendor or the Vendor's ultimate parent company or majority owner: (A) has its principal place of business in this state; or (B) employs at least 500 persons in this state	0	0.00	0.00	0.00	0.00
(8) Vendor's past relationship with HCDE/CP and/or CP members, including Vendor's job order contracting relationship with HCDE/CP and/or CP members	5	4.33	4.67	4.00	3.67
(9) Marketing Plan	5	4.67	4.33	2.67	3.67
<b>Evaluators: Total</b>	<b>100</b>	<b>87.33</b>	<b>92.00</b>	<b>80.00</b>	<b>77.67</b>
Stephen Kendrick Choice Partners					
Mary Causey Choice Partners					
Monique Joseph Choice Partners					
<b>Non-Responsive</b>	<b>14</b>				
<b>Non-Awarded</b>	<b>13</b>				
<b>Award Threshold of 70</b>	<b>16</b>				
<b>Total Responses</b>	<b>43</b>				

21/039MR Addendum 1

Job Order Contracting (IDIQ)

Evaluation Criteria	Total Weighted Value	The Trevino Group, Inc.	Weatherproofing Services (Weatherproofing Service LLC)	Wylie Construction Services
<b>Averages</b>				
(1) Price Vendor's proposed coefficient(s)	40	34.00	NR	22.00
References for local governmental entities and with a purchasing cooperative program Local government agencies within the past 5 years Other projects completed within the past 10 years	15	13.33	NR	9.00
(3) Quality of Vendor's products/services and extent to which the products/services meet HCDE and HCDE members' needs: JOC Project Management JOC Infrastructure Solutions Quality of Vendor's Products/Service Demonstrated Ability to Perform Vendor's proposed personnel	25	18.33	NR	15.00
(4) Impact on the ability of HCDE members to comply with laws and rules relating to HUB/MWBE/SBE/PDBE/DBE	0	0.00	NR	0.00
(5) Vendor's safety record, including current OSHA safety report	5	2.00	NR	2.00
(6) Whether Vendor's financial capability is appropriate to the size and scope of the project and the total long-term cost to HCDE and HCDE members to acquire the products/service	5	4.00	NR	3.00
(7) For a contract for goods and services, other than goods and services related to telecommunications and information services, building construction and maintenance, or instructional materials, whether the Vendor or the Vendor's ultimate parent company or majority owner: (A) has its principal place of business in this state; or (B) employs at least 500 persons in this state	0	0.00	NR	0.00
(8) Vendor's past relationship with HCDE/CP and/or CP members, including Vendor's job order contracting relationship with HCDE/CP and/or CP members	5	1.33	NR	2.33
(9) Marketing Plan	5	2.33	NR	1.33
<b>Evaluators: Total</b>	<b>100</b>	<b>75.33</b>	<b>0.00</b>	<b>54.67</b>
Stephen Kendrick Choice Partners				
Mary Causey Choice Partners				
Monique Joseph Choice Partners				
<b>Non-Responsive</b>	<b>14</b>			
<b>Non-Awarded</b>	<b>13</b>			
<b>Award Threshold of 70</b>	<b>16</b>			
<b>Total Responses</b>	<b>43</b>			



# Harris County Department of Education

## Participation Detail as of 6/24/2021 09:24:47 AM (CT)

### Bid Information

Bid Creator Joann Nichols Choice Partners Asst. Director  
 Email jnichols@hcde-texas.org  
 Phone (713) 696-2122  
 Fax (713) 696-0731  
  
 Bid Number 21/039MR Addendum 1  
 Title CSP for JOC - IDIQ Construction  
 Bid Type Competitively Sealed Proposal  
 Issue Date 3/12/2021 03:28 PM (CT)  
 Close Date 5/7/2021 02:00:00 PM (CT)

### Participation Summary

Company Name	City, State	Invitation Date	Status	Status Date	Response Date
048BRI (Dragon Limited Inc)	Metairie, LA	03/12/2021			
1st Materials Soil Stabilization (1st Materials & Technology, Inc.)	cameron, TX	03/12/2021			
210 Backflow	Universal City, TX		Viewed	05/01/2021	
2K Design Services, LLC	Spring, TX	03/12/2021			
3 Concepts Contractors (Gillespie Capital Enterprises LLC)	Corpus Christi, TX	03/12/2021			
308 Construction, LLC	Argyle, TX	03/12/2021			
360TXC, LLC	Austin, TX	03/12/2021			
365 Paving & Construction LLC	Mission, TX	03/12/2021			
3i Contracting LLC	Houston, TX	03/12/2021			
A & H Electric	Conroe, TX	03/12/2021			
a & i custom manufacturing llc	brownsville, TX	03/12/2021			
A Clearer Image	YORKTOWN, VA	03/12/2021			
A Light Construction	Dallas, TX	03/12/2021			
A Status Construction LLC	Houston, TX	03/12/2021			
A&E Development	Houston, TX		Viewed	04/27/2021	
A&L Sanchez Painting and Construction	Killeen, TX	03/12/2021			
A. Bargas & Associates, LLC	San Antonio, TX	03/12/2021			
A.G.H. Environmental, Inc.	Houston, TX	03/12/2021			
A.T. Kearney	Chicago, IL	03/12/2021			
AA Distribution inc	Newark, NJ	03/12/2021			
AAA Painting	Houston, TX	03/12/2021			
AAA Time Saver Services	San Antonio, TX	03/12/2021			
AB Modern Houston LLC	Houston, TX	03/12/2021			
ABBA Construction	Webster, TX	03/12/2021			
ABM Education	Houston, TX	03/12/2021			
ABM Underground Utility Const Company	Magnolia, TX	03/12/2021			
ABS MULTI SERVICES (ABS JANITORIAL SERVICE, LLC)	DALLAS, TX	03/12/2021			
Absolute Waterproofing	Kerrville, TX	03/12/2021			
AC/DC Synergy Group	Tomball, TX	03/12/2021	Viewed	04/28/2021	
ACE FABRICATORS INC	Houston, TX	03/12/2021			
Acme Architectural Hardware	Houston, TX	03/12/2021			
Acme Fence Services Inc	Haltom City, TX	03/12/2021			
ACTION RESTORATION, INC.	PORT ARTHUR, TX	03/12/2021			
Acumen Enterprises, Inc.	Desoto, TX	03/12/2021			
Adept Facilities & Design, Inc.	Harlingen, TX	03/12/2021			
ADG General Contractor & Construction (Affiliated Development Group LLC)	Richardson, AL	03/12/2021			
Advancetech Systems (Advancetech Systems 2, Inc.)	Houston, TX	03/12/2021			
AdvantaClean of San Antonio	San Antonio, TX	03/12/2021			
Adventure Experiences, LLC	Trinity, TX	03/12/2021			
Advocate Solutions	Humble, TX	03/12/2021			

AECOM (AECOM Technical Services Inc)	Houston, TX	03/12/2021			
Aerodynamics Inspecting of Texas, LLC	San Juan, TX	03/12/2021			
AFD Services LLC	Cypress, TX	03/12/2021			
Aggeland Construction	Wellborn, TX	03/12/2021	Submitted	03/29/2021	03/29/2021
Aggreko	Pearland, TX	03/12/2021			
AGH2O Holdings, LLC	Round Rock, TX	03/12/2021			
Agile Environmental, LLC	Houston, TX	03/12/2021	Viewed	04/28/2021	
Airwall Techs, LLC	Pasadena, TX	03/12/2021			
Alabama	Montgomery, AL	03/12/2021			
Alegna Technologies, Inc.	Kennesaw, GA	03/12/2021	Unsubmitted	05/08/2021	
Alklean Industries, Inc	Pasadena, TX		Viewed	05/06/2021	
ALL AMERICAN SPECIALTY CONSTRUCTION LLC	IRVING, TX	03/12/2021			
All Around Construction Company, LLC	Andrews, TX	03/12/2021			
All Clean Services	Grand Prairie, TX	03/12/2021			
All Doors and More	Sinton, TX	03/12/2021			
All Kinds Of Doors (Iyoob)	Houston, TX	03/12/2021			
All Pro Commercial Services (APC Industries, LLC)	RICHLAND HILLS, TX	03/12/2021			
All Texas Electrical Contractors Inc.	Houston, TX	03/12/2021			
All-Fair Electric, Inc	Fort Worth, TX	03/12/2021			
Alliance Tank Service (ATS Group, LLC)	Cushing, OK	03/12/2021			
Allied electric Services Inc.	Georgetown, TX	03/12/2021			
Allied Signs	Houston, TX	03/12/2021			
All-Terra Engineering, Inc (All-Terra Materials Testing, Inc)	Houston, TX	03/12/2021			
Ally Roofing Services	Houston, TX	03/12/2021			
Alpha Building Corporation	San Antonio, TX	03/12/2021			
Alpine Construction Company (Alpine Engineering & Construction, LLC)	Houston, TX	03/12/2021			
Al-Raza Computing Services (Al-Razaq Computing Services)	Houston, TX, TX	03/12/2021			
Altius Graphics (NAYAK Corporation)	Houston, TX	03/12/2021			
Alvin Equipment Company	Alvin, TX	03/12/2021			
Alviso's Flash Cleaning	Irving, TX	03/12/2021			
Ameresco, Inc.	Dallas, TX	03/12/2021			
American Container Homes	El Paso, TX	03/12/2021			
American Flag Pole	Abingdon, VA	03/12/2021			
AMERICAN FLOORING SERVICES	Richmond, TX	03/12/2021			
AMERICAN HVAC SERVICES, LLC	HOCKLEY, TX	03/12/2021			
American Restoration LLC	Wylie, TX	03/12/2021			
American Roofing & Metal Co., Inc.	San Antonio, TX	03/12/2021			
American Technologies, Inc	Plano, TX	03/12/2021			
Amstar, Inc.	San Antonio, TX	03/12/2021	Viewed	05/07/2021	
Andrew's Janitorial Service, Inc.	Manteca, CA	03/12/2021			
Aogo Tech Services	Richmond, TX	03/12/2021			
Apache Services, Inc.	Pasadena, TX	03/12/2021			
APEX Consulting group	Houston, TX	03/12/2021			
Aphid Maintenance Group	Crosby, TX	03/12/2021			
Aqua One LLC	Nederland, TX	04/05/2021			
AR Mechanical, L.L.C.	South Houston, TX	03/12/2021			
AR Turnkey Construction Company (Adam Turner)	Houston, TX	03/12/2021			
Aramark Management Services Limited Partnership (Aramark SMMS LLC)	Philadelphia, PA	03/12/2021			
ARC Abatement, Inc.	Waco, TX	03/12/2021			
Architectural Sales Inc	The Woodlands, TX	03/12/2021			
ardurra group	houston, TX	03/12/2021			
ARG Capital LLC	Houston, TX	03/12/2021			
Aries Building Systems LLC	Houston, TX	03/12/2021			
ARMKO Industries Inc	Flower Mound, TX	03/12/2021			
Armor Construction	El Paso, TX	03/12/2021			
Arrow Exterminators	Houston, TX	03/12/2021			
ASA Builders, Inc	pasadena, TX	03/12/2021	Submitted	05/04/2021	05/04/2021
ASAP Roofing (Koppel & Kozel, LLC)	Tyler, TX	03/12/2021			
Ascension Roofing and Construction, LLC	Houston, TX	03/12/2021			
ASD Consultants, Inc.	Austin, TX	03/12/2021			

ASG Energy, LLC	San Antonio, TX	03/12/2021			
Associated Testing Laboratories, inc,	houston, TX	03/12/2021			
Atkins Powerhouse Consulting LLC	Fort Worth, TX	03/12/2021			
Atlas Efficiency Solutions, LLC	Austin, TX	03/12/2021			
Atlas Foundation Repair (Atlas Gulf Coast)	Houston, TX	03/12/2021			
Atrium Roofing	San Antonio, TX	03/12/2021			
ATViroTech Inc.	Missouri City, TX	03/12/2021			
ATW MGMT INC	Houston, TX	03/12/2021			
AtWork Personnal Srvices (Aceda Solutions)	Houston, TX	03/12/2021			
ATX Fence Supply	Buda, TX	03/12/2021			
Automated Energy Solutions (Troy Geyer)	West Lake Hills, TX	03/12/2021			
Aztec Facility Services, Inc.	Houston, TX	03/12/2021			
AZTECA Designs, Inc.	Somerset, TX	03/12/2021	Submitted	05/07/2021	05/07/2021
B & C CONSTRUCTORS, LP	Magnolia, TX	03/12/2021			
B. D. & W. Const.	Houston, TX	03/12/2021			
Bakers Signs and Lighting	Conroe, TX	03/12/2021			
Baldwin Cleaning Services	Waldorf, MD	03/12/2021			
Barnett AC Home Repair And Commercial Services LLC	Katy, TX	03/12/2021			
Barstone, Inc.	San Antonio, TX	03/12/2021			
BaseLine Paving & Construction, Inc.	Magnolia, TX	03/12/2021			
Basic IDIQ	Houston, TX	03/12/2021	Unsubmitted	03/18/2021	
Basic SDV, Inc.	Austin, TX	03/12/2021	Submitted	05/07/2021	05/07/2021
Bass Constuction Co., Inc.	Rosenberg, TX	03/12/2021			
Bath Fitter	San Antonio, TN	03/12/2021			
Batterson, LLP	Houston, TX	03/12/2021			
Battleground WTS	Houston, TX	03/12/2021			
Bauer Sport Floors, Inc.	Houston, TX	03/12/2021			
BAXTER CLEANCARE (John M. Baxter Sales Co.)	Longview, TX	03/12/2021			
Baywood Exterminating Co	Crosby, TX	03/12/2021			
BC Commercial (Beach Construction, Inc.)	Houston, TX	03/12/2021			
BCS A-1 Professional Cleaning	College Station, TX	03/12/2021			
BD Modular Sales and Leasing	Dallas, TX	03/12/2021			
BDK And Associates LLC	Colleyville, TX	03/12/2021			
BE Staffing Solutions LLC	Houston, TX	03/12/2021			
BE&K Building Group, LLC	Houston, TX	03/12/2021			
BEASLEY TIRE SERVICE, INC	HOUSTON, TX	03/12/2021			
Bedrock International Group, LLC	Houston, TX	03/12/2021			
BEK Co.	Missouri City, TX	03/12/2021			
Belfor Property Restoration (BELFOR USA Group, Inc.)	Waco, TX	03/12/2021			
Belknap Concrete	Houston, TX	03/12/2021			
Belknap Plumbing Systems, Inc.	Houtson, TX	03/12/2021			
BenchMark Facility Solutions, LLC	Dallas, TX	03/12/2021			
Benco Commercial Roofing (Benco Construcion Services Inc)	fort worth, TX	03/12/2021			
Bernhard (Bernhard MCC LLC)	Houston, TX	03/12/2021			
Best Green Cleaning	Houston, TX	03/12/2021			
Big Art Co.	Galveston, TX	03/12/2021			
Big Bear Roofing & Construction	Clifton, TX	03/12/2021			
Blackland Glass & Construction	Greenville, TX	03/12/2021			
Blackmon Mooring of Texas	Haltom City, TX	03/12/2021			
BLS Construction, Inc.	El Campo, TX	03/12/2021			
Blue Heron Construction Services, LLC	Richmond, TX	03/12/2021			
Blue Ox Construction, Inc	Fulshear, TX	03/12/2021	Submitted	04/23/2021	04/23/2021
BluGreen Pest Control	Wallis, TX	03/12/2021			
BMS CONSTRUCTION	DICKINSON, TX	03/12/2021			
Bond Restoration Inc	Houston, TX	03/12/2021			
Boyd's Window Cleaning	Houston, TX	03/12/2021			
Boyer, Inc.	Houston, TX	03/12/2021			
Bradlink LLC	Kingwood, TX	03/12/2021			
Braun & Butler Construction	Cedar Park, TX	03/12/2021			
Brazos - Valley Division, LLC.	Seabrook, TX	03/12/2021	Submitted	03/25/2021	03/25/2021
Brazos Urethane, Inc.	Texas City, TX	03/12/2021			
Brazos Valley Contractors Assoc	BRYAN, TX	03/12/2021			
Brian Duffy and Associates	Irving, TX	03/12/2021			

Briar Patch	Houston, TX	03/12/2021			
BridgeNet Communications, LLC	Donna, TX	03/12/2021			
Bright Side Construction and Pressure Washing	Houston, TX	03/12/2021			
Britain Electric	Houston, TX	03/12/2021			
Broadcast Technical Services, Inc.	Houston, TX	03/12/2021			
Broome Welding & Machine CO., Inc	Galveston, TX	03/12/2021			
Brown and Root Industrial Services, LLC	Houston, TX	03/12/2021	Submitted	05/07/2021	05/07/2021
Brush Effects Inc. (Terry Mallory)	La Marque, TX	03/12/2021			
BryMak & Associates Inc	Clarksville, TN	03/12/2021			
BSA Design Group Inc.	Dallas, TX	03/12/2021			
Building Air Quality (BAQ Incorporated)	The Woodlands, TX	03/12/2021			
Building Solutions	dallas, TX	03/12/2021			
Building Tech Team, LLC	Von Ormy, TX	03/12/2021			
Bunky and Son Construction, LLC	Alvin, TX	03/12/2021			
Business Flooring Partners, LLC	Fort Worth, TX	03/12/2021			
BWI Companies, Inc.	Nash, TX	03/12/2021			
C&B ELECTRIC & A/C SERVICES	McAllen, TX	03/12/2021			
C&L Consulting	Houston, TX	03/12/2021			
C. F. McDonald Electric, Inc.	Houston, TX	03/12/2021			
C1S Group, Inc.	Dallas, TX	03/12/2021			
Cable Construction Company (Joe Tom Cable)	Nocona, TX	03/12/2021			
CAESAR CONSTRUCTION INC	HOUSTON, TX	03/12/2021			
Calico Construction and Development LLC	Mission, TX	03/12/2021			
California	West Sacramento, CA	03/12/2021			
Cantex Roofing & Construction	Idalou, TX	03/12/2021	Submitted	05/04/2021	05/04/2021
Caprock Electric	Houston, TX	03/12/2021	Viewed	04/27/2021	
Carlos Rodriguez	Houston, TX	03/12/2021			
CARPET 911 CLEANING & RESTORATION	DALLAS, TX	03/12/2021			
Castro Roofing of Texas, L.P.	Dallas, TX	03/12/2021			
Cavalry Construction	San Antonio, TX	03/12/2021			
CBRE   Heery (CBRE Heery, Inc.)	Houston, TX	03/12/2021			
CDJ JONES LLC (Cubes Office Services)	Houston, TX	03/12/2021			
CDM Contracting Services	Brownsville, TX	03/12/2021			
CEC Facilities Group	Irving, TX	03/12/2021			
Ceilpro	Lumberton, TX	03/12/2021			
Centennial Contractors Enterprises, Inc.	Houston, LA	03/12/2021			
Centennial Moisture Control, Inc.	Irving, TX	03/12/2021			
Centex Construction	Temple, TX	03/12/2021			
Century Weatherproofing INC	Bowie, TX	03/12/2021			
Cettasale, Inc.	Crowley, TX	03/12/2021			
CFI Mechanical, Inc.	Houston, TX	03/12/2021			
CFW ENTERPRISES LLC	Aurora, CO	03/12/2021			
CGI Texas (Concrete Gel Injections Texas, Inc.)	Garland, TX	03/12/2021			
CHAMPCO, INC.	Bryan, TX	03/12/2021			
CHAMPION AWARDS	Weslaco, TX		No Bid	04/13/2021	04/13/2021
Chase in Dreams, Speech and Drama (Deadra Chase)	Houston, TX	03/12/2021			
Chavez Service Companies, Inc. (.)	Houston, TX	03/12/2021			
Cherry House Moving	Houston, TX	03/12/2021			
Child Care Associates	FORT WORTH, TX	03/12/2021			
Chiron Communicaiton Services, LLC	Humble, TX	03/12/2021	Viewed	04/27/2021	
CiVolt Services, LLC	Hockley, TX	03/12/2021			
Classic Protection Systems, Inc.	Houston, TX	03/12/2021			
Clayton Total Gym	Rusk, TX	03/12/2021			
Clean and Green Solutions (EGR Exterior Services, LLC)	Porter, TX	03/12/2021			
Clean Ayr (Ayr Data, Inc.)	Desoto, TX	03/12/2021			
cleaningessence LLC	HOUSTON, TX	03/12/2021			
CleanNet of Houston	Houston, TX	03/12/2021			
cLI-Energy and Construction LL	Houston, TX	03/12/2021			
Clifford Power Systems, Inc.	Tulsa, OK	03/12/2021			
CMC Construction Services (CMC Steel Fabricators)	Dallas, TX	03/12/2021			
CMC Development & Construction Corporation	Houston, TX	03/12/2021			
LLC					
CMST, LLC (Construction Managers of Southeast Texas, LLC)	Port Arthur, TX	03/12/2021	Submitted	05/07/2021	05/07/2021

Coastal Air Balance Corp.	Metairie, LA	03/12/2021			
Coastal Remediation	Dickinson, TX	03/12/2021			
Coit, Inc. (Coit Services)	Houston, TX	03/12/2021	Viewed	04/28/2021	
COLEXAS DIGITAL INC	Cypress, TX	03/12/2021			
Collaborate PM LLC	Houston, TX	03/12/2021			
Colonial Roofing	Fort Worth, TX	03/12/2021			
Combined Refrigeration Resources, Inc.	Humble, TX	03/12/2021			
Comex Corporation	La Porte, TX	03/12/2021			
Comflow Mechanical Services	Houston, TX	03/12/2021			
Comfort Systems USA - South Central	Houston, TX	03/12/2021			
Commercial Equipment & Sales Co.	Houston, TX	03/12/2021			
Commercial Wallcovering Corp.	Tomball, TX	03/12/2021			
Commercial Wallcovering Corp.	Houston, TX	03/12/2021			
Complete Companies Inc	Salisbury, NH	03/12/2021			
Complete Electrical Services of Texas, Inc.	Seabrook, TX	03/12/2021			
CompuPro Global (Rita's Tape Media)	Houston, TX	03/12/2021			
Concept Facility Services LLC	Duncanville, TX	03/12/2021			
CONCORD COMMERCIAL SERVICES, INC	BALCH SPRINGS, TX	03/12/2021			
ConEdison Solutions (Consolidated Edison, Inc.)	New York, NY	03/12/2021			
Connecticut	Hartford, CT	03/12/2021			
Consolidated Services of North America (Ximena Ramirez)	Houston, TX	03/12/2021	Submitted	05/07/2021	05/07/2021
Constructconnect	cincinnati, GA	03/12/2021	Viewed	04/28/2021	
Construction Bid Source	Felton, CA	03/12/2021			
Construction Diversity Group	Houston, TX	03/12/2021			
Construction EcoServices	Houston, TX		Unsubmitted	05/17/2021	
Construction Journal	Stuart, FL	03/12/2021			
Construction Masters of Houston, Inc	Pearland, TX	03/12/2021			
Continuum Restoration Services, LLC	Lafayette, LA	03/12/2021			
CORE construction services of Texas, Inc.	Frisco, TX	03/12/2021			
CORESTONE CONSTRUCTION SERVICES (RMB MANAGEMENT)	TOMBALL, TX	04/16/2021	Submitted	05/06/2021	05/06/2021
Corporate Care	Houston, TX	03/12/2021	No Bid	03/12/2021	03/22/2021
Corporate Vision Inc	Douglasville, GA	03/12/2021	Viewed	04/28/2021	
Correct Electric Inc	Houston, TX	03/12/2021			
Cosmos Construction, Inc.	Houston, TX	03/12/2021			
Cossey's Services, LLC	The Woodlands, TX	03/12/2021			
Cotton Commercial USA	Katy, TX	03/12/2021			
Council Rock Enterprises, LLC	Rochester, NY	03/12/2021			
Covid Safety Glass (Silent West LLC)	LAS VEGAS, NV	03/12/2021			
Coyote Innovations (Coyote Marketing llc)	HOUSTON, TX	03/12/2021			
CRAFT SAFETY INSPECTIONS (JMAC GROUP LLC)	HOUSTON, TX	03/12/2021			
Crawford Industrial Services, LLC.	Santa Fe, TX	03/12/2021			
CRG Texas Environmental Services	Rosenberg, TX	03/12/2021			
Crimson Vision Enterprises	Dickinson, TX	03/12/2021			
Crosswinds Contracting	Conroe, TX	03/12/2021			
CRT, GC DBA Caprock Construction	Wellborn, TX	03/12/2021			
CRX inc	Houston, TX	03/12/2021			
Crystal Facility Solutions	Houston, TX	03/12/2021			
CS Construction and Development (TRESAN COMPANY)	mission, TX	03/12/2021			
CSJ Group	Edinburg, TX	03/12/2021			
CVAL Innovations (CVAL Innovations LLC)	Irving, TX	03/12/2021			
Cyclone FPV (Cyclone 3D, Inc.)	Spring, TX	03/12/2021			
D & G Quality Roofing Inc.	Burleson, TX	03/12/2021			
D & R Electric Company	San Antonio, TX	03/12/2021			
D.A.N.'s One Stop, LLC.	Shreveport, LA	03/12/2021			
D7 Roofing & Metal LLC	Houston, TX		Submitted	05/07/2021	05/07/2021
DAE & Associates, LTD dba Geotech Engineering and Testing	Houston, TX	03/12/2021			
Daise Management, LLC (Alfred Daise)	Houston, TX	03/12/2021			
Dale Dobbins	houston, TX	03/12/2021			
Dalton Air Conditioning and Heating (Dalton Air Conditioning and Heating, LLC)	Pearland, TX		Submitted	05/05/2021	05/05/2021
Dalworth Lighting and Electrical LLC, (Dalworth Lighting and Electrical)	Forth Worth, TX	03/12/2021			

Dan Loc Group	Houston, TX	03/12/2021			
DANIEL GE CONSTRUCTION INC	San Antonio, TX	03/12/2021			
Danny's Laundry Service	Pasadena, TX	03/12/2021			
David James (David Hebert)	KEMAH, TX	03/12/2021			
DBI Construction Inc, (David Boggs dba DBI Construction)	Cypress, TX	03/12/2021			
DBL Management Solutions	Missouri City, TX	03/12/2021			
DeAngelo Brothers LLC	Hazleton, PA	03/12/2021			
DeArco Inc	Odessa, TX	03/12/2021			
Debbie J. Anders Consulting	Cypress, TX	03/12/2021			
Delaware	Dover, DE	03/12/2021			
Delta T Equipment	Houston, TX	03/12/2021			
DEMS,LLC	Houston, TX	03/12/2021			
Denton and Bradley Metal Solutions, INC	Big Spring, TX	03/12/2021			
DGR United	houston, TX	03/12/2021			
Diamond KK, Inc.	Conroe, TX	03/12/2021			
DIAZ-MEX CONSTRUCTION	Katy, TX	03/12/2021			
DIG Engineers	Houston, TX	03/12/2021			
Digital Air Control, Inc	Houston, TX	03/12/2021	Unsubmitted	05/11/2021	
Dillon Construction & Renovations, LLC	Metairie, LA	03/12/2021			
Ditch Witch of Houston	Houston, TX	03/12/2021			
Diverse Consulting Enterprises, Inc.	HOUSTON, TX	03/12/2021			
Diversified Services LLC (Calvin's Diversified Services LLC)	HOUSTON, TX	03/12/2021			
DivisionOne Construction LLC	Houston, TX	03/12/2021	Viewed	05/04/2021	
DNA Electrical Systems (AMA Quality, LLC)	houston, TX	03/12/2021			
DNB Enterprises, Inc.	Magnolia, TX	03/12/2021			
Dodge Data & Analytics	New York, NY	03/12/2021			
DRC Emergency Services, LLC	Mobile, AL	03/12/2021			
DRC Fort Worth, LLC (DRC Fort Worth LLC)	Fort Worth, TX	03/12/2021	No Bid	05/07/2021	05/07/2021
Dri Right Restoration Services of Texas	San Antonio, TX	03/12/2021			
DrPowerWasher, Inc.	Gun Barrel City, TX	03/12/2021			
Drymalla Construction Company	Columbus, TX	03/12/2021			
Drymore Company	Houston, TX	03/12/2021			
DT Construction, LP	Humble, TX	03/12/2021			
Dunhill Development and Construction	Houston, TX	03/12/2021			
Duro-Last, Inc.	Saginaw, MI	03/12/2021			
Dust trappers llc	BIRDSBORO, PA	03/12/2021			
Du-West Construction, Inc.	Pasadena, TX	03/12/2021			
dycor inc.	pearland, TX	03/12/2021			
E & F Construction enterprises llc	United States, TX	03/12/2021			
E & J Energy Solutions	The Woodlands, TX	03/12/2021			
E Contractors LLC	Sugar Land, TX	03/12/2021	No Bid	04/21/2021	04/26/2021
E&V KITCHEN EXHAUST CLEANING	RIVER OAKS, TX	03/12/2021			
E.R.S., Inc. (Elevator Repair Service, Inc.)	Houston, TX	03/12/2021	No Bid	03/12/2021	03/12/2021
E3 Entegral Solutions, Inc	Highland Village, TX	03/12/2021			
EA Plumbing & Property Services (Evolution Alignment Inc)	Houston, TX	03/12/2021			
Earl P. Forbrich, Jr. Inc	San Antonio, TX	03/12/2021			
ECM International, Inc.	El Paso, TX	03/12/2021			
eco Construction, Inc.	Little Rock, AR	03/12/2021			
ECO Restoration & Cleaning Services (ECO Clean LLC)	League City, TX	03/12/2021			
ecodeclean, llc	HOUSTON, TX	03/12/2021			
EcoXstream, LLC	Hitchcock, TX	03/12/2021	Submitted	05/07/2021	05/07/2021
EDEL Roofing & Construction Inc.	Edinburg, TX	03/12/2021			
Educational Systems Consulting	Binghamton, NY	03/12/2021			
EE&G Construction & Electrical, LLC	Miami Lakes, FL	03/12/2021			
EGC Inc	San Antonio, TX	03/12/2021			
EIKON Consultant Group, LLC	Sanger, TX	03/12/2021			
Electrical Tech Services, Inc.	Houston, TX	03/12/2021			
Elite and Complete Services	Houston, TX	03/12/2021			
Elite One Construction Group	Terrell, TX	03/12/2021			
Elite Pumps & Mechanical Services, LLC	Houston, TX	03/12/2021			
Elite Water and Coffee	Ridgeland, MS	03/12/2021			
E-Logic, Inc.	Washington, DC	03/12/2021	No Bid	04/02/2021	04/02/2021
ElstonAire Inc.	Desoto, TX	03/12/2021			

EM Office Services	Humble, TX	03/12/2021			
Ema Sport Solutions (Jhon Mario Madrigal)	Missouri city, TX		Submitted	05/04/2021	05/04/2021
EMC Resurfacing	San Antonio, TX	03/12/2021			
Emerald Standard Services, Inc.	Pasadena, TX	03/12/2021			
Emian Drywall and Renovating	Mesquite, TX	03/12/2021			
EMJ Corporation	Irving, TX	03/12/2021			
Enigma Electric LLC	Spring, TX	03/12/2021			
Enterprise Builders LLC	Houston, TX	03/12/2021			
Entrust One Facility Services, Inc	Dallas, TX	03/12/2021			
Envirostatic, LLC	Temple, TX	03/12/2021			
Epic Solar Control, LLC	Mckinney, TX	03/12/2021			
Epoxy Design Systems, Inc.	Houston, TX	03/12/2021			
Equipment Management Services	Houston, TX	03/12/2021			
ERC Environmental & Construction Services, Inc.	Houston, TX	03/12/2021			
Evolve Holdings Inc	Houston, TX	03/12/2021	No Bid	04/01/2021	04/01/2021
Excel Medical Waste	Houston, TX	03/12/2021			
Exclusive Windows & Doors (Pursuit Properties, LLC)	Houston, TX	03/12/2021			
Executive Pro High Cleaning Agency	Houston, TX	03/12/2021			
ExerPlay, Inc	Cedar Crest, NM	03/12/2021			
Exterior Creations Inc	Houston, TX	03/12/2021			
Extreme Air Duct Cleaning And Restoration Services	Houston, TX	03/12/2021			
EZ-ACCESS (Homecare Products Inc.)	Algona, WA	03/12/2021			
F.H. Paschen, S.N.Nielsen & Associates LLC	Chicago, IL	03/12/2021	Viewed	04/27/2021	
FACILITIES INTEGRATED SOLUTIONS & CONSULTING LLC	CYPRESS, TX	03/12/2021			
Facilities Sources (Dura Pier Facilities Services Ltd.)	Houston, TX	03/12/2021	Submitted	05/06/2021	05/06/2021
Facilities USA LLC	Brownsville, TX	03/12/2021			
Facility Response Group	San Marcos, TX	03/12/2021			
Facility Solutions Group	houston, TX	03/12/2021			
Falkenberg Construction Company, Inc.	Grand Prairie, TX	03/12/2021	Submitted	05/06/2021	05/06/2021
Fazangelo Prosperity LLC	the woodlands, TX	03/12/2021			
Ferguson Enterprises Inc	newport news, VA	03/12/2021			
FERN Environmental LLC	Houston, TX	03/12/2021			
Fielder's Choice, Inc.	Houston, TX	03/12/2021			
Filta (Seenandan LLC)	Houston, TX	03/12/2021			
FIRST NATIONAL HOMES,INC.	HUMBLE, TX	03/12/2021			
FISHER TRACKS, INC.	Boone, IA	03/12/2021			
Fix My Slab Foundation Repair (TDS Foundation Services)	Cypress, TX	03/12/2021			
FJW Construction Company	Austin, TX	03/12/2021			
Flagship Facility Services, Inc.	San Jose, CA	03/12/2021			
Flicgroup (Federal lighting illumination capital)	Southlake, TX	03/12/2021			
Flintco, LLC	Houston, TX		Submitted	05/07/2021	05/07/2021
FloorMasters (Cleaning Resource Systems Inc.)	Houston, TX	03/12/2021			
floors 2 adore	missori city, TX	03/12/2021			
Floor-Tex Commercial Flooring, LLC	Conroe, TX	03/12/2021			
Florida	Tallahassee, FL	03/12/2021			
Floyd Billings Construction LLC.	Dallas, TX, TX	03/12/2021			
FMG Construction Development	Houston, TX	03/12/2021			
FMG Construction Group, LLC	Houston, TX		Submitted	05/07/2021	05/07/2021
FMSG (Facilities Management Services Group)	St. Louis, MO	03/12/2021			
Foodservice Peeps LLC	Richmond, TX	03/12/2021			
Fort Bend Mechanical & Construction LLC	Stafford, TX	03/12/2021			
Foulke Rubber Products	Sun Prairie, WI	03/12/2021			
Foundation Specialists	Houston, TX	03/12/2021			
Four Seasons Development Co, Inc.	Houston, TX	03/12/2021			
FRAGMA Construction Services, LLC	Houston, TX	03/12/2021			
Frame-Work Consult	HOUSTON, TX	03/12/2021			
Freese and Nichols, Inc.	Fort Worth, TX	03/12/2021			
Frontier Services Group	Houston, TX	03/12/2021			
Frontier Waterproofing	Denton, TX	03/12/2021			
Frost Construction Company Inc.	Humble, TX	03/12/2021			
FRS Trenchcore	cypress, TX	03/12/2021			
FSI Construction, Inc.	Houston, TX	03/12/2021			

Ft Worth Refinishing (RUBBER DUCK LLC)	Arlington, TX	03/12/2021			
Fujitec America, Inc.	Carrollton, TX	03/12/2021			
G.I. Construction Management LLC	Celina, TX	03/12/2021	Viewed	04/27/2021	
G4C Enterprises, LLC	Pflugerville, TX	03/12/2021			
G5 Construction (G5 GC LLC)	cypress, TX	03/12/2021			
Gamma Construction	Houston, TX	03/12/2021			
Gary's Lonestar Pump LLC (Lone Star Pump Repair & Service)	New Caney, TX	03/12/2021			
Gazelle Capital, LLC	Saint Petersburg, FL	03/12/2021			
Geaux Crates & Storage, LLC	Houston, TX, TX	03/12/2021			
Gemini Services	Katy, TX	03/12/2021			
General Commercial Solutions, LLC	HOUSTON, TX	03/12/2021	Viewed	04/30/2021	
General Contractor Services, Inc.	Houston, TX	03/12/2021			
General Sports Surfaces LLC	Fort Worth, TX	03/12/2021			
Generocity Services Inc.	Friendswood, TX	03/12/2021	Submitted	05/03/2021	05/03/2021
Gene's Machine, INC.	Victoria, TX	03/12/2021			
GeoSolutions, Inc. (Southwest GeoSolutions, Inc.)	Austin, TX		Viewed	05/07/2021	
Gerloff Company Inc.	San Antonio, TX	03/12/2021			
Gilbane Building Company	Houston, TX	03/12/2021			
Glenn Mikeska Enterprises LLC	Brookshire, TX	03/12/2021			
Global Disaster Services, Inc.	Beaumont, TX	03/12/2021			
Global Waste Services LLC	Houston, TX	03/12/2021			
Goldstone Exterior Services	Houston, TX	03/12/2021			
Good of Boyz Plumbing (MDM Plumbing Services LLC)	Sanger, TX	03/12/2021			
graham county land company	Robbinsville, NC	03/12/2021			
Grassroots Construction & Maintenance LLC	Houston, TX	03/12/2021			
Graves Mechanical Inc	Houston, TX	03/12/2021			
Gray Mechanical (Gray Mechanical, LLC)	Houston, TX	03/12/2021			
Green Site, LLC	Elkridge, MD	03/12/2021			
Greywater Holding LLC dba X8 Environmental	LUBBOCK, TX	03/12/2021			
Groundbreaker Construction	Houston, TX	03/12/2021			
GSI Highway	Dallas, TX	03/12/2021			
Gulf Coast Boiler Service Co. (TK Boilers, LLC)	Houston, TX	03/12/2021			
Gulf Coast Painting & Construction	Harlingen, TX	03/12/2021			
Gulf States Laundry Machinery	Houston, TX	03/12/2021			
Gulftex (B J Interest, Inc.)	Houston, TX	03/12/2021			
Gutier Roofing & Sheet Metal (Gutier LLC)	HOUSTON, TX	03/12/2021	Submitted	05/07/2021	05/07/2021
GW Phillips Concrete Construction, Inc.	Houston, TX	03/12/2021			
H & H Skylight Fabricators, LLC	Stafford, TX	03/12/2021			
H.B. Neild & Sons, Inc.	Beaumont, TX	03/12/2021	Submitted	05/07/2021	05/07/2021
Haldeman Homme	Houston, TX	03/12/2021			
Hallmark Mitigation & Construction	Kingwood, TX	03/12/2021			
hard work construction	cleveland, TX	03/12/2021			
Hardy Construction (Hardy Stephenson LLC)	Milam,, TX	03/12/2021			
Hardy England, Spanco Building System	Round Rock, TX	03/12/2021			
Harness Roofing Inc.	Harrison, AR	03/12/2021			
Harris Construction (RJ Harris Construction (Gulf Coast)LP)	Humble, TX	03/12/2021			
Harrison, Walker & Harper, LP	Paris, TX	03/12/2021			
Harvest Innovative Solutions LLC	Pinehurst, TX	03/12/2021			
HB Construction	Albuquerque, NM	03/12/2021			
Heaton Electric, LLC	Waco, TX	03/12/2021			
Heavy Equipment Rentals of Texas (Golden Empire Equipment)	Pflugerville, TX	03/12/2021			
Heights Builders (Heights Commercial Paint Contractors, Inc.)	Houston, TX	03/12/2021			
Hendee Enterprises, Inc.	Houston, TX	03/12/2021			
HENECO ENGINEERING AND CONSULTING	Houston, TX	03/12/2021			
Henthorn Commercial Construction, LLC	Lubbock, TX	03/12/2021			
Heritage Institute of Sustainability LLC	Dallas, TX	03/12/2021			
Heritage One Roofing, Inc.	Dallas, TX	03/12/2021			
HG FIRE SYSTEMS, LP	HOUSTON, TX	03/12/2021			
High Access Solutions	Fort Worth, TX	03/12/2021			
Hilbrick Incorporated	West Lake Hills, TX	03/12/2021			
Hill & Wilkinson General Contractors	Richardson, TX	03/12/2021			



Hilti Inc	Plano, TX	03/12/2021			
HISD- CTE (Dummy Account)	Houston, TX	03/12/2021			
HJD Capital Electric, Inc.	San Antonio, TX	03/12/2021			
HOLES INCORPORATED	Houston, TX	03/12/2021			
Holtz/Adams Construction and Consulting, LLC	Universal City, TX	03/12/2021			
HomeBase Repairs, LLC	Stafford, TX	03/12/2021			
HOMETOWN HARDWARE (SCHIEL ENTERPRISE INC.)	WALLER, TX	03/12/2021			
Honesty Construction Group (HCG Management LLC)	Manvel, TX	03/12/2021			
Hoodz of Greater Houston & College Station (SparkySpark Inc)	Montgomery, TX	03/12/2021			
Hooper Strategies	Granbury, TX	03/12/2021			
Horizon International Group, LLC	Houston, TX	03/12/2021	No Bid	03/12/2021	04/01/2021
Horns Crew Trucking (Alvin Horn)	Longview, TX	03/12/2021			
Houston Elite Risk Management (T.R. Grace & Company, Inc.)	Houston, TX	03/12/2021			
Houtex Electric	Houston, TX	03/12/2021			
Hou-Tex Glass & Mirror Co (Hou Tex Newnom Inc.)	Houston, TX	03/12/2021			
HTX GROUP LLC	SOUTH HOUSTON, TX	03/12/2021			
Hubble Electronics, LLC (Same)	Houston, TX	03/12/2021			
Hudson Building Systems	Houston, TX	03/12/2021			
Humble Camera Center (Bradley E Crosby)	Humble, TX	03/12/2021			
Hunt and Associates Inc.	Harlingen, TX	03/12/2021			
Hunton Services (HVAC Mechanical Services of Texas LTD)	Houston, TX	03/12/2021			
Hyc0 Building Maintenance	Houston, TX	03/12/2021			
I/S Mechanical (Inno/lution)	Spring, TX	03/12/2021			
ICC Thermal Mapping and Data Analytcs (Infrared Concepts Corporation)	Maitland, FL	03/12/2021			
ICON Diversified, LLC	Weatherford, TX	03/12/2021	Submitted	05/03/2021	05/03/2021
IDG Services, Inc.	Richardson, TX		Unsubmitted	03/23/2021	
Idlewood Construction	Houston, TX	03/12/2021			
IFS Group Inc.	Houston, TX	03/12/2021			
IGH Contracting Services LLC	Pearland, TX	03/12/2021			
ILCOR Builders (Industrial Laminates Corporation)	Austin, TX	03/12/2021			
Illinois	Chicago, IL	03/12/2021			
illumiPure Corp.	Houston, TX	03/12/2021			
Imani Quality Concept LLC	Beaumont, TX	03/12/2021			
Imbue Cleaning Solutions	Augusta, GA	03/12/2021			
Imperial Construction, Ltd.	Weatherford, TX	03/12/2021			
IMS Dodge	San Diego, CA	03/12/2021			
Indiana	Indianapolis, IN	03/12/2021			
INFINITY CONTRACTORS INT'L LTD	FORT WORTH, TX	03/12/2021			
InnovsiteLLC	Decatur, GA	03/12/2021			
Institute for Building Technology and Safety	VA, VA	03/12/2021			
Integrity Pipeline Services	Pearland, TX	03/12/2021			
Interfacing Company of Texas	Houston, TX	03/12/2021			
INTERNATIONAL PROPERTY DEVELOPMENTS LLC DBA THE SIGNATURE GROUP	Port Neches, TX	03/12/2021			
Interprise/Southwest Interior & Space Planning, In	Addison, TX	03/12/2021			
Interstate Restoration LLC	Fort Worth, TX	03/12/2021			
Ion Wave Support	Springfield, MO		Viewed	05/07/2021	
Iowa State	Des Moines, IA	03/12/2021			
I-Raos, Inc	Pearland, TX	03/12/2021			
ISES Corporation	Duluth, GA	03/12/2021			
iSqFt® and Houston AGC plan room	Houston, TX	03/12/2021			
IT Installs (BBSC Corp)	Sarasota, FL	03/12/2021			
J C Currey	El Paso, TX	03/12/2021			
J Frank Consulting (Joan Frank)	Fairfield, TX	03/12/2021			
J Reynolds & Co., Inc.	Saginaw, TX	03/12/2021			
J THOMAS II CONSTRUCTION, LLC	Angleton, TX	03/12/2021			
J&E Associates (JE Specialities)	Houston, TX	03/12/2021			
J.L. Squared Construction	Corpus Christi, TX		Submitted	05/07/2021	05/07/2021

J.S. Electric, Inc.	Buda, TX	03/12/2021		
J2 General, LLC	Cedar Park, TX	03/12/2021		
JABG Construction & Engineer (Thomas 11 Development LLC)	Dallas, TX	03/12/2021		
Jahmor Janitorial Services	Houston, TX	03/12/2021		
Jamail & Smith Construction, LP	Houston, TX	03/12/2021		
JAMCO ELECTRICAL (JESUS TREVINO)	HOUSTON, TX	03/12/2021		
Jarrar & Company, Inc.	Houston, TX	03/12/2021		
JAX CONSTRUCTION	MISSION, TX	03/12/2021		
Jaymark Engineering Corporation	Houston, TX	03/12/2021		
JBRI Construction Services, LLC	Pinehurst, TX	03/12/2021		
JC Stonewall Constructors, LP	Houston, TX	03/12/2021		
JEFF EUBANK ROOFING CO., INC.	Fort Worth, TX	03/12/2021		
Jeffrey's Landscaping	Harlingen, TX	03/12/2021		
Jeff's Mechanical Service	Houston, TX		Unsubmitted	04/13/2021
JEGAS Construction	Houston, TX	03/12/2021		
JERICO FOUNDATION REPAIR	HOUSTON, TX	03/12/2021		
JESCO Environmental & Geotechnical Services	Jennings, LA	03/12/2021		
Jet Industrial Service Group	Vidor, TX	03/12/2021		
Jim E Owens, Facilities Consulting, LLC	Channelview, TX	03/12/2021		
Jimtex Electric LLC	Houston, TX	03/12/2021		
JKAJ SERVICE CORP, LLC	Houston, TX	03/12/2021		
JLA Construction Solutions	Houston, TX	03/12/2021		
JLL (Jones Lang LaSalle, Americas, Inc.)	Houston, TX	03/12/2021		
JM Construction Solutions (JM Management LLC)	Dallas, TX	03/12/2021		
JM Sales & Services	Galveston, TX	03/12/2021		
JNJ RESURFACING DBA (JUAN JESUS ZAMORA)	HOUSTON, TX	03/12/2021		
Jon M. Warren, LLC	Decatur, TX	03/12/2021		
Jones Lang LaSalle (JLL)	Houston, TX	03/12/2021		
Jonmar Electric, Inc.	Houston, TX	03/12/2021		
Jorrie Martin LLC	San Antonio, TX	03/12/2021		
Journeys Managing Group LLC	Houston, TX	03/12/2021		
JR Thomas Group, Inc.	Houston, TX	03/12/2021		
JSHardfy, llc	Cypress, TX	03/12/2021		
JUST CONSTRUCTION	Houston, TX	03/12/2021		
Jv-janitorial	Fortworth, TX	03/12/2021		
K & S Contracting, Inc	Cypress, TX	03/12/2021		
K S Restoration, Inc.	Arlington, TX	03/12/2021		
K.R. Allen Industrial Services, LLC (K.R. Allen Construction, LLC)	Bacliff, TX	03/12/2021		
Kaiser International, Inc	Houston, TX		Submitted	05/07/2021 05/07/2021
KANKO (Floyd's Chores & Odd Jobs)	Dallas, TX	03/12/2021		
Kansas	Topeka, KS	03/12/2021		
Kendnel Kasper Construction	Fredericksburg, TX	03/12/2021		
Kentech Inc.	Porter, TX	03/12/2021		
Kes Maid llc	Spartanburg, SC	03/12/2021		
Key HTX Development & Holdings	HOUSTON, TX	03/12/2021		
Key Installations LLC	Crosby, TX	03/12/2021		
KIKO Construction (KIKOCon, Inc.)	Harlingen, TX	03/12/2021		
Kilgore Industries	Houston, TX	03/12/2021		
Kingham Dalton Wilson, Ltd.	Houston, TX	03/12/2021		
Kitchell Contractors	Austin, TX	03/12/2021		
Kitchen rescue	Round Rock, TX	03/12/2021		
Kiwi Services	Carrollton, TX	03/12/2021		
Kline Technical Consulting, LLC	Austin, TX	03/12/2021		
KMD Hospitality (KMD Hospitality LLC)	Humble, TX	03/12/2021		
Knight Restoration Services	Addison, TX	03/12/2021		
KQC Investors, LLC	Lewisville, NC	03/12/2021		
KR Allen Construction, LLC	Bacliff, TX	03/12/2021		
Kriston Construction Company Inc	Beaumont, TX	03/12/2021		
L&S Associates, LLC	Montgomery, TX	03/12/2021		
L.D. Bundren Painting, Inc.	Katy, TX	03/12/2021		
Lady Liberty Group LLC	Eules, TX	03/12/2021		
Lake Air Interiors (Focused Contractor Services)	Waco, TX	03/12/2021		
Landmarc Holding, LLC	Forth Worth, TX	03/12/2021		
Landmark Electric Company (Landmark Electric Co.)	Corpus Christi, TX	03/12/2021		

Landscape Management Services (LMS Inc.)	Houston, TX	03/12/2021			
Lange Mechanical Services, L.P.	Houston, TX	03/12/2021	Viewed	05/07/2021	
LanMarc Construction (Marti M. Carder)	West Columbia, TX	03/12/2021			
LaTx Construction Services	Houston, TX	03/12/2021			
Launch Point CDC, Inc.	Houston, TX	03/12/2021			
Lawnsapes Unlimited	Rosharon, TX	03/12/2021			
LBNM Corporation	Richmond, TX	03/12/2021			
LD Tebben Company, Inc.	Austin, TX	03/12/2021			
LDG Facility Services LLC	Houston, TX	03/12/2021			
Learn, Play and Discover Academy	Crosby, TX	03/12/2021			
Leather Only Products	Houston, TX	03/12/2021			
Lee Services Inc.	New Caney, TX	03/12/2021			
Lessman Roofing and Sheet Meda	Conroe, TX	03/12/2021			
level C 3 Construction	crosby, TX	03/12/2021			
Level Infrastructure LLC	Houston, TX	03/12/2021			
Levys On The Run Landscaping & Janitorial Services LLC	baton rouge, LA	03/12/2021			
Levy's Tutorial and Enrichment Center (Mary Baumann)	Houston, TX		No Bid	04/01/2021	04/01/2021
Lighthouse Construction, LLC	Burnet, TX	03/12/2021			
Lime Energy (Texas Energy Products Inc)	Elk Grove Village, IL	03/12/2021			
Linc Service, LLC	Houston, TX	03/12/2021			
Lindsey Electric, L.P.	Houston, TX	03/12/2021			
Link Staffing Services (Stafflink, Inc.)	Houston, TX	03/12/2021			
LMC Corp (Lee Construction and Maintenance)	Houston, TX	03/12/2021	Submitted	05/07/2021	05/07/2021
LMS Commercial Services (LMS Restoration)	Paris, TX	03/12/2021			
Lockwood, Andrews & Newnam, Inc.	Houston, TX	03/12/2021			
Logical Solutions, Inc	Richardson, TX	03/12/2021			
Logistical Concepts LLC	Humble, TX	03/12/2021			
Logistical Maintenance	Houston, TX	03/12/2021			
Lone Star Waterproofing Inc	Irving, TX	03/12/2021			
LongCrete (Longhill Group, Inc.)	Argyle, TX	03/12/2021			
Lorraine Construction, Inc.	Angleton, TX	03/12/2021			
Lowes Companies Inc	Moorestville, NC	03/12/2021			
L-Sync, LLC	Grand Prairie, TX	03/12/2021			
Luchazie Construction (Luchazie General Store and Restaurant dba Luchazie Construction)	San Diego, TX	03/12/2021			
LUMAR Ventures (Luis M Dueno Medina)	San Antonio, TX	03/12/2021			
LVC Technologies, LLC	Rosenberg, TX	03/12/2021			
Lynx Contractors, Inc.	San Marcos, TX		Viewed	04/29/2021	
M SPACE (M Space Holdings, LLC)	PArk City, UT	03/12/2021			
M&H Lighting Systems (Mapenzi Group)	Pearland, TX	03/12/2021			
Macias Constructions, LLC	Houston, TX	03/12/2021			
MAF ENTERPRISES, INC.	HOUSTON, TX	03/12/2021			
MAGIC ONE SERVICES LLC	Spring, TX	03/12/2021			
Magnum Air Inc	Montgomery, TX	03/12/2021			
MainStage Theatrical Supply	Milwaukee, WI	03/12/2021			
Majestik Industries, L.L.C.	Humble, TX	03/12/2021			
Major League Roofing	Frisco, TX	03/12/2021			
Mako Industries (Mako Olifield Services DBA Mako Industries)	Houston, TX	03/12/2021			
Maldonado Nursery & Landscaping, Inc.	San Antonio, TX	03/12/2021			
Mammoth Roofing Services (Mammoth Services, LLC)	Houston, TX	03/12/2021			
Marcis & Associates, Inc.	Spring, TX	03/12/2021			
Mark Collins Construction LLC	League City, TX	03/12/2021			
Marksmen General Contractors, Inc.	San Antonio, TX	03/12/2021			
Marles enerprises, LLC	South Portland, ME	03/12/2021			
Marseal Group	Roanoke, TX	03/12/2021			
Marsh Waterproofing, Inc	Vidor, TX	03/12/2021			
Mart, Inc.	Irving, TX	03/12/2021			
Martek Industries Inc	Cherry Hill, NJ	03/12/2021			
Massachusetts	Boston, MA	03/12/2021			
Mav-Con LLC	Laredo, TX	03/12/2021			
MCA Communications	Houston, TX	03/12/2021			
McCrory Engineering	Houston, TX	03/12/2021			
McCune Electrical Service	Hosuton, TX	03/12/2021			

Mcdaniel Builders Inc	Montgoery, TX	03/12/2021			
McGee Electrical Services, Inc.	Irving, TX	03/12/2021			
McGraw-Hill Construction /Dodge Reports	Arlington, TX	03/12/2021			
McGriff Seibels and williams	Houston, TX	03/12/2021			
McKenna Contracting, Inc	Spring, TX	03/12/2021			
McKinstry (McKinstry Essention, Inc.)	Dallas, TX	03/12/2021			
MCS Enterprises	Houston, TX	03/12/2021			
McVey Paint & Wallcovering, Inc.	Magnolia, TX	03/12/2021			
METCO Engineering, Inc.	Dallas, TX		Submitted	05/07/2021	05/07/2021
Mezquite Installation Inc	Dallas, TX	03/12/2021			
MGS Supply & Services	Katy, TX	03/12/2021			
MHE Intermediate Holdings,LLC (Miner Houston, Ltd)	San Antonio, TX	03/12/2021			
Michael S Homes Jr (Michael S. Homes Jr.)	Erath, LA	03/12/2021			
Mid America Metals (Renaissance Metals, In.c)	Ozark, MO	03/12/2021			
Mid South Lubrication Systems (Mid South Engine and Machine)	White Oak, TX	03/12/2021			
Mid-America Contractors, LLC (Mid-America Metal Roofing & Siding Installed, LLC)	Port Arthur, TX	03/12/2021			
Mid-Continental Restoration Company, Inc.	Fort Scott, KS	03/12/2021	Submitted	05/07/2021	05/07/2021
Midessa Electric LLC	Midland, TX	03/12/2021			
Mid-South Waterproofing Systems, Inc	Houston, TX	03/12/2021			
Midstate Energy, LLC, A Veregy Company	Phoenix, AZ	03/12/2021			
Midstream and Terminal Services	Houston, TX	03/12/2021			
Milam & Co. Painting, Inc.	Houston, TX	03/12/2021			
Millennium Project Solutions, Inc.	Crosby, TX	03/12/2021			
Minnesota	St. Paul, MN	03/12/2021			
Miracle Method of Austin (Nartor Associates Inc)	Austin, TX	03/12/2021			
Miracle Method Surface Refinishing	Colorado Springs, CO	03/12/2021			
Mississippi	Jackson, MS	03/12/2021			
Missouri	Jefferson City, MO	03/12/2021			
Mitchell Contracting	Houston, TX	03/12/2021	Submitted	05/07/2021	05/07/2021
MJ McMurrey Construction LLC	Houston, TX	03/12/2021			
MJR EDUCATIONAL SUPPLIES	Houston, TX	03/12/2021			
ML Deer Construction	Houston, TX	03/12/2021			
MMS-TX GROUP, LLC	PORTER, TX	03/12/2021			
Modernized Designs, LLC	Fresno, TX	03/12/2021			
ModSpace (Modular Space Corporation)	Berwyn, PA	03/12/2021			
Modular Management Group, Inc.	Fort Worth, TX	03/12/2021			
MODULAR SOLUTIONS, LTD	PHOENIX, AZ	03/12/2021			
Molitor Enterprises (Larry Molitor)	Huntsville, TX	03/12/2021			
Montgomery Building Services LLC	Montgomery, TX	03/12/2021			
Moore Supply Company (Hajoca)	Houston, TX	03/12/2021			
Mooring Recovery Services	Grand Prairie, TX	03/12/2021	Viewed	04/28/2021	
Morales Construction Services, Inc.	Mansfield, TX	03/12/2021			
MPACT STRATEGIC CONSULTING, LLC	Houston, TX	03/12/2021			
Mr Electric of NW Houston	HOUSTON, TX	03/12/2021			
MTC Exterior Maintenance	Richmond, TX	03/12/2021			
MultiDrain Systems, Inc.	Statesville, NC	03/12/2021			
Multivista (Multivista Systems, LLC)	Dallas, TX	03/12/2021			
MW Services Inc.	Temecula, CA	03/12/2021			
MYCON GENERAL CONTRACTORS	College Station, TX	03/12/2021			
Myelyn Contractors	Plano, TX	03/12/2021			
Myron Mcdowell Construction	Dayton, TX	03/12/2021			
N&T Construction Co., Inc	Beaumont, TX	03/12/2021			
Nacogdoches Iron Works, Inc.	Nacogdoches, TX	03/12/2021			
NAH Sports Flooring, LLC	Houston, TX	03/12/2021			
Namco Dallas (Namco Cleaning Solutions Inc)	Irving, TX	03/12/2021			
Nash Industries, Inc.	Katy, TX	03/12/2021			
National Glazing Solutions, LLC	Garland, TX	03/12/2021			
Native Construction (Native Consolidated Management LLC)	Houston, TX	03/12/2021	Submitted	05/04/2021	05/04/2021
NCRI-National Catastrophe Restoration, Inc	Wichita, KS	03/12/2021			
Near Future LLC	Dallas, TX	03/12/2021			
NEIL TECHNICAL SERVICES CORP	houston, TX	03/12/2021			
Nester Enterprises	San Antonio, TX	03/12/2021			
Network Cabling Services, Inc.	Houston, TX	03/12/2021			

Neutex Advanced Energy Group, Inc	Houston, TX	03/12/2021		
New World Contracting, LLC	Bellaire, TX	03/12/2021		
New York	New York, NY	03/12/2021		
NextGen Bin Cleaning	McKinney, TX	03/12/2021		
NJAC Construction	Seabrook, TX	03/12/2021		
No Fa	Baton Rouge, LA	03/12/2021		
No Slip, Just Grip LLC	CORPUS CHRISTI, TX	03/12/2021		
Nobe Nash, Inc	Houston, TX	03/12/2021		
North Carolina	Raleigh, NC	03/12/2021		
North Texas Safe Sidewalks LLC	Nocona, TX	03/12/2021		
Nouveau Construction and Technology Services (Nouveau Technology Services, LP)	Carrollton, TX	03/12/2021		
NVS Corporate Services, Inc.	Brownsville, TX	03/12/2021		
OBELLO, INC	Dallas, TX	03/12/2021		
O'Donnell/Snider Construction	HOUSTON, TX		Viewed	04/28/2021
Office Shines (CallWorksMedia,LLC)	Stafford, TX	03/12/2021		
Ohio State	Columbus, OH	03/12/2021		
OLVAZ Construction Inc.	Humble, TX	03/12/2021		
Omega Builders Group, L.P.	Houston, TX	03/12/2021		
Omega Engineers, Inc.	Houston, TX	03/12/2021		
Omega Roofing & Construction	Houston, TX	03/12/2021		
On Time Solutions (Dura Pier - TX, Inc.)	Houston, TX	03/12/2021		
One More Round Inc	Houston, TX	03/12/2021	No Bid	03/17/2021 03/19/2021
OnePoint, Inc.	Houston, TX	03/12/2021		
OneTeam	Syracuse, NY	03/12/2021		
OpTerra Energy Services, Inc.	Overland Park, KS	03/12/2021		
Oregon	Salem, OR	03/12/2021		
Ortiz Construction Group LLC	Kyle, TX	03/12/2021		
Palacios Marine & Industrial Coatings, Inc.	Palacios, TX	03/12/2021		
Palm Building Care (New Palm Services LLC)	Austin, TX	03/12/2021	Viewed	05/07/2021
Palomar Modular Buildings, LLC	DeSoto, TX	03/12/2021		
Panhandle Steel Buildings, Inc	Amarillo, TX	03/12/2021		
PARADISE AIR (Luck & Logic Inc.)	Kemah, TX	03/12/2021		
Paramount Metal Systems, LLC	Little Rock, AR	03/12/2021		
Patriot Contracting LLC	Houston, TX	03/12/2021	Viewed	04/27/2021
Patriot Fence Company (Aquarius Chemical)	Midland, TX	03/12/2021		
Patriot Medical Solutions, LLC	Coral Springs, FL	03/12/2021		
PB&J Pavement Marking, Inc.	Sugar Land, TX	03/12/2021		
PCJ Consultants Inc.	Rosharon, TX	03/12/2021		
PECOS FENCE, INC.	SAN ANTONIO, TX	03/12/2021		
Penhall Company	Houston, TX	03/12/2021		
Pennsylvania	Harrisburg, PA	03/12/2021		
Peoples' Door & Glass	Houston, TX	03/12/2021		
Performance Services, Inc.	Dallas, TX	03/12/2021		
Petro Progressive Services	THE WOODLANDS, TX	03/12/2021		
Pfeiffer & Son, Ltd.	La Porte, TX	03/12/2021	Viewed	05/03/2021
PHD Resources & Taxes	Houston, TX	03/12/2021		
Phoenix Architectural Products, Inc.	Smyrna, GA	03/12/2021		
PIATRA INC	Austin, TX	03/12/2021		
PIC Printing	Fort Worth, TX	03/12/2021		
Pick Two Interprise,LLC	Crosby, TX	03/12/2021		
Piling Products	Green Cove Springs,, FL	03/12/2021		
PL2O Construction & Consultancy	Sugar Land, TX	03/12/2021		
Platinum Fire Protection LLC	Pearland, TX	03/12/2021		
PMG PROJECT MANAGEMENT GROUP, LLC	Houston, TX	03/12/2021		
Point Alliance Solutions	Spring, TX	03/12/2021	Submitted	05/07/2021 05/07/2021
Polygon US Corporation	North Andover, MA	03/12/2021		
PopSmart Technologie, LLC (PopSmart Technologies,LLC)	Farmers Branch, TX		No Bid	03/31/2021 03/31/2021
Post L Group, LLC	Houston, TX	03/12/2021	Unsubmitted	04/15/2021
Post Oak Construction LLC	Houston, TX	03/12/2021		
Power Field Services (Marine Connection Services, Inc.)	Dickinson, TX	03/12/2021		
Power of Choosing Inc.	Texas, TX	03/12/2021		
Power Pro-Tech Services	Altamonte Springs, FL	03/12/2021		
Precision Management Solutioin Inc.	Ellenwood, GA	03/12/2021		
Premier Metalwerks, LLC	Haltom City, TX	03/12/2021		

Premier Shade Design, LLC (Muse)	San Antonio, TX	03/12/2021			
Presidential Staffing Solutions	San Antonio, TX	03/12/2021			
Prestige Building Maintenance	Houston, TX	03/12/2021			
Prestigious Sports Outfitters (Rogers)	McKinney, TX	03/12/2021			
Prime Facility Services Group, Inc.	Houston, TX	03/12/2021			
Prime Maintenance & Construction	Alice, TX	03/12/2021			
Primero Industrial Services, LTD.	Santa fe, TX	03/12/2021			
Prism Electric	Dallas, TX	03/12/2021			
Prodigy Construction Management, LLC	McAllen, TX	03/12/2021			
Project Management Consultant LLC	Jackson, MS	03/12/2021			
Proposal Riordan	Austin, TX	03/12/2021			
Pro-Tech Facility Restoration, LLC	Sugar Land, TX	03/12/2021			
PROTECHT Management Group, LLC	Austin, TX	03/12/2021			
PSA Constructors Inc.	Dallas, TX	03/12/2021			
PTY Contractors LLC	Jacksonville, FL	03/12/2021			
PTY Multiservices, LLC	Kingwood, TX	03/12/2021			
Pumps of Houston, Inc.	Houston, TX	03/12/2021			
Pure Clean Building Services	washington park, IL	03/12/2021			
Pure Speed Lightwave	Houston, TX	03/12/2021			
Pyramid Imports Tile & Flooring, Inc.	Houston, TX		Viewed	05/06/2021	
Pyrotex Systems	Alvin, TX	03/12/2021			
QC7 Development Services, Ltd.	Charlotte, NC	03/12/2021			
Q-Star Technology	Torrance, CA	03/12/2021			
Quadra Mind Enterprise, Inc.	Houston, TX	03/12/2021			
Quad-Tex Construction, Inc	College Station, TX	03/12/2021	Submitted	05/06/2021	05/06/2021
Quality Renovations and Construction	Houston, TX	03/12/2021			
Quasar Data Center	Houston, TX		Submitted	05/06/2021	05/06/2021
R&L Building Group	Houston, TX	03/12/2021			
R&T Architects, Inc.	Houston, TX	03/12/2021			
R.L. ROHDE GENERAL CONTRACTING, INC.	ADKINS, TX	03/12/2021			
Rachel Bryant CO	Austin, TX	03/12/2021			
Radius Design Works, LLC	Cincinnati, OH	03/12/2021	Submitted	05/07/2021	05/07/2021
Rainbow International of Nacogdoches (Henderbi LLC)	Nacogdoches, TX	03/12/2021			
Rainbow International of Weatherford	Weatherford, TX	03/12/2021			
Rainbow International of Webster	Friendswood, TX	03/12/2021			
Rainbow International Restoration of San Antonio (Restoration Ventures Inc)	San Antonio, TX	03/12/2021			
RAM Roofing Services LLC	Southlake, TX	03/12/2021			
Ramtech Building Systems (Ramtech Building Systems, Inc)	Mansfield, TX	03/12/2021			
Raus Construction LTD.	Houston, TX	03/12/2021			
RBR Construction, Inc.	Weatherford, TX	03/12/2021			
RCK Equipment Solutions (Curtis Collins and Katina Collins)	Cleveland, TX	03/12/2021			
RCS Roofing & Sheet Metal	Denton, TX	03/12/2021			
RDI Mechanical	Houston, TX	03/12/2021	Submitted	04/22/2021	04/22/2021
Ready Trans Limited Liability Company	Frisco, TX	03/12/2021			
Real Network Services, Inc. (Crosley)	Dallas, TX	03/12/2021			
Red Rocket Electric	Houston, TX	03/12/2021			
Red Rocket Electric Llc	Houston, TX	03/12/2021			
Redd Team by Sapa	Magnolia, AR	03/12/2021			
Reed construction data	Norcross, GA	03/12/2021			
Reeder Concrete, Inc.	Irving, TX	03/12/2021			
Refrigeration Technologies, LLC	Pottstown, PA	03/12/2021	Viewed	05/07/2021	
RegeniSource (RegeniSource LLC)	San Antonio, TX	03/12/2021			
Regiment Commercial Construction	Round Rock, TX	03/12/2021			
Remedy Contractors	Katy, TX	03/12/2021			
Remy Dillenseger	Houston, TX		No Bid	04/06/2021	04/06/2021
Renaissance Power Conservation	Norfolk, VA	03/12/2021			
Renegade Construction LLC	League City, TX	03/12/2021			
Renovate Paint and Design (CLL Specialists, Corp.)	San Antonio, TX	03/12/2021			
Restoration Services, Inc. (A & E Tech Reps)	Houston, TX	03/12/2021	Submitted	05/06/2021	05/06/2021
Restoration Specialists (Restoration Specialists, LLC)	Addison, TX	03/12/2021			
Revitalize Maintenance, LLC	Houston, TX	03/12/2021			

Rhode Island	Providence, RI	03/12/2021			
Right Choice cleaning & Restoration	Houston, TX	03/12/2021			
Right Choice Materials Company	Houston, TX	03/12/2021			
Rio Roofing, Inc.	Harlingen, TX	03/12/2021			
Roadrunner Restoration (Progressive Fire & Flood, Inc)	HOUSTON, TX	03/12/2021			
Rob Pelletier Construction, Inc	Houston, TX	03/12/2021			
Roberto Gamez (RP COS MANAGEMENT INC)	HUMBLE, TX	03/12/2021			
Rolland Safe and Lock Company	DALLAS, TX	03/12/2021			
RoofCARE	Houston, TX	03/12/2021			
RoofConnect Logistics, Inc	Sheridan, AR	03/12/2021			
Roofing Designs by JR LLC (OEG Construction and Services)	HUMBLE, TX	03/12/2021			
Royal American Services, Inc.	Bellaire, TX	03/12/2021			
Royalty by DeZign LLC	El Mirage, AZ	03/12/2021			
RR CONNECTION CONSULTING	Duncanville, TX	03/12/2021			
RS3 Turf	round rock, TX	03/12/2021			
Rubber Flooring Systems, Inc.	Kemah, TX	03/12/2021			
Rudd Plumbing Company (Rudd Contracting Co., Inc.)	Tyler, TX	03/12/2021			
S Corporation	Phila, PA	03/12/2021			
SAB Industries LLC	Houston, TX	03/12/2021	No Bid	03/17/2021	03/17/2021
Sabre Commercial	Austin, TX	03/12/2021			
SAK Construction, LLC	O'Fallon, MO	03/12/2021			
Saldana Architects	San Antonio, TX	03/12/2021			
Salone Capital LLC	Rockport, TX	03/12/2021			
SAMES, INC.	McAllen, TX	03/12/2021			
Sams Pack's five star ford	farmers branch, TX	03/12/2021			
Saratoga Roofing & Construction (Mountain Top Enterprises, LLC)	OKC, OK	03/12/2021			
Satellite Shelters, Inc.	Minneapolis, MN	03/12/2021			
Sav-On Fence Inc.	Haslet, TX	03/12/2021			
Sawduzt Services, LLC.	Tomball, TX	03/12/2021			
SBA Houston (US Small Business Administration)	Houston, TX	03/12/2021			
SBM General Contractor, LLC	Mico, TX	03/12/2021			
SCHRAMME CONSTRUCTION	RICHMOND, TX	03/12/2021			
Scogin Aire Mechanical (Scogin Aire Mechanical)	Conroe, TX	03/12/2021			
Scope Builders LLC	Houston, TX	03/12/2021			
Scope28	Houston, TX	03/12/2021			
Scott Beck Construction.Inc	North Richland Hills, TX	03/12/2021			
Scott Dennett Construction, LC	FORT WORTH, TX	03/12/2021			
SDB Contracting Services (SDB, Inc)	Tempe, AZ	03/12/2021	Submitted	05/07/2021	05/07/2021
Seahurst Energy Services (Seahurst Electric)	Everett, WA	03/12/2021			
SealWrap Installation, Inc	Allentown, PA	03/12/2021			
SEMI USA CORPORATION	BETHSEDA, MD	03/12/2021			
Seneca Mechanical LLC	Nolanville, TX	03/12/2021			
Serenity Floor Care (Dirt Free Carpet & Tile Cleaning LLC)	Katy, TX	03/12/2021			
ServiceMaster by ABC Services (Phil Bryant)	Houston, TX	03/12/2021			
ServiceMaster by Centex (CSTR Services LLC)	Waco, TX	03/12/2021			
ServiceMaster Recovery Management (Service Environments of Texas, Inc.)	Kingwood, TX	03/12/2021			
SERVPRO of Bear Creek (SPBC, LLC)	Houston, TX	03/12/2021			
Servpro of Beaumont (Triangle Restoration)	Beaumont, TX	03/12/2021			
SERVPRO of Friendswood/Pearland (ABM Restoration, LP)	Pearland, TX	03/12/2021			
SERVPRO of Metro-Pittsburgh (MKS Services, Inc.)	North Versailles, PA	03/12/2021			
SERVPRO of North Central Austin (Clean Slate Service, Inc.)	Austin, TX	03/12/2021			
Servpro of Pflugerville (Dimensions CLC, LLC)	Leander, TX	03/12/2021			
SERVPRO of Spring/Tomball (AKS Holdings, Inc.)	Tomball, TX	03/12/2021			
SERVPRO of Stafford/Missouri City (Hollen Enterprises Inc)	Missouri City, TX	03/12/2021			
Servpro of the Woodlands/Conroe (S & R Operations, Inc.)	Houston, TX	03/12/2021			

Servpro of Town & Country, Servpro of Clear Lake (Jagwood, Inc.)	Houston, TX	03/12/2021		
Servpro of Westfield (G&K Godwin Enterprises, Inc)	Houston, TX	03/12/2021		
Session Tax Consulting & Grant Writing (Session Tax Consulting and grant writing)	HOUSTON, TX	03/12/2021		
SETEX Facilities & Maintenance, LLC	Beaumont, TX	03/12/2021		
Seyforth Services (Seyforth Services Inc)	Dallas, TX	03/12/2021		
Sharpline Coatings LLC	Harlingen, TX	03/12/2021		
Shaw Industries, Inc	Dalton, GA	03/12/2021		
Shepard Forest (4325 Costa Rica, LLC DBA Shepard Forest)	Houston, TX	03/12/2021		
SI Restoration	Baltimore, MD	03/12/2021		
Siemens Industry, Inc	Houston, TX	03/12/2021		
Sigga Workforce Technologies	Sugar Land, TX	03/12/2021		
Sign Pro	Bryan, TX	03/12/2021		
Signature Electric Services, LLC	Huffman, TX	03/12/2021		
Signs of Success	Houston, TX	03/12/2021		
Sitek Omni Services, LLC	Humble, TX	03/12/2021		
Sky Spotless Cleaners (ADAM NAMAL)	Katy, TX	03/12/2021		
SLL Services, LLC	Palestine, TX	03/12/2021		
Smart Pump Solutions, LLC.	Houston, TX	03/12/2021		
Smart Roofing Solutions	Houston, TX	03/12/2021		
Smart Scholars Foundation	Houston, TX	03/12/2021		
SMC Logistics	Stafford, TX	03/12/2021		
Sodexo Services of Texas Limited Partnership	Gaithersburg, MD	03/12/2021		
Solenetric, Inc.	Houston, TX	03/12/2021		
Solidarity Contracting llc	houston, TX	03/12/2021		
Solomie B LLC	fountain inn, SC	03/12/2021		
SOTERIA SAFETY SERVICES LLC	ALVIN, TX	03/12/2021		
South Carolina	Columbia, SC	03/12/2021		
south texas boiler	houston, TX	03/12/2021		
SOUTH TEXAS PUMP INC	WESLACO, TX	03/12/2021		
South Texas Shop Services	Friendswood, TX	03/12/2021		
Southeast Technical Solutions	League City, TX	03/12/2021		
Southeast Texas Drywall, LLC	Beaumont, TX	03/12/2021		
Southern Customs, Inc.	HOUSTON, TX	03/12/2021		
Southern Prairie Mechanical LLC	Humble, TX	03/12/2021		
SOUTHWEST WHOLESALE LLC	HOUSTON, TX	03/12/2021		
Sparkling Clear Industries	CLUTE, TX	03/12/2021		
Spartan National Construction Company	Fort Worth, TX	03/12/2021		
SpawGlass Construction Corp.	Beaumont, TX	03/12/2021		
Specialty Commercial Contractors	Carrollton, TX	03/12/2021		
Specialty Painting & Wallcovering, Inc.	Nederland, TX	03/12/2021		
SpecPro, Inc.	Papillion, NE	03/12/2021		
Spigener Developement Inc.	Pasadena, TX	03/12/2021		
sport systems unlimited	waterloo, TX	03/12/2021		
Spur Employment, Inc.	HUNTSVILLE, AL	03/12/2021		
SRS Distribution Inc.	McKinney, TX	03/12/2021		
SSCI Environmental (Separation Systems Consultants, Inc.)	Houston, TX	03/12/2021		
Staff 4 Houston (TX Citywide Pro Services)	Houston, TX	03/12/2021		
Standard Morgan Partners, LTD	Houston, TX	03/12/2021		
Stanley Convergent Security	Houston, TX	03/12/2021		
Star Interior Resources (STARSD, Inc.)	Dallas, TX	03/12/2021		
STATE FEDERAL CONTRACTORS	AUSTIN, TX	03/12/2021		
Stephens Fire Protection Group LLC	Robinson, TX	03/12/2021		
Sterling Structures, Inc.	Houston, TX	03/12/2021	Submitted	05/06/2021 05/06/2021
Stewart Builders, Inc.	Houston, TX	03/12/2021		
Stiff LLC	HOUSTON, TX	03/12/2021		
STL Supply Company	Houston, TX	03/12/2021		
STOA Architects	Houston, TX	03/12/2021		
Stonhard Resinous Flooring (StonCor Group Inc)	Maple Shade, NJ	03/12/2021		
Straight Line Management (Straight Line Management LLC)	San Antonio, TX	03/12/2021		
Strategic Partnerships, Inc.	Austin, TX	03/12/2021		
STRAUS SYSTEMS INC	STAFFORD, TX	03/12/2021		



StrongGlass Systems (MGT Films)	Wauconda, IL	03/12/2021			
Structura Design LLC	Houston, TX	03/12/2021			
Sublime HVAC Services	alice, TX	03/12/2021			
Sullivan Contracting Services (Pounds Group, LLC)	Seguin, TX	03/12/2021	Submitted	05/06/2021	05/06/2021
Sunrise Construction (Santa Fe Sunrise Construction)	Alvin, TX	03/12/2021			
Sunsational Solutions (Ten Twenty Four Industries, LLC)	Austin, TX	03/12/2021			
Supreme Crane and Rigging LLC	Porter, TX	03/12/2021			
Survive-a-Storm Shelters	Thomasville, GA	03/12/2021			
Swift Electric LLC	SEALY, TX	03/12/2021			
Swinerton	Austin, TX	03/12/2021			
Symone Construction Services, LLC	Cedar Hill, TX	03/12/2021			
T & C Construction, LTD	Houston, TX	03/12/2021			
T&G Constructors (T&G Corporation)	Orlando, FL	03/12/2021			
T.F. Harper & Associates, LP	Austin, TX	03/12/2021			
TAD 3 ENTERPRISES INC	Houston, TX	03/12/2021			
Tailored Door & Glass Co., Inc	Pearland, TX	03/12/2021			
Tandus Centiva US LLC	Dalton, GA	03/12/2021			
Target Restoration Services (TRSI)	Waco, TX	03/12/2021			
Tates Contracting, LLC	Houston, TX	03/12/2021			
Taylor Nicole	Fresno, TX	03/12/2021	Unsubmitted	05/07/2021	
TCH (Alcott, Inc)	Friendswood, TX	03/12/2021			
TDC Waterproofing & Restoration, LLC.	Houston, TX	03/12/2021			
TDG General Contractors	Splendora, TX	03/12/2021			
TDT Plumbing (Texas Drain Technologies Inc)	Houston, TX	03/12/2021			
Teal Construction Company	Houston, TX	03/12/2021			
Techland Houston (Bright Star Productions Inc.)	Houston, TX	03/12/2021			
Teinert Commercial Building Services (Allen Teinert Construction)	Lubbock, TX	03/12/2021			
Tejas Electrical Services, Inc.	Spring, TX	03/12/2021			
Tellepsen Builders	Houston, TX	03/12/2021			
Telomack Cabling Solutions (Telomack Inc)	The Woodlands, TX	03/12/2021			
Texas	Austin, TX	03/12/2021			
Texas Association of African American Chambers of Commerce (TAAACC)	Austin, TX	03/12/2021			
Texas Best Window Cleaning (Leslie Martin)	Grand Prairie, TX	03/12/2021			
Texas Certified Roofing	Houston, TX	03/12/2021			
Texas Chiller Systems	San Antonio, TX	03/12/2021			
Texas Elite Electrical	Liberty, TX	03/12/2021			
Texas General Contractors, Inc.	Houston, TX	03/12/2021	Submitted	05/04/2021	05/04/2021
Texas Groundworks Management, Inc.	Houston, TX	03/12/2021			
Texas Home and Projects LLC	Brownsville, TX	03/12/2021			
Texas Metal Roundup	Alvin, TX	03/12/2021			
Texas Precision Paving	Houston, TX	03/12/2021	Viewed	05/04/2021	
Texas Steam & Instrumentation (Texas Steam Equipment Company, Inc.)	LA PORTE, TX	03/12/2021	Viewed	04/27/2021	
Texas Striping and Curb Appeal (Lamont Lagrone)	Houston, TX	03/12/2021			
Texas Tree Team (Intermodal Facility & Maintenance, Inc.)	Baytown, TX	03/12/2021			
TexLaCon Inc.	Houston, TX	03/12/2021			
TFC Contracting Solutions	Tomball, TX	03/12/2021			
TFC MECHANICAL (TFC Mechanical LLC)	WALLER, TX	03/12/2021			
The Baptiste Group LLC	Locust Grove, GA	03/12/2021			
The Bid Calendar	San Marcos, TX	03/12/2021			
The Blue Book Network (Contractors Register)	Jefferson Valley, NY	03/12/2021			
The Brandt Companies, LLC	Carrollton, TX	03/12/2021	Viewed	04/27/2021	
The Comfort King (Gideon Lynn LLC)	Conroe, TX	03/12/2021			
The Deck & Canopy Company LLC	Houston, TX	03/12/2021	Viewed	05/07/2021	
The Donatto Group	Houston, TX	03/12/2021			
THE E.T.H.E. GROUP	HOUSTON, TX	03/12/2021			
The Edu-Source Corporation	San Antonio, TX	03/12/2021	Viewed	05/03/2021	
THE FENCE LADY INC.	BOERNE, TX	03/12/2021			
The Filter Man LLC	New Caney, TX	03/12/2021			
The Gaia Group Inc.	Houston, TX	03/12/2021			

The Gonzalez Group, LP	Houston, TX	03/12/2021			
The Kovacs Group	New Braunfels, TX	03/12/2021			
The MarketinGroup, LLC	Kingwood, TX	03/12/2021			
The Mohawk Group	Marietta, GA	03/12/2021			
The Phoenix Group (Phoenix Contracting Group)	Houston, TX	03/12/2021			
The Ratliff Group, LLC	COPPELL, TX	03/12/2021			
The Remi Group	Charlotte, NC	03/12/2021			
The Reynolds Company	Houston, TX	03/12/2021			
The Safeguard System Inc. (Safeguard System Inc.)	Corpus Christi, TX	03/12/2021	No Bid	05/05/2021	05/05/2021
The Trevino Group, Inc.	Houston, TX	03/12/2021	Submitted	05/07/2021	05/07/2021
The United Construction co	Houston, TX, TX	03/12/2021			
the woodlands paints	magnolia, TX	03/12/2021			
Thermal-Chem Corporation (Armitages Industries, Inc.)	Franklin Park, IL	03/12/2021			
Third Coast Insulation Systems, LLC	Kingwood, TX	03/12/2021			
Thomas Printworks (Thomas Reprographics, Inc)	Houston, TX	03/12/2021			
Tico Telehealth Inc.	Austin, TX	03/12/2021			
TiCon Texas Construction Services	Houston, TX	03/12/2021			
TIGER RESTORATION AND REMODELING LLC	HOUSTON, TX	03/12/2021			
Timberline Homes Inc.	Birmingham, AL	03/12/2021			
TinMan Enterprises (TX TinMan Enterprises, LLC)	Fort Worth, TX	03/12/2021			
Tippet Construction, LLC	Baytown, TX	03/12/2021			
TLC Engineering, Inc.	Houston, TX	03/12/2021			
TMB Screen Printing & Embroidery Spring	Spring, TX	03/12/2021			
TMI Solutions, LLC	George West, TX	03/12/2021			
Tommy Klein Construction, Inc.	Lubbock, TX	03/12/2021			
Top Invest	Houston, TX	03/12/2021	Viewed	04/30/2021	
Topwater Construction Services LLC	Katy, TX	03/12/2021			
Total Boiler & Mechanical, LLC	Liverpool, TX	03/12/2021			
Total Lender Services LLC	Spring, TX	03/12/2021			
Total Team Companies, LLC	Houston, TX	03/12/2021			
Total Team Construction	HOUSTON, TX	03/12/2021			
TouchView Inc	Brockton, MA	03/12/2021			
TP&R CONSTRUCTION, L.L.C.	DESOTO, TX	03/12/2021			
Transcare llc	Houston, TX	03/12/2021			
Travis Cox Plumbing Company, LLC	Kyle, TX	03/12/2021			
Treco Services, Inc.	San Antonio, TX	03/12/2021			
Triad Commercial Real Estate Services (Triad Commercial services, Ltd.)	Dallas, TX	03/12/2021			
Trinity Roofing & Restoration (MCD Growth Services LLC)	SUGAR LAND, TX	03/12/2021			
Triple B Cleaning, Inc.	Queensbury, NY	03/12/2021			
Triple D Enterprises	Tomball, TX	03/12/2021			
Tri-Star Glass, Inc	Vidor, TX	03/12/2021			
TRW MODERNFOLD CO., INC.	HOUSTON, TX	03/12/2021			
TSG Industries (The Sithe Group, LLC.)	Houston, TX	03/12/2021			
Tucker Construction (Jon Tucker Construction, LTD)	Bryan, TX	03/12/2021			
Tucker Roofing Systems, LLC.	Rowlett, TX	03/12/2021			
Tulip Building	San Antonio, TX	03/12/2021			
Turner Power and Construction, LLC (Turner Power Systems and Concractors, LLC)	Houston, TX	03/12/2021			
TX Cleaning & Integral Solutions	Cedar Hill, TX	03/12/2021			
U. S. WHOLESALE PRODUCTS	SAN ANTONIO, TX	03/12/2021			
U.S Electronics recycling Center Inc (Isaac F Sunday)	Houston, TX	03/12/2021			
Ultimate Plumbing	Brownfield, TX	03/12/2021			
Unify Energy Solutions	Houston, TX	03/12/2021			
United CSH Services (United CSH Corporation)	HOUSTON, TX	03/12/2021			
United Restoration & Preservation, Inc	Houston, TX	03/12/2021			
UPKEEP PRESERVATION SERVICES LLC (MARIN)	HOUSTON, TX	03/12/2021			
URETEK ICR Gulf Coast (Urelift Gulf Coast, LP)	Houston, TX	03/12/2021			
Ursin's Energy Efficient Lighting,LLC.	Houston, TX	03/12/2021			
US Executive LLC	Tampa, FL	03/12/2021	Viewed	05/07/2021	
Utility Services Associates, LLC	Burien, WA	03/12/2021			

V V Construction, LLC.	Mansfield, TX	03/12/2021			
Vallelunga Enterprises LLC dba The Router Room,	Dallas, TX	03/12/2021			
Varsity Facility Services (Varsity Contractors)	Pocatello, ID	03/12/2021			
Vaughn Construction (J.T. Vaughn Construction, LLC)	Houston, TX	03/12/2021			
Venice Flooring and Remodeling	Houston, TX	03/12/2021			
Ventura Construction Inc.	Richardson, TX	03/12/2021			
Verdant Web Technologies Inc.	Bend, OR	03/12/2021			
Vertex Roofing, LLC	Corpus Christi, TX	03/12/2021			
Video Industrial Services, Inc.	Birmingham, AL	03/12/2021			
Virginia	Richmond, VA	03/12/2021			
Virtual Builders Exchange	San Antonio, TX	03/12/2021	Viewed	04/27/2021	
Virtus Group LLC	Olathe, KS	03/12/2021			
Vistex Graphics, LLC	Houston, TX	03/12/2021			
Voceon Digital Radio Communications	Houston, TX	03/12/2021			
Vortex Colorado	Irvine, CA	03/12/2021			
vscoatings llc	Humble, TX	03/12/2021			
W. A. Robbins Construction Co., Inc.	Houston, TX	03/12/2021	Viewed	05/07/2021	
W. B. Construction and Son's Inc.	Beaumont, TX	03/12/2021			
W.M. Jones Construction, Inc.	League City, TX	03/12/2021			
wagner interiors	San Antonio, TX	03/12/2021			
Washington	Olympia, WA	03/12/2021			
Waterman Construction	San Antonio, TX		Unsubmitted	05/06/2021	
Watkins & Associates Consulting Services LLC.	Houston, TX	03/12/2021			
Weatherproofing Services (Weatherproofing Service LLC)	Cross Roads, TX		Submitted	05/07/2021	05/07/2021
WeatherTech Roofing, LLC	San Antonio, TX	03/12/2021			
Webber Commercial Construction, LLC	The Woodlands, TX	03/12/2021			
West Virginia	Charleston, WV	03/12/2021			
Westco Ventures LLC	Houston, TX	03/12/2021			
Western Specialty Contractors (Western	St. Louis, MO	03/12/2021			
Waterproofing Company of America dba/ Western Specialty Contractors of America)					
Westwood Restoration, LLC	The Woodlands, TX	03/12/2021			
White Star Services, LLC	Corpus Christi, TX	03/12/2021	Viewed	04/29/2021	
Wild Magnolia Landscaping LLC	Crosby, TX	03/12/2021			
Williamson Restoration Inc (Williamson Services Inc)	Royse City, TX	03/12/2021			
Williamsville Resources Inc (Williamsville Resources II Inc)	Spring, TX	03/12/2021			
Window Systems of Texas Inc.	Houston, TX	03/12/2021			
Wisconsin	Madison, WI	03/12/2021			
Worldwide Power Products	Houston, TX	03/12/2021			
Wrench, Inc.	Seattle, WA	03/12/2021			
Wylie Construction Services	Humble, TX	03/12/2021	Submitted	05/07/2021	05/07/2021
XtraLight Manufacturing, Ltd.	Houston, TX	03/12/2021	Viewed	04/29/2021	
Yes America Enterprises (Yes America Now, Inc)	Stafford, TX	03/12/2021			
YR Testing Account	Everywhere, TX		Viewed	05/05/2021	
Yucca Contracting	El Paso, TX	03/12/2021			
Z FLOOR CO., LTD.	LAKE DALLAS, TX	03/12/2021			
Z Smart, LLC	Rockwall, TX	03/12/2021			
Zapata Janitorial Building & General Service, Inc.	Houston, TX	03/12/2021			

### External Invitations

Invite Email	Auto Approve	Invitation Date	Status	Status Date
dwright@wilsonunlimitedllc.com	No	03/12/2021	Invitation Sent	03/12/2021
jthigpen@basicidiq.com	No	03/12/2021	Invitation Sent	03/12/2021
jward@geimech.com	No	04/15/2021	Invitation Sent	04/15/2021
lauraalford@cfimech.com	No	04/15/2021	Invitation Sent	04/15/2021
rcavness@mooringusa.com	Yes	03/29/2021	Invitation Sent	03/29/2021
rosie@charliesplumbing.com	No	04/15/2021	Invitation Sent	04/15/2021
SKoch@mccarthy.com	No	04/16/2021	Invitation Sent	04/16/2021

### Participant Detail

048BRI (Dragon Limited Inc)

Address PO Box 11695 Participation Type: Active Supplier  
College Station, TX 77842

Classifications MBE,SBE (Primary)

Invitation Date 03/12/2021  
Invitation Type Automatic  
Invitation Email(s) 048bri@gmail.com

1st Materials Soil Stabilization (1st Materials & Technology, Inc.)

Address p.o.box 831 Participation Type: Active Supplier  
cameron, TX 76520

Classifications HUB,WBE (Primary)

Invitation Date 03/12/2021  
Invitation Type Automatic  
Invitation Email(s) alan@first-materials.com

210 Backflow

Address 505 E Langley Blvd Participation Type: Active Supplier  
Universal City, TX 78148

Classifications MBE (Primary),SBE,HUB,WBE

Response Status Viewed  
Status Date 05/01/2021

2K Design Services, LLC

Address 26029 Aldine Westfield Rd., Suite 201 Participation Type: Active Supplier  
Spring, TX 77373

Classifications SBE (Primary),HUB,WBE

Invitation Date 03/12/2021  
Invitation Type Automatic  
Invitation Email(s)

3 Concepts Contractors (Gillespie Capital Enterprises LLC)

Address 2505 Arshia St. Participation Type: Active Supplier  
Corpus Christi, TX 78414

Classifications MBE (Primary),SBE

Invitation Date 03/12/2021  
Invitation Type Automatic  
Invitation Email(s) kelin42240@hotmail.com

308 Construction, LLC

Address 2126 Hamilton Dr. Participation Type: Active Supplier  
Argyle, TX 76226

Invitation Date 03/12/2021  
Invitation Type Automatic  
Invitation Email(s) main@308gc.com

360TXC, LLC

Address 901 S.Mopac #300 Participation Type: Active Supplier  
Austin, TX 78701

Classifications MBE,SBE (Primary),HUB,WBE

Invitation Date 03/12/2021  
Invitation Type Automatic  
Invitation Email(s) tlester@360txc.com

365 Paving & Construction LLC

Address 1618 E. Griffin Parkway Participation Type: Active Supplier  
Mission, TX 78572

Invitation Date 03/12/2021  
Invitation Type Automatic  
Invitation Email(s) 365paving@gmail.com

3i Contracting LLC

Address 1111 W Mockingbird Lane, Ste 1050 Participation Type: Active Supplier  
DALLAS, TX 75247

Classifications MBE,SBE,HUB (Primary)

Invitation Date 03/12/2021  
Invitation Type Automatic  
Invitation Email(s) RTR1001@gmail.com jsmith@3icontracting.com

A & H Electric

Address 3505 N Loop 336 West Participation Type: Active Supplier  
Conroe, TX 77304

Invitation Date 03/12/2021  
Invitation Type Automatic  
Invitation Email(s) julieb@ahelectric.com dgaskins@ahelectric.com justinp@ahelectric.com jeffh@ahelectric.com  
brianw@ahelectric.com erinr@ahelectric.com

a & i custom manufacturing llc

Address 4337 Martinal Participation Type: Active Supplier  
brownsville, TX 78526

Classifications MBE (Primary),HUB,WBE

Invitation Date 03/12/2021  
Invitation Type Automatic  
Invitation Email(s) ismael.ai@hotmail.com

A Clearer Image

Address 205 Sheffield In Participation Type: Active Supplier  
YORKTOWN, VA 23693

Classifications SBE (Primary)

Invitation Date 03/12/2021  
Invitation Type Automatic  
Invitation Email(s) aci8430@gmail.com

A Light Construction

Address 17935 Brent Dr Participation Type: Active Supplier  
Dallas, TX 75287

Invitation Date 03/12/2021  
Invitation Type Automatic  
Invitation Email(s) alightconstruction@yahoo.com

A Status Construction LLC

Address 8951 Ruthby St Participation Type: Active Supplier  
Houston, TX 77061

Classifications MBE (Primary),SBE,HUB,WBE

Invitation Date 03/12/2021  
Invitation Type Automatic  
Invitation Email(s) rb@astatusconstruction.com

A&E Development

Address 4606 FM 1960 W, Ste 417  
Houston, TX 77024 Participation Type: Active Supplier

Classifications WBE (Primary)

Response Status Viewed  
Status Date 04/27/2021

A&L Sanchez Painting and Construction

Address 114 N 4th Street Ste A  
Killeen, TX 76541 Participation Type: Active Supplier

Classifications MBE,SBE (Primary),HUB,WBE

Invitation Date 03/12/2021  
Invitation Type Automatic  
Invitation Email(s) dalcozer@a-lsanchezpainting.com

A. Bargas & Associates, LLC

Address P.O. Box 792056  
San Antonio, TX 78279 Participation Type: Active Supplier

Classifications MBE,TAS,TIP,TXM,SBE  
(Primary),HUB,WBE

Invitation Date 03/12/2021  
Invitation Type Automatic  
Invitation Email(s) cbargas@abargasco.com

A.G.H. Environmental, Inc.

Address 13230 Gerngross Ln  
Houston, TX 77044 Participation Type: Active Supplier

Invitation Date 03/12/2021  
Invitation Type Automatic  
Invitation Email(s) sgreenaghenvironmental@yahoo.com

A.T. Kearney

Address 222 W Adams St  
Chicago, IL 60606 Participation Type: Active Supplier

Invitation Date 03/12/2021  
Invitation Type Automatic  
Invitation Email(s) alexander.schmidt@atkearney.com

AA Distribution inc

Address 88 Parkhurst st  
Newark, NJ 07114 Participation Type: Active Supplier

Invitation Date 03/12/2021  
Invitation Type Automatic  
Invitation Email(s) aali2580@yahoo.com

AAA Painting

Address 6005 Westview Rd.  
Houston, TX 77055 Participation Type: Active Supplier

Invitation Date 03/12/2021  
Invitation Type Automatic  
Invitation Email(s)

AAA Time Saver Services

Address 2002 W. Wildwood  
San Antonio, TX 78201 Participation Type: Active Supplier

Classifications MBE (Primary),TIP

Invitation Date 03/12/2021  
Invitation Type Automatic  
Invitation Email(s) timesavergroup@aol.com

AB Modern Houston LLC

Address 2800 Kirby Drive  
Houston, TX 77098 Participation Type: Active Supplier

Classifications SBE (Primary)

Invitation Date 03/12/2021  
Invitation Type Automatic  
Invitation Email(s)

ABBA Construction

Address 15502 Hwy 3  
Webster, TX 77598 Participation Type: Active Supplier

Invitation Date 03/12/2021  
Invitation Type Automatic  
Invitation Email(s) patty@abbaroofing.com

ABM Education

Address 2100 Kramer Lane  
Austin, TX 78758 Participation Type: Active Supplier

Classifications TAS (Primary),TCP

Invitation Date 03/12/2021  
Invitation Type Automatic  
Invitation Email(s) Ellen.Armstrong@abm.com Stephen.Ferrar@abm.com educationss@abm.com

ABM Underground Utility Const Company

Address 24418 chipwood  
Magnolia, TX 77355 Participation Type: Active Supplier

Classifications MBE,SBE (Primary)

Invitation Date 03/12/2021  
Invitation Type Automatic  
Invitation Email(s) ondwr4501@sbcglobal.net

ABS MULTI SERVICES (ABS JANITORIAL SERVICE, LLC)

Address 11034 DENNIS ROAD  
DALLAS, TX 75229 Participation Type: Active Supplier

Classifications MBE (Primary),SBE,WBE

Invitation Date 03/12/2021  
Invitation Type Automatic  
Invitation Email(s) sandraa@absmultiservice.com customerservice@absmultiservice.com

Absolute Waterproofing

Address 1000A Sidney Baker South  
Kerrville, TX 78028 Participation Type: Active Supplier

Invitation Date 03/12/2021  
Invitation Type Automatic  
Invitation Email(s) millercris@ktc.com

AC/DC Synergy Group

Address 623 S. Chestnut St  
Tomball, TX 77375 Participation Type: Active Supplier

Classifications WBE (Primary)

Invitation Date 03/12/2021  
Invitation Type Automatic  
Invitation Email(s) dennis.thomas@acdc-sg.com  
Response Status Viewed  
Status Date 04/28/2021

ACE FABRICATORS INC

Address 7010 Furay Rd  
Houston, TX 77016-1508 Participation Type: Active Supplier

Invitation Date 03/12/2021  
Invitation Type Automatic  
Invitation Email(s) bids@acefabricatorsinc.com

Acme Architectural Hardware

Address 1006 West 34th Street  
Houston, TX 77018 Participation Type: Active Supplier

Invitation Date 03/12/2021  
Invitation Type Automatic  
Invitation Email(s) bmidkiff@aahdw.com mgalindo@aahdw.com

Acme Fence Services Inc

Address 2509 Minnis Dr  
Haltom City, TX 76117 Participation Type: Active Supplier

Classifications WBE (Primary)

Invitation Date 03/12/2021  
Invitation Type Automatic  
Invitation Email(s) johndavis@acmefenceservices.net

ACTION RESTORATION, INC.

Address 2 HILL VIEW LANE  
BOERNE, TX 78006 Participation Type: Active Supplier

Classifications TIP,TXM,SBE,HUB,WBE (Primary)

Invitation Date 03/12/2021  
Invitation Type Automatic  
Invitation Email(s) cholzapfel@action-restoration.com

Acumen Enterprises, Inc.

Address 1504 Falcon  
Desoto, TX 75115 Participation Type: Active Supplier

Invitation Date 03/12/2021  
Invitation Type Automatic  
Invitation Email(s) wayne@acumen-enterprises.com

Adept Facilities & Design, Inc.

Address 3110 Lazy Lake Dr.  
Harlingen, TX 78550 Participation Type: Active Supplier

Classifications MBE, TIP, TXM, SBE (Primary), WBE

Invitation Date 03/12/2021  
Invitation Type Automatic  
Invitation Email(s) dsm.afd@gmail.com tsm.afd@gmail.com



ADG General Contractor & Construction (Affiliated Development Group LLC)

Address 1920 N. Coit Rd., Suite 200-220 Richardson, AL 75080 Participation Type: Active Supplier

Classifications MBE,SBE (Primary),HUB

Invitation Date 03/12/2021  
Invitation Type Automatic  
Invitation Email(s) nate.roberts@adg-builds.com

Advancetech Systems (Advancetech Systems 2, Inc.)

Address P.O. Box 771418 Houston, TX 77215 Participation Type: Active Supplier

Classifications MBE,DIR,SBE,HUB (Primary)

Invitation Date 03/12/2021  
Invitation Type Automatic  
Invitation Email(s) tgomes@advancetechsystems.com

AdvantaClean of San Antonio

Address 4700 West Timco Blvd Suite 119 San Antonio, TX 78238 Participation Type: Active Supplier

Invitation Date 03/12/2021  
Invitation Type Automatic  
Invitation Email(s) ken.sloan@advantaclean.com

Adventure Experiences, LLC

Address 517 Mallard Lane Trinity, TX 75862 Participation Type: Active Supplier

Classifications SBE (Primary)

Invitation Date 03/12/2021  
Invitation Type Automatic  
Invitation Email(s) aei@advexp.com

Advocate Solutions

Address 9506 N. Sam Houston Pkwy E. Humble, TX 77396 Participation Type: Active Supplier

Invitation Date 03/12/2021  
Invitation Type Automatic  
Invitation Email(s) kirkjvaughn@hotmail.com

AECOM (AECOM Technical Services Inc)

Address 19219 Katy Freeway. Ste 100 Houston, TX 77094 Participation Type: Active Supplier

Invitation Date 03/12/2021  
Invitation Type Automatic  
Invitation Email(s)

Aerodynamics Inspecting of Texas, LLC

Address PO Box 1888 San Juan, TX 78589 Participation Type: Active Supplier

Classifications MBE (Primary),SBE,HUB

Invitation Date 03/12/2021  
Invitation Type Automatic  
Invitation Email(s) aerodynamicctx@yahoo.com

AFD Services LLC

Address 9212 Fry Road  
Cypress, TX 77433 Participation Type: Active Supplier

Invitation Date 03/12/2021  
Invitation Type Automatic  
Invitation Email(s) info@afdsvcs.com

Aggieland Construction

Address PO Box 271  
Wellborn, TX 77881 Participation Type: Active Supplier

Classifications HUB

Invitation Date 03/12/2021  
Invitation Type Automatic  
Invitation Email(s) bids@aggielandconstruction.com  
Response Date 03/29/2021  
Response Status Submitted  
Status Date 03/29/2021

Aggreko

Address 3732 Magnolia  
Pearland, TX 77584 Participation Type: Active Supplier

Invitation Date 03/12/2021  
Invitation Type Automatic  
Invitation Email(s)

AGH2O Holdings, LLC

Address 3817 Bent Brook Drive  
Round Rock, TX 78664 Participation Type: Active Supplier

Invitation Date 03/12/2021  
Invitation Type Automatic  
Invitation Email(s) jlesko@austin.rr.com

Agile Environmental, LLC

Address 1504 Beaconshire Rd.  
Houston, TX 77077 Participation Type: Active Supplier

Invitation Date 03/12/2021  
Invitation Type Automatic  
Invitation Email(s) r.monfared@agileenvironmental.com  
Response Status Viewed  
Status Date 04/28/2021

Airwall Techs, LLC

Address PO Box 5581  
Pasadena, TX 77508 Participation Type: Active Supplier

Invitation Date 03/12/2021  
Invitation Type Automatic  
Invitation Email(s) anthony@airwalltechs.com

Alabama

Address P.O. Box 5690  
Montgomery, AL 36103 Participation Type: Active Supplier

Invitation Date 03/12/2021  
Invitation Type Manual  
Invitation Email(s)

Alegna Technologies, Inc.

Address 3700 Kennesaw S. Industrial Drive NW Participation Type: Active Supplier  
Kennesaw, GA 30144

Classifications MBE (Primary),SBE,WBE

Invitation Date 03/12/2021  
Invitation Type Automatic  
Invitation Email(s) ACabrera@AlegnaTechnologies.com  
Response Status Unsubmitted  
Status Date 05/08/2021

Alklean Industries, Inc

Address 2111 Catalina Drive Participation Type: Active Supplier  
Pasadena, TX 77503

Classifications MBE (Primary),SBE,WBE

Response Status Viewed  
Status Date 05/06/2021

ALL AMERICAN SPECIALTY CONSTRUCTION LLC

Address 1780 HURD DRIVE Participation Type: Active Supplier  
IRVING, TX 75038

Invitation Date 03/12/2021  
Invitation Type Automatic  
Invitation Email(s) mickeyaliff@gmail.com

All Around Construction Company, LLC

Address 1417 se 3001 Participation Type: Active Supplier  
Andrews, TX 79714

Classifications SBE (Primary),HUB,WBE

Invitation Date 03/12/2021  
Invitation Type Automatic  
Invitation Email(s) lynde@allaroundconstructioncompany.net

All Clean Services

Address 3707 Constitution Drive Participation Type: Active Supplier  
Grand Prairie, TX 75052

Classifications SBE (Primary)

Invitation Date 03/12/2021  
Invitation Type Automatic  
Invitation Email(s) dheeth@allcleansvcs.com

All Doors and More

Address 12784 county road 1320 Participation Type: Active Supplier  
Sinton, TX 78387

Classifications SBE (Primary)

Invitation Date 03/12/2021  
Invitation Type Automatic  
Invitation Email(s) msumma@twc.com

All Kinds Of Doors (lyoob)

Address 13714 Hempstead Rd Participation Type: Active Supplier  
Houston, TX 77040

Invitation Date 03/12/2021  
Invitation Type Automatic  
Invitation Email(s) info@allkinddoor.com

All Pro Commercial Services (APC Industries, LLC)

Address 7604 BAKER BLVD Participation Type: Active Supplier  
RICHLAND HILLS, TX 76118

Classifications SBE (Primary)

Invitation Date 03/12/2021  
Invitation Type Automatic  
Invitation Email(s) Pat@allprocstx.com

All Texas Electrical Contractors Inc.

Address 6016 Centralcrest St. Participation Type: Active Supplier  
Houston, TX 77092

Classifications MBE,SBE (Primary),HUB

Invitation Date 03/12/2021  
Invitation Type Automatic  
Invitation Email(s) bmontemayor@alltexaselectrical.net

All-Fair Electric, Inc

Address PO Box 137033 Participation Type: Active Supplier  
Fort Worth, TX 76136

Classifications SBE (Primary),HUB,WBE

Invitation Date 03/12/2021  
Invitation Type Automatic  
Invitation Email(s) Tracy@allfairelectric.com

Alliance Tank Service (ATS Group, LLC)

Address 613 N. Euclaw Valley Road Participation Type: Active Supplier  
Cushing, OK 74023

Invitation Date 03/12/2021  
Invitation Type Automatic  
Invitation Email(s) elakey@alliancetankservice.com

Allied electric Services Inc.

Address 4355 E. University Participation Type: Active Supplier  
Georgetown, TX 78626

Classifications HUB (Primary),WBE

Invitation Date 03/12/2021  
Invitation Type Automatic  
Invitation Email(s) james@alliedelectric.us

Allied Signs

Address 6820 Harwin Dr. Participation Type: Active Supplier  
Houston, TX 77036

Invitation Date 03/12/2021  
Invitation Type Automatic  
Invitation Email(s) alliedsigns1@gmail.com

All-Terra Engineering, Inc (All-Terra Materials Testing, Inc)

Address 6200 Rothway Participation Type: Active Supplier  
Houston, TX 77040

Invitation Date 03/12/2021  
Invitation Type Automatic  
Invitation Email(s)

Ally Roofing Services

Address 507 Rankin Circle North Participation Type: Active Supplier  
Houston, TX 77073

Classifications SBE (Primary),HUB

Invitation Date 03/12/2021  
Invitation Type Automatic  
Invitation Email(s) tchapman@allyroofingservices.com cinman@allyroofingservices.com

Alpha Building Corporation

Address 24850 Blanco Road Participation Type: Active Supplier  
San Antonio, TX 78260

Invitation Date 03/12/2021  
Invitation Type Automatic  
Invitation Email(s) RCrow@alphabuilding.com

Alpine Construction Company (Alpine Engineering & Construction, LLC)

Address 2821 JORDENS ROAD STE 100 Participation Type: Active Supplier  
Houston, TX 77084

Invitation Date 03/12/2021  
Invitation Type Automatic  
Invitation Email(s) mhayes@alpinecompany.us

Al-Raza Computing Services (Al-Razaq Computing Services)

Address 6001 Savoy Participation Type: Active Supplier  
Houston, TX, TX 77036

Classifications MBE,TXM,SBE,HUB (Primary)

Invitation Date 03/12/2021  
Invitation Type Automatic  
Invitation Email(s)

Altius Graphics (NAYAK Corporation)

Address 11205 Main St., Ste 118 Participation Type: Active Supplier  
Houston, TX 77025

Classifications MBE (Primary),SBE,HUB

Invitation Date 03/12/2021  
Invitation Type Automatic  
Invitation Email(s) siddhartha.nayak@altiusgraphics.com

Alvin Equipment Company

Address 3375 E Highway 6 Participation Type: Active Supplier  
Alvin, TX 77511

Invitation Date 03/12/2021  
Invitation Type Automatic  
Invitation Email(s) chris@alvinequipment.com

Alviso's Flash Cleaning

Address 2707 W Eighteenth St Participation Type: Active Supplier  
Irving, TX 75060

Classifications MBE (Primary)

Invitation Date 03/12/2021  
Invitation Type Automatic  
Invitation Email(s) alvisosflashcleaning@gmail.com

Ameresco, Inc.

Address 111 Speen Street Framingham, MA 01701 Participation Type: Active Supplier

Classifications TCP (Primary),TIP

Invitation Date 03/12/2021

Invitation Type Automatic

Invitation Email(s) grash@ameresco.com rgeorgeoff@ameresco.com sprice@ameresco.com vdrieling@ameresco.com  
wmccord@ameresco.com dallums@ameresco.com cnobles@ameresco.com

American Container Homes

Address 1575 East San Antonio Ave El Paso, TX 79901 Participation Type: Active Supplier

Invitation Date 03/12/2021

Invitation Type Automatic

Invitation Email(s) americancontainerhome@gmail.com

American Flag Pole

Address 26242 Hillman Highway Abingdon, VA 24210 Participation Type: Active Supplier

Invitation Date 03/12/2021

Invitation Type Automatic

Invitation Email(s) brad@hapco.com

AMERICAN FLOORING SERVICES

Address 310 Morton Street Suite 357 Richmond, TX 77469 Participation Type: Active Supplier

Invitation Date 03/12/2021

Invitation Type Automatic

Invitation Email(s) msmith7449@comcast.net

AMERICAN HVAC SERVICES, LLC

Address 25654 KIMRO RD HOCKELY, TX 77447 Participation Type: Active Supplier

Classifications MBE,SBE (Primary)

Invitation Date 03/12/2021

Invitation Type Automatic

Invitation Email(s) sherri@americanserv.com

American Restoration LLC

Address 2002 W. Kirby Wylie, TX 75098 Participation Type: Active Supplier

Invitation Date 03/12/2021

Invitation Type Automatic

Invitation Email(s)

American Roofing & Metal Co., Inc.

Address 801 Wyoming San Antonio, TX 78203 Participation Type: Active Supplier

Invitation Date 03/12/2021

Invitation Type Automatic

Invitation Email(s) john@amerroofing.com

American Technologies, Inc

---

Address 1004 N Ave  
Plano, TX 75054 Participation Type: Active Supplier

Invitation Date 03/12/2021  
Invitation Type Automatic  
Invitation Email(s) gsales@atirestoration.com

Amstar, Inc.

---

Address 1211 Pleasanton Road  
San Antonio, TX 78214 Participation Type: Active Supplier

Classifications MBE (Primary),SBE,HUB

Invitation Date 03/12/2021  
Invitation Type Automatic  
Invitation Email(s) atanacio@amstarincgc.com  
Response Status Viewed  
Status Date 05/07/2021

Andrew's Janitorial Service, Inc.

---

Address 5970 Mohican Dr.  
Manteca, CA 95336 Participation Type: Active Supplier

Invitation Date 03/12/2021  
Invitation Type Automatic  
Invitation Email(s)

Aogo Tech Services

---

Address 25643 Winford Estate Drive  
Richmond, TX 77406 Participation Type: Active Supplier

Invitation Date 03/12/2021  
Invitation Type Automatic  
Invitation Email(s) nihi.aogo@yahoo.com

Apache Services, Inc.

---

Address 301 N. Shaver St.  
Pasadena, TX 77506 Participation Type: Active Supplier

Invitation Date 03/12/2021  
Invitation Type Automatic  
Invitation Email(s) jgolden@apache-services.com

APEX Consulting group

---

Address 9894 Bissonnet Street suite 680  
Houston, TX 77036 Participation Type: Active Supplier

Classifications MBE,SBE (Primary),HUB

Invitation Date 03/12/2021  
Invitation Type Automatic  
Invitation Email(s) info@apexengroup.com

Aphid Maintenance Group

---

Address 1210 Diablo Dr  
Crosby, TX 77532 Participation Type: Active Supplier

Classifications MBE,SBE (Primary)

Invitation Date 03/12/2021  
Invitation Type Automatic  
Invitation Email(s) aphidmaintenancegroup@gmail.com

Aqua One LLC

Address 8145 Country Ln Participation Type: Active Supplier  
Nederland, TX 77627

Classifications HUB (Primary)

Invitation Date 04/05/2021  
Invitation Type Manual  
Invitation Email(s) krin@aquaonellc.com

AR Mechanical, L.L.C.

Address 307 Pennsylvania St Participation Type: Active Supplier  
South Houston, TX 77587

Classifications MBE,SBE (Primary)

Invitation Date 03/12/2021  
Invitation Type Automatic  
Invitation Email(s) armechanical1@yahoo.com

AR Turnkey Construction Company (Adam Turner)

Address P. O. Box 925985 Participation Type: Active Supplier  
Houston, TX 77292

Classifications SBE (Primary)

Invitation Date 03/12/2021  
Invitation Type Automatic  
Invitation Email(s) main@arturnkee.com

Aramark Management Services Limited Partnership (Aramark SMMS LLC)

Address 2400 Market Street Participation Type: Active Supplier  
Philadelphia, PA 19103

Invitation Date 03/12/2021  
Invitation Type Automatic  
Invitation Email(s) growth@aramark.com

ARC Abatement, Inc.

Address 6827 Signat Drive Participation Type: Active Supplier  
Houston, TX 77041

Invitation Date 03/12/2021  
Invitation Type Automatic  
Invitation Email(s) dondaniel@arcabatement.com rickrickels@arcabatement.com

Architectural Sales Inc

Address 25700 I-45 North Participation Type: Active Supplier  
The Woodlands, TX 77386

Invitation Date 03/12/2021  
Invitation Type Automatic  
Invitation Email(s)

ardurra group

Address 2032 buffalo terrace Participation Type: Active Supplier  
houston, TX 77019

Invitation Date 03/12/2021  
Invitation Type Automatic  
Invitation Email(s) canonico@ardurrargroup.com



ARG Capital LLC

Address 3363 McCue Rd #112 Participation Type: Active Supplier  
Houston, TX 77056

Invitation Date 03/12/2021  
Invitation Type Automatic  
Invitation Email(s) thomaskorstad@gmail.com

Aries Building Systems LLC

Address 12600 Featherwood Dr; STE 450 Participation Type: Active Supplier  
Houston, TX 77034

Classifications HGA

Invitation Date 03/12/2021  
Invitation Type Automatic  
Invitation Email(s) mlicciardo@ariesbuildings.com elyon@ariesbuildings.com

ARMKO Industries Inc

Address 2007 First View Participation Type: Active Supplier  
Leander, TX 78641

Invitation Date 03/12/2021  
Invitation Type Automatic  
Invitation Email(s) mperry@armko.com

Armor Construction

Address 11841 Emily Ct. Participation Type: Active Supplier  
El Paso, TX 79936

Classifications MBE (Primary),HUB

Invitation Date 03/12/2021  
Invitation Type Automatic  
Invitation Email(s) lorenzopena1024@gmail.com

Arrow Exterminators

Address 9000 Jameel Rd ste 100 Participation Type: Active Supplier  
Houston, TX 77040

Invitation Date 03/12/2021  
Invitation Type Automatic  
Invitation Email(s) rcoleman@arrowexterminators.com

ASA Builders, Inc

Address 2628 E Sam Pkwy S Participation Type: Active Supplier  
pasadena, TX 77503

Classifications SBE

Invitation Date 03/12/2021  
Invitation Type Automatic  
Invitation Email(s) huntingtexas@sbcglobal.net  
Response Date 05/04/2021  
Response Status Submitted  
Status Date 05/04/2021

ASAP Roofing (Koppel & Kozel, LLC)

Address 13026 Kallan Ave Participation Type: Active Supplier  
Tyler, TX 75703

Classifications SBE (Primary)

Invitation Date 03/12/2021  
Invitation Type Automatic  
Invitation Email(s) joseph@tylerroofingasap.com

Ascension Roofing and Construction, LLC

Address 2001 Karbach suite G Houston, TX 77092 Participation Type: Active Supplier

Classifications SBE (Primary)

Invitation Date 03/12/2021  
Invitation Type Automatic  
Invitation Email(s) Bryan@MyARC-LLC.com

ASD Consultants, Inc.

Address 8120 North IH 35 Austin, TX 78753 Participation Type: Active Supplier

Classifications MBE,SBE,HUB (Primary)

Invitation Date 03/12/2021  
Invitation Type Automatic  
Invitation Email(s) curtis2aia@gmail.com

ASG Energy, LLC

Address 9249 S Broadway Highlands Ranch, CO 80129 Participation Type: Active Supplier

Invitation Date 03/12/2021  
Invitation Type Automatic  
Invitation Email(s) dave.marsh@asgeneryllc.com

Associated Testing Laboratories, inc,

Address 3143 Yellowstone Blvd. houston, TX 77054 Participation Type: Active Supplier

Classifications MBE (Primary),SBE,HUB

Invitation Date 03/12/2021  
Invitation Type Automatic  
Invitation Email(s) priti@associatedtesting.com

Atkins Powerhouse Consulting LLC

Address 8020 Crimea Lane Fort Worth, TX 76123 Participation Type: Active Supplier

Classifications MBE (Primary),SBE,WBE

Invitation Date 03/12/2021  
Invitation Type Automatic  
Invitation Email(s) acgpowerhouse@gmail.com

Atlas Efficiency Solutions, LLC

Address 13284 Pond Springs Rd Austin, TX 78729 Participation Type: Active Supplier

Classifications SBE (Primary)

Invitation Date 03/12/2021  
Invitation Type Automatic  
Invitation Email(s) ty@atlas-e.com

Atlas Foundation Repair (Atlas Gulf Coast)

Address 8935 Solon Rd Houston, TX 77064 Participation Type: Active Supplier

Invitation Date 03/12/2021  
Invitation Type Automatic  
Invitation Email(s)

Atrium Roofing

Address 10615 Perrin Beitel Road, Participation Type: Active Supplier  
San Antonio, TX 78217

Invitation Date 03/12/2021  
Invitation Type Automatic  
Invitation Email(s) marissa@atriumroofing.com

ATViroTech Inc.

Address 1918 Mackenzie Way Participation Type: Active Supplier  
Missouri City, TX 77489

Classifications MBE (Primary),SBE,HUB

Invitation Date 03/12/2021  
Invitation Type Automatic  
Invitation Email(s) altownsend@atvirotech.com

ATW MGMT INC

Address 525 Northville Participation Type: Active Supplier  
Houston, TX 77037

Classifications MBE,SBE (Primary)

Invitation Date 03/12/2021  
Invitation Type Automatic  
Invitation Email(s) mishee@atwonline.net

AtWork Personnel Svices (Aceda Solutions)

Address 4544 Post Oak Place Drive Participation Type: Active Supplier  
Houston, TX 77027

Classifications MBE (Primary),SBE,WBE

Invitation Date 03/12/2021  
Invitation Type Automatic  
Invitation Email(s)

ATX Fence Supply

Address 17301 S IH 35 Frontage Rd #107 Participation Type: Active Supplier  
Buda, TX 78610

Invitation Date 03/12/2021  
Invitation Type Automatic  
Invitation Email(s)

Automated Energy Solutions (Troy Geyer)

Address 614 S Capital of Texas Hwy Participation Type: Active Supplier  
West Lake Hills, TX 78746-5204

Classifications MBE,SBE (Primary),HUB

Invitation Date 03/12/2021  
Invitation Type Automatic  
Invitation Email(s) troy@automatedenergysolutions.net

Aztec Facility Services, Inc.

Address 11000 S Wilcrest Drive Participation Type: Active Supplier  
Houston, TX 77099

Classifications MBE,HUB,WBE (Primary)

Invitation Date 03/12/2021  
Invitation Type Automatic  
Invitation Email(s)

AZTECA Designs, Inc.

Address 20956 Somerset Rd  
Somerset, TX 78069 Participation Type: Active Supplier

Classifications MBE,TAS,TXM,SBE (Primary),HUB,WBE

Invitation Date 03/12/2021  
Invitation Type Automatic  
Invitation Email(s) castellano@aztecadesigns.com  
Response Date 05/07/2021  
Response Status Submitted  
Status Date 05/07/2021

B & C CONSTRUCTORS, LP

Address 27835 FM 2978 Rd.  
Magnolia, TX 77354 Participation Type: Active Supplier

Classifications SBE (Primary)

Invitation Date 03/12/2021  
Invitation Type Automatic  
Invitation Email(s) charles@bcconstructors.com paul@bcconstructors.com

B. D. & W. Const.

Address 606 Ave of Oaks  
Houston, TX 77009-1951 Participation Type: Active Supplier

Invitation Date 03/12/2021  
Invitation Type Automatic  
Invitation Email(s) jbdvmstr@aol.com

Bakers Signs and Lighting

Address 11201 Fm 1485  
Conroe, TX 77306 Participation Type: Active Supplier

Invitation Date 03/12/2021  
Invitation Type Automatic  
Invitation Email(s) andrea@bakerssigns.com

Baldwin Cleaning Services

Address 2003 Wedgewood Place  
Waldorf, MD 20602 Participation Type: Active Supplier

Invitation Date 03/12/2021  
Invitation Type Automatic  
Invitation Email(s) dontel.baldwin@gmail.com

Barnett AC Home Repair And Commercial Services LLC

Address 21415 Brighton Hollow Lane  
Katy, TX 77449 Participation Type: Active Supplier

Classifications HUB (Primary)

Invitation Date 03/12/2021  
Invitation Type Automatic  
Invitation Email(s) barnethomerepair@aol.com

Barstone, Inc.

Address 8000 W Interstate 10 Ste 681  
San Antonio, TX 78230 Participation Type: Active Supplier

Classifications MBE (Primary),SBE

Invitation Date 03/12/2021  
Invitation Type Automatic  
Invitation Email(s) admin@barstonecompany.com

BaseLine Paving & Construction, Inc.

Address P.O. Box 1606 Participation Type: Active Supplier  
Magnolia, TX 77353-1606

Classifications SBE (Primary),HUB,WBE

Invitation Date 03/12/2021  
Invitation Type Automatic  
Invitation Email(s) Baselineinc@msn.com danny@baselineconstruction.com

Basic IDIQ

Address 3403 73rd Street Participation Type: Active Supplier  
Lubbock, TX 79423

Invitation Date 03/12/2021  
Invitation Type Automatic  
Invitation Email(s) bmoczygemba@basicidiq.com bwilson@basicidiq.com  
Response Status Unsubmitted  
Status Date 03/18/2021

Basic SDV, Inc.

Address 10713 FM 620 North, Suite F-622 Participation Type: Active Supplier  
Austin, TX 78726

Classifications SBE (Primary),HUB

Invitation Date 03/12/2021  
Invitation Type Automatic  
Invitation Email(s) jdavis@basicsdv.com  
Response Date 05/07/2021  
Response Status Submitted  
Status Date 05/07/2021

Bass Constuction Co., Inc.

Address 1124 Damon St Participation Type: Active Supplier  
Rosenberg, TX 77471

Classifications SBE (Primary)

Invitation Date 03/12/2021  
Invitation Type Automatic  
Invitation Email(s) buck.bass@bassconstruction.com

Bath Fitter

Address 5911 Rittiman Plaza #2 Participation Type: Active Supplier  
San Antonio, TN 78218

Invitation Date 03/12/2021  
Invitation Type Automatic  
Invitation Email(s) wnewberry@bathfitter.com

Batterson, LLP

Address 6800 Dixie Dr Participation Type: Active Supplier  
Houston, TX 77087

Classifications SBE (Primary)

Invitation Date 03/12/2021  
Invitation Type Automatic  
Invitation Email(s) david@batterson.com

Battleground WTS

---

Address 815 Arlington Street Participation Type: Active Supplier  
Houston, TX 77007

Invitation Date 03/12/2021  
Invitation Type Automatic  
Invitation Email(s) doug.moore@battlegroundwts.com

Bauer Sport Floors, Inc.

---

Address PO Box 41858 Participation Type: Active Supplier  
Houston, TX 77241

Classifications TAS (Primary),TIP

Invitation Date 03/12/2021  
Invitation Type Automatic  
Invitation Email(s) rebecca@bauerfloor.com

BAXTER CLEANCARE (John M. Baxter Sales Co.)

---

Address 114 E. Niblick St Participation Type: Active Supplier  
Longview, TX 75604

Classifications TAS (Primary),TIP

Invitation Date 03/12/2021  
Invitation Type Automatic  
Invitation Email(s)

Baywood Exterminating Co

---

Address 5910 FM 2100 Participation Type: Active Supplier  
Crosby, TX 77532

Invitation Date 03/12/2021  
Invitation Type Automatic  
Invitation Email(s) baywoodext@att.net

BC Commercial (Beach Construction, Inc.)

---

Address 19220 Space Center Blvd Participation Type: Active Supplier  
Houston, TX 77058

Invitation Date 03/12/2021  
Invitation Type Automatic  
Invitation Email(s)

BCS A-1 Professional Cleaning

---

Address 3900 State Highway 6 South Suite 108 Participation Type: Active Supplier  
College Station, TX 77845

Classifications WBE (Primary)

Invitation Date 03/12/2021  
Invitation Type Automatic  
Invitation Email(s) helen@a1professionalcleaning.net

BD Modular Sales and Leasing

---

Address PO Box 601062 Participation Type: Active Supplier  
Dallas, TX 75360

Classifications SBE (Primary)

Invitation Date 03/12/2021  
Invitation Type Automatic  
Invitation Email(s) bsulton@bdmodular.com

BDK And Associates LLC

Address 210 Cheek Sparger Rd Participation Type: Active Supplier  
Colleyville, TX 76034

Invitation Date 03/12/2021  
Invitation Type Automatic  
Invitation Email(s)

BE Staffing Solutions LLC

Address 507 N. Sam Houston Pkwy E. Participation Type: Active Supplier  
Houston, TX 77060

Invitation Date 03/12/2021  
Invitation Type Automatic  
Invitation Email(s) Brittany@bestaffingsolutions.net

BE&K Building Group, LLC

Address 4545 Post Oak Place Dr Participation Type: Active Supplier  
Houston, TX 77095

Invitation Date 03/12/2021  
Invitation Type Automatic  
Invitation Email(s) jessica.mcknight@bekbg.com

BEASLEY TIRE SERVICE, INC

Address 11802 EASTEX FRWY Participation Type: Active Supplier  
HOUSTON, TX 77039

Classifications TXM (Primary)

Invitation Date 03/12/2021  
Invitation Type Automatic  
Invitation Email(s) bdauidson@beasleytire.com

Bedrock International Group, LLC

Address 14781 Memorial Drive, Suite 35 Participation Type: Active Supplier  
Houston, TX 77079

Invitation Date 03/12/2021  
Invitation Type Automatic  
Invitation Email(s) iqamar@bedrockgroupllc.com

BEK Co.

Address 923 Pine Meadow dr. Participation Type: Active Supplier  
Missouri City, TX 77489

Invitation Date 03/12/2021  
Invitation Type Automatic  
Invitation Email(s) bekcotx@gmail.com

Belfor Property Restoration (BELFOR USA Group, Inc.)

Address 11830 Radium St Participation Type: Active Supplier  
San Antonio, TX 78216-2711

Classifications SBE (Primary),WBE

Invitation Date 03/12/2021  
Invitation Type Automatic  
Invitation Email(s) tammy.kleine@us.belfor.com gary.alexander@us.belfor.com

Belknap Concrete

Address 9030 Solon Rd. Participation Type: Active Supplier  
Houston, TX 77064

Invitation Date 03/12/2021  
Invitation Type Automatic  
Invitation Email(s) estimating@belknapconcrete.com

Belknap Plumbing Systems, Inc.

Address 9030 Solon Rd. Participation Type: Active Supplier  
Houtson, TX 77066

Invitation Date 03/12/2021  
Invitation Type Automatic  
Invitation Email(s) estimating@belknapplumbing.com

BenchMark Facility Solutions, LLC

Address 5050 Quorum Drive, Suite 700, #147 Participation Type: Active Supplier  
Dallas, TX 75254-1410

Classifications SBE (Primary)

Invitation Date 03/12/2021  
Invitation Type Automatic  
Invitation Email(s) brian.jones@bfsmanagement.com

Benco Commercial Roofing (Benco Construcion Services Inc)

Address 10101 Hicks Field road Participation Type: Active Supplier  
fort worth, TX 76179

Classifications MBE (Primary),TAS,HUB

Invitation Date 03/12/2021  
Invitation Type Automatic  
Invitation Email(s) bert@benco-rfg.com

Bernhard (Bernhard MCC LLC)

Address 4888 Loop Central Drive Participation Type: Active Supplier  
Houston, TX 77081

Invitation Date 03/12/2021  
Invitation Type Automatic  
Invitation Email(s) rbalentine@bernhardmcc.com

Best Green Cleaning

Address 9494 Southwest Fwy. Ste. 450-E Participation Type: Active Supplier  
Houston, TX 77074

Classifications USC (Primary),SBE

Invitation Date 03/12/2021  
Invitation Type Automatic  
Invitation Email(s) bestgreencleaningtx@gmail.com

Big Art Co.

Address 9217 Jamaica Beach Participation Type: Active Supplier  
Galveston, TX 77554

Classifications WBE (Primary)

Invitation Date 03/12/2021  
Invitation Type Automatic  
Invitation Email(s) bigartco@aol.com

Big Bear Roofing & Construction

Address 910 North Avenue G Participation Type: Active Supplier  
Clifton, TX 76634

Invitation Date 03/12/2021  
Invitation Type Automatic  
Invitation Email(s) craig.tindle@bigbearroof.com



Blackland Glass & Construction

Address 120 Taylor Plaza Drive Participation Type: Active Supplier  
Greenville, TX 75402

Invitation Date 03/12/2021  
Invitation Type Automatic  
Invitation Email(s) billy@blacklandglass.com

Blackmon Mooring of Texas

Address 5718 Airport Freeway Participation Type: Active Supplier  
Haltom City, TX 76117

Invitation Date 03/12/2021  
Invitation Type Automatic  
Invitation Email(s) cablackmon@bmsmanagement.com mmosher@bmsmanagement.com mschultz@bmsmanagement.com  
lchilds@bmscat.com nestes@bmsmanagement.com

BLS Construction, Inc.

Address 207 Farenthold St Participation Type: Active Supplier  
El Campo, TX 77437

Classifications WBE (Primary)

Invitation Date 03/12/2021  
Invitation Type Automatic  
Invitation Email(s)

Blue Heron Construction Services, LLC

Address 10639 Clodine Road Participation Type: Active Supplier  
Richmond, TX 77407

Classifications MBE (Primary),SBE

Invitation Date 03/12/2021  
Invitation Type Automatic  
Invitation Email(s) pgarza@blueherontx.com

Blue Ox Construction, Inc

Address 3710 Lake Falls Drive Participation Type: Active Supplier  
Fulshear, TX 77441

Classifications SBE,HUB

Invitation Date 03/12/2021  
Invitation Type Automatic  
Invitation Email(s) jmarcano@blueoxconstruction.net  
Response Date 04/23/2021  
Response Status Submitted  
Status Date 04/23/2021

BluGreen Pest Control

Address PO Box 632 Participation Type: Active Supplier  
Wallis, TX 77485

Invitation Date 03/12/2021  
Invitation Type Automatic  
Invitation Email(s) cdrymala@live.com

BMS CONSTRUCTION

Address 2601 DEATS RD. Participation Type: Active Supplier  
DICKINSON, TX 77539

Invitation Date 03/12/2021  
Invitation Type Automatic  
Invitation Email(s)

Bond Restoration Inc

Address 4808 Gibson  
Houston, TX 77007 Participation Type: Active Supplier

Invitation Date 03/12/2021  
Invitation Type Automatic  
Invitation Email(s) avi@urbanmeridian.com

Boyd's Window Cleaning

Address 20907 Southvine  
Houston, TX 77073 Participation Type: Active Supplier

Classifications MBE (Primary),SBE

Invitation Date 03/12/2021  
Invitation Type Automatic  
Invitation Email(s) boydswindowcleaning@gmail.com

Boyer, Inc.

Address 8904 Fairbanks N. Houston Rd.  
Houston, TX 77064 Participation Type: Active Supplier

Invitation Date 03/12/2021  
Invitation Type Automatic  
Invitation Email(s) wguerra@boyerinc.com hgentry@boyerinc.com

Bradlink LLC

Address 4501 Magnolia Cove Drive  
Kingwood, TX 77345 Participation Type: Active Supplier

Classifications MBE,SBE (Primary),HUB,WBE

Invitation Date 03/12/2021  
Invitation Type Automatic  
Invitation Email(s) helen@bradlinkllc.com

Braun & Butler Construction

Address 715 Discovery Blvd. Suite 109  
Cedar Park, TX 78613 Participation Type: Active Supplier

Invitation Date 03/12/2021  
Invitation Type Automatic  
Invitation Email(s) estimating@braun-butler.com

Brazos - Valley Division, LLC.

Address 1903 Ray Shell Court  
Seabrook, TX 77586 Participation Type: Active Supplier

Classifications SBE (Primary)

Invitation Date 03/12/2021  
Invitation Type Automatic  
Invitation Email(s) d.galloway@brazos-industries.com  
Response Date 03/25/2021  
Response Status Submitted  
Status Date 03/25/2021

Brazos Urethane, Inc.

Address 1031 6th Street North  
Texas City, TX 77590 Participation Type: Active Supplier

Classifications TIP (Primary)

Invitation Date 03/12/2021  
Invitation Type Automatic  
Invitation Email(s) b.scoggins@brazosurethane.com

Brazos Valley Contractors Assoc

Address 4015 S Texas Ave  
BRYAN, TX 77802 Participation Type: Active Supplier

Invitation Date 03/12/2021  
Invitation Type Automatic  
Invitation Email(s) bvcaplanroom@gmail.com

Brian Duffy and Associates

Address 2014 Cartwright St  
Irving, TX 75062 Participation Type: Active Supplier

Classifications SBE (Primary)

Invitation Date 03/12/2021  
Invitation Type Automatic  
Invitation Email(s) brian@brianduffyandassocaites.com

Briar Patch

Address 12283-A Veterans Memorial Dr.  
Houston, TX 77067 Participation Type: Active Supplier

Classifications MBE (Primary),SBE,WBE

Invitation Date 03/12/2021  
Invitation Type Automatic  
Invitation Email(s) tpenonwilson@yahoo.com

BridgeNet Communications, LLC

Address 1314 Stites Road  
Donna, TX 78537 Participation Type: Active Supplier

Classifications MBE,HUB (Primary)

Invitation Date 03/12/2021  
Invitation Type Automatic  
Invitation Email(s) roxann@bncrgv.com

Bright Side Construction and Pressure Washing

Address 222 East 37th Streeth  
Houston, TX 77018 Participation Type: Active Supplier

Classifications MBE (Primary),HUB

Invitation Date 03/12/2021  
Invitation Type Automatic  
Invitation Email(s) brightsidepw@yahoo.com

Britain Electric

Address 1640 Brittmoore  
Houston, TX 77043 Participation Type: Active Supplier

Invitation Date 03/12/2021  
Invitation Type Automatic  
Invitation Email(s) Miket@Britainelectric.com

Broadcast Technical Services, Inc.

Address PO Box 40187  
Houston, TX 77240-0187 Participation Type: Active Supplier

Invitation Date 03/12/2021  
Invitation Type Automatic  
Invitation Email(s)

Broome Welding & Machine CO., Inc

Address 7909 Bayside Ave Participation Type: Active Supplier  
Galveston, TX 77554

Invitation Date 03/12/2021  
Invitation Type Automatic  
Invitation Email(s) crupert@broomewelding.com

Brown and Root Industrial Services, LLC

Address 2451 Crystal Drive Participation Type: Active Supplier  
Arlington, VA 22202

Classifications TCP (Primary),TXM

Invitation Date 03/12/2021  
Invitation Type Automatic  
Invitation Email(s) mike.martin@brownandroot.com mike.coberley@brownandroot.com  
Response Date 05/07/2021  
Response Status Submitted  
Status Date 05/07/2021

Brush Effects Inc. (Terry Mallory)

Address 1025 Holly Street Participation Type: Active Supplier  
La Marque, TX 77568

Classifications SBE (Primary)

Invitation Date 03/12/2021  
Invitation Type Automatic  
Invitation Email(s)

BryMak & Associates Inc

Address 1001 Progress Drive Participation Type: Active Supplier  
Clarksville, TN 37040

Classifications SBE (Primary)

Invitation Date 03/12/2021  
Invitation Type Automatic  
Invitation Email(s) mitch.farnham@brymak.com

BSA Design Group Inc.

Address 8750 N. Central Expressway, Suite 1725 Participation Type: Active Supplier  
Dallas, TX 75231

Classifications HUB (Primary),WBE

Invitation Date 03/12/2021  
Invitation Type Automatic  
Invitation Email(s) vwittliff@bsa-designgroup.com

Building Air Quality (BAQ Incorporated)

Address 29 Pinewood Forest Ct. Participation Type: Active Supplier  
The Woodlands, TX 77381

Classifications SBE (Primary)

Invitation Date 03/12/2021  
Invitation Type Automatic  
Invitation Email(s) IEQpro@Gmail.com

Building Solutions

Address 9401 LBJ Freeway  
dallas, TX 75243 Participation Type: Active Supplier

Invitation Date 03/12/2021  
Invitation Type Automatic  
Invitation Email(s) wdillard@buildingsolns.com

Building Tech Team, LLC

Address 16061 Moore Rd  
Von Ormy, TX 78073 Participation Type: Active Supplier

Invitation Date 03/12/2021  
Invitation Type Automatic  
Invitation Email(s) shaneb@buildingtechteam.com

Bunky and Son Construction, LLC

Address 2605 West Dumble Street  
Alvin, TX 77511 Participation Type: Active Supplier

Invitation Date 03/12/2021  
Invitation Type Automatic  
Invitation Email(s) bunkyandson@gmail.com

Business Flooring Partners, LLC

Address 7222 Ertel Lane  
Houston, TX 77040 Participation Type: Active Supplier

Classifications TXM,HUB (Primary)

Invitation Date 03/12/2021  
Invitation Type Automatic  
Invitation Email(s) austinbennett@bfsflooring.com rickgoolsby@bfsflooring.com stevebernish@bfsflooring.com  
shanegorrell@bfsflooring.com scotevans@bfsflooring.com

BWI Companies, Inc.

Address 21506 Highway 79 E  
Jacksonville, TX 75766 Participation Type: Active Supplier

Invitation Date 03/12/2021  
Invitation Type Automatic  
Invitation Email(s) claywilkerson@bwicompanies.com

C&B ELECTRIC & A/C SERVICES

Address 2616 Helena Ave  
McAllen, TX 78503 Participation Type: Active Supplier

Classifications MBE (Primary),SBE

Invitation Date 03/12/2021  
Invitation Type Automatic  
Invitation Email(s)

C&L Consulting

Address 3514 Wentworth Street  
Houston, TX 77004 Participation Type: Active Supplier

Classifications MBE (Primary),SBE,HUB,WBE

Invitation Date 03/12/2021  
Invitation Type Automatic  
Invitation Email(s)

C. F. McDonald Electric, Inc.

---

Address 5044 Timber Creek  
Houston, TX 77017 Participation Type: Active Supplier

Invitation Date 03/12/2021  
Invitation Type Automatic  
Invitation Email(s) roland@mcdonaldinc.com

C1S Group, Inc.

---

Address 4231 Sigma Road, Suite 110  
Dallas, TX 75244 Participation Type: Active Supplier

Invitation Date 03/12/2021  
Invitation Type Automatic  
Invitation Email(s) ashleigh.jones@c1sinc.com

Cable Construction Company (Joe Tom Cable)

---

Address 710 North 6th Street  
Sanger, TX 76266 Participation Type: Active Supplier

Classifications SBE (Primary)

Invitation Date 03/12/2021  
Invitation Type Automatic  
Invitation Email(s) Dave.hughes1016@gmail.com joetcable@yahoo.com

CAESAR CONSTRUCTION INC

---

Address 7526 WOVENWOOD LN  
HOUSTON, TX 77041 Participation Type: Active Supplier

Classifications MBE (Primary),SBE

Invitation Date 03/12/2021  
Invitation Type Automatic  
Invitation Email(s) caesarconstructioninc@gmail.com

Calico Construction and Development LLC

---

Address 1242 E Bus Highway 83 suite 7  
Mission, TX 78572 Participation Type: Active Supplier

Invitation Date 03/12/2021  
Invitation Type Automatic  
Invitation Email(s) Calico2019@yahoo.com

California

---

Address 707 3rd Street  
West Sacramento, CA 95605 Participation Type: Active Supplier

Invitation Date 03/12/2021  
Invitation Type Manual  
Invitation Email(s)

Cantex Roofing & Construction

---

Address 12108 E Hwy 62  
Idalou, TX 79329 Participation Type: Active Supplier

Invitation Date 03/12/2021  
Invitation Type Automatic  
Invitation Email(s) mike@cantexroofing.com  
Response Date 05/04/2021  
Response Status Submitted  
Status Date 05/04/2021

Caprock Electric

Address 900 Hogan  
Houston, TX 77009 Participation Type: Active Supplier

Classifications SBE,HUB,WBE (Primary)

Invitation Date 03/12/2021  
Invitation Type Automatic  
Invitation Email(s) joshlovoi@caprockelectric.com  
Response Status Viewed  
Status Date 04/27/2021

Carlos Rodriguez

Address 1935 Rock Ridge Dr.  
Houston, TX 77049 Participation Type: Active Supplier

Classifications MBE (Primary)

Invitation Date 03/12/2021  
Invitation Type Automatic  
Invitation Email(s) rodriguez122141@yahoo.com

CARPET 911 CLEANING & RESTORATION

Address 3056 LUXAR WAY  
DALLAS, TX 75233 Participation Type: Active Supplier

Classifications MBE (Primary),SBE,HUB

Invitation Date 03/12/2021  
Invitation Type Automatic  
Invitation Email(s) info@callcarpet911.com

Castro Roofing of Texas, L.P.

Address 4854 Olson Drive  
Dallas, TX 75227 Participation Type: Active Supplier

Classifications MBE (Primary),TIP,HUB

Invitation Date 03/12/2021  
Invitation Type Automatic  
Invitation Email(s) aj@castroroofing.com

Cavalry Construction

Address 3690 Highpoint St  
San Antonio, TX 78217 Participation Type: Active Supplier

Invitation Date 03/12/2021  
Invitation Type Automatic  
Invitation Email(s) lfilipowicz@cavalryconstruction.com

CBRE | Heery (CBRE Heery, Inc.)

Address 2800 Post Oak Blvd.  
Houston, TX 77056 Participation Type: Active Supplier

Invitation Date 03/12/2021  
Invitation Type Automatic  
Invitation Email(s) gary.whittle@cbre.com

CDJ JONES LLC (Cubes Office Services)

Address 6201 Bonhomme Ste 450-S  
Houston, TX 77036 Participation Type: Active Supplier

Classifications HUB (Primary)

Invitation Date 03/12/2021  
Invitation Type Automatic  
Invitation Email(s) AngelaH@CubesOfficeServices.com

CDM Contracting Services

Address 175 Duncan Road  
Brownsville, TX 78526 Participation Type: Active Supplier

Invitation Date 03/12/2021  
Invitation Type Automatic  
Invitation Email(s) cdm174@sbcglobal.net

CEC Facilities Group

Address 1275 Valley View LN  
Irving, TX 75061 Participation Type: Active Supplier

Invitation Date 03/12/2021  
Invitation Type Automatic  
Invitation Email(s) kkinchen@cecfg.com

Ceilpro

Address P.O. Box 8689  
Lumberton, TX 77657 Participation Type: Active Supplier

Invitation Date 03/12/2021  
Invitation Type Automatic  
Invitation Email(s) ceilpro@sbcglobal.net

Centennial Contractors Enterprises, Inc.

Address 1235 North Loop West  
Houston, LA 77008 Participation Type: Active Supplier

Invitation Date 03/12/2021  
Invitation Type Automatic  
Invitation Email(s) debra@cce-inc.com

Centennial Moisture Control, Inc.

Address 1780 Hurd Drive  
Irving, TX 75038 Participation Type: Active Supplier

Classifications SBE (Primary)

Invitation Date 03/12/2021  
Invitation Type Automatic  
Invitation Email(s) EDTCMC@gmail.com

Centex Construction

Address P.O. Box 102  
Temple, TX 76503 Participation Type: Active Supplier

Classifications MBE,TAS,SBE (Primary),WBE

Invitation Date 03/12/2021  
Invitation Type Automatic  
Invitation Email(s)

Century Weatherproofing INC

Address P.O. Box 1735  
Bowie, TX 76230 Participation Type: Active Supplier

Invitation Date 03/12/2021  
Invitation Type Automatic  
Invitation Email(s) carl.gresham@centurywpinc.com

Cettasale, Inc.

Address 4729 Feltleaf Ave.  
Crowley, TX 76063 Participation Type: Active Supplier

Invitation Date 03/12/2021  
Invitation Type Automatic  
Invitation Email(s) jwilboniii78@gmail.com



CFI Mechanical, Inc.

Address 6109 Brittmoores Road Participation Type: Active Supplier  
Houston, TX 77041

Invitation Date 03/12/2021

Invitation Type Automatic

Invitation Email(s) mattsolomon@cfimechanical.com artfilkins@cfimechanical.com lauraalford@cfimechanical.com  
roycizmar@cfimechanical.com garrettrobertson@cfimechanical.com

CFW ENTERPRISES LLC

Address 1688 S. Uvalda St. Participation Type: Active Supplier  
Aurora, CO 80012

Classifications MBE (Primary),SBE,WBE

Invitation Date 03/12/2021

Invitation Type Automatic

Invitation Email(s) michael@cfwstaffing.com

CGI Texas (Concrete Gel Injections Texas, Inc.)

Address 2010 Copper St. Participation Type: Active Supplier  
Garland, TX 75042

Classifications SBE (Primary)

Invitation Date 03/12/2021

Invitation Type Automatic

Invitation Email(s) marshall@cgitexas.com

CHAMPSCO, INC.

Address P.O. BOX 6718 Participation Type: Active Supplier  
Bryan, TX 77805

Invitation Date 03/12/2021

Invitation Type Automatic

Invitation Email(s) ronnie@champco.net

CHAMPION AWARDS

Address 2627 N Texas Blvd Participation Type: Active Supplier  
Weslaco, TX 78599

Classifications HUB (Primary)

Response Date 04/13/2021

Response Status No Bid

Status Date 04/13/2021

Chase in Dreams, Speech and Drama (Deadra Chase)

Address 14127 Pinewest Participation Type: Active Supplier  
Houston, TX 77049

Invitation Date 03/12/2021

Invitation Type Automatic

Invitation Email(s) chasemsD@yahoo.com

Chavez Service Companies, Inc. (.)

Address P. O. Box 572351 Participation Type: Active Supplier  
Houston, TX 77257

Invitation Date 03/12/2021

Invitation Type Automatic

Invitation Email(s) bchavez@chavezcompanies.com

Cherry House Moving

Address 9235 Edgebrook  
Houston, TX 77075 Participation Type: Active Supplier

Invitation Date 03/12/2021  
Invitation Type Automatic  
Invitation Email(s) cherryhousemoving@yahoo.com

Child Care Associates

Address 3000 E BELKNAP ST  
FORT WORTH, TX 76111-4142 Participation Type: Active Supplier

Invitation Date 03/12/2021  
Invitation Type Automatic  
Invitation Email(s) candace.lord@childcareassociates.org patricia.looper@childcareassociates.org

Chiron Communicaiton Services, LLC

Address 13827 Caven Street  
Humble, TX 77396 Participation Type: Active Supplier

Invitation Date 03/12/2021  
Invitation Type Automatic  
Invitation Email(s) rebecca@chironcomm.com courtneym@chironcomm.com ron@chironcomm.com mattb@chironcomm.com  
jeff@chironcomm.com rey@chironcomm.com  
Response Status Viewed  
Status Date 04/27/2021

CiVolt Services, LLC

Address 20633 Lenen Dr  
Hockley, TX 77447 Participation Type: Active Supplier

Classifications SBE (Primary),WBE

Invitation Date 03/12/2021  
Invitation Type Automatic  
Invitation Email(s) contact@civoltservices.com

Classic Protection Systems, Inc.

Address 1648 W Sam Hou Pkwy North  
Houston, TX 77043 Participation Type: Active Supplier

Invitation Date 03/12/2021  
Invitation Type Automatic  
Invitation Email(s) pros@classicprotectionsys.com

Clayton Total Gym

Address 177 Firetower Lane  
Rusk, TX 75785 Participation Type: Active Supplier

Classifications SBE (Primary)

Invitation Date 03/12/2021  
Invitation Type Automatic  
Invitation Email(s) sales@claytontotalgym.com

Clean and Green Solutions (EGR Exterior Services, LLC)

Address 22234 E Knox Dr  
Porter, TX 77365 Participation Type: Active Supplier

Invitation Date 03/12/2021  
Invitation Type Automatic  
Invitation Email(s) dougrucker21@gmail.com

Clean Ayr (Ayr Data, Inc.)

Address 1632 Mai Avenue  
Desoto, TX 75115 Participation Type: Active Supplier

Classifications SBE (Primary)

Invitation Date 03/12/2021  
Invitation Type Automatic  
Invitation Email(s) levin@cleanayr.com

cleaningessence LLC

Address 19716 SAUMS RD  
HOUSTON, TX 77084 Participation Type: Active Supplier

Classifications SBE (Primary)

Invitation Date 03/12/2021  
Invitation Type Automatic  
Invitation Email(s) john.taylor@cleaningessence.com

CleanNet of Houston

Address 9301 Southwest Freeway  
Houston, TX 77074 Participation Type: Active Supplier

Invitation Date 03/12/2021  
Invitation Type Automatic  
Invitation Email(s)

cLI-Energy and Construction LL

Address 12619 Northwood Colony Trail  
Houston, TX 77044 Participation Type: Active Supplier

Classifications MBE,SBE,HUB (Primary)

Invitation Date 03/12/2021  
Invitation Type Automatic  
Invitation Email(s) tharts@cli-energyandconstruction.com

Clifford Power Systems, Inc.

Address PO Box 875500  
Kansas City, MO 64187-5500 Participation Type: Active Supplier

Classifications SBE (Primary)

Invitation Date 03/12/2021  
Invitation Type Automatic  
Invitation Email(s) rmills@cliffordpower.com

CMC Construction Services (CMC Steel Fabricators)

Address 4846 Singleton Blvd.  
Dallas, TX 75212 Participation Type: Active Supplier

Invitation Date 03/12/2021  
Invitation Type Automatic  
Invitation Email(s) mike.trull@cmc.com

CMC Development & Construction Corporation LLC

Address P.O. Box 450623  
Houston, TX 77245 Participation Type: Active Supplier

Invitation Date 03/12/2021  
Invitation Type Automatic  
Invitation Email(s)

CMST, LLC (Construction Managers of Southeast Texas, LLC)

---

Address 225 Highway 365 Participation Type: Active Supplier  
Port Arthur, TX 77640

Invitation Date 03/12/2021  
Invitation Type Automatic  
Invitation Email(s) breyes@cmosetx.com  
Response Date 05/07/2021  
Response Status Submitted  
Status Date 05/07/2021

Coastal Air Balance Corp.

---

Address 1005 Harimaw CT. West STE 102 Participation Type: Active Supplier  
Metairie, LA 70001

Invitation Date 03/12/2021  
Invitation Type Automatic  
Invitation Email(s) john@coastalabcorp.com

Coastal Remediation

---

Address 1635 Dickinson Ave. Participation Type: Active Supplier  
Dickinson, TX 77539

Invitation Date 03/12/2021  
Invitation Type Automatic  
Invitation Email(s) ccotton@spauldingdecon.com

Coit, Inc. (Coit Services)

---

Address 9001 Spring Branch Drive Participation Type: Active Supplier  
Houston, TX 77080

Classifications TAS (Primary)

Invitation Date 03/12/2021  
Invitation Type Automatic  
Invitation Email(s) kathy.baba@coit.com robert.gonzalez@coit.com rafael.velasco@coit.com  
Response Status Viewed  
Status Date 04/28/2021

COLEXAS DIGITAL INC

---

Address 19827 Hamlet Shadow Lane Participation Type: Active Supplier  
Cypress, TX 77433

Classifications MBE (Primary),SBE

Invitation Date 03/12/2021  
Invitation Type Automatic  
Invitation Email(s) cturk@colexas.com jsisk@colexas.com

Collaborate PM LLC

---

Address 3302 Canal Street, Suite 36 Participation Type: Active Supplier  
Houston, TX 77003

Classifications MBE (Primary),HUB

Invitation Date 03/12/2021  
Invitation Type Automatic  
Invitation Email(s) dkaczynski@collaborate-llc.com

Colonial Roofing

---

Address 201 Main St Participation Type: Active Supplier  
Fort Worth, TX 76201

Invitation Date 03/12/2021  
Invitation Type Automatic  
Invitation Email(s) katrina@2tierwholesaleinc.com

Combined Refrigeration Resources, Inc.

Address 1118 1st Street East Participation Type: Active Supplier  
Humble, TX 77338

Invitation Date 03/12/2021  
Invitation Type Automatic  
Invitation Email(s) service@combinedrefrigeration.com

Comex Corporation

Address 9841 Spencer Hwy Participation Type: Active Supplier  
La Porte, TX 77571

Invitation Date 03/12/2021  
Invitation Type Automatic  
Invitation Email(s) davidaw@comexcorp.com

Comflow Mechanical Services

Address 6411 Lawford Lane Participation Type: Active Supplier  
Houston, TX 77040

Invitation Date 03/12/2021  
Invitation Type Automatic  
Invitation Email(s) cevett@comflowco.com

Comfort Systems USA - South Central

Address 9745 Bent Oak Drive Participation Type: Active Supplier  
Houston, TX 77040

Classifications TAS (Primary)

Invitation Date 03/12/2021  
Invitation Type Automatic  
Invitation Email(s) jon.parow@comfortsystemsusa.com

Commercial Equipment & Sales Co.

Address 1518 Paige St. Participation Type: Active Supplier  
Houston, TX 77003

Invitation Date 03/12/2021  
Invitation Type Automatic  
Invitation Email(s) sales@commercialequipmentandsales.com

Commercial Wallcovering Corp.

Address 15702 Baldswelle Dr Participation Type: Active Supplier  
Tomball, TX 77377

Classifications MBE (Primary)

Invitation Date 03/12/2021  
Invitation Type Automatic  
Invitation Email(s) rvasquezcwc@aol.com

Commerical Wallcovering Corp.

Address 830 W. 22nd St Participation Type: Active Supplier  
Houston, TX 77008

Classifications MBE,SBE (Primary)

Invitation Date 03/12/2021  
Invitation Type Automatic  
Invitation Email(s) rvasquezcwc@aol.com

Complete Companies Inc

Address 463 Raccoon Hill Road  
Salisbury, NH 03268 Participation Type: Active Supplier

Invitation Date 03/12/2021  
Invitation Type Automatic  
Invitation Email(s) sales@completecompaniesinc.com

Complete Electrical Services of Texas, Inc.

Address 200 N. Broadway  
La Porte, TX 77571 Participation Type: Active Supplier

Classifications SBE (Primary)

Invitation Date 03/12/2021  
Invitation Type Automatic  
Invitation Email(s) bobs@completeelectricalservices.com

CompuPro Global (Rita's Tape Media)

Address 4888 Langfield Road  
Houston, TX 77040 Participation Type: Active Supplier

Classifications SBE,WBE (Primary)

Invitation Date 03/12/2021  
Invitation Type Automatic  
Invitation Email(s) ginnib@compuproglobal.com

Concept Facility Services LLC

Address 646 E hwy67  
Duncanville, TX 75137 Participation Type: Active Supplier

Classifications MBE,TCP,SBE (Primary),HUB

Invitation Date 03/12/2021  
Invitation Type Automatic  
Invitation Email(s) freeney@conceptsvecs.com

CONCORD COMMERCIAL SERVICES, INC

Address 11400 LONG ST.  
BALCH SPRINGS, TX 75180 Participation Type: Active Supplier

Invitation Date 03/12/2021  
Invitation Type Automatic  
Invitation Email(s) pjones@ccsinctx.com

ConEdison Solutions (Consolidated Edison, Inc.)

Address 602 Kingfisher Creek Drive  
Austin, TX 78748 Participation Type: Active Supplier

Classifications TPA (Primary)

Invitation Date 03/12/2021  
Invitation Type Automatic  
Invitation Email(s)

Connecticut

Address 450 Columbus Boulevard, Suite 5  
Hartford, CT 06103 Participation Type: Active Supplier

Invitation Date 03/12/2021  
Invitation Type Manual  
Invitation Email(s)

Consolidated Services of North America (Ximena Ramirez)

---

Address 5833 Westview Dr  
Houston, TX 77055 Participation Type: Active Supplier

Classifications HUB (Primary),WBE

Invitation Date 03/12/2021  
Invitation Type Automatic  
Invitation Email(s) dylan@csnatx.com  
Response Date 05/07/2021  
Response Status Submitted  
Status Date 05/07/2021

Constructconnect

---

Address 3825 Edwards road  
cincinnati, OH 45209 Participation Type: Active Supplier

Classifications SBE (Primary)

Invitation Date 03/12/2021  
Invitation Type Automatic  
Invitation Email(s) content@constructconnect.com  
Response Status Viewed  
Status Date 04/28/2021

Construction Bid Source

---

Address 6265 HWY 9  
Felton, CA 95018 Participation Type: Active Supplier

Classifications MBE,DIR,SBE (Primary),WBE

Invitation Date 03/12/2021  
Invitation Type Automatic  
Invitation Email(s) pgibson@constructionbidsource.com

Construction Diversity Group

---

Address 15311 West Vantage Pkwy  
Houston, TX 77032 Participation Type: Active Supplier

Classifications MBE,SBE,HUB (Primary)

Invitation Date 03/12/2021  
Invitation Type Automatic  
Invitation Email(s) lrauls@cdgroup.us

Construction EcoServices

---

Address 13810 Hollister Dr.  
Houston, TX 77086 Participation Type: Active Supplier

Response Status Unsubmitted  
Status Date 05/17/2021

Construction Journal

---

Address 400 SW 7th Street  
Stuart, FL 34994 Participation Type: Active Supplier

Invitation Date 03/12/2021  
Invitation Type Automatic  
Invitation Email(s)

Construction Masters of Houston, Inc

---

Address PO Box 1587  
Pearland, TX 77588 Participation Type: Active Supplier

Invitation Date 03/12/2021  
Invitation Type Automatic  
Invitation Email(s) justin@cmhou.com

Continuum Restoration Services, LLC

---

Address 229 Heymann Blvd Participation Type: Active Supplier  
Lafayette, LA 70501

Invitation Date 03/12/2021  
Invitation Type Automatic  
Invitation Email(s) hans@robertsonec.com

CORE construction services of Texas, Inc.

---

Address 10625 North County Road Participation Type: Active Supplier  
Frisco, TX 75033

Invitation Date 03/12/2021  
Invitation Type Automatic  
Invitation Email(s) davewilson@coreconstruction.com

CORESTONE CONSTRUCTION SERVICES (RMB MANAGEMENT)

---

Address 14511 MARY JANE LANE Participation Type: Active Supplier  
TOMBALL, TX 77377

Classifications SBE

Invitation Date 04/16/2021  
Invitation Type Manual  
Invitation Email(s) jcalhoon@corestonecs.com  
Response Date 05/06/2021  
Response Status Submitted  
Status Date 05/06/2021

Corporate Care

---

Address 3530 W. T.C. Jester Blvd Participation Type: Active Supplier  
Houston, TX 77018

Invitation Date 03/12/2021  
Invitation Type Automatic  
Invitation Email(s) sbarnett@corporatecare.com vevans@corporatecare.com adavis@corporatecare.com  
Response Date 03/22/2021  
Response Status No Bid  
Status Date 03/12/2021

Corporate Vision Inc

---

Address 8307 Office Park Dr. Participation Type: Active Supplier  
Douglasville, GA 30134

Invitation Date 03/12/2021  
Invitation Type Automatic  
Invitation Email(s) corpvisioninc@gmail.com  
Response Status Viewed  
Status Date 04/28/2021

Correct Electric Inc

---

Address 6610 SUppl Row Participation Type: Active Supplier  
Houston, TX 77011

Classifications SBE (Primary)

Invitation Date 03/12/2021  
Invitation Type Automatic  
Invitation Email(s) sean@correctinc.com rgarzajr@correctinc.com



Cosmos Construction, Inc.

Address 1118 Kanah Lane  
Houston, TX 77090 Participation Type: Active Supplier

Classifications SBE (Primary),HUB,WBE

Invitation Date 03/12/2021  
Invitation Type Automatic  
Invitation Email(s) bwholley@aol.com

Cossey's Services, LLC

Address 25700 I-45 North Suite 400-105  
The Woodlands, TX 77368 Participation Type: Active Supplier

Classifications MBE (Primary),SBE,WBE

Invitation Date 03/12/2021  
Invitation Type Automatic  
Invitation Email(s) info@cosseysservices.us

Cotton Commercial USA

Address 5443 Katy Hockley Cutoff  
Katy, TX 77493 Participation Type: Active Supplier

Classifications HGA (Primary),TCP,TPA

Invitation Date 03/12/2021  
Invitation Type Automatic  
Invitation Email(s) jennifer.fox@cottonteam.com

Council Rock Enterprises, LLC

Address 11 Centre Park  
Rochester, NY 14614 Participation Type: Active Supplier

Classifications MBE,SBE,HUB (Primary)

Invitation Date 03/12/2021  
Invitation Type Automatic  
Invitation Email(s)

Covid Safety Glass (Silent West LLC)

Address 5972 TUNBRIDGE AVE  
LAS VEGAS, NV 89139 Participation Type: Active Supplier

Classifications SBE (Primary)

Invitation Date 03/12/2021  
Invitation Type Automatic  
Invitation Email(s)

Coyote Innovations (Coyote Marketing llc)

Address 12911 TAYLORCREST RD  
HOUSTON, TX 77079 Participation Type: Active Supplier

Classifications MBE,SBE (Primary),HUB,WBE

Invitation Date 03/12/2021  
Invitation Type Automatic  
Invitation Email(s) coyote.oviedo@gmail.com

CRAFT SAFETY INSPECTIONS (JMAC GROUP LLC)

Address 9894 Bissonnet St  
HOUSTON, TX 77036 Participation Type: Active Supplier

Classifications MBE,TPA,SBE,HUB (Primary),WBE

Invitation Date 03/12/2021  
Invitation Type Automatic  
Invitation Email(s) rcraft@csinspector.com

Crawford Industrial Services, LLC.

Address 3811 1/2 FM 646 N  
Santa Fe, TX 77510 Participation Type: Active Supplier

Invitation Date 03/12/2021  
Invitation Type Automatic  
Invitation Email(s) roberthargraves@crawfordindustrialservices.com

CRG Texas Environmental Services

Address 2504 Avenue I  
Rosenberg, TX 77471 Participation Type: Active Supplier

Classifications SBE (Primary),HUB

Invitation Date 03/12/2021  
Invitation Type Automatic  
Invitation Email(s) nubia@crgtexas.com

Crimson Vision Enterprises

Address 2311 24th Street  
Dickinson, TX 77573 Participation Type: Active Supplier

Invitation Date 03/12/2021  
Invitation Type Automatic  
Invitation Email(s) kimjyancy@gmail.com

Crosswinds Contracting

Address 2811 Beasley Rd  
Conroe, TX 77301 Participation Type: Active Supplier

Invitation Date 03/12/2021  
Invitation Type Automatic  
Invitation Email(s) tim@crosswindscontracting.org

CRT, GC DBA Caprock Construction

Address P.O. Box 54  
Wellborn, TX 77881-0054 Participation Type: Active Supplier

Invitation Date 03/12/2021  
Invitation Type Automatic  
Invitation Email(s)

CRX inc

Address 8720 Meadowcroft Dr.  
Houston, TX 77063 Participation Type: Active Supplier

Invitation Date 03/12/2021  
Invitation Type Automatic  
Invitation Email(s) alexk@crxhouston.com

Crystal Facility Solutions

---

Address 11011 S Wilcrest Dr. Suite B Participation Type: Active Supplier  
Houston, TX 77099

Classifications SBE (Primary)

Invitation Date 03/12/2021  
Invitation Type Automatic  
Invitation Email(s) accounting@cfshouston.com

CS Construction and Development (TRESAN COMPANY)

---

Address 416w. 9th st suite 4 Participation Type: Active Supplier  
mission, TX 78572

Invitation Date 03/12/2021  
Invitation Type Automatic  
Invitation Email(s) jesus\_trevino\_s@yahoo.com

CSJ Group

---

Address P.O. Box 3293 Participation Type: Active Supplier  
Edinburg, TX 78540

Invitation Date 03/12/2021  
Invitation Type Automatic  
Invitation Email(s) eddiesaenz95@gmail.com

CVAL Innovations (CVAL Innovations LLC)

---

Address 9701 Raven Ln Participation Type: Active Supplier  
Irving, TX 75063

Invitation Date 03/12/2021  
Invitation Type Automatic  
Invitation Email(s) info@cvalinnovations.com

Cyclone FPV (Cyclone 3D, Inc.)

---

Address 5546 Silent Timber Path LN. Participation Type: Active Supplier  
Spring, TX 77386

Invitation Date 03/12/2021  
Invitation Type Automatic  
Invitation Email(s) schoolbids@cyclonefpv.com

D & G Quality Roofing Inc.

---

Address 4305 FM 1187 Participation Type: Active Supplier  
Burleson, TX 76063

Classifications SBE (Primary),HUB,WBE

Invitation Date 03/12/2021  
Invitation Type Automatic  
Invitation Email(s) christa@dgqroofing.com alan@dgqroofing.com

D & R Electric Company

---

Address 1430 N. Flores Participation Type: Active Supplier  
San Antonio, TX 78212

Classifications MBE,TAS,SBE (Primary),HUB,WBE

Invitation Date 03/12/2021  
Invitation Type Automatic  
Invitation Email(s) debbie.dnrelectric@yahoo.com

D.A.N.'s One Stop, LLC.

Address 108 Herndon Street  
Shreveport, LA 71101 Participation Type: Active Supplier

Classifications MBE (Primary),SBE

Invitation Date 03/12/2021  
Invitation Type Automatic  
Invitation Email(s) dracforme@gmail.com

D7 Roofing & Metal LLC

Address 8701 W Hardy Rd  
Houston, TX 77022 Participation Type: Active Supplier

Classifications MBE,SBE,HUB

Response Date 05/07/2021  
Response Status Submitted  
Status Date 05/07/2021

DAE & Associates, LTD dba Geotech Engineering and Testing

Address 17407 US Highway 59 North  
Houston, TX 77396 Participation Type: Active Supplier

Invitation Date 03/12/2021  
Invitation Type Automatic  
Invitation Email(s) de@geotecheng.com

Daise Management, LLC (Alfred Daise)

Address PO Box 58171  
Houston, TX 77258 Participation Type: Active Supplier

Classifications MBE (Primary),HUB,WBE

Invitation Date 03/12/2021  
Invitation Type Automatic  
Invitation Email(s) Dmllctx@gmail.com

Dale Dobbins

Address p.o.box 55546  
houston, TX 77055 Participation Type: Active Supplier

Invitation Date 03/12/2021  
Invitation Type Automatic  
Invitation Email(s) dobsdata@msn.com

Dalton Air Conditioning and Heating (Dalton Air Conditioning and Heating, LLC)

Address 5410 Brookside Rd  
Pearland, TX 77581 Participation Type: Active Supplier

Classifications SBE (Primary)

Response Date 05/05/2021  
Response Status Submitted  
Status Date 05/05/2021

Dalworth Lighting and Electrical LLC, (Dalworth Lighting and Electrical)

Address 2341 Blue Smoke Court N  
Forth Worth, TX 76227 Participation Type: Active Supplier

Invitation Date 03/12/2021  
Invitation Type Automatic  
Invitation Email(s) Susan@dalworthlighting.com

Dan Loc Group

---

Address 725 N. Drennan  
Houston, TX 77003 Participation Type: Active Supplier

Invitation Date 03/12/2021  
Invitation Type Automatic  
Invitation Email(s) pdiorio@danlocgroup.com

DANIEL GE CONSTRUCTION INC

---

Address 1573 Somerset Road  
San Antonio, TX 78211 Participation Type: Active Supplier

Invitation Date 03/12/2021  
Invitation Type Automatic  
Invitation Email(s) MIRIAM@DANIELGECONTRACTORS.COM

Danny's Laundry Service

---

Address 1001 Burke #B  
Pasadena, TX 77506 Participation Type: Active Supplier

Invitation Date 03/12/2021  
Invitation Type Automatic  
Invitation Email(s) texlaundry@yahoo.com

David James (David Hebert)

---

Address 628 SEMINOLE Dr  
KEMAH, TX 77565 Participation Type: Active Supplier

Classifications WBE (Primary)

Invitation Date 03/12/2021  
Invitation Type Automatic  
Invitation Email(s) David@DavidJames.info

DBI Construction Inc, (David Boggs dba DBI Construction)

---

Address 18227 Heathridge  
Cypress, TX 77433 Participation Type: Active Supplier

Classifications TAS,SBE (Primary)

Invitation Date 03/12/2021  
Invitation Type Automatic  
Invitation Email(s) dbiconstruction@hotmail.com

DBL Management Solutions

---

Address 3131 Quail Valley E Dr  
Missouri City, TX 77489 Participation Type: Active Supplier

Invitation Date 03/12/2021  
Invitation Type Automatic  
Invitation Email(s) angela@dblmgmtsol.com

DeAngelo Brothers LLC

---

Address 100 North Conahan Drive  
Hazleton, PA 18201 Participation Type: Active Supplier

Invitation Date 03/12/2021  
Invitation Type Automatic  
Invitation Email(s) research@dbiservices.com

DeArco Inc

Address PO Box 12143  
Odessa, TX 79762 Participation Type: Active Supplier

Classifications MBE (Primary),SBE,WBE

Invitation Date 03/12/2021  
Invitation Type Automatic  
Invitation Email(s) Stephanie@dearcoinc.net

Debbie J. Anders Consulting

Address 14519 Bladenboro Drive  
Cypress, TX 77429 Participation Type: Active Supplier

Invitation Date 03/12/2021  
Invitation Type Automatic  
Invitation Email(s) debbieanders@tlceng.com

Delaware

Address 100 Enterprise Place  
Dover, DE 19904 Participation Type: Active Supplier

Invitation Date 03/12/2021  
Invitation Type Manual  
Invitation Email(s)

Delta T Equipment

Address 10757 Cutten Rd Bldg#3  
Houston, TX 77066 Participation Type: Active Supplier

Classifications SBE (Primary)

Invitation Date 03/12/2021  
Invitation Type Automatic  
Invitation Email(s) scox@deltatequipment.com

DEMS,LLC

Address 11111 Katy Freeway Suite 910  
Houston, TX 77079 Participation Type: Active Supplier

Invitation Date 03/12/2021  
Invitation Type Automatic  
Invitation Email(s) olusola\_dosunmu@demsllc.com

Denton and Bradley Metal Solutions, INC

Address 9702 S Service Rd  
Big Spring, TX 79720 Participation Type: Active Supplier

Invitation Date 03/12/2021  
Invitation Type Automatic  
Invitation Email(s) stbradley@metalsolutionstx.com

DGR United

Address 6402 Oaknut Dr  
houston, TX 77088 Participation Type: Active Supplier

Classifications MBE (Primary),SBE,HUB

Invitation Date 03/12/2021  
Invitation Type Automatic  
Invitation Email(s) info@dgrunited.com

Diamond KK, Inc.

Address 11879 White Oak Pass  
Conroe, TX 77385 Participation Type: Active Supplier

Classifications MBE,TPA,SBE (Primary),HUB,WBE

Invitation Date 03/12/2021  
Invitation Type Automatic  
Invitation Email(s)

DIAZ-MEX CONSTRUCTION

Address 5915 S Brenwood Dr  
Katy, TX 77449 Participation Type: Active Supplier

Invitation Date 03/12/2021  
Invitation Type Automatic  
Invitation Email(s) diazestimatingd@gmail.com

DIG Engineers

Address 11 Greenway Plaza  
Houston, TX 77046 Participation Type: Active Supplier

Invitation Date 03/12/2021  
Invitation Type Automatic  
Invitation Email(s) marketing@leafengineers.com

Digital Air Control, Inc

Address 11251 Northwest Fwy  
Houston, TX 77092 Participation Type: Active Supplier

Classifications DIR,SBE

Invitation Date 03/12/2021  
Invitation Type Automatic  
Invitation Email(s) jrackel@dac-inc.com mgonzales@dac-inc.com sgoings@dac-inc.com  
Response Status Unsubmitted  
Status Date 05/11/2021

Dillon Construction & Renovations, LLC

Address 2437 Bay Area Blvd #53  
Houston, TX 77058 Participation Type: Active Supplier

Classifications MBE,SBE (Primary),WBE

Invitation Date 03/12/2021  
Invitation Type Automatic  
Invitation Email(s) dillonp73@gmail.com

Ditch Witch of Houston

Address 6807 W Little York Road  
Houston, TX 77040 Participation Type: Active Supplier

Classifications HGA (Primary)

Invitation Date 03/12/2021  
Invitation Type Automatic  
Invitation Email(s) dcraig@dwhouston.com

Diverse Consulting Enterprises, Inc.

Address 4848 Pin Oak Park  
HOUSTON, TX 77081 Participation Type: Active Supplier

Invitation Date 03/12/2021  
Invitation Type Automatic  
Invitation Email(s) Lisa.williams@dce-corp.com

Diversified Services LLC (Calvin's Diversified Services LLC)

---

Address 3214 GLENMONT RIDGE CT Participation Type: Active Supplier  
FRESNO, TX 77545

Classifications MBE (Primary),HUB

Invitation Date 03/12/2021  
Invitation Type Automatic  
Invitation Email(s) moore-calvin@sbcglobal.net

DivisionOne Construction LLC

---

Address 11280 West Road Participation Type: Active Supplier  
Houston, TX 77065

Classifications SBE (Primary)

Invitation Date 03/12/2021  
Invitation Type Automatic  
Invitation Email(s) tcallaway@d1construction.com zkoletar@d1construction.com bwatson@d1construction.com  
Response Status Viewed  
Status Date 05/04/2021

DNA Electrical Systems (AMA Quality, LLC)

---

Address p.o. box 710709 Participation Type: Active Supplier  
houston, TX 77271

Classifications MBE,SBE (Primary),WBE

Invitation Date 03/12/2021  
Invitation Type Automatic  
Invitation Email(s) deya@amaquality.com

DNB Enterprises, Inc.

---

Address 20560 FM 1488 Participation Type: Active Supplier  
Magnolia, TX 77355

Classifications SBE (Primary)

Invitation Date 03/12/2021  
Invitation Type Automatic  
Invitation Email(s) ron.gilbert@dnbent.com

Dodge Data & Analytics

---

Address #2 Penn Plaza 10th Floor Participation Type: Active Supplier  
New York, NY 10121

Invitation Date 03/12/2021  
Invitation Type Automatic  
Invitation Email(s)

DRC Emergency Services, LLC

---

Address 2930 A Jackson Participation Type: Active Supplier  
Houston, TX 77004

Classifications HGA (Primary)

Invitation Date 03/12/2021  
Invitation Type Automatic  
Invitation Email(s) lgarcia@drcusa.com



DRC Fort Worth, LLC (DRC Fort Worth LLC)

Address 13562 Brett Jackson Rd  
Fort Worth, TX 76179 Participation Type: Active Supplier

Invitation Date 03/12/2021  
Invitation Type Automatic  
Invitation Email(s) cweidner@servpronorthfortworth.com  
Response Date 05/07/2021  
Response Status No Bid  
Status Date 05/07/2021

Dri Right Restoration Services of Texas

Address 5355 Dietrich Road STE 102  
San Antonio, TX 78219 Participation Type: Active Supplier

Invitation Date 03/12/2021  
Invitation Type Automatic  
Invitation Email(s) management@drirightoftexas.com

DrPowerWasher, Inc.

Address 1307 W. Main Street, Ste. B323  
Gun Barrel City, TX 75156 Participation Type: Active Supplier

Classifications SBE (Primary)  
Invitation Date 03/12/2021  
Invitation Type Automatic  
Invitation Email(s) sales@drpowerwashing.com

Drymalla Construction Company

Address 608 Harbert Street  
Columbus, TX 78934 Participation Type: Active Supplier

Invitation Date 03/12/2021  
Invitation Type Automatic  
Invitation Email(s) elabay@drymalla.com

Drymore Company

Address 8345 W. Little York Rd. Suite 2  
Houston, TX 77382 Participation Type: Active Supplier

Classifications SBE (Primary),HUB,WBE  
Invitation Date 03/12/2021  
Invitation Type Automatic  
Invitation Email(s) suzette@drymore.com

DT Construction, LP

Address 1023 North Houston Avenue  
Humble, TX 77338 Participation Type: Active Supplier

Invitation Date 03/12/2021  
Invitation Type Automatic  
Invitation Email(s) bids@dt-construction.com

Dunhill Development and Construction

Address 4801 Woodway Dr Suite 425W  
Houston, TX 77056 Participation Type: Active Supplier

Invitation Date 03/12/2021  
Invitation Type Automatic  
Invitation Email(s) abe@dunhilldevelopment.com

Duro-Last, Inc.

Address 525 Morley Drive Participation Type: Active Supplier  
Saginaw, MI 48601

Classifications TIP

Invitation Date 03/12/2021  
Invitation Type Automatic  
Invitation Email(s) cplyler@duro-last.com

Dust trappers llc

Address 700 UNION ST Participation Type: Active Supplier  
BIRDSBORO, PA 19508

Invitation Date 03/12/2021  
Invitation Type Automatic  
Invitation Email(s) Dusttrapperscleaning@gmail.com

Du-West Construction, Inc.

Address 510 W. Pasadena Fwy. Participation Type: Active Supplier  
Pasadena, TX 77506

Invitation Date 03/12/2021  
Invitation Type Automatic  
Invitation Email(s) brandon@du-west.com

dycor inc.

Address 2911 e broadway Participation Type: Active Supplier  
pearland, TX 77581

Invitation Date 03/12/2021  
Invitation Type Automatic  
Invitation Email(s) cdykes@sbcglobal.net

E & F Construction enterprises llc

Address 7539 fallcreek bend Participation Type: Active Supplier  
United States, TX 77396

Classifications MBE (Primary)

Invitation Date 03/12/2021  
Invitation Type Automatic  
Invitation Email(s) escarr1@yahoo.com

E & J Energy Solutions

Address PO Box 132492 Participation Type: Active Supplier  
The Woodlands, TX 77393

Classifications MBE (Primary)

Invitation Date 03/12/2021  
Invitation Type Automatic  
Invitation Email(s)

E Contractors LLC

Address 16554 Creek Bend Drive Participation Type: Active Supplier  
Sugar Land, TX 77478

Classifications MBE,TCP (Primary),SBE,HUB

Invitation Date 03/12/2021  
Invitation Type Automatic  
Invitation Email(s) iabji@econtractors.com mgarcia@econtractors.com wpaz@econtractors.com  
Response Date 04/26/2021  
Response Status No Bid  
Status Date 04/21/2021

E&V KITCHEN EXHAUST CLEANING

---

Address 1717 MONTROSE DRIVE Participation Type: Active Supplier  
RIVER OAKS, TX 76114

Invitation Date 03/12/2021  
Invitation Type Automatic  
Invitation Email(s) angelicaska.01@gmail.com

E.R.S., Inc. (Elevator Repair Service, Inc.)

---

Address P.O. Box 11037 Participation Type: Active Supplier  
Houston, TX 77293

Classifications SBE,HUB (Primary),WBE

Invitation Date 03/12/2021  
Invitation Type Automatic  
Invitation Email(s) bids@elevatorsrus.com  
Response Date 03/12/2021  
Response Status No Bid  
Status Date 03/12/2021

E3 Entegral Solutions, Inc

---

Address 2040 Highland Village Road Participation Type: Active Supplier  
Highland Village, TX 75077

Invitation Date 03/12/2021  
Invitation Type Automatic  
Invitation Email(s) jmccurley@e3es.com

EA Plumbing & Property Services (Evolution Alignment Inc)

---

Address 2450 Louisiana St. Participation Type: Active Supplier  
Houston, TX 77006

Classifications MBE (Primary),SBE,HUB

Invitation Date 03/12/2021  
Invitation Type Automatic  
Invitation Email(s) qhoward@eaprofessionalservices.com

Earl P. Forbrich, Jr. Inc

---

Address 238 Dinn Participation Type: Active Supplier  
San Antonio, TX 78218

Classifications SBE (Primary)

Invitation Date 03/12/2021  
Invitation Type Automatic  
Invitation Email(s) epfjrinc@aol.com

ECM International, Inc.

---

Address 404 Executive Center Participation Type: Active Supplier  
El Paso, TX 79902

Classifications MBE,SBE (Primary),HUB

Invitation Date 03/12/2021  
Invitation Type Automatic  
Invitation Email(s) mherrera@ecmintl.com

eco Construction, Inc.

---

Address 1200 Business Park Dr. Participation Type: Active Supplier  
Little Rock, AR 72204

Classifications SBE (Primary)

Invitation Date 03/12/2021  
Invitation Type Automatic  
Invitation Email(s) patrick@ecoconstructionar.com

ECO Restoration & Cleaning Services (ECO Clean LLC)

Address 2951 Marina Bay Drive  
League City, TX 77573 Participation Type: Active Supplier

Classifications SBE (Primary)

Invitation Date 03/12/2021  
Invitation Type Automatic  
Invitation Email(s) amanda@erc-services.com

ecoclean, llc

Address 19402 CHESTNUTFIELD CT  
HOUSTON, TX 77094 Participation Type: Active Supplier

Classifications SBE (Primary)

Invitation Date 03/12/2021  
Invitation Type Automatic  
Invitation Email(s) service@EcocleanUSA.com

EcoXstream, LLC

Address 7531 FM 2004  
Hitchcock, TX 77563 Participation Type: Active Supplier

Invitation Date 03/12/2021  
Invitation Type Automatic  
Invitation Email(s) gdaenen@ecoxstream.com  
Response Date 05/07/2021  
Response Status Submitted  
Status Date 05/07/2021

EDEL Roofing & Construction Inc.

Address 3321 W Alberta Rd.  
Edinburg, TX 78539 Participation Type: Active Supplier

Invitation Date 03/12/2021  
Invitation Type Automatic  
Invitation Email(s) eddie@edelroofing.com

Educational Systems Consulting

Address 60 Victoria Drive  
Binghamton, NY 13904 Participation Type: Active Supplier

Invitation Date 03/12/2021  
Invitation Type Automatic  
Invitation Email(s) consult@edsystemsconsulting.org

EE&G Construction & Electrical, LLC

Address 14505 Commerce Way  
Miami Lakes, FL 33016 Participation Type: Active Supplier

Invitation Date 03/12/2021  
Invitation Type Automatic  
Invitation Email(s)

EGC Inc

Address 17806 IH 10W Ste. 300  
San Antonio, TX 78230 Participation Type: Active Supplier

Classifications MBE (Primary),SBE,WBE

Invitation Date 03/12/2021  
Invitation Type Automatic  
Invitation Email(s) luis.dueno@egcincpro.com

EIKON Consultant Group, LLC

Address 1405 W Chapman Dr  
Sanger, TX 7626 Participation Type: Active Supplier

Invitation Date 03/12/2021  
Invitation Type Automatic  
Invitation Email(s) jesisbell@eikoncg.com

Electrical Tech Services, Inc.

Address 5903 Gardendale Dr.  
Houston, TX 77092 Participation Type: Active Supplier

Invitation Date 03/12/2021  
Invitation Type Automatic  
Invitation Email(s) estimating@electricaltechservices.com

Elite and Complete Services

Address 16322 Villaret Drive  
Houston, TX 77083 Participation Type: Active Supplier

Classifications MBE,SBE (Primary)

Invitation Date 03/12/2021  
Invitation Type Automatic  
Invitation Email(s) jaybooker@ymail.com

Elite One Construction Group

Address 1472 Champion Rd  
Terrell, TX 75160 Participation Type: Active Supplier

Classifications MBE (Primary)

Invitation Date 03/12/2021  
Invitation Type Automatic  
Invitation Email(s) pete@eliteonecg.com

Elite Pumps & Mechanical Services, LLC

Address 6102 Centralcrest Street  
Houston, TX 77092 Participation Type: Active Supplier

Invitation Date 03/12/2021  
Invitation Type Automatic  
Invitation Email(s) juan@elitepumps.net

Elite Water and Coffee

Address 710 Ridgewood Road  
Ridgeland, MS 39157 Participation Type: Active Supplier

Invitation Date 03/12/2021  
Invitation Type Automatic  
Invitation Email(s) greg@elitewaterandcoffee.com

E-Logic, Inc.

Address 1025 Connecticut Avenue NW  
Washington, DC 20036 Participation Type: Active Supplier

Invitation Date 03/12/2021  
Invitation Type Automatic  
Invitation Email(s) LPadilla@e-logic.us  
Response Date 04/02/2021  
Response Status No Bid  
Status Date 04/02/2021

ElstonAire Inc.

Address 727 E. Centre Park Blvd Participation Type: Active Supplier  
Desoto, TX 75115

Classifications MBE,TCP,TXM,SBE (Primary),HUB,WBE

Invitation Date 03/12/2021  
Invitation Type Automatic  
Invitation Email(s) demetra@elstonaire.com brandon@elstonaire.com

EM Office Services

Address 19747 U.S. Highway 59 North, Suite 322 Participation Type: Active Supplier  
Humble, TX 77338

Classifications WBE (Primary)

Invitation Date 03/12/2021  
Invitation Type Automatic  
Invitation Email(s) emartinez@emofficeservices.com

Ema Sport Solutions (Jhon Mario Madrigal)

Address 5680 hwy 6 Participation Type: Active Supplier  
Missouri city, TX 77459

Response Date 05/04/2021  
Response Status Submitted  
Status Date 05/04/2021

EMC Resurfacing

Address 7326 Palomino Bay Participation Type: Active Supplier  
San Antonio, TX 78252

Classifications MBE (Primary),SBE,HUB

Invitation Date 03/12/2021  
Invitation Type Automatic  
Invitation Email(s) emc1construction@gmail.com

Emerald Standard Services, Inc.

Address 520 Preston Ave. Participation Type: Active Supplier  
Pasadena, TX 77503

Classifications MBE,SBE (Primary),HUB

Invitation Date 03/12/2021  
Invitation Type Automatic  
Invitation Email(s) roger@emerald-standard.com

Emian Drywall and Renovating

Address 320 Menlo Drive Participation Type: Active Supplier  
Mesquite, TX 75149

Classifications SBE (Primary),WBE

Invitation Date 03/12/2021  
Invitation Type Automatic  
Invitation Email(s) cecilia.riveros.48@live.com

EMJ Corporation

Address 5525 N. MacArthur #400 Participation Type: Active Supplier  
Irving, TX 75038

Invitation Date 03/12/2021  
Invitation Type Automatic  
Invitation Email(s)

Enigma Electric LLC

Address 24415 Hyland Greens Lane Participation Type: Active Supplier  
Spring, TX 77373

Classifications MBE (Primary),SBE,HUB,WBE

Invitation Date 03/12/2021  
Invitation Type Automatic  
Invitation Email(s) Veronica@enigmaelectric.net

Enterprise Builders LLC

Address 7420 Hammerly Blvd Participation Type: Active Supplier  
Houston, TX 77055

Invitation Date 03/12/2021  
Invitation Type Automatic  
Invitation Email(s) avillegas@enterprisebuilders.com tkillion@enterprisebuilders.com info@enterprisebuilders.com

Entrust One Facility Services, Inc

Address 11142 Shady Trail Participation Type: Active Supplier  
Dallas, TX 75229

Classifications MBE,SBE (Primary),HUB,WBE

Invitation Date 03/12/2021  
Invitation Type Automatic  
Invitation Email(s)

Envirostatic, LLC

Address 211 Limewood Lane Participation Type: Active Supplier  
Temple, TX 76501

Classifications MBE,HUB (Primary)

Invitation Date 03/12/2021  
Invitation Type Automatic  
Invitation Email(s) sales@envirostatic.com

Epic Solar Control, LLC

Address 180 Industrial Blvd Ste R Participation Type: Active Supplier  
Mckinney, TX 75069

Invitation Date 03/12/2021  
Invitation Type Automatic  
Invitation Email(s) kelly@epicsolarcontrol.com

Epoxy Design Systems, Inc.

Address P.O. Box 19485 Participation Type: Active Supplier  
Houston, TX 77224-9485

Classifications SBE (Primary)

Invitation Date 03/12/2021  
Invitation Type Automatic  
Invitation Email(s) hank@epoxydesign.com

Equipment Management Services

Address 6910 S Lake Houston Pkwy Participation Type: Active Supplier  
Houston, TX 77049

Invitation Date 03/12/2021  
Invitation Type Automatic  
Invitation Email(s)

ERC Environmental & Construction Services, Inc.

Address 10801 Hammerly Blvd Participation Type: Active Supplier  
Houston, TX 77043

Classifications TIP (Primary)

Invitation Date 03/12/2021  
Invitation Type Automatic  
Invitation Email(s) apaterson@erc-tx.com kazarpour@erc-tx.com shoran@erc-tx.com

Evolve Holdings Inc

Address 10555 Cossey Road Participation Type: Active Supplier  
Houston, TX 77070

Invitation Date 03/12/2021  
Invitation Type Automatic  
Invitation Email(s) Melonie.milefchik@evolveincorporated.com Terra.lewis@evolveincorporated.com  
Lindy.Devitt@EvolveIncorporated.com  
Response Date 04/01/2021  
Response Status No Bid  
Status Date 04/01/2021

Excel Medical Waste

Address 6410 Long Drive Participation Type: Active Supplier  
Houston, TX 77087

Classifications SBE (Primary)

Invitation Date 03/12/2021  
Invitation Type Automatic  
Invitation Email(s)

Exclusive Windows & Doors (Pursuit Properties, LLC)

Address 1000 Jackson Blvd Participation Type: Active Supplier  
Houston, TX 77006

Invitation Date 03/12/2021  
Invitation Type Automatic  
Invitation Email(s)

Executive Pro High Cleaning Agency

Address 1435 Bolviar St Participation Type: Active Supplier  
Beaumont, TX 77701

Classifications HUB (Primary),WBE

Invitation Date 03/12/2021  
Invitation Type Automatic  
Invitation Email(s) executiveprohighcleaningagenc@gmail.com

ExerPlay, Inc

Address 12220 N Hwy 14, Suite 5 Participation Type: Active Supplier  
Cedar Crest, NM 87008

Invitation Date 03/12/2021  
Invitation Type Automatic  
Invitation Email(s) vicki@exerplay.com

Exterior Creations Inc

Address 12510 Donna Drive Participation Type: Active Supplier  
Houston, TX 77067

Invitation Date 03/12/2021  
Invitation Type Automatic  
Invitation Email(s) casey@ecitx.com



Extreme Air Duct Cleaning And Restoration Services

Address 5934 Rutherglenn Dr Participation Type: Active Supplier  
Houston, TX 77096

Invitation Date 03/12/2021  
Invitation Type Automatic  
Invitation Email(s) extremeairducthouston@yahoo.com

EZ-ACCESS (Homecare Products Inc.)

Address 700 Milwaukee Ave N. Participation Type: Active Supplier  
Algona, WA 98001

Invitation Date 03/12/2021  
Invitation Type Automatic  
Invitation Email(s) sled@ezaccess.com

F.H. Paschen, S.N.Nielsen & Associates LLC

Address 5515 N. East River Road Participation Type: Active Supplier  
Chicago, IL 60656

Invitation Date 03/12/2021  
Invitation Type Automatic  
Invitation Email(s) lwright@fhpaschen.com  
Response Status Viewed  
Status Date 04/27/2021

FACILITIES INTEGRATED SOLUTIONS & CONSULTING LLC

Address 21145 FM 529 SUITE 1114 Participation Type: Active Supplier  
CYPRESS, TX 77433

Classifications MBE,HUB (Primary),WBE

Invitation Date 03/12/2021  
Invitation Type Automatic  
Invitation Email(s) nhamler@fiscllc.com

Facilities Sources (Dura Pier Facilities Services Ltd.)

Address 13124 Player St. Participation Type: Active Supplier  
Houston, TX 77045

Classifications HUB,WBE

Invitation Date 03/12/2021  
Invitation Type Automatic  
Invitation Email(s) davidterry@facilitiesources.com jimburke@facilitiesources.com lriordan@austin.rr.com  
Rich@facilitiesources.com rich@facilitiesources.com tammi@facilitiesources.com  
tracy@facilitiesources.com wayne@facilitiesources.com  
Response Date 05/06/2021  
Response Status Submitted  
Status Date 05/06/2021

Facilities USA LLC

Address 55 Robins Ln. Participation Type: Active Supplier  
Brownsville, TX 78520

Classifications WBE (Primary)

Invitation Date 03/12/2021  
Invitation Type Automatic  
Invitation Email(s) fco\_rendon@hotmail.com

Facility Response Group

Address 100 Crescent Ct #700 Ste  
Dallas, TX 75201 Participation Type: Active Supplier

Invitation Date 03/12/2021  
Invitation Type Automatic  
Invitation Email(s)

Facility Solutions Group

Address 5091 Steadmont Dr  
Houston, TX 77040 Participation Type: Active Supplier

Invitation Date 03/12/2021  
Invitation Type Automatic  
Invitation Email(s) Briand@fsgi.com

Falkenberg Construction Company, Inc.

Address 4850 Samuell Blvd.  
Mesquite, TX 75149 Participation Type: Active Supplier

Classifications MBE,SBE (Primary),HUB

Invitation Date 03/12/2021  
Invitation Type Automatic  
Invitation Email(s) jcastro@falkenbergconstruction.com tgomez@falkenbergconstruction.com  
Response Date 05/06/2021  
Response Status Submitted  
Status Date 05/06/2021

Fazangelo Prosperity LLC

Address 26 pineneedle place  
the woodlands, TX 77382 Participation Type: Active Supplier

Classifications SBE (Primary)

Invitation Date 03/12/2021  
Invitation Type Automatic  
Invitation Email(s) fazandelatanja@gmail.com

Ferguson Enterprises Inc

Address 21250 foster road  
spring, TX 77388 Participation Type: Active Supplier

Invitation Date 03/12/2021  
Invitation Type Automatic  
Invitation Email(s) Andrew.Flynn@ferguson.com clinton.hudson@ferguson.com

FERN Environmental LLC

Address 1900 W. Gray St. #131631  
Houston, TX 77219 Participation Type: Active Supplier

Invitation Date 03/12/2021  
Invitation Type Automatic  
Invitation Email(s) greg@fernenvironmental.com

Fielder's Choice, Inc.

Address 7600 Joplin St  
Houston, TX 77087 Participation Type: Active Supplier

Invitation Date 03/12/2021  
Invitation Type Automatic  
Invitation Email(s) caleen@fielderschoiceinc.com

Filta (Seenandan LLC)

Address 5006 Longlane Dr  
Houston, TX 77084 Participation Type: Active Supplier

Classifications MBE (Primary)

Invitation Date 03/12/2021  
Invitation Type Automatic  
Invitation Email(s) Andrews@gofilta.com

FIRST NATIONAL HOMES,INC.

Address SAME  
SAME, TX SAME Participation Type: Active Supplier

Classifications MBE,SBE (Primary),HUB

Invitation Date 03/12/2021  
Invitation Type Automatic  
Invitation Email(s) fngroup@hotmail.com

FISHER TRACKS, INC.

Address 1313 thistle lane  
Masfield, TX 76063 Participation Type: Active Supplier

Classifications TCP (Primary),TIP

Invitation Date 03/12/2021  
Invitation Type Automatic  
Invitation Email(s)

Fix My Slab Foundation Repair (TDS Foundation Services)

Address 15702 Grant Road  
Cypress, TX 77429 Participation Type: Active Supplier

Classifications SBE (Primary)

Invitation Date 03/12/2021  
Invitation Type Automatic  
Invitation Email(s)

FJW Construction Company

Address 1301 S. Capital of Texas Hwy  
Austin, TX 78746 Participation Type: Active Supplier

Invitation Date 03/12/2021  
Invitation Type Automatic  
Invitation Email(s) bwhatley@fjwcc.com

Flagship Facility Services, Inc.

Address 1050 North 5th Street  
San Jose, CA 95112 Participation Type: Active Supplier

Invitation Date 03/12/2021  
Invitation Type Automatic  
Invitation Email(s)

Flicgroup (Federal lighting illumination capital)

Address 1256 Main Street  
Southlake, TX 76092 Participation Type: Active Supplier

Classifications SBE (Primary)

Invitation Date 03/12/2021  
Invitation Type Automatic  
Invitation Email(s) J.sheehan@flicgroup.com

Flintco, LLC

Address 2950 North Loop West, Suite 450 Participation Type: Active Supplier  
Houston, TX 77092

Response Date 05/07/2021  
Response Status Submitted  
Status Date 05/07/2021

FloorMasters (Cleaning Resource Systems Inc.)

Address 8907 Comal Street Participation Type: Active Supplier  
Houston, TX 77051

Classifications WBE (Primary)

Invitation Date 03/12/2021  
Invitation Type Automatic  
Invitation Email(s) marhonda.newman@floormastersolutions.com

floors 2 adore

Address 2314 alassio isle Participation Type: Active Supplier  
missori city, TX 77459

Classifications MBE,SBE,HUB

Invitation Date 03/12/2021  
Invitation Type Automatic  
Invitation Email(s) rjackson2adore@gmail.com

Floor-Tex Commercial Flooring, LLC

Address 18071 FM 1314 Participation Type: Active Supplier  
Conroe, TX 77302

Invitation Date 03/12/2021  
Invitation Type Automatic  
Invitation Email(s) Dspringer@floortextflooring.com eshumaker@floortextflooring.com

Florida

Address 4050 Esplanade Way Participation Type: Active Supplier  
Tallahassee, FL 32399

Invitation Date 03/12/2021  
Invitation Type Manual  
Invitation Email(s)

Floyd Billings Construction LLC.

Address 3935 s. Lancaster Rd Participation Type: Active Supplier  
Dallas,TX, TX 75216

Classifications MBE,SBE (Primary)

Invitation Date 03/12/2021  
Invitation Type Automatic  
Invitation Email(s) carltonbillings@sbcglobal.net

FMG Construction Development

Address 2555 N. MacGregor Way Participation Type: Active Supplier  
Houston, TX 77004

Classifications MBE (Primary),SBE,HUB

Invitation Date 03/12/2021  
Invitation Type Automatic  
Invitation Email(s) mmcloud.fmg@gmail.com

FMG Construction Group, LLC

Address 2555 N. MacGregor Way Participation Type: Active Supplier  
Houston, TX 77004

Classifications MBE,SBE,HUB (Primary)

Response Date 05/07/2021  
Response Status Submitted  
Status Date 05/07/2021

FMSG (Facilities Management Services Group)

Address 13705 W 51st St Participation Type: Active Supplier  
Shawnee, KS 66216

Classifications SBE (Primary)

Invitation Date 03/12/2021  
Invitation Type Automatic  
Invitation Email(s)

Foodservice Peeps LLC

Address 6510 Hope Canyon Lane Participation Type: Active Supplier  
Richmond, TX 77469

Classifications MBE (Primary),SBE

Invitation Date 03/12/2021  
Invitation Type Automatic  
Invitation Email(s) rolando.flores@foodservicepeeps.com

Fort Bend Mechanical & Construction LLC

Address 13802 Murphy Road Participation Type: Active Supplier  
Stafford, TX 77477

Invitation Date 03/12/2021  
Invitation Type Automatic  
Invitation Email(s) eric@fortbendmechanical.com

Foulke Rubber Products

Address 600 Linnerud Drive Participation Type: Active Supplier  
Sun Prairie, WI 53590

Invitation Date 03/12/2021  
Invitation Type Automatic  
Invitation Email(s) sophia@foulkerubber.com

Foundation Specialists

Address 5728 Teague Road Participation Type: Active Supplier  
Houston, TX 77041

Classifications MBE,SBE (Primary),HUB

Invitation Date 03/12/2021  
Invitation Type Automatic  
Invitation Email(s) tony@foundationexperts.com

Four Seasons Development Co, Inc.

Address 5825 W. Sam Houston Pkwy N. Participation Type: Active Supplier  
Houston, TX 77041

Invitation Date 03/12/2021  
Invitation Type Automatic  
Invitation Email(s) cmckinney@fourseasonsdevelopmentco.com julian@fourseasonsdevelopmentco.com

FRAGMA Construction Services, LLC

Address 9863 Tanner Road Suite H  
Houston, TX 77041 Participation Type: Active Supplier

Invitation Date 03/12/2021  
Invitation Type Automatic  
Invitation Email(s) manny@fragmaconstruction.com

Frame-Work Consult

Address 13211 DURBRIDGE TRAIL DRIVE  
HOUSTON, TX 77065 Participation Type: Active Supplier

Invitation Date 03/12/2021  
Invitation Type Automatic  
Invitation Email(s) info@f-wcon.com

Freese and Nichols, Inc.

Address 4055 International Plaza, #200  
Fort Worth, TX 76109 Participation Type: Active Supplier

Invitation Date 03/12/2021  
Invitation Type Automatic  
Invitation Email(s) leadservices@freese.com

Frontier Services Group

Address 13735 FM 529 Road  
Houston, TX 77041 Participation Type: Active Supplier

Invitation Date 03/12/2021  
Invitation Type Automatic  
Invitation Email(s) info@frontiergp.com

Frontier Waterproofing

Address 332 E. Oak St.  
Denton, TX 76201 Participation Type: Active Supplier

Classifications TCP,TIP,SBE (Primary),HUB

Invitation Date 03/12/2021  
Invitation Type Automatic  
Invitation Email(s) haleigh@frontierwaterproofing.com

Frost Construction Company Inc.

Address 8820 Will Clayton Pkwy  
Humble, TX 77338 Participation Type: Active Supplier

Invitation Date 03/12/2021  
Invitation Type Automatic  
Invitation Email(s) cfrost@frostconstruction.net sfrost@frostconstruction.net fcci@frostconstruction.net

FRS Trenchcore

Address 7911 Buffalo View Ln  
cypress, TX 77433 Participation Type: Active Supplier

Invitation Date 03/12/2021  
Invitation Type Automatic  
Invitation Email(s) company@trenchcore.com

FSI Construction, Inc.

Address 5728 Teague Road  
Houston, TX 77041 Participation Type: Active Supplier

Classifications MBE,SBE (Primary)

Invitation Date 03/12/2021  
Invitation Type Automatic  
Invitation Email(s) tony@fsiconstruction.com

Ft Worth Refinishing (RUBBER DUCK LLC)

Address 701 Timberline Ct  
Arlington, TX 76006 Participation Type: Active Supplier

Invitation Date 03/12/2021  
Invitation Type Automatic  
Invitation Email(s) martin.rugroden@tx.rr.com

Fujitec America, Inc.

Address 1707 Briercroft Court  
Carrollton, TX 75006 Participation Type: Active Supplier

Invitation Date 03/12/2021  
Invitation Type Automatic  
Invitation Email(s) lharrison@fujitecamerica.com

G.I. Construction Management LLC

Address 4261 E University Dr  
Prosper, TX 75078 Participation Type: Active Supplier

Invitation Date 03/12/2021  
Invitation Type Automatic  
Invitation Email(s) dustin@giconstructionmanagement.com  
Response Status Viewed  
Status Date 04/27/2021

G4C Enterprises, LLC

Address P.O. Box 1272  
Pflugerville, TX 78691 Participation Type: Active Supplier

Classifications MBE,SBE,HUB (Primary)

Invitation Date 03/12/2021  
Invitation Type Automatic  
Invitation Email(s) gary@g4centerprisesllc.com

G5 Construction (G5 GC LLC)

Address 13121 Louetta Road  
Cypress, TX 77429 Participation Type: Active Supplier

Classifications MBE (Primary),SBE,HUB

Invitation Date 03/12/2021  
Invitation Type Automatic  
Invitation Email(s) ov@g5construction.com

Gamma Construction

Address 2808 Joanel  
Houston, TX 77027 Participation Type: Active Supplier

Invitation Date 03/12/2021  
Invitation Type Automatic  
Invitation Email(s) phaynes@gammaconst.com

Gary's Lonestar Pump LLC (Lone Star Pump Repair & Service)

Address 31 Dogwood Pl,CR 3562  
New Caney, TX 77357 Participation Type: Active Supplier

Classifications HUB (Primary)

Invitation Date 03/12/2021  
Invitation Type Automatic  
Invitation Email(s) g.phillips01@sbcglobal.net

Gazelle Capital, LLC

Address 6785 58TH AVE N Participation Type: Active Supplier  
Saint Petersburg, FL 33709

Classifications SBE (Primary)

Invitation Date 03/12/2021  
Invitation Type Automatic  
Invitation Email(s) bids@gazelle.capital

Geaux Crates & Storage, LLC

Address 14504 North Freeway Participation Type: Active Supplier  
Houston, TX, TX 77090

Invitation Date 03/12/2021  
Invitation Type Automatic  
Invitation Email(s) kerry@geauxcrates.com

Gemini Services

Address 546 Southlake Drive Participation Type: Active Supplier  
Bullard, TX 75757

Classifications SBE (Primary)

Invitation Date 03/12/2021  
Invitation Type Automatic  
Invitation Email(s) aprilashley@geminisvc.com

General Commercial Solutions, LLC

Address 16503 BLUFF SPRINGS DR Participation Type: Active Supplier  
HOUSTON, TX 77095

Classifications MBE (Primary),SBE,WBE

Invitation Date 03/12/2021  
Invitation Type Automatic  
Invitation Email(s) janie@gcshtx.com  
Response Status Viewed  
Status Date 04/30/2021

General Contractor Services, Inc.

Address 8400 La Porte Rd Participation Type: Active Supplier  
Houston, TX 77012

Classifications TPA,SBE (Primary),HUB,WBE

Invitation Date 03/12/2021  
Invitation Type Automatic  
Invitation Email(s) genconser@aol.com

General Sports Surfaces LLC

Address 8717 Forum Way Participation Type: Active Supplier  
Fort Worth, TX 76140

Invitation Date 03/12/2021  
Invitation Type Automatic  
Invitation Email(s) l.puentes@generalss.com

Generocity Services Inc.

Address 1212 Winding Way Participation Type: Active Supplier  
Friendswood, TX 77546

Invitation Date 03/12/2021  
Invitation Type Automatic  
Invitation Email(s) CHAD@GENEROCITYSERVICES.COM  
Response Date 05/03/2021  
Response Status Submitted  
Status Date 05/03/2021



Gene's Machine, INC.

---

Address 235 Leeper Lane Participation Type: Active Supplier  
Victoria, TX 77904

Invitation Date 03/12/2021  
Invitation Type Automatic  
Invitation Email(s) mattapodackis@genesmachine.com

GeoSolutions, Inc. (Southwest GeoSolutions, Inc.)

---

Address 13812 Aston St Participation Type: Active Supplier  
Houston, TX 77040

Response Status Viewed  
Status Date 05/07/2021

Gerloff Company Inc.

---

Address 14955 Bulvered Rd Participation Type: Active Supplier  
San Antonio, TX 78247

Classifications TAS (Primary)

Invitation Date 03/12/2021  
Invitation Type Automatic  
Invitation Email(s) jgregory@gerloffinc.com jtitus@gerloffinc.com

Gilbane Building Company

---

Address 811 Main St Participation Type: Active Supplier  
Houston, TX 77002

Invitation Date 03/12/2021  
Invitation Type Automatic  
Invitation Email(s) jvalha@gilbaneco.com

Glenn Mikeska Enterprises LLC

---

Address 1201 Cardiff Road Participation Type: Active Supplier  
Brookshire, TX 77423

Invitation Date 03/12/2021  
Invitation Type Automatic  
Invitation Email(s)

Global Disaster Services, Inc.

---

Address 8050 Evangeline Lane Participation Type: Active Supplier  
Beaumont, TX 77706

Classifications SBE (Primary)

Invitation Date 03/12/2021  
Invitation Type Automatic  
Invitation Email(s)

Global Waste Services LLC

---

Address 7213 E Mount Houston Rd Participation Type: Active Supplier  
Houston, TX 77050

Invitation Date 03/12/2021  
Invitation Type Automatic  
Invitation Email(s) jrocha@globalwasteusa.com

Goldstone Exterior Services

---

Address 1721 Oak Tree Drive Participation Type: Active Supplier  
Houston, TX 77080

Invitation Date 03/12/2021  
Invitation Type Automatic  
Invitation Email(s) scott@goldstoneexterior.com

Good ol Boyz Plumbing (MDM Plumbing Services LLC)

Address 220 S. 1ST Street  
Sanger, TX 76266 Participation Type: Active Supplier

Invitation Date 03/12/2021  
Invitation Type Automatic  
Invitation Email(s)

graham county land company

Address 750 Tallulah Road  
Robbinsville, NC 28771 Participation Type: Active Supplier

Classifications SBE (Primary)

Invitation Date 03/12/2021  
Invitation Type Automatic  
Invitation Email(s) dwayne@gclnc.com

Grassroots Construction & Maintenance LLC

Address 5645 Hillcroft # 305  
Houston, TX 77036 Participation Type: Active Supplier

Classifications SBE (Primary)

Invitation Date 03/12/2021  
Invitation Type Automatic  
Invitation Email(s)

Graves Mechanical Inc

Address 5910 Schumacher Lane  
Houston, TX 77057 Participation Type: Active Supplier

Invitation Date 03/12/2021  
Invitation Type Automatic  
Invitation Email(s) pturner@gravesmechanical.com

Gray Mechanical (Gray Mechanical, LLC)

Address 15534 West Hardy Rd. Ste. 100  
Houston, TX 77060 Participation Type: Active Supplier

Invitation Date 03/12/2021  
Invitation Type Automatic  
Invitation Email(s) jody.vowell@graymechanical.com

Green Site, LLC

Address 7828 Millers Corner  
Elkridge, MD 21075 Participation Type: Active Supplier

Invitation Date 03/12/2021  
Invitation Type Automatic  
Invitation Email(s) ray@greensitesales.com

Greywater Holding LLC dba X8 Environmental

Address 1110 N AVE. T  
LUBBOCK, TX 79415 Participation Type: Active Supplier

Invitation Date 03/12/2021  
Invitation Type Automatic  
Invitation Email(s) dburnett@x8e.us

Groundbreaker Construction

Address 9898 Bissonnet  
Houston, TX 77036 Participation Type: Active Supplier

Classifications MBE (Primary)

Invitation Date 03/12/2021  
Invitation Type Automatic  
Invitation Email(s) roger@gbreaker.com

GSI Highway

Address 2861 S Bellline Rd  
Dallas, TX 75253 Participation Type: Active Supplier

Classifications SBE (Primary)

Invitation Date 03/12/2021  
Invitation Type Automatic  
Invitation Email(s) valeriec@gsihighway.com

Gulf Coast Boiler Service Co. (TK Boilers, LLC)

Address 14149 Interdrive W.  
Houston, TX 77032 Participation Type: Active Supplier

Classifications SBE (Primary)

Invitation Date 03/12/2021  
Invitation Type Automatic  
Invitation Email(s) todd@gulfcoastboiler.com sales@gulfcoastboiler.com

Gulf Coast Painting & Construction

Address PO Box 531647  
Harlingen, TX 78553 Participation Type: Active Supplier

Classifications MBE (Primary)

Invitation Date 03/12/2021  
Invitation Type Automatic  
Invitation Email(s) gcpsa92@yahoo.com

Gulf States Laundry Machinery

Address 12647 Memorial Drive  
Houston, TX 77024 Participation Type: Active Supplier

Invitation Date 03/12/2021  
Invitation Type Automatic  
Invitation Email(s) laundrylady2015@gmail.com

Gulftex (B J Interest, Inc.)

Address 7710 Cherry Park Dr., Suite T-425  
Houston, TX 77095 Participation Type: Active Supplier

Classifications SBE (Primary)

Invitation Date 03/12/2021  
Invitation Type Automatic  
Invitation Email(s) billt@gulftex92.com

Gutier Roofing & Sheet Metal (Gutier LLC)

Address 3536 NAVIGATION BLVD.  
HOUSTON, TX 77003 Participation Type: Active Supplier

Invitation Date 03/12/2021  
Invitation Type Automatic  
Invitation Email(s) jorge.mancilla@gutier.com  
Response Date 05/07/2021  
Response Status Submitted  
Status Date 05/07/2021

GW Phillips Concrete Construction, Inc.

Address 117 Oates Rd  
Houston, TX 77013 Participation Type: Active Supplier

Classifications SBE (Primary)

Invitation Date 03/12/2021  
Invitation Type Automatic  
Invitation Email(s) accounting@gwphillipsconstruction.com

H & H Skylight Fabricators, LLC

Address 13003 Murphy Road, Ste. K1  
Stafford, TX 77477 Participation Type: Active Supplier

Invitation Date 03/12/2021  
Invitation Type Automatic  
Invitation Email(s) Fdawson@hhs skylights.com

H.B. Neild & Sons, Inc.

Address 5950 Walden Rd.  
Beaumont, TX 77720 Participation Type: Active Supplier

Invitation Date 03/12/2021  
Invitation Type Automatic  
Invitation Email(s) SDaniels@HBNeild.com  
Response Date 05/07/2021  
Response Status Submitted  
Status Date 05/07/2021

Haldeman Homme

Address 16540 Air Center Blvd  
Houston, TX 77032 Participation Type: Active Supplier

Invitation Date 03/12/2021  
Invitation Type Automatic  
Invitation Email(s) cgregerson@haldemanhomme.com

Hallmark Mitigation & Construction

Address 703 Golden Bear Lane  
Kingwood, TX 77339 Participation Type: Active Supplier

Classifications SBE,WBE (Primary)

Invitation Date 03/12/2021  
Invitation Type Automatic  
Invitation Email(s) jhallmark@hallmark-mc.com

hard work construction

Address 351 scott rd  
cleveland, TX 77328 Participation Type: Active Supplier

Classifications SBE (Primary)

Invitation Date 03/12/2021  
Invitation Type Automatic  
Invitation Email(s) bobbyr9@aol.com

Hardy Construction (Hardy Stephenson LLC)

Address 4215 Carter Ferry Rd  
Milam,, TX 75959 Participation Type: Active Supplier

Classifications SBE (Primary)

Invitation Date 03/12/2021  
Invitation Type Automatic  
Invitation Email(s) steve@hardyconstructioncompany.com

Hardy England, Spanco Building System

Address 2924 Margarita Loop  
Round Rock, TX 78665 Participation Type: Active Supplier

Invitation Date 03/12/2021  
Invitation Type Automatic  
Invitation Email(s) elking@spanco-building-systems.com

Harness Roofing Inc.

Address 415 South Main  
Harrison, AR 72601 Participation Type: Active Supplier

Invitation Date 03/12/2021  
Invitation Type Automatic  
Invitation Email(s) dwallin@harnessroofing.com

Harris Construction (RJ Harris Construction (Gulf Coast)LP)

Address 611 FM 1960 Bypass Road East  
Humble, TX 77338 Participation Type: Active Supplier

Classifications HUB,WBE (Primary)

Invitation Date 03/12/2021  
Invitation Type Automatic  
Invitation Email(s) bids@harrisconstruction.us.com

Harrison, Walker & Harper, LP

Address 2510 S. Church Street  
Paris, TX 75460 Participation Type: Active Supplier

Invitation Date 03/12/2021  
Invitation Type Automatic  
Invitation Email(s) jdavis@hwh1887.com

Harvest Innovative Solutions LLC

Address PO Box 1020  
Pinehurst, TX 77362 Participation Type: Active Supplier

Invitation Date 03/12/2021  
Invitation Type Automatic  
Invitation Email(s) johnfollis@teamHIS.com john@hi-markroofing.com follis\_accounting@att.net

HB Construction

Address 3223 S. Loop 289  
Lubbock, TX 79423 Participation Type: Active Supplier

Invitation Date 03/12/2021  
Invitation Type Automatic  
Invitation Email(s) chrisl@hbconstruction.com

Heaton Electric, LLC

Address 1264 Hamilton Dr.  
Waco, TX 76705 Participation Type: Active Supplier

Invitation Date 03/12/2021  
Invitation Type Automatic  
Invitation Email(s) heatelec@yahoo.com

Heavy Equipment Rentals of Texas (Golden Empire Equipment)

Address 4629 Priem Ln.  
Pflugerville, TX 78660 Participation Type: Active Supplier

Classifications SBE (Primary)

Invitation Date 03/12/2021  
Invitation Type Automatic  
Invitation Email(s) jeff@heavyequipmentrentalsoftexas.com

Heights Builders (Heights Commercial Paint Contractors, Inc.)

Address 1149 W. 19th Street Participation Type: Active Supplier  
Houston, TX 77008

Classifications SBE (Primary)

Invitation Date 03/12/2021  
Invitation Type Automatic  
Invitation Email(s) paintcomm@yahoo.com

Hendee Enterprises, Inc.

Address 9350 South Point Drive Participation Type: Active Supplier  
Houston, TX 77054

Invitation Date 03/12/2021  
Invitation Type Automatic  
Invitation Email(s)

HENECO ENGINEERING AND CONSULTING

Address 810 Highway 6 South Participation Type: Active Supplier  
Houston, TX 77079

Invitation Date 03/12/2021  
Invitation Type Automatic  
Invitation Email(s) alex.dawotola@heneco.com

Henthorn Commercial Construction, LLC

Address 2011 Avenue C Participation Type: Active Supplier  
Lubbock, TX 79404

Invitation Date 03/12/2021  
Invitation Type Automatic  
Invitation Email(s) dawson.rhett@gmail.com

Heritage Institute of Sustainability LLC

Address 15707C Coit Rd. Suite 133 Participation Type: Active Supplier  
Dallas, TX 75248

Invitation Date 03/12/2021  
Invitation Type Automatic  
Invitation Email(s) info@heritageios.com

Heritage One Roofing, Inc.

Address 3217 Halifax Street Participation Type: Active Supplier  
Dallas, TX 75247

Invitation Date 03/12/2021  
Invitation Type Automatic  
Invitation Email(s) cubsfan10@hotmail.com

HG FIRE SYSTEMS, LP

Address 15102 SOMMERMEYER STREET Participation Type: Active Supplier  
HOUSTON, TX 77041

Classifications WBE (Primary)

Invitation Date 03/12/2021  
Invitation Type Automatic  
Invitation Email(s) T.HERALD@HGFIRE.COM kr.winters@hgfire.com e.shipp@hgfire.com j.bridges@hgfire.com

High Access Solutions

Address 2643 Gravel Drive  
Fort Worth, TX 76118 Participation Type: Active Supplier

Classifications MBE (Primary),WBE

Invitation Date 03/12/2021  
Invitation Type Automatic  
Invitation Email(s) paul@wereachhigh.com

Hilbrick Incorporated

Address 1801 Westlake Drive #108  
West Lake Hills, TX 78746 Participation Type: Active Supplier

Classifications SBE (Primary),HUB

Invitation Date 03/12/2021  
Invitation Type Automatic  
Invitation Email(s) mhilbrick@hilbrick.com

Hill & Wilkinson General Contractors

Address 5810 Trade Center Drive  
Austin, TX 78744 Participation Type: Active Supplier

Invitation Date 03/12/2021  
Invitation Type Automatic  
Invitation Email(s) pharlan@hill-wilkinson.com

Hilti Inc

Address P.O. Box 650756  
Dallas, TX 75265-0756 Participation Type: Active Supplier

Classifications TXM (Primary)

Invitation Date 03/12/2021  
Invitation Type Automatic  
Invitation Email(s) contractadmin@hilti.com

HISD- CTE (Dummy Account)

Address 4400 West 18th  
Houston, TX 77092 Participation Type: Active Supplier

Invitation Date 03/12/2021  
Invitation Type Automatic  
Invitation Email(s) dstrudev@houstonisd.org

HJD Capital Electric, Inc.

Address 5424 Hwy 90 W  
San Antonio, TX 78227 Participation Type: Active Supplier

Invitation Date 03/12/2021  
Invitation Type Automatic  
Invitation Email(s) marketing@hjdcapital.com

HOLES INCORPORATED

Address 9911 Franklin Rd  
Houston, TX 77070 Participation Type: Active Supplier

Classifications SBE (Primary),HUB,WBE

Invitation Date 03/12/2021  
Invitation Type Automatic  
Invitation Email(s) dispatch@holesinc.com

Holtz/Adams Construction and Consulting, LLC

Address P.O. Box 2728 Participation Type: Active Supplier  
Universal City, TX 78148

Invitation Date 03/12/2021  
Invitation Type Automatic  
Invitation Email(s) betsy@holtzadamsconstruction.com

HomeBase Repairs, LLC

Address 926 Robinwood Dr Participation Type: Active Supplier  
Stafford, TX 77477

Classifications MBE (Primary),SBE

Invitation Date 03/12/2021  
Invitation Type Automatic  
Invitation Email(s) manuel@homebaserepairs.com

HOMETOWN HARDWARE (SCHIEL ENTERPRISE INC.)

Address PO BOX 479 Participation Type: Active Supplier  
WALLER, TX 77484

Classifications SBE (Primary),WBE

Invitation Date 03/12/2021  
Invitation Type Automatic  
Invitation Email(s) trishe6288@yahoo.com

Honesty Construction Group (HCG Management LLC)

Address 3102 Brahman Dr Participation Type: Active Supplier  
Manvel, TX 77578

Classifications MBE (Primary),SBE,HUB

Invitation Date 03/12/2021  
Invitation Type Automatic  
Invitation Email(s) gregw@honestycg.com julie@juliehartman.com

Hoodz of Greater Houston & College Station (SparkySpark Inc)

Address 183 Wade Pointe DR Participation Type: Active Supplier  
Montgomery, TX 77316

Invitation Date 03/12/2021  
Invitation Type Automatic  
Invitation Email(s) dan.langdon@hoodz.us.com

Hooper Strategies

Address 515 Davis Rd. Participation Type: Active Supplier  
Granbury, TX 76049

Invitation Date 03/12/2021  
Invitation Type Automatic  
Invitation Email(s) Louise@hooperstrategies.com Les@HooperStrategies.com

Horizon International Group, LLC

Address 4204 Bellaire Blvd. Participation Type: Active Supplier  
Houston, TX 77025

Classifications MBE,TAS,SBE (Primary),HUB,WBE

Invitation Date 03/12/2021  
Invitation Type Automatic  
Invitation Email(s) EMartin@HGIUSA.com edees@hgiusa.com  
Response Date 04/01/2021  
Response Status No Bid  
Status Date 03/12/2021



Horns Crew Trucking (Alvin Horn)

Address 107 B Cherie Ln  
Longview, TX 75604 Participation Type: Active Supplier

Classifications MBE,SBE (Primary),HUB

Invitation Date 03/12/2021  
Invitation Type Automatic  
Invitation Email(s) hornscrew@screw@yahoo.com

Houston Elite Risk Management (T.R. Grace & Company, Inc.)

Address P.O. Box 420458  
Houston, TX 77242 Participation Type: Active Supplier

Invitation Date 03/12/2021  
Invitation Type Automatic  
Invitation Email(s) ngrace@h-erisk.com

Houtex Electric

Address 712 Booth St.  
Houston, TX 77009 Participation Type: Active Supplier

Invitation Date 03/12/2021  
Invitation Type Automatic  
Invitation Email(s) houtexelectric@hotmail.com

Hou-Tex Glass & Mirror Co (Hou Tex Newnom Inc.)

Address 1153 Brittmoore Rd  
Houston, TX 77043 Participation Type: Active Supplier

Invitation Date 03/12/2021  
Invitation Type Automatic  
Invitation Email(s) rick@houtexglass.com

HTX GROUP LLC

Address 11200 FUQUA ST.  
HOUSTON, TX 77089 Participation Type: Active Supplier

Classifications MBE (Primary)

Invitation Date 03/12/2021  
Invitation Type Automatic  
Invitation Email(s) htx\_group@yahoo.com

Hubble Electronics, LLC (Same)

Address 10302 Prospect Hill Dr  
Houston, TX 77064-5414 Participation Type: Active Supplier

Invitation Date 03/12/2021  
Invitation Type Automatic  
Invitation Email(s) Robert@hubbleelectronics.com

Hudson Building Systems

Address 10412 Rockley Road  
Houston, TX 77099 Participation Type: Active Supplier

Invitation Date 03/12/2021  
Invitation Type Automatic  
Invitation Email(s)

Humble Camera Center (Bradley E Crosby)

Address 114 E Main St  
Humble, TX 77338 Participation Type: Active Supplier

Invitation Date 03/12/2021  
Invitation Type Automatic  
Invitation Email(s) brad@humblecamera.com

Hunt and Associates Inc.

Address 4909 E. Grimes Ave, Suite 118 Participation Type: Active Supplier  
Harlingen, TX 78550

Invitation Date 03/12/2021  
Invitation Type Automatic  
Invitation Email(s) KeithF54@aol.com

Hunton Services (HVAC Mechanical Services of Texas LTD)

Address 5622 Luce Street Participation Type: Active Supplier  
Houston, TX 77087

Classifications TCP (Primary)

Invitation Date 03/12/2021  
Invitation Type Automatic  
Invitation Email(s) blecompte@huntongroup.com khardin@huntongroup.com smixon@huntongroup.com  
saguiar@huntongroup.com

Hyc0 Building Maintenance

Address 8301 Braniff ste 102 Participation Type: Active Supplier  
Houston, TX 77061

Invitation Date 03/12/2021  
Invitation Type Automatic  
Invitation Email(s) forrest1@usfacilitytec.com

I/S Mechanical (Inno/lution)

Address 29811 Spring Acres Participation Type: Active Supplier  
Spring, TX 77386

Classifications MBE (Primary),WBE

Invitation Date 03/12/2021  
Invitation Type Automatic  
Invitation Email(s) brandon.markgraf@gmail.com

ICC Thermal Mapping and Data Analytcs (Infrared Concepts Corporation)

Address 465 South Orlando Ave Participation Type: Active Supplier  
Maitland, FL 32825

Classifications SBE (Primary),WBE

Invitation Date 03/12/2021  
Invitation Type Automatic  
Invitation Email(s) mvitaleiccthermal@gmail.com

ICON Diversified, LLC

Address 1909 Woodland Hills Lane Participation Type: Active Supplier  
Weatherford, TX 76087

Classifications SBE (Primary),HUB,WBE

Invitation Date 03/12/2021  
Invitation Type Automatic  
Invitation Email(s) julie.ingram@icondiversified.com  
Response Date 05/03/2021  
Response Status Submitted  
Status Date 05/03/2021

IDG Services, Inc.

Address 1403 TI Blvd. Ste. A Richardson, TX 75081 Participation Type: Active Supplier

Classifications HUB (Primary),WBE

Response Status Unsubmitted  
Status Date 03/23/2021

Idlewood Construction

Address 13721 ALMEDA SCHOOL RD Houston, TX 77047 Participation Type: Active Supplier

Invitation Date 03/12/2021  
Invitation Type Automatic  
Invitation Email(s) tallor@idlewoodconstruction.com

IFS Group Inc.

Address 700 Louisiana Street Houston, TX 77002 Participation Type: Active Supplier

Invitation Date 03/12/2021  
Invitation Type Automatic  
Invitation Email(s) admin@interfsgroup.com

IGH Contracting Services LLC

Address 10107 Erin Glen Way Pearland, TX 77584 Participation Type: Active Supplier

Classifications MBE (Primary)

Invitation Date 03/12/2021  
Invitation Type Automatic  
Invitation Email(s) ighcontracting@yahoo.com

ILCOR Builders (Industrial Laminates Corporation)

Address P.O. Box 9616 Austin, TX 78766 Participation Type: Active Supplier

Classifications TAS,HUB (Primary),WBE

Invitation Date 03/12/2021  
Invitation Type Automatic  
Invitation Email(s) rkelly@ilcor.com kwimbish@ilcor.com

Illinois

Address 100 W. Randolph Chicago, IL 60601 Participation Type: Active Supplier

Invitation Date 03/12/2021  
Invitation Type Manual  
Invitation Email(s)

illumiPure Corp.

Address 14340 Torrey Chase Blvd, Suite 250 Houston, TX 77014 Participation Type: Active Supplier

Invitation Date 03/12/2021  
Invitation Type Automatic  
Invitation Email(s) gina@calyxpure.com steve@calyxpure.com

Imani Quality Concept LLC

Address 3115Washington Blvd  
Beaumont, TX 77705 Participation Type: Active Supplier

Classifications MBE,SBE (Primary),HUB

Invitation Date 03/12/2021  
Invitation Type Automatic  
Invitation Email(s) hardy@imaniqualityconcepts.com

Imbue Cleaning Solutions

Address 2397 Richwood Drive  
Augusta, GA 30906 Participation Type: Active Supplier

Invitation Date 03/12/2021  
Invitation Type Automatic  
Invitation Email(s) Jermezw@imbuecleaning.com

Imperial Construction, Ltd.

Address 193 Coy Road  
Weatherford, TX 76087 Participation Type: Active Supplier

Invitation Date 03/12/2021  
Invitation Type Automatic  
Invitation Email(s) jjones@imperial-construction.com

IMS Dodge

Address 945 Hornblend  
San Diego, CA 92109 Participation Type: Active Supplier

Invitation Date 03/12/2021  
Invitation Type Automatic  
Invitation Email(s) cawr@imsinfo.com

Indiana

Address 402 W Washington St  
Indianapolis, IN 46204 Participation Type: Active Supplier

Invitation Date 03/12/2021  
Invitation Type Manual  
Invitation Email(s)

INFINITY CONTRACTORS INT'L LTD

Address 2563 E LOOP 820 N  
FORT WORTH, TX 76118 Participation Type: Active Supplier

Invitation Date 03/12/2021  
Invitation Type Automatic  
Invitation Email(s) JBSALTER@INFINITYCONTRACTORS.COM

InnovsiteLLC

Address 2773 white oak drive  
Decatur, GA 30032 Participation Type: Active Supplier

Classifications MBE (Primary),SBE

Invitation Date 03/12/2021  
Invitation Type Automatic  
Invitation Email(s) hakim@innovsite.com

Institute for Building Technology and Safety

Address 45207 Research Place  
VA, VA 20147 Participation Type: Active Supplier

Invitation Date 03/12/2021  
Invitation Type Automatic  
Invitation Email(s) cmiller@ibts.org

Integrity Pipeline Services

Address P.O. Box 583  
Pearland, TX 77588 Participation Type: Active Supplier

Invitation Date 03/12/2021  
Invitation Type Automatic  
Invitation Email(s) candybrantley@sbcglobal.net

Interfacing Company of Texas

Address 14850 Woodham  
Houston, TX 77073 Participation Type: Active Supplier

Classifications MBE,SBE (Primary),WBE

Invitation Date 03/12/2021  
Invitation Type Automatic  
Invitation Email(s) acct@ictxwavemedia.net glenn.brooks@ictxwavemedia.net info@ictxwavemedia.net  
terrell.hubenak@ictxwavemedia.net

INTERNATIONAL PROPERTY DEVELOPMENTS LLC DBA THE SIGNITURE GROUP

Address 346 Twin City Hwy  
Port Neches, TX 77651-6203 Participation Type: Active Supplier

Classifications SBE (Primary)

Invitation Date 03/12/2021  
Invitation Type Automatic  
Invitation Email(s) ccosca@ts-grp.com

Interprise/Southwest Interior & Space Planning, In

Address 5080 Spectrum Dr  
Addison, TX 75001 Participation Type: Active Supplier

Classifications SBE (Primary),WBE

Invitation Date 03/12/2021  
Invitation Type Automatic  
Invitation Email(s)

Interstate Restoration LLC

Address 3401 Quorum Dr  
Fort Worth, TX 76137 Participation Type: Active Supplier

Invitation Date 03/12/2021  
Invitation Type Automatic  
Invitation Email(s) khartz@interstaterestoration.com

Ion Wave Support

Address 3653 South Ave  
Springfield, MO 65807 Participation Type: Active Supplier

Response Status Viewed  
Status Date 05/07/2021

Iowa State

Address 321 East 12th Street  
Des Moines, IA 50319 Participation Type: Active Supplier

Invitation Date 03/12/2021  
Invitation Type Manual  
Invitation Email(s)

I-Raos, Inc

Address 8765 Orchard View Lane Participation Type: Active Supplier  
Pearland, TX 77584

Invitation Date 03/12/2021  
Invitation Type Automatic  
Invitation Email(s) prabha.radhakrishnan@iraos.net

ISES Corporation

Address 3100 Breckinridge Blvd. Participation Type: Active Supplier  
Duluth, GA 30087

Classifications MBE (Primary),SBE

Invitation Date 03/12/2021  
Invitation Type Automatic  
Invitation Email(s) RobG@isescorp.com MaryjaneS@isescorp.com

iSqFt® and Houston AGC plan room

Address 8450 WestPark Participation Type: Active Supplier  
Houston, TX 77063

Invitation Date 03/12/2021  
Invitation Type Automatic  
Invitation Email(s)

IT Installs (BBSC Corp)

Address 4731 Malory Place Participation Type: Active Supplier  
Sarasota, FL 34241

Invitation Date 03/12/2021  
Invitation Type Automatic  
Invitation Email(s) bud@it-installs.com

J C Currey

Address 200 S Alto Mesa Participation Type: Active Supplier  
El Paso, TX 79912

Invitation Date 03/12/2021  
Invitation Type Automatic  
Invitation Email(s) jcurrey@aol.com

J Frank Consulting (Joan Frank)

Address 105 CR 530 Participation Type: Active Supplier  
Fairfield, TX 75840

Classifications WBE (Primary)

Invitation Date 03/12/2021  
Invitation Type Automatic  
Invitation Email(s) jfsartin@gmail.com

J Reynolds & Co., Inc.

Address 369 Sansom Blvd. Participation Type: Active Supplier  
Saginaw, TX 76179

Classifications TIP (Primary)

Invitation Date 03/12/2021  
Invitation Type Automatic  
Invitation Email(s) clint@jreynolds.com mskipper@jreynolds.com

J THOMAS II CONSTRUCTION, LLC

Address 325 N Hancock St  
Angleton, TX 77515 Participation Type: Active Supplier

Classifications MBE (Primary),SBE,HUB,WBE

Invitation Date 03/12/2021  
Invitation Type Automatic  
Invitation Email(s) jtii1construction@gmail.com

J&E Associates (JE Specialities)

Address 6031 South Loop East  
Houston, TX 77033 Participation Type: Active Supplier

Classifications MBE (Primary),HUB

Invitation Date 03/12/2021  
Invitation Type Automatic  
Invitation Email(s) latonyas@je-assoc.com

J.L. Squared Construction

Address P.O. Box 10376  
Corpus Christi, TX 78460 Participation Type: Active Supplier

Classifications HUB (Primary)

Response Date 05/07/2021  
Response Status Submitted  
Status Date 05/07/2021

J.S. Electric, Inc.

Address 4702 FM 1327  
Buda, TX 78610 Participation Type: Active Supplier

Classifications MBE (Primary),SBE,HUB,WBE

Invitation Date 03/12/2021  
Invitation Type Automatic  
Invitation Email(s) jschmidt@jselectric.com

J2 General, LLC

Address P.O. Box 1028  
Cedar Park, TX 78630 Participation Type: Active Supplier

Invitation Date 03/12/2021  
Invitation Type Automatic  
Invitation Email(s) jrider@J2general.com

JABG Construction & Engineer (Thomas 11 Development LLC)

Address 938 kirnwood dr  
Dallas, TX 75232 Participation Type: Active Supplier

Invitation Date 03/12/2021  
Invitation Type Automatic  
Invitation Email(s) Jabgconstruction@engineer.com

Jahmor Janitorial Services

Address 3814 Goulburn  
Houston, TX 77045 Participation Type: Active Supplier

Invitation Date 03/12/2021  
Invitation Type Automatic  
Invitation Email(s) dsmith@jahmorenterprise.com

Jamail & Smith Construction, LP

Address 8868 Research Blvd. Participation Type: Active Supplier  
Austin, TX 78758

Classifications TAS (Primary),TCP,TXM

Invitation Date 03/12/2021  
Invitation Type Automatic  
Invitation Email(s) gsmith@jamailsmith.com

JAMCO ELECTRICAL (JESUS TREVINO)

Address 12707 DE FORREST ST Participation Type: Active Supplier  
HOUSTON, TX 77066

Classifications MBE (Primary),SBE

Invitation Date 03/12/2021  
Invitation Type Automatic  
Invitation Email(s) jtrevino@jamcoelectrical.com

Jarrar & Company, Inc.

Address 9119 Emmott Road Participation Type: Active Supplier  
Houston, TX 77040

Invitation Date 03/12/2021  
Invitation Type Automatic  
Invitation Email(s) jjarrar@jarrarandcompany.com

JAX CONSTRUCTION

Address 7021 MILE 7 1/2 RD Participation Type: Active Supplier  
MISSION, TX 78573

Invitation Date 03/12/2021  
Invitation Type Automatic  
Invitation Email(s)

Jaymark Engineering Corporation

Address 3730 Cypress Creek Parkway, Suite 108 Participation Type: Active Supplier  
Houston, TX 77068

Classifications MBE,SBE (Primary),HUB

Invitation Date 03/12/2021  
Invitation Type Automatic  
Invitation Email(s) mdt@jaymarkengineering.com

JBRI Construction Services, LLC

Address P.O.Box 147 Participation Type: Active Supplier  
Pinehurst, TX 77362

Invitation Date 03/12/2021  
Invitation Type Automatic  
Invitation Email(s) jbriservices@yahoo.com

JC Stonewall Constructors, LP

Address 11210 Steeplecrest Drive Participation Type: Active Supplier  
Houston, TX 77065

Invitation Date 03/12/2021  
Invitation Type Automatic  
Invitation Email(s) jcolwell@stonewallconstructors.com



JEFF EUBANK ROOFING CO., INC.

Address 1900 Northpark Drive  
Fort Worth, TX 76102 Participation Type: Active Supplier

Classifications SBE (Primary)

Invitation Date 03/12/2021  
Invitation Type Automatic  
Invitation Email(s) jhe@eubankroofing.com

Jeffrey's Landscaping

Address 636 N Ed Carey Dr. STE 300  
Harlingen, TX 78552 Participation Type: Active Supplier

Classifications MBE (Primary)

Invitation Date 03/12/2021  
Invitation Type Automatic  
Invitation Email(s) ydiaz5830@gmail.com

Jeff's Mechanical Service

Address 123 Test avenue  
Houston, TX 77055 Participation Type: Active Supplier

Classifications HUB (Primary)

Response Status Unsubmitted  
Status Date 04/13/2021

JEGAS Construction

Address PO Box 25183  
Houston, TX 77265 Participation Type: Active Supplier

Invitation Date 03/12/2021  
Invitation Type Automatic  
Invitation Email(s)

JERICHO FOUNDATION REPAIR

Address 9430 WHITE CHAPEL  
HOUSTON, TX 77074 Participation Type: Active Supplier

Invitation Date 03/12/2021  
Invitation Type Automatic  
Invitation Email(s)

JESCO Environmental & Geotechnical Services

Address 1701 S. Thibodeaux Rd.  
Jennings, LA 70546 Participation Type: Active Supplier

Classifications WBE (Primary)

Invitation Date 03/12/2021  
Invitation Type Automatic  
Invitation Email(s) lfontenot@jesous.com

Jet Industrial Service Group

Address 23264 IH 10  
Vidor, TX 77662 Participation Type: Active Supplier

Invitation Date 03/12/2021  
Invitation Type Automatic  
Invitation Email(s) c.townley@jetisg.com

Jim E Owens, Facilities Consulting, LLC

Address 15508 Avenue C  
Channelview, TX 77530-4024 Participation Type: Active Supplier

Classifications SBE (Primary)

Invitation Date 03/12/2021  
Invitation Type Automatic  
Invitation Email(s) jeowens@me.com

Jimtex Electric LLC

Address 11215 Jones Rd West Suite H  
Houston, TX 77065 Participation Type: Active Supplier

Classifications SBE,HUB (Primary)

Invitation Date 03/12/2021  
Invitation Type Automatic  
Invitation Email(s) jj@jimtexelectric.com

JKAJ SERVICE CORP, LLC

Address 16103 Queensdale Dr.  
Houston, TX 77082 Participation Type: Active Supplier

Invitation Date 03/12/2021  
Invitation Type Automatic  
Invitation Email(s) jkajservice@outlook.com

JLA Construction Solutions

Address 15825 SH249  
Houston, TX 77086 Participation Type: Active Supplier

Classifications MBE (Primary),SBE,HUB

Invitation Date 03/12/2021  
Invitation Type Automatic  
Invitation Email(s) john@jlacs.net

JLL (Jones Lang LaSalle, Americas, Inc.)

Address 1400 Post Oak Boulevard  
Houston, TX 77056 Participation Type: Active Supplier

Invitation Date 03/12/2021  
Invitation Type Automatic  
Invitation Email(s)

JM Construction Solutions (JM Management LLC)

Address 1937 Irving Blvd.  
Dallas, TX 75207 Participation Type: Active Supplier

Invitation Date 03/12/2021  
Invitation Type Automatic  
Invitation Email(s) pompeyo@jmconsol.com

JM Sales & Services

Address P O Box 16851  
Galveston, TX 77552 Participation Type: Active Supplier

Invitation Date 03/12/2021  
Invitation Type Automatic  
Invitation Email(s) jack\_muecke@yahoo.com

JNJ RESURFACING DBA (JUAN JESUS ZAMORA)

---

Address PO BOX 630662 Participation Type: Active Supplier  
HOUSTON, TX 77263

Classifications MBE (Primary)

Invitation Date 03/12/2021  
Invitation Type Automatic  
Invitation Email(s) jnjresurfacing@yahoo.com

Jon M. Warren, LLC

---

Address 122 Private Road 3005 Participation Type: Active Supplier  
Decatur, TX 76234

Classifications DIR,HUB (Primary)

Invitation Date 03/12/2021  
Invitation Type Automatic  
Invitation Email(s) jon@jonwarren.net

Jones Lang LaSalle (JLL)

---

Address 1400 Post Oak Blvd Participation Type: Active Supplier  
Houston, TX 77056

Invitation Date 03/12/2021  
Invitation Type Automatic  
Invitation Email(s) sundaresh.kamath@am.jll.com

Jonmar Electric, Inc.

---

Address PO Box 1771 Participation Type: Active Supplier  
Bellaire, TX 77402

Invitation Date 03/12/2021  
Invitation Type Automatic  
Invitation Email(s) jgilroy@jonmar.com

Jorrie Martin LLC

---

Address 4407 Walzem Road, Suite 210 Participation Type: Active Supplier  
San Antonio, TX 78218

Classifications MBE,SBE (Primary)

Invitation Date 03/12/2021  
Invitation Type Automatic  
Invitation Email(s)

Journeys Managing Group LLC

---

Address 16231 Charterstone Dr Participation Type: Active Supplier  
Houston, TX 77070

Classifications MBE (Primary),SBE,HUB,WBE

Invitation Date 03/12/2021  
Invitation Type Automatic  
Invitation Email(s) admin@journeysmanaginggroup.com

JR Thomas Group, Inc.

---

Address 2019 Wichita St Participation Type: Active Supplier  
Houston, TX 77004

Invitation Date 03/12/2021  
Invitation Type Automatic  
Invitation Email(s) jthomas@tgmhouston.com kimw@tgmhouston.com

JSHardfy, llc

Address 11111 Grant Road  
Cypress, TX 77429 Participation Type: Active Supplier

Classifications SBE (Primary)

Invitation Date 03/12/2021  
Invitation Type Automatic  
Invitation Email(s) steve@jshardy.com

JUST CONSTRUCTION

Address 4241 Purdue Street  
Houston, TX 77005 Participation Type: Active Supplier

Invitation Date 03/12/2021  
Invitation Type Automatic  
Invitation Email(s) justconstruction14@gmail.com

Jv-janitorial

Address 5805 tackett ct  
Fortworth, TX 76112 Participation Type: Active Supplier

Invitation Date 03/12/2021  
Invitation Type Automatic  
Invitation Email(s) j\_vjanitorial@yahoo.com

K & S Contracting, Inc

Address 17639 Telge Road  
Cypress, TX 77429 Participation Type: Active Supplier

Invitation Date 03/12/2021  
Invitation Type Automatic  
Invitation Email(s) kim@kscont.com

K S Restoration, Inc.

Address P. O. Box 182522  
Arlington, TX 76096 Participation Type: Active Supplier

Classifications MBE,SBE,HUB (Primary),WBE

Invitation Date 03/12/2021  
Invitation Type Automatic  
Invitation Email(s) ksrestoration@yahoo.com

K.R. Allen Industrial Services, LLC (K.R. Allen Construction, LLC)

Address P.O. Box 9198  
Bacliff, TX 77518 Participation Type: Active Supplier

Classifications TIP,SBE (Primary)

Invitation Date 03/12/2021  
Invitation Type Automatic  
Invitation Email(s)

Kaiser International, Inc

Address Kaiser Graphics  
Houston, TX 77060 Participation Type: Active Supplier

Response Date 05/07/2021  
Response Status Submitted  
Status Date 05/07/2021

KANKO (Floyd's Chores & Odd Jobs)

Address 2031 Cedar Valley  
Dallas, TX 75232 Participation Type: Active Supplier

Invitation Date 03/12/2021  
Invitation Type Automatic  
Invitation Email(s) kankobidops@gmail.com

Kansas

Address 1000 SW Jackson St  
Topeka, KS 66612 Participation Type: Active Supplier

Invitation Date 03/12/2021  
Invitation Type Manual  
Invitation Email(s)

Kendnel Kasper Construction

Address 162 Linda Dr.  
Fredericksburg, TX 78624 Participation Type: Active Supplier

Classifications SBE (Primary)

Invitation Date 03/12/2021  
Invitation Type Automatic  
Invitation Email(s) dite@stx.rr.com

Kentech Inc.

Address 21855 E. Hammond Dr.  
Porter, TX 77365 Participation Type: Active Supplier

Classifications HGA,HUB,WBE (Primary)

Invitation Date 03/12/2021  
Invitation Type Automatic  
Invitation Email(s) bthompson@kentechpower.com

Kes Maid llc

Address 2133 New cut rd  
Spartanburg, SC 29303 Participation Type: Active Supplier

Classifications MBE (Primary)

Invitation Date 03/12/2021  
Invitation Type Automatic  
Invitation Email(s) cmakupson6@gmail.com

Key HTX Development & Holdings

Address 315 W. Alabama STE 104  
HOUSTON, TX 77006 Participation Type: Active Supplier

Classifications MBE (Primary),SBE

Invitation Date 03/12/2021  
Invitation Type Automatic  
Invitation Email(s) kdale@key-htx.com

Key Installations LLC

Address 1102 Misty Way  
Crosby, TX 77532 Participation Type: Active Supplier

Invitation Date 03/12/2021  
Invitation Type Automatic  
Invitation Email(s) keith@keyinstallations.com

KIKO Construction (KIKOCon, Inc.)

Address 738 Washington Circle Participation Type: Active Supplier  
Harlingen, TX 78550

Classifications MBE,SBE (Primary)

Invitation Date 03/12/2021  
Invitation Type Automatic  
Invitation Email(s) vlozano.kikocon@gmail.com

Kilgore Industries

Address 10050 Houston Oaks Drive Participation Type: Active Supplier  
Houston, TX 77064

Invitation Date 03/12/2021  
Invitation Type Automatic  
Invitation Email(s) malaimo@kilgoreind.com

Kingham Dalton Wilson, Ltd.

Address 5858 Westheimer Participation Type: Active Supplier  
Houston, TX 77057

Invitation Date 03/12/2021  
Invitation Type Automatic  
Invitation Email(s) gweidemeyer@kdwLtd.com

Kitchell Contractors

Address 9020 Capital of Texas Hwy, Suite I-180 Participation Type: Active Supplier  
Austin, TX 78759

Invitation Date 03/12/2021  
Invitation Type Automatic  
Invitation Email(s) mkraus@kitchell.com tlee@kitchell.com ksimon@kitchell.com

Kitchen rescue

Address 3905 Kristencreek Lane Participation Type: Active Supplier  
Round Rock, TX 78681

Classifications MBE (Primary),SBE

Invitation Date 03/12/2021  
Invitation Type Automatic  
Invitation Email(s) robertcole2147@yahoo.com

Kiwi Services

Address 2245 Keller Way Participation Type: Active Supplier  
Carrollton, TX 75006

Invitation Date 03/12/2021  
Invitation Type Automatic  
Invitation Email(s) sales@kiwiservices.com

Kline Technical Consulting, LLC

Address 6106 Amberly Place Participation Type: Active Supplier  
Austin, TX 78759

Classifications SBE (Primary)

Invitation Date 03/12/2021  
Invitation Type Automatic  
Invitation Email(s) rkline@klinenm.com

KMD Hospitality (KMD Hospitality LLC)

Address 10706 Kentington Oak Drive Participation Type: Active Supplier  
Humble, TX 77396

Classifications MBE,SBE (Primary),WBE

Invitation Date 03/12/2021  
Invitation Type Automatic  
Invitation Email(s) karen@kmdhospitality.com annette@kmdhospitality.com

Knight Restoration Services

Address 4200 Sojourn Dr Participation Type: Active Supplier  
Addison, TX 75001

Invitation Date 03/12/2021  
Invitation Type Automatic  
Invitation Email(s) David@knightrestoration.com

KQC Investors, LLC

Address 1310 Lewisville Clemmons Participation Type: Active Supplier  
Lewisville, NC 27023

Invitation Date 03/12/2021  
Invitation Type Automatic  
Invitation Email(s) rwaddell@kaplanco.com

KR Allen Construction, LLC

Address Post Office Box 9198 Participation Type: Active Supplier  
Bacliff, TX 77518

Classifications SBE (Primary)

Invitation Date 03/12/2021  
Invitation Type Automatic  
Invitation Email(s) larry@krallen.net

Kriston Construction Company Inc

Address P O Box 429 Participation Type: Active Supplier  
Beaumont, TX 77704

Invitation Date 03/12/2021  
Invitation Type Automatic  
Invitation Email(s) harrykilgore@kristonconstruction.com

L&S Associates, LLC

Address 135 Victoria Drive E Participation Type: Active Supplier  
Montgomery, TX 77356

Invitation Date 03/12/2021  
Invitation Type Automatic  
Invitation Email(s) gllookabaugh@yahoo.com

L.D. Bundren Painting, Inc.

Address 26110 Longenbaugh Rd. Participation Type: Active Supplier  
Katy, TX 77493

Invitation Date 03/12/2021  
Invitation Type Automatic  
Invitation Email(s) mfiorenza@bundrenpainting.com estimating@bundrenpainting.com

Lady Liberty Group LLC

Address 722 West Eules Blvd.  
Eules, TX 76040 Participation Type: Active Supplier

Classifications MBE,SBE,HUB (Primary),WBE

Invitation Date 03/12/2021  
Invitation Type Automatic  
Invitation Email(s) d@ladylibertygroup.com

Lake Air Interiors (Focused Contractor Services)

Address 503 Lake Air Drive  
Waco, TX 76710 Participation Type: Active Supplier

Invitation Date 03/12/2021  
Invitation Type Automatic  
Invitation Email(s) Vbourque@fcs-waco.com

Landmarc Holding, LLC

Address 6420 Southwest Blvd. | Suite 206  
Forth Worth, TX 76109 Participation Type: Active Supplier

Classifications SBE (Primary)

Invitation Date 03/12/2021  
Invitation Type Automatic  
Invitation Email(s) dkaptur@anchorconstruction.com

Landmark Electric Company (Landmark Electric Co.)

Address 4033 Bradford  
Corpus Christi, TX 78411 Participation Type: Active Supplier

Invitation Date 03/12/2021  
Invitation Type Automatic  
Invitation Email(s)

Landscape Management Services (LMS Inc.)

Address 11721 North Garden Street  
Houston, TX 77071 Participation Type: Active Supplier

Invitation Date 03/12/2021  
Invitation Type Automatic  
Invitation Email(s)

Lange Mechanical Services, L.P.

Address 933 Wakefield Drive  
Houston, TX 77018 Participation Type: Active Supplier

Invitation Date 03/12/2021  
Invitation Type Automatic  
Invitation Email(s) BRamos@langemechanical.com  
Response Status Viewed  
Status Date 05/07/2021

LanMarc Construction (Marti M. Carder)

Address 206 S. Columbia Dr.  
West Columbia, TX 77486 Participation Type: Active Supplier

Classifications SBE (Primary),WBE

Invitation Date 03/12/2021  
Invitation Type Automatic  
Invitation Email(s) marti@lanmarcgc.com



LaTx Construction Services

Address 2412 1/2 Arbor st  
Houston, TX 77004 Participation Type: Active Supplier

Invitation Date 03/12/2021  
Invitation Type Automatic  
Invitation Email(s) latxconstructionservices@gmail.com

Launch Point CDC, Inc.

Address 5807 Little York  
Houston, TX 77016 Participation Type: Active Supplier

Classifications MBE (Primary),SBE,HUB,WBE

Invitation Date 03/12/2021  
Invitation Type Automatic  
Invitation Email(s) imayhorn@yahoo.com

Lawnsapes Unlimited

Address PO BOX 553  
Rosharon, TX 77583 Participation Type: Active Supplier

Invitation Date 03/12/2021  
Invitation Type Automatic  
Invitation Email(s) jason@lawnsapesunlimited.com

LBNM Corporation

Address 9003 Clearwater Ranch Ln  
Richmond, TX 77407 Participation Type: Active Supplier

Classifications MBE (Primary),SBE,HUB

Invitation Date 03/12/2021  
Invitation Type Automatic  
Invitation Email(s) tbakare@lbnm-corp.com

LD Tebben Company, Inc.

Address 4315 Terry-O Ln  
Austin, TX 78745-1241 Participation Type: Active Supplier

Classifications SBE (Primary)

Invitation Date 03/12/2021  
Invitation Type Automatic  
Invitation Email(s) tomfleitz@austin.rr.com Jack@ldtebben.com

LDG Facility Services LLC

Address 11011 Brooklet Dr. Suite 200  
Houston, TX 77099 Participation Type: Active Supplier

Invitation Date 03/12/2021  
Invitation Type Automatic  
Invitation Email(s) dale@ldgfacilityservices.com

Learn, Play and Discover Academy

Address 15110 FM 2100 #1  
Crosby, TX 77532 Participation Type: Active Supplier

Classifications WBE (Primary)

Invitation Date 03/12/2021  
Invitation Type Automatic  
Invitation Email(s) lpda15110@yahoo.com

Leather Only Products

---

Address 9220 Summerbell Lane Participation Type: Active Supplier  
Houston, TX 77074

Classifications SBE (Primary)

Invitation Date 03/12/2021  
Invitation Type Automatic  
Invitation Email(s) cn@leatheronlyproducts.com

Lee Services Inc.

---

Address P. O. Box 1053 Participation Type: Active Supplier  
New Caney, TX 77357

Invitation Date 03/12/2021  
Invitation Type Automatic  
Invitation Email(s) jennifer@leeservicesinc.com

Lessman Roofing and Sheet Meda

---

Address 113 Rhodes St G and H Participation Type: Active Supplier  
Conroe, TX 77301

Invitation Date 03/12/2021  
Invitation Type Automatic  
Invitation Email(s) amy@lessmanroofing.com

level C 3 Construction

---

Address 16518 east kingscoate drive Participation Type: Active Supplier  
crosby, TX 77532

Classifications MBE,SBE (Primary),HUB,WBE

Invitation Date 03/12/2021  
Invitation Type Automatic  
Invitation Email(s) cmcnabb@level3c-construction.com

Level Infrastructure LLC

---

Address 6100 Richmond ave #224 Participation Type: Active Supplier  
Houston, TX 77057

Classifications MBE,SBE (Primary),HUB

Invitation Date 03/12/2021  
Invitation Type Automatic  
Invitation Email(s)

Levys On The Run Landscaping & Janitorial Services LLC

---

Address 11752 south harrells ferry rd ste F Participation Type: Active Supplier  
baton rouge, LA 70819

Invitation Date 03/12/2021  
Invitation Type Automatic  
Invitation Email(s) levysontherun@outlook.com

Levy's Tutorial and Enrichment Center (Mary Baumann)

---

Address 4814 Burma Rd Participation Type: Active Supplier  
Houston, TX 77033

Classifications MBE (Primary),SBE,WBE

Response Date 04/01/2021  
Response Status No Bid  
Status Date 04/01/2021

Lighthouse Construction, LLC

Address P.O. Box 160 Participation Type: Active Supplier  
Burnet, TX 78611

Invitation Date 03/12/2021  
Invitation Type Automatic  
Invitation Email(s) nlighthouseconstruction@aol.com

Lime Energy (Texas Energy Products Inc)

Address 7801 N. Lamar Blvd., Suite C63 Participation Type: Active Supplier  
Austin, TX 78752

Invitation Date 03/12/2021  
Invitation Type Automatic  
Invitation Email(s)

Linc Service, LLC

Address 11710 N. Freeway Participation Type: Active Supplier  
Houston, TX 77060

Invitation Date 03/12/2021  
Invitation Type Automatic  
Invitation Email(s) jim.nix@thelincgroup.com

Lindsey Electric, L.P.

Address 823 Thornton Rd Participation Type: Active Supplier  
Houston, TX 77018

Invitation Date 03/12/2021  
Invitation Type Automatic  
Invitation Email(s) ccaldwell@nhplc.com

Link Staffing Services (Stafflink, Inc.)

Address 12097 Old Hammond Hwy., Ste. E-1 Participation Type: Active Supplier  
Baton Rouge, LA 70816

Invitation Date 03/12/2021  
Invitation Type Automatic  
Invitation Email(s)

LMC Corp (Lee Construction and Maintenance)

Address 9191 Winkler Dr. A Participation Type: Active Supplier  
Houston, TX 77017

Classifications MBE,TAS,SBE (Primary),HUB

Invitation Date 03/12/2021  
Invitation Type Automatic  
Invitation Email(s) david.maxwell@lmc-corporation.com emily.gorham@lmccorp.net ewauters@lmccorp.net jlee@lmccorp.net  
Response Date 05/07/2021  
Response Status Submitted  
Status Date 05/07/2021

LMS Commercial Services (LMS Restoration)

Address 925 Texas Highway 24 Participation Type: Active Supplier  
Paris, TX 75462

Classifications TAS (Primary),TIP

Invitation Date 03/12/2021  
Invitation Type Automatic  
Invitation Email(s) valerie@lmscommercialservices.com

Lockwood, Andrews & Newnam, Inc.

Address 2925 Briarpark Drive Participation Type: Active Supplier  
Houston, TX 77042

Invitation Date 03/12/2021  
Invitation Type Automatic  
Invitation Email(s) bgvendoropportunities@lan-inc.com

Logical Solutions, Inc

Address 407 International Parkway Participation Type: Active Supplier  
Richardson, TX 75081

Invitation Date 03/12/2021  
Invitation Type Automatic  
Invitation Email(s) DSepich@LSiControls.com jbarber@lsicontrols.com

Logistical Concepts LLC

Address 5830 Shirley Lane Participation Type: Active Supplier  
Humble, TX 77396

Classifications MBE (Primary)

Invitation Date 03/12/2021  
Invitation Type Automatic  
Invitation Email(s)

Logistical Maintenance

Address 4618 Merchant Springs lane Participation Type: Active Supplier  
Houston, TX 77084

Invitation Date 03/12/2021  
Invitation Type Automatic  
Invitation Email(s) ahmet.sehic.harmony@gmail.com

Lone Star Waterproofing Inc

Address 2217 Hinton Drive Participation Type: Active Supplier  
Irving, TX 75061

Classifications SBE (Primary)

Invitation Date 03/12/2021  
Invitation Type Automatic  
Invitation Email(s) terrymaitland@hotmail.com

LongCrete (Longhill Group, Inc.)

Address 4110 Trey Lane Participation Type: Active Supplier  
Argyle, TX 76226

Invitation Date 03/12/2021  
Invitation Type Automatic  
Invitation Email(s) chrisl@longcrete.com

Lorraine Construction, Inc.

Address 1805 E. Mulberry St. Participation Type: Active Supplier  
Angleton, TX 77515

Invitation Date 03/12/2021  
Invitation Type Automatic  
Invitation Email(s) stuartl@lorraineconst.com

Lowe's Companies Inc

Address 1000 Lowe's Blvd Participation Type: Active Supplier  
 Mooresville, NC 28117

Invitation Date 03/12/2021  
Invitation Type Automatic  
Invitation Email(s)

L-Sync, LLC

Address 2911 Mirado  
Grand Prairie, TX 75054 Participation Type: Active Supplier

Invitation Date 03/12/2021  
Invitation Type Automatic  
Invitation Email(s) joe.james@l-sync.com

Luchazie Construction (Luchazie General Store and Restaurant dba Luchazie Construction)

Address 1023 East State HWY 44  
San Diego, TX 78384 Participation Type: Active Supplier

Invitation Date 03/12/2021  
Invitation Type Automatic  
Invitation Email(s) luchazie@yahoo.com

LUMAR Ventures (Luis M Dueno Medina)

Address 3415 River Way  
San Antonio, TX 78230 Participation Type: Active Supplier

Classifications MBE (Primary),SBE

Invitation Date 03/12/2021  
Invitation Type Automatic  
Invitation Email(s) ldueno@att.net

LVC Technologies, LLC

Address 7606 Lakeshore Point Lane  
Rosenberg, TX 77469 Participation Type: Active Supplier

Invitation Date 03/12/2021  
Invitation Type Automatic  
Invitation Email(s) nick@lvctech.com august@lvctech.com

Lynx Contractors, Inc.

Address 2626 Hunter Road, Suite 104  
San Marcos, TX 78666 Participation Type: Active Supplier

Classifications SBE (Primary)

Response Status Viewed  
Status Date 04/29/2021

M SPACE (M Space Holdings, LLC)

Address 629 Parkway Drive  
Park City, UT 84098 Participation Type: Active Supplier

Classifications HGA (Primary),TCP,TIP

Invitation Date 03/12/2021  
Invitation Type Automatic  
Invitation Email(s) Leads@mspaceholdings.com

M&H Lighting Systems (Mapenzi Group)

Address 706 Maple Branch Ln  
Pearland, TX 77584 Participation Type: Active Supplier

Classifications MBE (Primary)

Invitation Date 03/12/2021  
Invitation Type Automatic  
Invitation Email(s) wmartin@mhlightingsystems.com

Macias Constructions, LLC

Address 15754 Sweetwater Creek Dr Participation Type: Active Supplier  
Houston, TX 77095

Classifications MBE,SBE,HUB (Primary)

Invitation Date 03/12/2021  
Invitation Type Automatic  
Invitation Email(s) macias\_constructions@hotmail.com

MAF ENTERPRISES, INC.

Address 7830 LETTIE Participation Type: Active Supplier  
HOUSTON, TX 77075

Classifications SBE,HUB (Primary),WBE

Invitation Date 03/12/2021  
Invitation Type Automatic  
Invitation Email(s) MELISSA@MAF1998.COM

MAGIC ONE SERVICES LLC

Address 18 Summithill Place Participation Type: Active Supplier  
Spring, TX 77381

Invitation Date 03/12/2021  
Invitation Type Automatic  
Invitation Email(s) gabe@magic1services.com

Magnum Air Inc

Address 15498 Summit Park Dr. Ste.101 Participation Type: Active Supplier  
Montgomery, TX 77356

Invitation Date 03/12/2021  
Invitation Type Automatic  
Invitation Email(s) wfincher@magnumairinc.com

MainStage Theatrical Supply

Address 8761A Ely Road Participation Type: Active Supplier  
Pensacola, FL 32514

Invitation Date 03/12/2021  
Invitation Type Automatic  
Invitation Email(s) mainstagesales@gmail.com

Majestik Industries, L.L.C.

Address 1100 Wilson Ct. Participation Type: Active Supplier  
Humble, TX 77396

Invitation Date 03/12/2021  
Invitation Type Automatic  
Invitation Email(s) travis@majestikllc.com

Major League Roofing

Address 3245 Main Street Participation Type: Active Supplier  
Frisco, TX 75034

Invitation Date 03/12/2021  
Invitation Type Automatic  
Invitation Email(s)

Mako Industries (Mako Olifield Services DBA Mako Industries)

Address 12249-B Northwoods Park Drive Participation Type: Active Supplier  
Houston, TX 77041

Invitation Date 03/12/2021  
Invitation Type Automatic  
Invitation Email(s) ejohnson@makoind.com

Maldonado Nursery & Landscaping, Inc.

Address 16348 Nacogdoches San Antonio, TX 78247 Participation Type: Active Supplier

Classifications MBE (Primary),TPA,HUB

Invitation Date 03/12/2021  
Invitation Type Automatic  
Invitation Email(s) richardw@mnlsa.com Sales@mnlsa.com Rogerm@mnlsa.com

Mammoth Roofing Services (Mammoth Services, LLC)

Address 2045 Space Park Dr. Suite 290 Houston, TX 77058 Participation Type: Active Supplier

Classifications MBE (Primary),SBE,HUB,WBE

Invitation Date 03/12/2021  
Invitation Type Automatic  
Invitation Email(s) Trisha@usmammoth.com

Marcis & Associates, Inc.

Address P. O. Box 11175 Spring, TX 77391-1175 Participation Type: Active Supplier

Classifications MBE,TIP,SBE,HUB (Primary)

Invitation Date 03/12/2021  
Invitation Type Automatic  
Invitation Email(s) jcisneros@marcis.net

Mark Collins Construction LLC

Address P.O. Box 1476 League City, TX 77574 Participation Type: Active Supplier

Invitation Date 03/12/2021  
Invitation Type Automatic  
Invitation Email(s) info@clearlakecontractor.com

Marksmen General Contractors, Inc.

Address 24165 IH-10 W., Ste. 217-744 San Antonio, TX 78257 Participation Type: Active Supplier

Invitation Date 03/12/2021  
Invitation Type Automatic  
Invitation Email(s) mandyb@marksmengc.com

Marles enerprises, LLC

Address 18 Sawyer Brook Circle South Portland, ME 04106 Participation Type: Active Supplier

Classifications SBE (Primary)

Invitation Date 03/12/2021  
Invitation Type Automatic  
Invitation Email(s) gm@marles.net

Marseal Group

Address 105 Denton Drive Roanoke, TX 76262 Participation Type: Active Supplier

Classifications HUB (Primary)

Invitation Date 03/12/2021  
Invitation Type Automatic  
Invitation Email(s) jroth@marsealgroup.com

Marsh Waterproofing, Inc

Address 240 South Main Ste #2 Participation Type: Active Supplier  
Vidor, TX 77662

Classifications HUB,WBE (Primary)

Invitation Date 03/12/2021  
Invitation Type Automatic  
Invitation Email(s) mwaterproofing@aol.com

Mart, Inc.

Address 1503 Perry St Participation Type: Active Supplier  
Irving, TX 75060

Classifications TAS,TPA,SBE (Primary)

Invitation Date 03/12/2021  
Invitation Type Automatic  
Invitation Email(s) tim@martgc.com projects@martgc.com

Martek Industries Inc

Address 600 Deer Rd Ste 8 Participation Type: Active Supplier  
Cherry Hill, NJ 08034

Invitation Date 03/12/2021  
Invitation Type Automatic  
Invitation Email(s) martekleds@gmail.com

Massachusetts

Address One Ashburton Place Participation Type: Active Supplier  
Boston, MA 02108

Invitation Date 03/12/2021  
Invitation Type Manual  
Invitation Email(s)

Mav-Con LLC

Address 8904 Rolling Hills Dr. Participation Type: Inactive Supplier  
Laredo, TX 78045

Invitation Date 03/12/2021  
Invitation Type Automatic  
Invitation Email(s) jperry@maverick-contractors.com

MCA Communications

Address 525 Northville Participation Type: Active Supplier  
Houston, TX 77037

Classifications MBE (Primary),DIR,HUB

Invitation Date 03/12/2021  
Invitation Type Automatic  
Invitation Email(s) tina.lang@mcacom.com

McCrary Engineering

Address 11381 Meadowglen Ln Participation Type: Active Supplier  
Houston, TX 77082

Classifications MBE (Primary),SBE,HUB

Invitation Date 03/12/2021  
Invitation Type Automatic  
Invitation Email(s) thomas@mccroryeng.com



McCune Electrical Service

Address 8312 W Little York Rd Participation Type: Active Supplier  
Hosuton, TX 77040

Invitation Date 03/12/2021  
Invitation Type Automatic  
Invitation Email(s) joe@mccuneelectric.com

Mcdaniel Builders Inc

Address 24705 Weeren rd Participation Type: Active Supplier  
Montgoery, TX 77313

Invitation Date 03/12/2021  
Invitation Type Automatic  
Invitation Email(s) dyson@mcdanielbuildersinc.net

McGee Electrical Services, Inc.

Address 310 N Rogers Rd Participation Type: Active Supplier  
Irving, TX 75061

Classifications SBE (Primary)

Invitation Date 03/12/2021  
Invitation Type Automatic  
Invitation Email(s) wmcgee@mesvc.com

McGraw-Hill Construction /Dodge Reports

Address 4300 Beltway Pl Ste 180 Participation Type: Active Supplier  
Arlington, TX 76018

Invitation Date 03/12/2021  
Invitation Type Automatic  
Invitation Email(s)

McGriff Seibels and williams

Address 818 Town and Country Blvd Participation Type: Active Supplier  
Houston, TX 77449

Invitation Date 03/12/2021  
Invitation Type Automatic  
Invitation Email(s) mjefferson@mcgriff.com

McKenna Contracting, Inc

Address 1936 Old Holzwarth RD Participation Type: Active Supplier  
Spring, TX 77388

Classifications TAS,TCP,TIP,SBE,WBE (Primary)

Invitation Date 03/12/2021  
Invitation Type Automatic  
Invitation Email(s) accounting@mckennacontracting.net betsy@mckennacontracting.net

McKinstry (McKinstry Essention, Inc.)

Address 4201 Spring Valley Rd. Participation Type: Active Supplier  
Dallas, TX 75244

Classifications TIP (Primary)

Invitation Date 03/12/2021  
Invitation Type Automatic  
Invitation Email(s) brookm@mckinstry.com

MCS Enterprises

Address 4112 Fannin  
Houston, TX 77004 Participation Type: Active Supplier

Classifications MBE,SBE (Primary)

Invitation Date 03/12/2021  
Invitation Type Automatic  
Invitation Email(s)

McVey Paint & Wallcovering, Inc.

Address 2322 Timberbranch Ct  
Magnolia, TX 77355 Participation Type: Active Supplier

Classifications SBE (Primary)

Invitation Date 03/12/2021  
Invitation Type Automatic  
Invitation Email(s) roxannemcvey@aol.com

METCO Engineering, Inc.

Address 3333 Lee PKWY  
Dallas, TX 75219 Participation Type: Active Supplier

Response Date 05/07/2021  
Response Status Submitted  
Status Date 05/07/2021

Mezquite Installation Inc

Address 2952 Ladybird Ln  
Dallas, TX 75220 Participation Type: Active Supplier

Invitation Date 03/12/2021  
Invitation Type Automatic  
Invitation Email(s) vmunoz@mezquiteinstallations.com

MGS Supply & Services

Address 20770 Westheimer Parkway Suite #501  
Katy, TX 77450 Participation Type: Active Supplier

Invitation Date 03/12/2021  
Invitation Type Automatic  
Invitation Email(s) allie@mgssupplyandservices.com

MHE Intermediate Holdings,LLC (Miner Houston, Ltd)

Address 8329 Kempwood  
Houston, TX 77055 Participation Type: Active Supplier

Invitation Date 03/12/2021  
Invitation Type Automatic  
Invitation Email(s) jbartels@minercorp.com

Michael S Homes Jr (Michael S. Homes Jr.)

Address 523 North Suire St  
Erath, LA 70533 Participation Type: Active Supplier

Classifications SBE (Primary)

Invitation Date 03/12/2021  
Invitation Type Automatic  
Invitation Email(s) manmcrawfishexpress@yahoo.com

Mid America Metals (Renaissance Metals, In.c)

Address 2400 Central Park NW Participation Type: Active Supplier  
Houston, TX 771092

Classifications SBE (Primary)

Invitation Date 03/12/2021  
Invitation Type Automatic  
Invitation Email(s) dea@midamericametals.com

Mid South Lubrication Systems (Mid South Engine and Machine)

Address 2201 East Hwy 80 Participation Type: Active Supplier  
White Oak, TX 75693

Invitation Date 03/12/2021  
Invitation Type Automatic  
Invitation Email(s) GHILL@MIDSOUTHLS.COM

Mid-America Contractors, LLC (Mid-America Metal Roofing & Siding Installed, LLC)

Address 101 Procter St. Participation Type: Active Supplier  
Port Arthur, TX 77640

Classifications SBE (Primary),HUB,WBE

Invitation Date 03/12/2021  
Invitation Type Automatic  
Invitation Email(s) elizabeth@m-ac.us

Mid-Continental Restoration Company, Inc.

Address 4101 Murray Ave. Participation Type: Active Supplier  
Fort Worth, TX 76117

Invitation Date 03/12/2021  
Invitation Type Automatic  
Invitation Email(s) dalynne\_fowler@midcontinental.com brad\_boyd@midcontinental.com  
Response Date 05/07/2021  
Response Status Submitted  
Status Date 05/07/2021

Midessa Electric LLC

Address PO Box 8471 Participation Type: Active Supplier  
Midland, TX 79708-8471

Invitation Date 03/12/2021  
Invitation Type Automatic  
Invitation Email(s) robert.martinez@midessa-electric.com

Mid-South Waterproofing Systems, Inc

Address 14904 Lillja Rd. Participation Type: Active Supplier  
Houston, TX 77060

Invitation Date 03/12/2021  
Invitation Type Automatic  
Invitation Email(s) midsouthwaterproofingsystems@yahoo.com

Midstate Energy, LLC, A Veregy Company

Address 23325 N 23rd Ave Participation Type: Active Supplier  
Phoenix, AZ 85027

Invitation Date 03/12/2021  
Invitation Type Automatic  
Invitation Email(s) vesparza@veregy.com

Midstream and Terminal Services

Address 9950 Westpark Dr., Houston, TX 77063 Participation Type: Active Supplier

Classifications MBE (Primary),SBE,HUB

Invitation Date 03/12/2021  
Invitation Type Automatic  
Invitation Email(s) gmostofa@midstream-terminal.com

Milam & Co. Painting, Inc.

Address 4550 Allen St Houston, TX 77007 Participation Type: Active Supplier

Classifications MBE (Primary),SBE,HUB

Invitation Date 03/12/2021  
Invitation Type Automatic  
Invitation Email(s) David3@milampainting.com amber@milampainting.com

Millennium Project Solutions, Inc.

Address 14026 FM 2100 Crosby, TX 77532 Participation Type: Active Supplier

Invitation Date 03/12/2021  
Invitation Type Automatic  
Invitation Email(s) estimating@mps-team.com

Minnesota

Address 75 Rev Dr. Martin Luther King Jr. Blvd. St. Paul, MN 55155 Participation Type: Active Supplier

Invitation Date 03/12/2021  
Invitation Type Manual  
Invitation Email(s)

Miracle Method of Austin (Nartor Associates Inc)

Address 8906 Wall St, Suite 501 Austin, TX 78754 Participation Type: Active Supplier

Invitation Date 03/12/2021  
Invitation Type Automatic  
Invitation Email(s) adominick@miraclemethod.com

Miracle Method Surface Refinishing

Address 4310 Arrowswest Dr Colorado Springs, CO 80907 Participation Type: Active Supplier

Invitation Date 03/12/2021  
Invitation Type Automatic  
Invitation Email(s) tmcpherson@miraclemethod.com

Mississippi

Address Post Office Box 849 Jackson, MS 39205 Participation Type: Active Supplier

Invitation Date 03/12/2021  
Invitation Type Manual  
Invitation Email(s)

Missouri

Address PO Box 809 Jefferson City, MO 65102 Participation Type: Active Supplier

Invitation Date 03/12/2021  
Invitation Type Manual  
Invitation Email(s)

Mitchell Contracting

Address 5401 Milwee  
Houston, TX 77092 Participation Type: Active Supplier

Classifications SBE (Primary)

Invitation Date 03/12/2021  
Invitation Type Automatic  
Invitation Email(s) mike@mitchellcontracting.com  
Response Date 05/07/2021  
Response Status Submitted  
Status Date 05/07/2021

MJ McMurrey Construction LLC

Address 1603 Walton Street  
Houston, TX 77009 Participation Type: Active Supplier

Invitation Date 03/12/2021  
Invitation Type Automatic  
Invitation Email(s) marshall@mjmcm.com

MJR EDUCATIONAL SUPPLIES

Address 14504 Briar Forest Drive Houston, TX  
77077 Participation Type: Active Supplier  
Houston, TX 77077

Invitation Date 03/12/2021  
Invitation Type Automatic  
Invitation Email(s)

ML Deer Construction

Address 7720 Westview Dr  
Houston, TX 77055 Participation Type: Active Supplier

Invitation Date 03/12/2021  
Invitation Type Automatic  
Invitation Email(s) RTrevino@MLDeer.com

MMS-TX GROUP, LLC

Address 22877 Delta DR  
PORTER, TX 77365 Participation Type: Active Supplier

Invitation Date 03/12/2021  
Invitation Type Automatic  
Invitation Email(s) mmartinez@mmstxgroup.com

Modernized Designs, LLC

Address 4725 Teal Bend Blvd #1784  
Fresno, TX 77545 Participation Type: Active Supplier

Classifications MBE (Primary),SBE

Invitation Date 03/12/2021  
Invitation Type Automatic  
Invitation Email(s) modernizeddesigns@yahoo.com

ModSpace (Modular Space Corporation)

Address 10604 1/2 Wallisville Road  
Houston, TX 77013 Participation Type: Active Supplier

Invitation Date 03/12/2021  
Invitation Type Automatic  
Invitation Email(s) denis.maxson@modspace.com

Modular Management Group, Inc.

Address 1615 Rogers Road  
Fort Worth, TX 76107 Participation Type: Active Supplier

Invitation Date 03/12/2021  
Invitation Type Automatic  
Invitation Email(s)

MODULAR SOLUTIONS, LTD

Address PO BOX 15507  
PHOENIX, AZ 85060 Participation Type: Active Supplier

Classifications MBE,SBE (Primary)

Invitation Date 03/12/2021  
Invitation Type Automatic  
Invitation Email(s) COMPANY@MODULARSOLUTIONSLTD.COM

Molitor Enterprises (Larry Molitor)

Address 122 FM 2550  
Huntsville, TX 77320 Participation Type: Active Supplier

Classifications SBE (Primary)

Invitation Date 03/12/2021  
Invitation Type Automatic  
Invitation Email(s)

Montgomery Building Services LLC

Address P O Box 187  
Montgomery, TX 77356 Participation Type: Active Supplier

Invitation Date 03/12/2021  
Invitation Type Automatic  
Invitation Email(s) Montgomerybuildingservices@msn.com

Moore Supply Company (Hajoca)

Address 15090 Sommermeyer, Suite 100  
Houston, TX 77041 Participation Type: Active Supplier

Invitation Date 03/12/2021  
Invitation Type Automatic  
Invitation Email(s) brian.bateman@mooresupply.com

Mooring Recovery Services

Address 2110 113th Street  
Grand Prairie, TX 75050 Participation Type: Active Supplier

Classifications TCP (Primary),TIP

Invitation Date 03/12/2021  
Invitation Type Automatic  
Invitation Email(s) kaaron@mooringusa.com  
Response Status Viewed  
Status Date 04/28/2021

Morales Construction Services, Inc.

Address P.O. Box 248  
Mansfield, TX 76063 Participation Type: Active Supplier

Invitation Date 03/12/2021  
Invitation Type Automatic  
Invitation Email(s) rey@morales-cs.com

MPACT STRATEGIC CONSULTING, LLC

Address 4615 SW Freeway  
Houston, TX 77027 Participation Type: Active Supplier

Invitation Date 03/12/2021  
Invitation Type Automatic  
Invitation Email(s) abartholomew@mpact-consulting.com

Mr Electric of NW Houston

Address 13325 VETERANS MEMORIAL  
HOUSTON, TX 77014 Participation Type: Active Supplier

Classifications MBE,SBE (Primary),HUB

Invitation Date 03/12/2021  
Invitation Type Automatic  
Invitation Email(s) rocky.burgess@mail.mrelectric.com

MTC Exterior Maintenance

Address 3818 Glenwood Drive  
Richmond, TX 77406 Participation Type: Active Supplier

Invitation Date 03/12/2021  
Invitation Type Automatic  
Invitation Email(s) wkizziah@comcast.net

MultiDrain Systems, Inc.

Address 1405 Industrial Drive  
Statesville, NC 28625 Participation Type: Active Supplier

Invitation Date 03/12/2021  
Invitation Type Automatic  
Invitation Email(s) Rosalyn.Thorneburg@MultiDrainSystems.com

Multivista (Multivista Systems, LLC)

Address 5345 Spring Valley Road  
Dallas, TX 75254 Participation Type: Active Supplier

Invitation Date 03/12/2021  
Invitation Type Automatic  
Invitation Email(s) d.greer@multivista.com m.fletcher@multivista.com j.morrison@multivista.com

MW Services Inc.

Address 301 W. Mission Ave  
Oceanside, CA 92054 Participation Type: Active Supplier

Classifications MBE,SBE (Primary),WBE

Invitation Date 03/12/2021  
Invitation Type Automatic  
Invitation Email(s)

MYCON GENERAL CONTRACTORS

Address 1702 Ponderosa Drive  
College Station, TX 77845 Participation Type: Active Supplier

Invitation Date 03/12/2021  
Invitation Type Automatic  
Invitation Email(s) dwalters@mycon.com

Myelyn Contractors

Address 2313 Ridgewood Drive  
Plano, TX 75074 Participation Type: Active Supplier

Invitation Date 03/12/2021  
Invitation Type Automatic  
Invitation Email(s) Myelyncontractors@gmail.com

Myron Mcdowell Construction

---

Address 306 N. Main, Suite F Participation Type: Active Supplier  
Dayton, TX 77535

Invitation Date 03/12/2021  
Invitation Type Automatic  
Invitation Email(s) myron@myronmcdowellconstruction.com

N&T Construction Co., Inc

---

Address 1376 Laurel Ave Participation Type: Active Supplier  
Beaumont, TX 77701

Classifications HUB (Primary),WBE

Invitation Date 03/12/2021  
Invitation Type Automatic  
Invitation Email(s) ejabbia@nandtconstruction.com

Nacogdoches Iron Works, Inc.

---

Address 4750 South US Hwy 59 Participation Type: Active Supplier  
Nacogdoches, TX 75964

Invitation Date 03/12/2021  
Invitation Type Automatic  
Invitation Email(s) adavis@nacionworks.com

NAH Sports Flooring, LLC

---

Address 3528 East T.C. Jester BLVD Participation Type: Active Supplier  
Houston, TX 77018

Invitation Date 03/12/2021  
Invitation Type Automatic  
Invitation Email(s) ahammer@covington.com

Namco Dallas (Namco Cleaning Solutions Inc)

---

Address 707 Robbie Dr Suite 100 Participation Type: Active Supplier  
Irving, TX 75061

Classifications MBE,SBE (Primary),HUB,WBE

Invitation Date 03/12/2021  
Invitation Type Automatic  
Invitation Email(s) jramirez040@yahoo.com

Nash Industries, Inc.

---

Address 6610 Supply Row Participation Type: Active Supplier  
Houston, TX 77011

Invitation Date 03/12/2021  
Invitation Type Automatic  
Invitation Email(s) cnash@nashindustriesinc.com

National Glazing Solutions, LLC

---

Address 981 Joseph E Lowery Blvd NW Suite 106 Participation Type: Active Supplier  
Atlanta, GA 30318

Invitation Date 03/12/2021  
Invitation Type Automatic  
Invitation Email(s) Donnie@filmsandgraphics.com



Native Construction (Native Consolidated Management LLC)

---

Address 150 Sabine ST #341 Participation Type: Active Supplier  
Houston, TX 77007

Classifications MBE (Primary),SBE,HUB

Invitation Date 03/12/2021  
Invitation Type Automatic  
Invitation Email(s) john.lee@native-construction.com  
Response Date 05/04/2021  
Response Status Submitted  
Status Date 05/04/2021

---

NCRI-National Catastrophe Restoration, Inc

Address 8447 E. 35th St. North Participation Type: Active Supplier  
Wichita, KS 67226

Classifications WBE (Primary)

Invitation Date 03/12/2021  
Invitation Type Automatic  
Invitation Email(s) r.kerbs@ncricat.com

---

Near Future LLC

Address 10833 Alder Circle Participation Type: Active Supplier  
Dallas, TX 75238

Classifications MBE,HUB (Primary)

Invitation Date 03/12/2021  
Invitation Type Automatic  
Invitation Email(s) estimator@nearfuture.biz

---

NEIL TECHNICAL SERVICES CORP

Address 11304 windfern rd Participation Type: Active Supplier  
houston, TX 77064

Classifications SBE (Primary)

Invitation Date 03/12/2021  
Invitation Type Automatic  
Invitation Email(s) bworthington@ntshouston.com

---

Nester Enterprises

Address 7326 Reindeer Trail Participation Type: Active Supplier  
San Antonio, TX 78238

Classifications MBE (Primary)

Invitation Date 03/12/2021  
Invitation Type Automatic  
Invitation Email(s) arnold@nesterenterprises.com

---

Network Cabling Services, Inc.

Address 12626 Fuqua Street Participation Type: Active Supplier  
Houston, TX 77034

Classifications DIR,TCP,WBE (Primary)

Invitation Date 03/12/2021  
Invitation Type Automatic  
Invitation Email(s) mteel@ncs-tx.com

Neutex Advanced Energy Group, Inc

Address 14340 Torrey Chase Blvd, Suite 250 Participation Type: Active Supplier  
Houston, TX 77014

Invitation Date 03/12/2021  
Invitation Type Automatic  
Invitation Email(s) msamjr@neutexworld.com

New World Contracting, LLC

Address 6575 W. Loop South, Suite 500 Participation Type: Active Supplier  
Bellaire, TX 77401

Classifications MBE (Primary),SBE,HUB,WBE

Invitation Date 03/12/2021  
Invitation Type Automatic  
Invitation Email(s) d.vanderberg@newworldgc.com

New York

Address 633 Third Avenue Participation Type: Active Supplier  
New York, NY 10017

Invitation Date 03/12/2021  
Invitation Type Manual  
Invitation Email(s)

NextGen Bin Cleaning

Address 7817 Meadow Grove Drive Participation Type: Active Supplier  
McKinney, TX 75071

Classifications MBE (Primary),SBE,HUB,WBE

Invitation Date 03/12/2021  
Invitation Type Automatic  
Invitation Email(s) patricia@nextgenbincleaning.com

NJAC Construction

Address PO BOX 703 Participation Type: Active Supplier  
Seabrook, TX 77586

Invitation Date 03/12/2021  
Invitation Type Automatic  
Invitation Email(s) bmodisette@njacco.com

No Fa

Address 3112 Valley Creek Drive Suite C Participation Type: Active Supplier  
Baton Rouge, LA 70809

Invitation Date 03/12/2021  
Invitation Type Automatic  
Invitation Email(s) beth@nofault.com

No Slip, Just Grip LLC

Address 458 ASHLAND DR Participation Type: Active Supplier  
CORPUS CHRISTI, TX 78412

Invitation Date 03/12/2021  
Invitation Type Automatic  
Invitation Email(s) kirby@noslipjustgrip.com

Nobe Nash, Inc

Address 727 N. Shepherd Dr  
Houston, TX 77007 Participation Type: Active Supplier

Classifications TIP (Primary)

Invitation Date 03/12/2021  
Invitation Type Automatic  
Invitation Email(s) luis.garcia@nobenash.com

North Carolina

Address 1301 Mail Service Center  
Raleigh, NC 27699 Participation Type: Active Supplier

Invitation Date 03/12/2021  
Invitation Type Manual  
Invitation Email(s)

North Texas Safe Sidewalks LLC

Address 185 Cortez Drive  
Nocona, TX 76255 Participation Type: Active Supplier

Classifications SBE (Primary)

Invitation Date 03/12/2021  
Invitation Type Automatic  
Invitation Email(s)

Nouveau Construction and Technology Services (Nouveau Technology Services, LP)

Address 2441 Lacy Lane  
Carrollton, TX 75006 Participation Type: Active Supplier

Classifications TCP,SBE (Primary),HUB,WBE

Invitation Date 03/12/2021  
Invitation Type Automatic  
Invitation Email(s)

NVS Corporate Services, Inc.

Address 1474 W. Price Road, Suite 7  
Brownsville, TX 78520 Participation Type: Active Supplier

Classifications MBE,SBE (Primary),HUB

Invitation Date 03/12/2021  
Invitation Type Automatic  
Invitation Email(s) nicksoto@nvscsi.com

OBELLO, INC

Address 12500 Merit Drive  
Dallas, TX 75251 Participation Type: Active Supplier

Classifications MBE (Primary),WBE

Invitation Date 03/12/2021  
Invitation Type Automatic  
Invitation Email(s) dobcalldemo@gmail.com

O'Donnell/Snider Construction

Address 1900 WEST LOOP S  
HOUSTON, TX 77027 Participation Type: Active Supplier

Response Status Viewed  
Status Date 04/28/2021

Office Shines (CallWorksMedia,LLC)

Address 13003 Southwest freeway  
Stafford, TX 77477 Participation Type: Active Supplier

Classifications MBE (Primary),SBE,HUB

Invitation Date 03/12/2021  
Invitation Type Automatic  
Invitation Email(s) anthony.r@officeshines.com

Ohio State

Address 4200 Surface Road  
Columbus, OH 43228 Participation Type: Active Supplier

Invitation Date 03/12/2021  
Invitation Type Manual  
Invitation Email(s)

OLVAZ Construction Inc.

Address 16835 Headwaters Forest Dr.  
Humble, TX 78346 Participation Type: Active Supplier

Invitation Date 03/12/2021  
Invitation Type Automatic  
Invitation Email(s) M.olmeda@olvazconstruction.com

Omega Builders Group, L.P.

Address 9517 Yupondale Dr  
Houston, TX 77095 Participation Type: Active Supplier

Invitation Date 03/12/2021  
Invitation Type Automatic  
Invitation Email(s) omegabuilders@sbcglobal.net

Omega Engineers, Inc.

Address 16360 Park Ten Place, Ste 325  
Houston, TX 77084 Participation Type: Active Supplier

Classifications MBE,DIR,HGA,USC,SBE (Primary),HUB

Invitation Date 03/12/2021  
Invitation Type Automatic  
Invitation Email(s) scastaneda@omegaengineers.com

Omega Roofing & Construction

Address 16215 Westheimer Rd  
Houston, TX 77082 Participation Type: Active Supplier

Classifications MBE (Primary),SBE,HUB

Invitation Date 03/12/2021  
Invitation Type Automatic  
Invitation Email(s) jessica@omegarc.com

On Time Solutions (Dura Pier - TX, Inc.)

Address PO Box 900  
Conroe, TX 77305 Participation Type: Active Supplier

Classifications SBE (Primary)

Invitation Date 03/12/2021  
Invitation Type Automatic  
Invitation Email(s) ccd755@gmail.com

One More Round Inc

Address 10702 Ballantine Street  
Houston, TX 77075 Participation Type: Active Supplier

Invitation Date 03/12/2021  
Invitation Type Automatic  
Invitation Email(s) 1moreroundinc@gmail.com  
Response Date 03/19/2021  
Response Status No Bid  
Status Date 03/17/2021

OnePoint, Inc.

Address 9000 SW Fwy. #330  
Houston, TX 77074 Participation Type: Active Supplier

Classifications  
MBE,DIR,HGA,TAS,TCP,TIP,TPA,TXM,SBE  
(Primary)

Invitation Date 03/12/2021  
Invitation Type Automatic  
Invitation Email(s) ajoseph@onepointinc.com

OneTeam

Address 616 Cumberland Ave  
Syracuse, NY 13210 Participation Type: Active Supplier

Classifications SBE (Primary)

Invitation Date 03/12/2021  
Invitation Type Automatic  
Invitation Email(s) mark.lamphear@oneteamcny.com

OpTerra Energy Services, Inc.

Address 15150 Preston Road, Suite 300  
Dallas, TX 75248 Participation Type: Active Supplier

Classifications TCP (Primary),TIP

Invitation Date 03/12/2021  
Invitation Type Automatic  
Invitation Email(s)

Oregon

Address 350 Winter St  
Salem, OR 97301 Participation Type: Active Supplier

Invitation Date 03/12/2021  
Invitation Type Manual  
Invitation Email(s)

Ortiz Construction Group LLC

Address 301 Teal Ln.  
Kyle, TX 78640 Participation Type: Active Supplier

Invitation Date 03/12/2021  
Invitation Type Automatic  
Invitation Email(s) javierortiz@ortizconstructiongroup.net

Palacios Marine & Industrial Coatings, Inc.

Address PO Box 875  
Palacios, TX 77465 Participation Type: Active Supplier

Invitation Date 03/12/2021  
Invitation Type Automatic  
Invitation Email(s) jaime@palaciosmarineindustrial.com

Palm Building Care (New Palm Services LLC)

Address 7801 N Lamar Blvd, Suite F9 Austin, TX 78752 Participation Type: Active Supplier

Classifications SBE (Primary)

Invitation Date 03/12/2021  
Invitation Type Automatic  
Invitation Email(s) arapil@palmbuilding.com  
Response Status Viewed  
Status Date 05/07/2021

Palomar Modular Buildings, LLC

Address P.O. Box 909 DeSoto, TX 75123 Participation Type: Active Supplier

Classifications TCP,TIP,SBE (Primary)

Invitation Date 03/12/2021  
Invitation Type Automatic  
Invitation Email(s) jmartin@palomarmodular.com jtavern@palomarmodular.com jpulfer@palomarmodular.com

Panhandle Steel Buildings, Inc

Address P.O. Box 1278 Amarillo, TX 79105 Participation Type: Active Supplier

Invitation Date 03/12/2021  
Invitation Type Automatic  
Invitation Email(s) kpowers@psb-inc.com

PARADISE AIR (Luck & Logic Inc.)

Address 351 Columbia Memorial Pkwy Kemah, TX 77565 Participation Type: Active Supplier

Classifications SBE (Primary),WBE

Invitation Date 03/12/2021  
Invitation Type Automatic  
Invitation Email(s) paradiseairkemah@gmail.com

Paramount Metal Systems, LLC

Address 500 Pleasant Valley Drive, Bldg. A Little Rock, AR 72227 Participation Type: Active Supplier

Invitation Date 03/12/2021  
Invitation Type Automatic  
Invitation Email(s) mnorman@paramountmetalsystems.com

Patriot Contracting LLC

Address 300 Shepherd Drive Houston, TX 77007 Participation Type: Active Supplier

Invitation Date 03/12/2021  
Invitation Type Automatic  
Invitation Email(s) jhj@patriotllc.us  
Response Status Viewed  
Status Date 04/27/2021

Patriot Fence Company (Aquarius Chemical)

Address 4808 S. County Road 1140 Midland, TX 79706 Participation Type: Active Supplier

Classifications SBE (Primary)

Invitation Date 03/12/2021  
Invitation Type Automatic  
Invitation Email(s) bdavis@patriot-fence.com

Patriot Medical Solutions, LLC

Address 4320 NW 112th Ave  
Coral Springs, FL 33065 Participation Type: Active Supplier

Classifications MBE (Primary),SBE

Invitation Date 03/12/2021  
Invitation Type Automatic  
Invitation Email(s) carce@patriotmedicalsolutions.com

PB&J Pavement Marking, Inc.

Address 14019 SW Freeway #301-302  
Sugar Land, TX 77478 Participation Type: Active Supplier

Invitation Date 03/12/2021  
Invitation Type Automatic  
Invitation Email(s) bengleman@hotmail.com

PCJ Consultants Inc.

Address 13110 Green Shores Lane  
Rosharon, TX 77583 Participation Type: Active Supplier

Invitation Date 03/12/2021  
Invitation Type Automatic  
Invitation Email(s) pcj@pcj-usa.com

PECOS FENCE, INC.

Address 5220 LEONHARDT RD.  
SAN ANTONIO, TX 78233 Participation Type: Active Supplier

Classifications SBE (Primary)

Invitation Date 03/12/2021  
Invitation Type Automatic  
Invitation Email(s)

Penhall Company

Address 6728 Theall Rd  
Houston, TX 77066 Participation Type: Active Supplier

Invitation Date 03/12/2021  
Invitation Type Automatic  
Invitation Email(s) cevans@penhall.com

Pennsylvania

Address 508 Main Capitol Building  
Harrisburg, PA 17120 Participation Type: Active Supplier

Invitation Date 03/12/2021  
Invitation Type Manual  
Invitation Email(s)

Peoples' Door & Glass

Address 6124 Highway 6 North, Suite #200  
Houston, TX 77084 Participation Type: Active Supplier

Classifications SBE (Primary)

Invitation Date 03/12/2021  
Invitation Type Automatic  
Invitation Email(s) Rpeoplesdoor.glass@gmail.com

Performance Services, Inc.

Address 3010 LBJ Freeway  
Dallas, TX 75234 Participation Type: Active Supplier

Invitation Date 03/12/2021  
Invitation Type Automatic  
Invitation Email(s) dkirkley@performanceservices.com

Petro Progressive Services

Address 8900 Research Park Dr., APT 813  
THE WOODLANDS, TX 77381 Participation Type: Active Supplier

Classifications SBE (Primary)

Invitation Date 03/12/2021  
Invitation Type Automatic  
Invitation Email(s)

Pfeiffer & Son, Ltd.

Address 116 N 16th Street  
La Porte, TX 77571 Participation Type: Active Supplier

Invitation Date 03/12/2021  
Invitation Type Automatic  
Invitation Email(s) eodonel@pfeifferandson.com gparra@pfeifferandson.com joseph@pfeifferandson.com  
Response Status Viewed  
Status Date 05/03/2021

PHD Resources & Taxes

Address 7324 Southwest Fwy  
Houston, TX 77074 Participation Type: Active Supplier

Invitation Date 03/12/2021  
Invitation Type Automatic  
Invitation Email(s) positivehelpdetermined@gmail.com

Phoenix Architectural Products, Inc.

Address 3075 Jonquil Drive  
Smyrna, GA 30080 Participation Type: Active Supplier

Invitation Date 03/12/2021  
Invitation Type Automatic  
Invitation Email(s) cbarber@phoenixwindows.com

PIATRA INC

Address 5102 Woodview Ave  
Austin, TX 78756 Participation Type: Active Supplier

Classifications SBE (Primary),HUB,WBE

Invitation Date 03/12/2021  
Invitation Type Automatic  
Invitation Email(s) info@piatrainc.com

PIC Printing

Address 4521 S. Hulen Street  
Fort Worth, TX 76109 Participation Type: Active Supplier

Invitation Date 03/12/2021  
Invitation Type Automatic  
Invitation Email(s) info@pic-printing.com



Pick Two Interprise,LLC

Address 2018 FM 1942 Road Crosby, TX 77532 Participation Type: Active Supplier

Classifications MBE (Primary),SBE

Invitation Date 03/12/2021  
Invitation Type Automatic  
Invitation Email(s) pickoldschool@aol.com

Piling Products

Address 945 Center Street Green Cove Springs,, FL 32043 Participation Type: Active Supplier

Invitation Date 03/12/2021  
Invitation Type Automatic  
Invitation Email(s) shoneyman@pilingproducts.com

PL2O Construction & Consultancy

Address 14015 Southwest Freeway Sugar Land, TX 77478 Participation Type: Active Supplier

Classifications MBE (Primary),SBE

Invitation Date 03/12/2021  
Invitation Type Automatic  
Invitation Email(s) atul@pl2o.com

Platinum Fire Protection LLC

Address PO Box 841514 Pearland, TX 77566 Participation Type: Active Supplier

Classifications SBE (Primary)

Invitation Date 03/12/2021  
Invitation Type Automatic  
Invitation Email(s) sharrison@platinumfire.us

PMG PROJECT MANAGEMENT GROUP, LLC

Address 2723 Houston Ave Houston, TX 77009 Participation Type: Active Supplier

Classifications MBE,SBE (Primary),HUB

Invitation Date 03/12/2021  
Invitation Type Automatic  
Invitation Email(s) vladimirnarajo@pmgunited.com

Point Alliance Solutions

Address 2500 Citywest Blvd. Houston, TX 77042 Participation Type: Active Supplier

Classifications MBE (Primary),SBE,HUB

Invitation Date 03/12/2021  
Invitation Type Automatic  
Invitation Email(s) emanafshar@gmail.com Luis@pas-texas.com mikeafshar52@gmail.com  
Response Date 05/07/2021  
Response Status Submitted  
Status Date 05/07/2021

Polygon US Corporation

---

Address 1465 E. Sam Houston Pkwy S., Suite 190  
Pasadena, TX 77503 Participation Type: Active Supplier

Classifications TXM (Primary)

Invitation Date 03/12/2021  
Invitation Type Automatic  
Invitation Email(s) summer.street@polygongroup.com

PopSmart Technologie, LLC (PopSmart Technologies,LLC)

---

Address 13988 Diplomat Dr. #160  
Farmers Branch, TX 75234-8802 Participation Type: Active Supplier

Classifications MBE,HUB

Response Date 03/31/2021  
Response Status No Bid  
Status Date 03/31/2021

Post L Group, LLC

---

Address 4615 North Freeway  
Houston, TX 77022 Participation Type: Active Supplier

Invitation Date 03/12/2021  
Invitation Type Automatic  
Invitation Email(s) bids@postlgroup.com  
Response Status Unsubmitted  
Status Date 04/15/2021

Post Oak Construction LLC

---

Address 6514 Winfree Dr.  
Houston, TX 77087 Participation Type: Active Supplier

Invitation Date 03/12/2021  
Invitation Type Automatic  
Invitation Email(s) cesparza.poc@gmail.com jdelacruz.poc@gmail.com

Power Field Services (Marine Connection Services, Inc.)

---

Address 1555 FM 517 Rd West  
Dickinson, TX 77539 Participation Type: Active Supplier

Invitation Date 03/12/2021  
Invitation Type Automatic  
Invitation Email(s) havis@powerfieldservices.com

Power of Choosing Inc.

---

Address 17338 Shadow Ledge Dr  
Texas, TX 77095 Participation Type: Active Supplier

Classifications MBE (Primary),WBE

Invitation Date 03/12/2021  
Invitation Type Automatic  
Invitation Email(s)

Power Pro-Tech Services

---

Address 377 Maitland Ave  
Altamonte Springs, FL 32701 Participation Type: Active Supplier

Invitation Date 03/12/2021  
Invitation Type Automatic  
Invitation Email(s)

Precision Management Solution Inc.

Address 4565 River RD  
Ellenwood, GA 30294 Participation Type: Active Supplier

Invitation Date 03/12/2021  
Invitation Type Automatic  
Invitation Email(s) amorgan@precisionmgmtsolution.com

Premier Metalwerks, LLC

Address 4108 GLENVIEW DR  
Haltom City, TX 76117 Participation Type: Active Supplier

Invitation Date 03/12/2021  
Invitation Type Automatic  
Invitation Email(s) accounting@pmetalwerks.com

Premier Shade Design, LLC (Muse)

Address 17211 Fawn Cloud Ln  
San Antonio, TX 78248 Participation Type: Active Supplier

Invitation Date 03/12/2021  
Invitation Type Automatic  
Invitation Email(s) jim@premiershadedesign.com

Presidential Staffing Solutions

Address 7202 Glen Ellen Bay  
San Antonio, TX 78244 Participation Type: Active Supplier

Invitation Date 03/12/2021  
Invitation Type Automatic  
Invitation Email(s) m.nicole@presidentialstaffing.com

Prestige Building Maintenance

Address PO BOX 940003  
Houston, TX 77094 Participation Type: Active Supplier

Invitation Date 03/12/2021  
Invitation Type Automatic  
Invitation Email(s) j.botto@prestigebms.com

Prestigious Sports Outfitters (Rogers)

Address 6308 Saint Michael Drive  
McKinney, TX 75072 Participation Type: Active Supplier

Invitation Date 03/12/2021  
Invitation Type Automatic  
Invitation Email(s) trogers@prestigioussportsoutfitters.com

Prime Facility Services Group, Inc.

Address 6420 Richmond Avenue, #260  
Houston, TX 77056 Participation Type: Active Supplier

Invitation Date 03/12/2021  
Invitation Type Automatic  
Invitation Email(s) rafaelp@primefacilityservicesgroup.com

Prime Maintenance & Construction

Address 103 Commerce Rd.  
Alice, TX 78332 Participation Type: Active Supplier

Classifications HUB (Primary)

Invitation Date 03/12/2021  
Invitation Type Automatic  
Invitation Email(s) ccruz@pmc303.com

Primero Industrial Services, LTD.

Address 5330 Ave N Participation Type: Active Supplier  
Santa fe, TX 77510

Invitation Date 03/12/2021  
Invitation Type Automatic  
Invitation Email(s) jnarvaez@primeroindustrialservices.com

Prism Electric

Address 2985 Market Street Participation Type: Active Supplier  
Garland, TX 75041

Invitation Date 03/12/2021  
Invitation Type Automatic  
Invitation Email(s) glumsden@prismelectric.com cskutch@prismelectric.com gburns@prismelectric.com

Prodigy Construction Management, LLC

Address 1335 E. Jasmine Ave. Participation Type: Active Supplier  
McAllen, TX 78501

Classifications MBE,SBE (Primary),HUB

Invitation Date 03/12/2021  
Invitation Type Automatic  
Invitation Email(s)

Project Management Consultant LLC

Address PO Box 622 Participation Type: Active Supplier  
Jackson, MS 39205

Classifications MBE,SBE (Primary)

Invitation Date 03/12/2021  
Invitation Type Automatic  
Invitation Email(s) walter@projectmanagementconsultantllc.com

Proposal Riordan

Address 10606 Oak Valley Court Participation Type: Active Supplier  
Austin, TX 78736

Classifications WBE (Primary)

Invitation Date 03/12/2021  
Invitation Type Automatic  
Invitation Email(s) proposalriordan@austin.rr.com

Pro-Tech Facility Restoration, LLC

Address 10703 Highland Woods Participation Type: Active Supplier  
Sugar Land, TX 77498

Invitation Date 03/12/2021  
Invitation Type Automatic  
Invitation Email(s) Victor.Shin@pt-Restoration.com

PROTECHT Management Group, LLC

Address 7600 Burnet Road Participation Type: Active Supplier  
Austin, TX 78757-1241

Classifications SBE (Primary),HUB,WBE

Invitation Date 03/12/2021  
Invitation Type Automatic  
Invitation Email(s) dmisko@protechtmgmt.com

PSA Constructors Inc.

Address 2730 N. Stemmons Frwy  
Dallas, TX 75207 Participation Type: Active Supplier

Classifications MBE,SBE (Primary),HUB

Invitation Date 03/12/2021  
Invitation Type Automatic  
Invitation Email(s) chassall@psaonline.com paliu@psaonline.com

PTY Contractors LLC

Address 219 North Newnan Street  
Jacksonville, FL 32202 Participation Type: Active Supplier

Classifications MBE (Primary),SBE,WBE

Invitation Date 03/12/2021  
Invitation Type Automatic  
Invitation Email(s) erica@ptycontractors.com

PTY Multiservices, LLC

Address 2261 Northpark Dr #255  
Kingwood, TX 77339 Participation Type: Active Supplier

Invitation Date 03/12/2021  
Invitation Type Automatic  
Invitation Email(s) info@ptymultiservices.com

Pumps of Houston, Inc.

Address 10239 Cossey Rd  
Houston, TX 77070 Participation Type: Active Supplier

Classifications SBE (Primary)

Invitation Date 03/12/2021  
Invitation Type Automatic  
Invitation Email(s) tcook@pumpsofhouston.com

Pure Clean Building Services

Address 1621 No.51st St.  
washington park, IL 62204 Participation Type: Active Supplier

Invitation Date 03/12/2021  
Invitation Type Automatic  
Invitation Email(s) everett@purecleanstl.com

Pure Speed Lightwave

Address 5959 Corporate Drive  
Houston, TX 77036 Participation Type: Active Supplier

Classifications HUB,WBE

Invitation Date 03/12/2021  
Invitation Type Automatic  
Invitation Email(s) rfp@pslightwave.com kcruz@pslightwave.com

Pyramid Imports Tile & Flooring, Inc.

Address 3501 N Main St  
Houston, TX 77009 Participation Type: Active Supplier

Classifications MBE (Primary)

Response Status Viewed  
Status Date 05/06/2021

Pyrotex Systems

Address PO Box 1639  
Alvin, TX 77512 Participation Type: Active Supplier

Invitation Date 03/12/2021  
Invitation Type Automatic  
Invitation Email(s) tony@pyrotex-systems.com

QC7 Development Services, Ltd.

Address 17404 Caddy Court  
Charlotte, NC 28278 Participation Type: Active Supplier

Invitation Date 03/12/2021  
Invitation Type Automatic  
Invitation Email(s) jbatsell@qc7services.com

Q-Star Technology

Address 2730 Monterey Street  
Torrance, CA 90503 Participation Type: Active Supplier

Classifications SBE (Primary)

Invitation Date 03/12/2021  
Invitation Type Automatic  
Invitation Email(s) khillsman@qstartech.com CMead@qstartech.com

Quadra Mind Enterprise, Inc.

Address 6302 Stonewood Pointe lane  
Houston, TX 77066 Participation Type: Active Supplier

Classifications MBE,SBE (Primary),HUB,WBE

Invitation Date 03/12/2021  
Invitation Type Automatic  
Invitation Email(s) sfrancis@quadramindent.com

Quad-Tex Construction, Inc

Address 3600 Park Meadow  
Bryan, TX 77802 Participation Type: Active Supplier

Classifications SBE (Primary),HUB,WBE

Invitation Date 03/12/2021  
Invitation Type Automatic  
Invitation Email(s) tracy@quadtex.net  
Response Date 05/06/2021  
Response Status Submitted  
Status Date 05/06/2021

Quality Renovations and Construction

Address 4220 Clay St.  
Houston, TX 77023 Participation Type: Active Supplier

Classifications MBE (Primary)

Invitation Date 03/12/2021  
Invitation Type Automatic  
Invitation Email(s) tgonzalez@qualityrc.net

Quasar Data Center

Address 1001 Texas Street, Suite 310  
Houston, TX 77002 Participation Type: Active Supplier

Classifications SBE,HUB,WBE

Response Date 05/06/2021  
Response Status Submitted  
Status Date 05/06/2021

R&L Building Group

---

Address 3527 Mansfield st Houston, TX 77091 Participation Type: Active Supplier

Classifications MBE,HUB,WBE (Primary)

Invitation Date 03/12/2021

Invitation Type Automatic

Invitation Email(s)

R&T Architects, Inc.

---

Address 3300 S. Gessner Road, Suite 119 Houston, TX 77063 Participation Type: Active Supplier

Classifications MBE (Primary),HUB

Invitation Date 03/12/2021

Invitation Type Automatic

Invitation Email(s) rtarch@swbell.net

R.L. ROHDE GENERAL CONTRACTING, INC.

---

Address 4180 STUART ROAD ADKINS, TX 78101 Participation Type: Active Supplier

Classifications SBE (Primary)

Invitation Date 03/12/2021

Invitation Type Automatic

Invitation Email(s) ESTIMATING@RLROHDE.COM

Rachel Bryant CO

---

Address PO Box 163 Austin, TX 78767 Participation Type: Active Supplier

Classifications SBE (Primary),WBE

Invitation Date 03/12/2021

Invitation Type Automatic

Invitation Email(s) rachelbryantco@gmail.com

Radius Design Works, LLC

---

Address P.O. Box 54481 Cincinnati, OH 45254 Participation Type: Active Supplier

Invitation Date 03/12/2021

Invitation Type Automatic

Invitation Email(s) c\_berry@radiusdesignworks.com

Response Date 05/07/2021

Response Status Submitted

Status Date 05/07/2021

Rainbow International of Nacogdoches (Henderbi LLC)

---

Address 2500 East Main St. Nacogdoches, TX 75961 Participation Type: Active Supplier

Classifications SBE (Primary),WBE

Invitation Date 03/12/2021

Invitation Type Automatic

Invitation Email(s) jennifer.clark@rainbownac.com

Rainbow International of Weatherford

Address 2595 Old Brock Road  
Weatherford, TX 76087 Participation Type: Active Supplier

Classifications WBE (Primary)

Invitation Date 03/12/2021  
Invitation Type Automatic  
Invitation Email(s) nora.cipriani@gmail.com

Rainbow International of Webster

Address 2225 Lakeway Drive  
Friendswood, TX 77546 Participation Type: Active Supplier

Classifications MBE (Primary)

Invitation Date 03/12/2021  
Invitation Type Automatic  
Invitation Email(s) lprzymus@rainbowwebster.com

Rainbow International Restoration of San Antonio (Restoration Ventures Inc)

Address 16015 University Oak  
San Antonio, TX 78249 Participation Type: Active Supplier

Invitation Date 03/12/2021  
Invitation Type Automatic  
Invitation Email(s)

RAM Roofing Services LLC

Address 2140 E Southlake Blvd  
Southlake, TX 76092 Participation Type: Active Supplier

Invitation Date 03/12/2021  
Invitation Type Automatic  
Invitation Email(s) ramroofingservices@gmail.com

Ramtech Building Systems (Ramtech Building Systems, Inc)

Address 1400 US Hwy 287 S  
Mansfield, TX 76063 Participation Type: Active Supplier

Classifications HGA, TAS, TIP (Primary), SBE

Invitation Date 03/12/2021  
Invitation Type Automatic  
Invitation Email(s) ppattengill@ramtechgroup.com Squeen@ramtechgroup.com

Raus Construction LTD.

Address 1181 Brittmoore Road  
Houston, TX 77043 Participation Type: Active Supplier

Classifications SBE (Primary)

Invitation Date 03/12/2021  
Invitation Type Automatic  
Invitation Email(s) gshoemake@rausconstruction.com

RBR Construction, Inc.

Address 1214 Mineral Wells Hwy.  
Weatherford, TX 76086 Participation Type: Active Supplier

Classifications SBE (Primary)

Invitation Date 03/12/2021  
Invitation Type Automatic  
Invitation Email(s) bringo@rbrconstruction.com



RCK Equipment Solutions (Curtis Collins and Katina Collins)

---

Address 6000 N Sam Houston Pkwy E #610 Participation Type: Active Supplier  
Humble, TX 77396

Invitation Date 03/12/2021  
Invitation Type Automatic  
Invitation Email(s) Katina@rckequip.com

RCS Roofing & Sheet Metal

---

Address 101 E. McKinney St. #2294 Participation Type: Active Supplier  
Denton, TX 76202

Classifications SBE (Primary)

Invitation Date 03/12/2021  
Invitation Type Automatic  
Invitation Email(s) info@rcsroofingandmetal.com

RDI Mechanical

---

Address 7150 Breen Dr. Participation Type: Active Supplier  
Houston, TX 77086

Invitation Date 03/12/2021  
Invitation Type Automatic  
Invitation Email(s) chris@rdimechanical.com  
Response Date 04/22/2021  
Response Status Submitted  
Status Date 04/22/2021

Ready Trans Limited Liability Company

---

Address 14560 Pensham Dr Participation Type: Active Supplier  
Frisco, TX 75035

Invitation Date 03/12/2021  
Invitation Type Automatic  
Invitation Email(s) udaymachchhar@gmail.com

Real Network Services, Inc. (Crosley)

---

Address 5529 Redfield St. Participation Type: Active Supplier  
Dallas, TX 75235

Classifications MBE (Primary),SBE,HUB

Invitation Date 03/12/2021  
Invitation Type Automatic  
Invitation Email(s) jreyes@aboutreal.com

Red Rocket Electric

---

Address 9110 Kirkmont Drive Participation Type: Active Supplier  
Houston, TX 77089

Invitation Date 03/12/2021  
Invitation Type Automatic  
Invitation Email(s) redrocketelectrical@gmail.com

Red Rocket Electric Llc

---

Address 7730 Arrowhead Lane Participation Type: Active Supplier  
Houston, TX 77075

Classifications MBE (Primary),SBE

Invitation Date 03/12/2021  
Invitation Type Automatic  
Invitation Email(s) redrocketinfo01@gmail.com

Redd Team by Sapa

Address 125 Superior Drive  
Delhi, LA 71232 Participation Type: Active Supplier

Invitation Date 03/12/2021  
Invitation Type Automatic  
Invitation Email(s) wilson.alvarez@sapagroup.com

Reed construction data

Address 30 technology parkway south  
Norcross, GA 30092 Participation Type: Active Supplier

Invitation Date 03/12/2021  
Invitation Type Automatic  
Invitation Email(s) tom.clarke@reedbusiness.com

Reeder Concrete, Inc.

Address 1930 Hinton Dr.  
Irving, TX 75061 Participation Type: Active Supplier

Classifications SBE (Primary)

Invitation Date 03/12/2021  
Invitation Type Automatic  
Invitation Email(s) mikereeder@verizon.net

Refrigeration Technologies, LLC

Address 1055 South Hanover St.  
Pottstown, PA 19465 Participation Type: Active Supplier

Classifications SBE (Primary)

Invitation Date 03/12/2021  
Invitation Type Automatic  
Invitation Email(s) sj.wezel@gmail.com marybeth@refrigerationtechnologiesllc.com  
Response Status Viewed  
Status Date 05/07/2021

RegeniSource (RegeniSource LLC)

Address 20770 Hwy 281N  
San Antonio, TX 78258 Participation Type: Active Supplier

Invitation Date 03/12/2021  
Invitation Type Automatic  
Invitation Email(s) rod@regenisource.com

Regiment Commercial Construction

Address 3257 Corrigan Ln.  
Round Rock, TX 78665 Participation Type: Active Supplier

Classifications MBE (Primary),SBE

Invitation Date 03/12/2021  
Invitation Type Automatic  
Invitation Email(s) john@regimentcommercial.com

Remedy Contractors

Address 21925 Franz Rd.  
Katy, TX 77449 Participation Type: Active Supplier

Classifications SBE (Primary)

Invitation Date 03/12/2021  
Invitation Type Automatic  
Invitation Email(s) jslivensky@remedyroofing.com otraylor@comcast.net

Remy Dillenseger

Address 7457 Rusk St  
Houston, TX 77011 Participation Type: Active Supplier

Classifications SBE (Primary)

Response Date 04/06/2021  
Response Status No Bid  
Status Date 04/06/2021

Renaissance Power Conservation

Address PO Box 11723  
Norfolk, VA 23517 Participation Type: Active Supplier

Classifications SBE (Primary)

Invitation Date 03/12/2021  
Invitation Type Automatic  
Invitation Email(s) info@whywastepower.com

Renegade Construction LLC

Address 2019 Sunset Court  
League City, TX 77573 Participation Type: Active Supplier

Invitation Date 03/12/2021  
Invitation Type Automatic  
Invitation Email(s) RFP@renegadeconstruction.org

Renovate Paint and Design (CLL Specialists, Corp.)

Address 3502 Salano  
San Antonio, TX 78259 Participation Type: Active Supplier

Invitation Date 03/12/2021  
Invitation Type Automatic  
Invitation Email(s) carol@renovatepaint.com

Restoration Services, Inc. (A & E Tech Reps)

Address P.O. Box 41069  
Houston, TX 77241-1069 Participation Type: Active Supplier

Invitation Date 03/12/2021  
Invitation Type Automatic  
Invitation Email(s) bryan@rsi-restorationservices.com  
Response Date 05/06/2021  
Response Status Submitted  
Status Date 05/06/2021

Restoration Specialists (Restoration Specialists, LLC)

Address 4501 Sunbelt Drive  
Addison, TX 75001 Participation Type: Active Supplier

Classifications TAS (Primary),TCP

Invitation Date 03/12/2021  
Invitation Type Automatic  
Invitation Email(s)

Revitalize Maintenance, LLC

Address P.O. Box 451467  
Houston, TX 77245 Participation Type: Active Supplier

Invitation Date 03/12/2021  
Invitation Type Automatic  
Invitation Email(s)

Rhode Island

---

Address 1 Capitol Hill  
Providence, RI 02908 Participation Type: Active Supplier

Invitation Date 03/12/2021  
Invitation Type Manual  
Invitation Email(s)

Right Choice cleaning & Restoration

---

Address 10119 Golden Meadow dr.  
Houston, TX 77064 Participation Type: Active Supplier

Invitation Date 03/12/2021  
Invitation Type Automatic  
Invitation Email(s)

Right Choice Materials Company

---

Address 16000 Barkers Point Lane  
Houston, TX 77079 Participation Type: Active Supplier

Classifications MBE (Primary),TAS,SBE,HUB

Invitation Date 03/12/2021  
Invitation Type Automatic  
Invitation Email(s) diana@rightchoicemc.com

Rio Roofing, Inc.

---

Address 310 Hanmore Industrial Pkwy  
Harlingen, TX 78550 Participation Type: Active Supplier

Invitation Date 03/12/2021  
Invitation Type Automatic  
Invitation Email(s) Rioroofervp@aol.com

Roadrunner Restoration (Progressive Fire & Flood, Inc)

---

Address 5117 Hiltonview  
HOUSTON, TX 77086 Participation Type: Active Supplier

Invitation Date 03/12/2021  
Invitation Type Automatic  
Invitation Email(s) talaniz@roadrunnerrestoration.com

Rob Pelletier Construction, Inc

---

Address 12402 Eastex Freeway  
Houston, TX 77039 Participation Type: Active Supplier

Classifications MBE (Primary),HUB,WBE

Invitation Date 03/12/2021  
Invitation Type Automatic  
Invitation Email(s) chuck@rpcinc.com sarah@rpcinc.com

Roberto Gamez (RP COS MANAGEMENT INC)

---

Address 20115 Salzburg Ln  
Humble, TX 77338 Participation Type: Active Supplier

Classifications MBE (Primary),SBE,HUB

Invitation Date 03/12/2021  
Invitation Type Automatic  
Invitation Email(s) r.gamez@rppcos.com

Rolland Safe and Lock Company

---

Address 3140 Towerwood Drive Participation Type: Active Supplier  
DALLAS, TX 75234

Invitation Date 03/12/2021  
Invitation Type Automatic  
Invitation Email(s) david@rslc.net

RoofCARE

---

Address 7117 Belgold street suite c Participation Type: Active Supplier  
Houston, TX 77066

Invitation Date 03/12/2021  
Invitation Type Automatic  
Invitation Email(s) jj@roofcare.us

RoofConnect Logistics, Inc

---

Address 44 Grant 65 Participation Type: Active Supplier  
Sheridan, AR 72150

Invitation Date 03/12/2021  
Invitation Type Automatic  
Invitation Email(s) jeremy.hill@roofconnect.com

Roofing Designs by JR LLC (OEG Construction and Services)

---

Address 5970 N Sam Houston Pkwy E Participation Type: Active Supplier  
HUMBLE, TX 77396

Classifications MBE (Primary),SBE,HUB,WBE

Invitation Date 03/12/2021  
Invitation Type Automatic  
Invitation Email(s) Chyna@roofingdesigns.com

Royal American Services, Inc.

---

Address 5909 West Loop South Participation Type: Active Supplier  
Bellaire, TX 77401

Classifications SBE (Primary)

Invitation Date 03/12/2021  
Invitation Type Automatic  
Invitation Email(s) sgoldman@ggras.net rgoldman@ggras.net

Royalty by Deziign LLC

---

Address 12302 W Dreyfus Dr Participation Type: Active Supplier  
EI Mirage, AZ 85335

Invitation Date 03/12/2021  
Invitation Type Automatic  
Invitation Email(s) tanaea.wright@royaltybydeziign.com

RR CONNECTION CONSULTING

---

Address 150 E. HWY 67 STE 218 Participation Type: Active Supplier  
Duncanville, TX 75137

Classifications MBE,SBE,WBE (Primary)

Invitation Date 03/12/2021  
Invitation Type Automatic  
Invitation Email(s) rgreer@rrcglc.com

RS3 Turf

---

Address 3400 east palm valley blvd  
round rock, TX 78665 Participation Type: Active Supplier

Invitation Date 03/12/2021  
Invitation Type Automatic  
Invitation Email(s)

Rubber Flooring Systems, Inc.

---

Address 375 Columbia Memorial Pkwy  
Kemah, TX 77565 Participation Type: Active Supplier

Invitation Date 03/12/2021  
Invitation Type Automatic  
Invitation Email(s) michelle@teamrfs.com

Rudd Plumbing Company (Rudd Contracting Co., Inc.)

---

Address 1502 East Erwin Street  
Tyler, TX 75702 Participation Type: Active Supplier

Invitation Date 03/12/2021  
Invitation Type Automatic  
Invitation Email(s) RodneyR@RuddContracting.com

S Corporation

---

Address 2037 Chestnut St Fl 1  
Phila, PA 19103 Participation Type: Active Supplier

Classifications MBE (Primary),SBE,WBE

Invitation Date 03/12/2021  
Invitation Type Automatic  
Invitation Email(s) d.banks@chazacinc.com

SAB Industries LLC

---

Address 2437 1/2 University Blvd  
Houston, TX 77005 Participation Type: Active Supplier

Invitation Date 03/12/2021  
Invitation Type Automatic  
Invitation Email(s) susan.bono@sabind.com  
Response Date 03/17/2021  
Response Status No Bid  
Status Date 03/17/2021

Sabre Commercial

---

Address 2001 Chicon St.  
Austin, TX 78722 Participation Type: Active Supplier

Invitation Date 03/12/2021  
Invitation Type Automatic  
Invitation Email(s) jbarton@sabrecommercial.com

SAK Construction, LLC

---

Address 864 Hoff Road  
O'Fallon, MO 63366 Participation Type: Active Supplier

Classifications TAS (Primary),TCP

Invitation Date 03/12/2021  
Invitation Type Automatic  
Invitation Email(s) bhirtz@sakon.com Charliek@sakon.com

Saldana Architects

Address 4040 Broadway St. Participation Type: Active Supplier  
San Antonio, TX 78209

Classifications MBE (Primary),SBE,HUB

Invitation Date 03/12/2021  
Invitation Type Automatic  
Invitation Email(s) isela@saldanaarchitects.com

Salone Capital LLC

Address 140 E. Lake Participation Type: Active Supplier  
Rockport, TX 78382

Classifications MBE,HUB (Primary)

Invitation Date 03/12/2021  
Invitation Type Automatic  
Invitation Email(s) Stephen@salonecapital.com

SAMES, INC.

Address 200 S. 10th Street, Suite 1500 Participation Type: Active Supplier  
McAllen, TX 78501

Invitation Date 03/12/2021  
Invitation Type Automatic  
Invitation Email(s) tirzah@samengineering-surveying.com

Sams Pack's five star ford

Address 2070 diplomat dr Participation Type: Active Supplier  
farmers branch, TX 75234

Invitation Date 03/12/2021  
Invitation Type Automatic  
Invitation Email(s) kevinhunter@spford.com

Saratoga Roofing & Construction (Mountain Top Enterprises, LLC)

Address 209 NW 132nd Street Participation Type: Active Supplier  
OKC, OK 73114

Classifications WBE (Primary)

Invitation Date 03/12/2021  
Invitation Type Automatic  
Invitation Email(s) s.franklin@saratogaroofing.com

Satellite Shelters, Inc.

Address 2530 Xenium Lane North Participation Type: Active Supplier  
Minneapolis, MN 55441

Classifications TAS (Primary)

Invitation Date 03/12/2021  
Invitation Type Automatic  
Invitation Email(s) lynnee@satelliteco.com

Sav-On Fence Inc.

Address 1803 Avondale haslet road Participation Type: Active Supplier  
Haslet, TX 76052

Invitation Date 03/12/2021  
Invitation Type Automatic  
Invitation Email(s)

Sawduzt Services, LLC.

---

Address 8218 Rushing Stream Ct. Participation Type: Active Supplier  
Tomball, TX 77375

Invitation Date 03/12/2021  
Invitation Type Automatic  
Invitation Email(s) damian@sawduztservices.com

SBA Houston (US Small Business Administration)

---

Address 8701 S. Gessner Drive, Suite 1200 Participation Type: Active Supplier  
Houston, TX 77074

Invitation Date 03/12/2021  
Invitation Type Automatic  
Invitation Email(s) Miguel.Ruiz@SBA.Gov

SBM General Contractor, LLC

---

Address 1413 CR 2744 Participation Type: Active Supplier  
Mico, TX 78056

Classifications SBE (Primary)

Invitation Date 03/12/2021  
Invitation Type Automatic  
Invitation Email(s) spmulvihill@aol.com

SCHRAMME CONSTRUCTION

---

Address 3611 RIVER FOREST DRIVE Participation Type: Active Supplier  
RICHMOND, TX 77406

Invitation Date 03/12/2021  
Invitation Type Automatic  
Invitation Email(s) lschramme@aol.com

Scogin Aire Mechanical (Scogin Aire Mechanical)

---

Address 3091 College Park Suite 240 #2 Participation Type: Active Supplier  
The Woodlands, TX 77384

Invitation Date 03/12/2021  
Invitation Type Automatic  
Invitation Email(s) Customerservice@scoginaire.com

Scope Builders LLC

---

Address 830 W. 22nd St. Participation Type: Active Supplier  
Houston, TX 77008

Classifications MBE,SBE (Primary)

Invitation Date 03/12/2021  
Invitation Type Automatic  
Invitation Email(s) raul@scope-builders.com hector@scope-builders.com

Scope28

---

Address 1529 Wirt Rd Participation Type: Inactive Supplier  
Houston, TX 77055

Invitation Date 03/12/2021  
Invitation Type Automatic  
Invitation Email(s) cflores@scope28.com



Scott Beck Construction.Inc

Address 4028 Rufe Snow Drive Participation Type: Active Supplier  
North Richland Hills, TX 76180

Classifications MBE,HUB,WBE (Primary)

Invitation Date 03/12/2021  
Invitation Type Automatic  
Invitation Email(s) mike@scottbeckconstruction.com

Scott Dennett Construction, LC

Address 2313 CULLEN ST Participation Type: Active Supplier  
FORT WORTH, TX 76107

Invitation Date 03/12/2021  
Invitation Type Automatic  
Invitation Email(s) janellem@dennettconstruction.com blakez@dennettconstruction.com

SDB Contracting Services (SDB, Inc)

Address 1001 S. Edward Drive Participation Type: Active Supplier  
Tempe, AZ 85281

Classifications TCP (Primary),TIP,TXM

Invitation Date 03/12/2021  
Invitation Type Automatic  
Invitation Email(s) sue.cardis@sdb.com leads.dallas@sdb.com keith.tomlinson@sdb.com christina.obrien@sdb.com  
casey.sundt@sdb.com  
Response Date 05/07/2021  
Response Status Submitted  
Status Date 05/07/2021

Seahurst Energy Services (Seahurst Electric)

Address PO Box 131974 Participation Type: Active Supplier  
The Woodlands, TX 77393

Classifications SBE (Primary)

Invitation Date 03/12/2021  
Invitation Type Automatic  
Invitation Email(s) ereeves@seahurst.com

SealWrap Installation, Inc

Address 1275 Glenlivet Dr Participation Type: Active Supplier  
Allentown, PA 18106

Invitation Date 03/12/2021  
Invitation Type Automatic  
Invitation Email(s)

SEMI USA CORPORATION

Address 6701 DEMOCRACY BOULEVARD Participation Type: Active Supplier  
BETHSEDA, MD 20817

Invitation Date 03/12/2021  
Invitation Type Automatic  
Invitation Email(s)

Seneca Mechanical LLC

Address PO Box 128 Participation Type: Active Supplier  
Nolanville, TX 76559

Invitation Date 03/12/2021  
Invitation Type Automatic  
Invitation Email(s) amyers@seneca-mechanical.com dturner@seneca-mechanical.com

Serenity Floor Care (Dirt Free Carpet & Tile Cleaning LLC)

Address 23826 Hopewell Dr Participation Type: Active Supplier  
Katy, TX 77493

Invitation Date 03/12/2021  
Invitation Type Automatic  
Invitation Email(s) joshua@serenityfloorcare.com

ServiceMaster by ABC Services (Phil Bryant)

Address 1106 Carby Rd. Participation Type: Active Supplier  
Houston, TX 77037

Classifications WBE (Primary)

Invitation Date 03/12/2021  
Invitation Type Automatic  
Invitation Email(s) phil.svm@comcast.net

ServiceMaster by Centex (CSTR Services LLC)

Address P.O. Box 1326 Participation Type: Active Supplier  
Waco, TX 76703

Invitation Date 03/12/2021  
Invitation Type Automatic  
Invitation Email(s) svmbcentex@sbcglobal.net

ServiceMaster Recovery Management (Service Environments of Texas, Inc.)

Address 801 Russell Palmer Road Participation Type: Active Supplier  
Kingwood, TX 77339

Invitation Date 03/12/2021  
Invitation Type Automatic  
Invitation Email(s) bhollibaugh@srmcat.com stan@smtrs.com

SERVPRO of Bear Creek (SPBC, LLC)

Address 1305 Upland Drive Participation Type: Active Supplier  
Houston, TX 77043

Classifications MBE,SBE (Primary),WBE

Invitation Date 03/12/2021  
Invitation Type Automatic  
Invitation Email(s)

Servpro of Beaumont (Triangle Restoration)

Address 2125 Stillwater Dr. #113 Participation Type: Active Supplier  
Beaumont, TX 77705

Invitation Date 03/12/2021  
Invitation Type Automatic  
Invitation Email(s) sales@servpro9927.com

SERVPRO of Friendswood/Pearland (ABM Restoration, LP)

Address 2537 Roy Rd. Participation Type: Active Supplier  
Pearland, TX 77588

Invitation Date 03/12/2021  
Invitation Type Automatic  
Invitation Email(s) spkimberly1@gmail.com

SERVPRO of Metro-Pittsburgh (MKS Services, Inc.)

Address 1951 Lincoln Highway Participation Type: Active Supplier  
North Versailles, PA 15137

Classifications SBE (Primary)

Invitation Date 03/12/2021  
Invitation Type Automatic  
Invitation Email(s)

SERVPRO of North Central Austin (Clean Slate Service, Inc.)

Address 13900 North Interstate 35 #J-1 Participation Type: Active Supplier  
Austin, TX 78728

Invitation Date 03/12/2021  
Invitation Type Automatic  
Invitation Email(s) owner@servpronorthcentrallaustin.com

Servpro of Pflugerville (Dimensions CLC, LLC)

Address 2215 Investment Dr Participation Type: Active Supplier  
Pflugerville, TX 78660

Invitation Date 03/12/2021  
Invitation Type Automatic  
Invitation Email(s)

SERVPRO of Spring/Tomball (AKS Holdings, Inc.)

Address P.O. Box 1366 Participation Type: Active Supplier  
Tomball, TX 77377

Invitation Date 03/12/2021  
Invitation Type Automatic  
Invitation Email(s) a\_scott@servprospringtomball.com

SERVPRO of Stafford/Missouri City (Hollen Enterprises Inc)

Address 1306 FM 1092 Participation Type: Active Supplier  
Missouri City, TX 77459

Classifications MBE,SBE (Primary),HUB,WBE

Invitation Date 03/12/2021  
Invitation Type Automatic  
Invitation Email(s) ccashiola@servpro10094.com

Servpro of the Woodlands/Conroe (S & R Operations, Inc.)

Address 2436 Peyton Road Participation Type: Active Supplier  
Houston, TX 77032

Classifications TCP,TIP,SBE,HUB (Primary),WBE

Invitation Date 03/12/2021  
Invitation Type Automatic  
Invitation Email(s) smeacham@servpro9734.com jmoore@servpro9734.com

Servpro of Town & Country, Servpro of Clear Lake (Jagwood, Inc.)

Address 10115 Papalote St, Ste. D Participation Type: Active Supplier  
Houston, TX 77041

Classifications SBE (Primary)

Invitation Date 03/12/2021  
Invitation Type Automatic  
Invitation Email(s) sp8868tc@sbcglobal.net

Servpro of Westfield (G&K Godwin Enterprises, Inc)

Address P.O. Box 73107 Participation Type: Active Supplier  
Houston, TX 77273

Classifications MBE,SBE (Primary)

Invitation Date 03/12/2021  
Invitation Type Automatic  
Invitation Email(s) ggodwin@servproofwestfield.com

Session Tax Consulting & Grant Writing (Session Tax Consulting and grant writing)

Address 10800 CLAY RD Participation Type: Active Supplier  
HOUSTON, TX 77041

Classifications MBE (Primary),SBE

Invitation Date 03/12/2021  
Invitation Type Automatic  
Invitation Email(s) edwina.session@hccs.edu

SETEX Facilities & Maintenance, LLC

Address PO Box 20678 Participation Type: Active Supplier  
Beaumont, TX 77720

Classifications SBE

Invitation Date 03/12/2021  
Invitation Type Automatic  
Invitation Email(s) Shannane@setexconstruction.com

Seyforth Services (Seyforth Services Inc)

Address 10520 Plano Rd. Suite 204 Participation Type: Active Supplier  
Dallas, TX 75238

Invitation Date 03/12/2021  
Invitation Type Automatic  
Invitation Email(s) dbhand07@att.net

Sharpline Coatings LLC

Address 23816 Bass Blvd Participation Type: Active Supplier  
Harlingen, TX 78552

Classifications MBE (Primary)

Invitation Date 03/12/2021  
Invitation Type Automatic  
Invitation Email(s) sharplinecoatings@gmail.com

Shaw Industries, Inc

Address 616 E. Walnut Ave Participation Type: Active Supplier  
Dalton, GA 30722

Invitation Date 03/12/2021  
Invitation Type Automatic  
Invitation Email(s)

Shepard Forest (4325 Costa Rica, LLC DBA Shepard Forest)

Address 2905 Washington Drive Participation Type: Active Supplier  
Houston, TX 77038

Classifications MBE (Primary)

Invitation Date 03/12/2021  
Invitation Type Automatic  
Invitation Email(s) shepardforest@aol.com

SI Restoration

Address 1121 Wilso Dr  
Baltimore, MD 21223 Participation Type: Active Supplier

Classifications DIR (Primary),TCP,TIP,USC

Invitation Date 03/12/2021  
Invitation Type Automatic  
Invitation Email(s) jeff.cohn@si-restoration.com

Siemens Industry, Inc

Address 8850 Fallbrook Rd  
Houston, TX 77063 Participation Type: Active Supplier

Classifications TXM (Primary)

Invitation Date 03/12/2021  
Invitation Type Automatic  
Invitation Email(s) keith.chase@seimens.com

Sigga Workforce Technologies

Address 13135 Dairy Ashford Rd  
Sugar Land, TX 77478 Participation Type: Active Supplier

Invitation Date 03/12/2021  
Invitation Type Automatic  
Invitation Email(s) mark.futrell@sigga.com

Sign Pro

Address 2112 E. William J. Bryan Pkwy  
Bryan, TX 77802 Participation Type: Active Supplier

Invitation Date 03/12/2021  
Invitation Type Automatic  
Invitation Email(s) tony.signpro@gmail.com

Signature Electric Services, LLC

Address 130 Lake Harbor Ln  
Huffman, TX 77336 Participation Type: Active Supplier

Invitation Date 03/12/2021  
Invitation Type Automatic  
Invitation Email(s) Signatureelectric@gmail.com

Signs of Success

Address 11301 Huffmeister  
Houston, TX 77065 Participation Type: Active Supplier

Invitation Date 03/12/2021  
Invitation Type Automatic  
Invitation Email(s) sales@signsuccess.com

Sitek Omni Services, LLC

Address 1017 1st Street East  
Humble, TX 77338 Participation Type: Active Supplier

Classifications SBE (Primary)

Invitation Date 03/12/2021  
Invitation Type Automatic  
Invitation Email(s) jwoodard@sitekomni.com

Sky Spotless Cleaners (ADAM NAMAL)

Address 6922 Silver Trace Ct Participation Type: Active Supplier  
Katy, TX 77449

Invitation Date 03/12/2021  
Invitation Type Automatic  
Invitation Email(s) cahidcakir@gmail.com

SLL Services, LLC

Address 39 Rambling Road Participation Type: Active Supplier  
Palestine, TX 75801

Classifications SBE (Primary)

Invitation Date 03/12/2021  
Invitation Type Automatic  
Invitation Email(s) llucas@sllservicesllc.com

Smart Pump Solutions, LLC.

Address 11603-A Brittmoores Park Dr. Participation Type: Active Supplier  
Houston, TX 77041

Classifications MBE, TCP, TIP, USC, SBE, HUB (Primary)

Invitation Date 03/12/2021  
Invitation Type Automatic  
Invitation Email(s) sergio@smartpumpsolutions.com

Smart Roofing Solutions

Address 7726 Drouet St Participation Type: Active Supplier  
Houston, TX 77061

Invitation Date 03/12/2021  
Invitation Type Automatic  
Invitation Email(s) lorena-smartroofingsolutions@outlook.com

Smart Scholars Foundation

Address 3615 Flannery Ridge Lane Participation Type: Active Supplier  
Houston, TX 77047

Classifications MBE (Primary), SBE, WBE

Invitation Date 03/12/2021  
Invitation Type Automatic  
Invitation Email(s) smart scholarsdirector@gmail.com

SMC Logistics

Address 13107 James Ln. Participation Type: Active Supplier  
Stafford, TX 77477

Classifications SBE (Primary)

Invitation Date 03/12/2021  
Invitation Type Automatic  
Invitation Email(s) smclogistics@yahoo.com

Sodexo Services of Texas Limited Partnership

Address 283 Cranes Roost Boulevard Participation Type: Active Supplier  
Altamonte Springs, FL 32701

Invitation Date 03/12/2021  
Invitation Type Automatic  
Invitation Email(s) educationales@sodexo.com

Solentrix, Inc.

Address 3422 Laura Koppe Road Participation Type: Active Supplier  
Houston, TX 77093

Classifications MBE,SBE (Primary),HUB,WBE

Invitation Date 03/12/2021  
Invitation Type Automatic  
Invitation Email(s) deyaburton@solentrixinc.com

Solidarity Contracting llc

Address 10100 w sam houston pkwy s #340 Participation Type: Active Supplier  
houston, TX 77099

Classifications SBE (Primary)

Invitation Date 03/12/2021  
Invitation Type Automatic  
Invitation Email(s) ulusal@solidaritycontracting.com

Solomie B LLC

Address 102 3rd street Participation Type: Active Supplier  
fountain inn, SC 29644

Classifications MBE (Primary)

Invitation Date 03/12/2021  
Invitation Type Automatic  
Invitation Email(s) ceo@solomieb.com

SOTERIA SAFETY SERVICES LLC

Address 4418 CR 138A Participation Type: Active Supplier  
ALVIN, TX 77511

Classifications SBE (Primary)

Invitation Date 03/12/2021  
Invitation Type Automatic  
Invitation Email(s)

South Carolina

Address Post Office Box 2825 Participation Type: Active Supplier  
Columbia, SC 29211

Invitation Date 03/12/2021  
Invitation Type Manual  
Invitation Email(s)

south texas boiler

Address 14715 east freeway Participation Type: Active Supplier  
houston, TX 77015

Classifications MBE (Primary),SBE,HUB

Invitation Date 03/12/2021  
Invitation Type Automatic  
Invitation Email(s) sylvia@stxboiler.com

SOUTH TEXAS PUMP INC

Address PO BOX 1852 Participation Type: Active Supplier  
WESLACO, TX 78599

Invitation Date 03/12/2021  
Invitation Type Automatic  
Invitation Email(s) stpump@gmail.com

South Texas Shop Services

Address 111 Tower Dr  
Friendswood, TX 77546 Participation Type: Active Supplier

Invitation Date 03/12/2021  
Invitation Type Automatic  
Invitation Email(s) Southtexasshopservices@gmail.com

Southeast Technical Solutions

Address P.O. Box 3145  
League City, TX 77573 Participation Type: Active Supplier

Classifications MBE,SBE (Primary),HUB

Invitation Date 03/12/2021  
Invitation Type Automatic  
Invitation Email(s) stsfn.com@gmail.com

Southeast Texas Drywall, LLC

Address 5520 Gorman Road  
Beaumont, TX 77705 Participation Type: Active Supplier

Classifications HUB (Primary)

Invitation Date 03/12/2021  
Invitation Type Automatic  
Invitation Email(s) breyes@setxdrywall.com

Southern Customs, Inc.

Address 9219 KATY FREEWAY, SUITE 130  
HOUSTON, TX 77024 Participation Type: Active Supplier

Classifications SBE (Primary)

Invitation Date 03/12/2021  
Invitation Type Automatic  
Invitation Email(s) soucou@swbell.net

Southern Prairie Mechanical LLC

Address 38 Wilson Rd  
Humble, TX 77338 Participation Type: Active Supplier

Invitation Date 03/12/2021  
Invitation Type Automatic  
Invitation Email(s) spmtacl@gmail.com

SOUTHWEST WHOLESALe LLC

Address 4241 PURDUE STREET  
HOUSTON, TX 77005 Participation Type: Active Supplier

Classifications MBE,HUB (Primary)

Invitation Date 03/12/2021  
Invitation Type Automatic  
Invitation Email(s) HUTCHISON@SWAT4241.COM

Sparkling Clear Industries

Address 422 WEST PLANTATION  
CLUTE, TX 77531 Participation Type: Active Supplier

Classifications SBE (Primary)

Invitation Date 03/12/2021  
Invitation Type Automatic  
Invitation Email(s) sjohnson@sparklingclear.com



Spartan National Construction Company

Address 5801 Blackmon Court  
Fort Worth, TX 76137 Participation Type: Active Supplier

Invitation Date 03/12/2021  
Invitation Type Automatic  
Invitation Email(s) Ashleigh@SpartanNationalConstruction.com

SpawGlass Construction Corp.

Address 350 Pine St. Suite 310  
Beaumont, TX 77701 Participation Type: Active Supplier

Invitation Date 03/12/2021  
Invitation Type Automatic  
Invitation Email(s) michael.green@spawglass.com

Specialty Commercial Contractors

Address 1600 N I-35E  
Carrollton, TX 75006 Participation Type: Active Supplier

Invitation Date 03/12/2021  
Invitation Type Automatic  
Invitation Email(s)

Specialty Painting & Wallcovering, Inc.

Address PO Box 1817  
Nederland, TX 77627 Participation Type: Active Supplier

Invitation Date 03/12/2021  
Invitation Type Automatic  
Invitation Email(s) mhall.specpaint@att.net

SpecPro, Inc.

Address 309 E 2nd St  
Papillion, NE 68046 Participation Type: Active Supplier

Classifications SBE (Primary),WBE

Invitation Date 03/12/2021  
Invitation Type Automatic  
Invitation Email(s) contracts@specproinc.com

Spigener Developement Inc.

Address 5314 Pine Ave  
Pasadena, TX 77503 Participation Type: Active Supplier

Classifications SBE (Primary)

Invitation Date 03/12/2021  
Invitation Type Automatic  
Invitation Email(s) jms@spigener.com

sport systems unlimited

Address 11319 Dellcrest Drive  
Huntsville, AL 35803 Participation Type: Active Supplier

Invitation Date 03/12/2021  
Invitation Type Automatic  
Invitation Email(s)

Spur Employment, Inc.

Address 3414 Governors Dr. SW #220  
HUNTSVILLE, AL 35805 Participation Type: Active Supplier

Invitation Date 03/12/2021  
Invitation Type Automatic  
Invitation Email(s) rfp@spurjobs.com

SRS Distribution Inc.

---

Address 5900 South Lake Forest Drive Participation Type: Active Supplier  
McKinney, TX 75070

Invitation Date 03/12/2021  
Invitation Type Automatic  
Invitation Email(s) ProjectBids@srsdistribution.com

SSCI Environmental (Separation Systems Consultants, Inc.)

---

Address 17041 El Camino Real Participation Type: Active Supplier  
Houston, TX 77058

Classifications MBE,SBE,HUB (Primary),WBE

Invitation Date 03/12/2021  
Invitation Type Automatic  
Invitation Email(s) ssci@sscienvironmental.com

Staff 4 Houston (TX Citywide Pro Services)

---

Address 10880 Westheimer Road Participation Type: Active Supplier  
Houston, TX 77042

Classifications MBE (Primary),SBE,HUB,WBE

Invitation Date 03/12/2021  
Invitation Type Automatic  
Invitation Email(s) adria@staff4houston.com

Standard Morgan Partners, LTD

---

Address 8500 Almeda-Genoa Rd. Participation Type: Active Supplier  
Houston, TX 77075

Invitation Date 03/12/2021  
Invitation Type Automatic  
Invitation Email(s) rfp@grgcommercial.com

Stanley Convergent Security

---

Address 6699 Portwest Drive, 100 Participation Type: Active Supplier  
Houston, TX 77024

Invitation Date 03/12/2021  
Invitation Type Automatic  
Invitation Email(s) christine.perry@sbdinc.com

Star Interior Resources (STARSD, Inc.)

---

Address 4615 Cole Ave. Participation Type: Active Supplier  
Dallas, TX 75205

Classifications SBE (Primary),WBE

Invitation Date 03/12/2021  
Invitation Type Automatic  
Invitation Email(s) christine.frankum@starfloors.com

STATE FEDERAL CONTRACTORS

---

Address PO BOX 202036 Participation Type: Active Supplier  
AUSTIN, TX 78720

Classifications TPA (Primary)

Invitation Date 03/12/2021  
Invitation Type Automatic  
Invitation Email(s) STATEFEDRL@AOL.COM

Stephens Fire Protection Group LLC

Address 409 North Cedar Ridge Circle Participation Type: Active Supplier  
Robinson, TX 76706

Classifications SBE,HUB (Primary),WBE

Invitation Date 03/12/2021  
Invitation Type Automatic  
Invitation Email(s) allison.stephens@stephensfpgroup.com

Sterling Structures, Inc.

Address 1425 Woodvine Participation Type: Active Supplier  
Houston, TX 77055

Classifications TCP (Primary)

Invitation Date 03/12/2021  
Invitation Type Automatic  
Invitation Email(s) pnunna@sterlingstructures.com  
Response Date 05/06/2021  
Response Status Submitted  
Status Date 05/06/2021

Stewart Builders, Inc.

Address 16575 Village Drive Participation Type: Active Supplier  
Houston, TX 77040

Invitation Date 03/12/2021  
Invitation Type Automatic  
Invitation Email(s) jeffc@stewartbuildersltd.com

Stiff LLC

Address 2401 S GESSNER RD Participation Type: Active Supplier  
HOUSTON, TX 77063

Classifications MBE (Primary),SBE,WBE

Invitation Date 03/12/2021  
Invitation Type Automatic  
Invitation Email(s) Niekell@stiffllc.com

STL Supply Company

Address 1210 Canterview Dr Participation Type: Active Supplier  
Houston, TX 77047

Classifications MBE,SBE (Primary),HUB,WBE

Invitation Date 03/12/2021  
Invitation Type Automatic  
Invitation Email(s) stlsupplycompany@gmail.com

STOA Architects

Address 6001 Savoy Drive Suite 100 Participation Type: Active Supplier  
Houston, TX 77036

Classifications MBE,SBE,HUB (Primary)

Invitation Date 03/12/2021  
Invitation Type Automatic  
Invitation Email(s) vlee@stoaintl.com

Stonhard Resinous Flooring (StonCor Group Inc)

---

Address 1000 East Park Avenue Participation Type: Active Supplier  
Maple Shade, NJ 08052

Invitation Date 03/12/2021  
Invitation Type Automatic  
Invitation Email(s) dspitz@stonhard.com

Straight Line Management (Straight Line Management LLC)

---

Address 734 N. New Braunfels, Suite 103 Participation Type: Active Supplier  
San Antonio, TX 78202

Invitation Date 03/12/2021  
Invitation Type Automatic  
Invitation Email(s)

Strategic Partnerships, Inc.

---

Address 901 S. Mopac Expy Participation Type: Active Supplier  
Austin, TX 78746

Classifications WBE (Primary)

Invitation Date 03/12/2021  
Invitation Type Automatic  
Invitation Email(s) kyoshida@spartnerships.com

STRAUS SYSTEMS INC

---

Address 7 STRAUS COURT Participation Type: Active Supplier  
STAFFORD, TX 77477

Invitation Date 03/12/2021  
Invitation Type Automatic  
Invitation Email(s)

StrongGlass Systems (MGT Films)

---

Address 260 Jamie Ln Participation Type: Active Supplier  
Wauconda, IL 60084

Invitation Date 03/12/2021  
Invitation Type Automatic  
Invitation Email(s) Dan@strongglassusa.com

Structura Design LLC

---

Address 1701 Commerce St. Ste 2B Participation Type: Active Supplier  
Houston, TX 77002

Classifications MBE,SBE (Primary)

Invitation Date 03/12/2021  
Invitation Type Automatic  
Invitation Email(s) mgarcia@structuradesign.com

Sublime HVAC Services

---

Address 324 e.main Participation Type: Active Supplier  
alice, TX 78332

Classifications MBE (Primary)

Invitation Date 03/12/2021  
Invitation Type Automatic  
Invitation Email(s) sublimehvac@yahoo.com

Sullivan Contracting Services (Pounds Group, LLC)

Address PO Box 2610 Participation Type: Active Supplier  
Seguin, TX 78156

Classifications HUB,WBE (Primary)

Invitation Date 03/12/2021  
Invitation Type Automatic  
Invitation Email(s) trey@scs-tx.com cody@scs-tx.com Morgan@scs-tx.com  
Response Date 05/06/2021  
Response Status Submitted  
Status Date 05/06/2021

Sunrise Construction (Santa Fe Sunrise Construction)

Address 395 cr.142 Participation Type: Active Supplier  
Alvin, TX 77511

Classifications SBE (Primary)

Invitation Date 03/12/2021  
Invitation Type Automatic  
Invitation Email(s) djolly\_sunriseconst@yahoo.com

Sunsational Solutions (Ten Twenty Four Industries, LLC)

Address 7801 N Lamar C63 Participation Type: Active Supplier  
Austin, TX 78752

Classifications TXM (Primary),HUB,WBE

Invitation Date 03/12/2021  
Invitation Type Automatic  
Invitation Email(s) lori@sunsationalsolutions.com

Supreme Crane and Rigging LLC

Address 24865 Wayne Rd Participation Type: Active Supplier  
Porter, TX 77365

Invitation Date 03/12/2021  
Invitation Type Automatic  
Invitation Email(s) Dan@SupremeCrane.com

Survive-a-Storm Shelters

Address 1206 Sunset Dr Participation Type: Active Supplier  
Thomasville, GA 31792

Classifications USC (Primary)

Invitation Date 03/12/2021  
Invitation Type Automatic  
Invitation Email(s) lucas.stewart@survive-a-storm.com

Swift Electric LLC

Address 328 N CIRCLE DR Participation Type: Active Supplier  
SEALY, TX 77474

Invitation Date 03/12/2021  
Invitation Type Automatic  
Invitation Email(s) travis@swiftellectrix.com

Swinerton

Address 5707 Southwest Parkway Participation Type: Active Supplier  
Austin, TX 78735

Invitation Date 03/12/2021  
Invitation Type Automatic  
Invitation Email(s) snamuth@swinerton.com

Symone Construction Services, LLC

Address 2414 Creekwood Drive Participation Type: Active Supplier  
Cedar Hill, TX 75104

Classifications MBE,SBE (Primary),HUB,WBE

Invitation Date 03/12/2021  
Invitation Type Automatic  
Invitation Email(s) lionspride\_4@sbcglobal.net

T & C Construction, LTD

Address 5411 Killough Participation Type: Active Supplier  
Houston, TX 77086

Invitation Date 03/12/2021  
Invitation Type Automatic  
Invitation Email(s) trumney@tc-con.com

T&G Constructors (T&G Corporation)

Address 8623 Commodity Cir. Participation Type: Active Supplier  
Orlando, FL 32819

Classifications MBE (Primary)

Invitation Date 03/12/2021  
Invitation Type Automatic  
Invitation Email(s) mknott@t-and-g.com

T.F. Harper & Associates, LP

Address 103 Red Bird Lane Participation Type: Active Supplier  
Austin, TX 78745

Classifications HGA (Primary),TAS,TCP

Invitation Date 03/12/2021  
Invitation Type Automatic  
Invitation Email(s) playground@tfharper.com

TAD 3 ENTERPRISES INC

Address 15006 Walters Road Participation Type: Active Supplier  
Houston, TX 77068

Classifications MBE,SBE (Primary),HUB

Invitation Date 03/12/2021  
Invitation Type Automatic  
Invitation Email(s) tad3enterprisesinc@gmail.com

Tailored Door & Glass Co., Inc

Address 2124 N. Sacramento Ave Participation Type: Active Supplier  
Pearland, TX 77581

Classifications SBE (Primary)

Invitation Date 03/12/2021  
Invitation Type Automatic  
Invitation Email(s) tdg2124@sbcglobal.net

Tandus Centiva US LLC

Address 311 Smith Industrial Blvd Participation Type: Active Supplier  
Dalton, GA 30722-1447

Invitation Date 03/12/2021  
Invitation Type Automatic  
Invitation Email(s) jeff.newman@tarkett.com Karen.Perucki@Tarkett.com courtney.keener@tarkett.com

Target Restoration Services (TRSI)

Address 5113 Steinbeck Bend Drive Participation Type: Active Supplier  
Waco, TX 76708

Invitation Date 03/12/2021  
Invitation Type Automatic  
Invitation Email(s)

Tates Contracting, LLC

Address 7521 Westview Participation Type: Active Supplier  
Houston, TX 77055

Classifications MBE,SBE (Primary),HUB

Invitation Date 03/12/2021  
Invitation Type Automatic  
Invitation Email(s)

Taylor Nicole

Address 1702 Teal Run Place Dr. Participation Type: Active Supplier  
Fresno, TX 77545

Classifications MBE,WBE (Primary)

Invitation Date 03/12/2021  
Invitation Type Automatic  
Invitation Email(s) bcokes57@aol.com  
Response Status Unsubmitted  
Status Date 05/07/2021

TCH (Alcott, Inc)

Address 4105 FM 2351 Participation Type: Active Supplier  
Friendswood, TX 77546

Classifications SBE (Primary),WBE

Invitation Date 03/12/2021  
Invitation Type Automatic  
Invitation Email(s) colbyellis@cablerunners.com

TDC Waterproofing & Restoration, LLC.

Address P.O. Box 41792 Participation Type: Active Supplier  
Houston, TX 77241

Classifications SBE (Primary)

Invitation Date 03/12/2021  
Invitation Type Automatic  
Invitation Email(s) sharie@tdcwaterproofing.com

TDG General Contractors

Address PO Box 675 Participation Type: Active Supplier  
Splendora, TX 77327

Invitation Date 03/12/2021  
Invitation Type Automatic  
Invitation Email(s)

TDT Plumbing (Texas Drain Technologies Inc)

Address 4918 Pinemont Drive, Suite A Participation Type: Active Supplier  
Houston, TX 77092

Classifications SBE (Primary)

Invitation Date 03/12/2021  
Invitation Type Automatic  
Invitation Email(s) eschwausch@tdtplumbing.com

Teal Construction Company

---

Address 1335 Brittmoores Road Participation Type: Active Supplier  
Houston, TX 77043

Invitation Date 03/12/2021  
Invitation Type Automatic  
Invitation Email(s) kourniesimpson@tealcon.com

Techland Houston (Bright Star Productions Inc.)

---

Address 2420 Center St. Participation Type: Active Supplier  
Houston, TX 77007

Classifications TXM (Primary)

Invitation Date 03/12/2021  
Invitation Type Automatic  
Invitation Email(s) sales@techlandhouston.com

Teinert Commercial Building Services (Allen Teinert Construction)

---

Address 4009 Clovis Road Participation Type: Active Supplier  
Lubbock, TX 79415

Invitation Date 03/12/2021  
Invitation Type Automatic  
Invitation Email(s) stacy@teinert.com

Tejas Electrical Services, Inc.

---

Address 23919 Lenze Road Participation Type: Active Supplier  
Spring, TX 77389

Classifications MBE,SBE (Primary),WBE

Invitation Date 03/12/2021  
Invitation Type Automatic  
Invitation Email(s) js1tejaselec@aol.com

Tellepsen Builders

---

Address 777 Benmar Dr Participation Type: Active Supplier  
Houston, TX 77060

Invitation Date 03/12/2021  
Invitation Type Automatic  
Invitation Email(s) scarney@tellepsen.com

Telomack Cabling Solutions (Telomack Inc)

---

Address 765 Sawdust Road Participation Type: Active Supplier  
The Woodlands, TX 77380

Invitation Date 03/12/2021  
Invitation Type Automatic  
Invitation Email(s) danwomack@telomack.com

Texas

---

Address 111 East 17th Street Participation Type: Active Supplier  
Austin, TX 78774

Invitation Date 03/12/2021  
Invitation Type Manual  
Invitation Email(s)



Texas Association of African American Chambers of Commerce (TAAACC)

Address 807 Brazos Street Participation Type: Active Supplier  
Austin, TX 78701

Classifications MBE,SBE (Primary),WBE

Invitation Date 03/12/2021  
Invitation Type Automatic  
Invitation Email(s) info@taaacc.org

Texas Best Window Cleaning (Leslie Martin)

Address 1508 Babbling Brook Dr Participation Type: Active Supplier  
Grand Prairie, TX 75050

Classifications MBE (Primary),SBE,HUB,WBE

Invitation Date 03/12/2021  
Invitation Type Automatic  
Invitation Email(s) frank@texasbestdfw.com

Texas Certified Roofing

Address 4740 Ingersoll Participation Type: Active Supplier  
Houston, TX 77027

Invitation Date 03/12/2021  
Invitation Type Automatic  
Invitation Email(s) yogi@texascertifiedroofing.com

Texas Chiller Systems

Address 1219 Safari Participation Type: Active Supplier  
San Antonio, TX 78216

Invitation Date 03/12/2021  
Invitation Type Automatic  
Invitation Email(s) mark.mcmurray@texaschillersystems.com

Texas Elite Electrical

Address 1707 Chrysler Street Participation Type: Active Supplier  
Liberty, TX 77575

Classifications SBE (Primary)

Invitation Date 03/12/2021  
Invitation Type Automatic  
Invitation Email(s) texaseliteelectrical@gmail.com

Texas General Contractors, Inc.

Address 4601 South Wayside Drive Participation Type: Active Supplier  
Houston, TX 77087

Invitation Date 03/12/2021  
Invitation Type Automatic  
Invitation Email(s) mgoodgame@texasgeneral.com aknoop@texasgeneral.com  
Response Date 05/04/2021  
Response Status Submitted  
Status Date 05/04/2021

Texas Groundworks Management, Inc.

Address P.O. Box 431713 Participation Type: Active Supplier  
Houston, TX 77243

Invitation Date 03/12/2021  
Invitation Type Automatic  
Invitation Email(s) mgr23@texasgroundworks.com

Texas Home and Projects LLC

Address 2685 N. Coria (rear) Participation Type: Active Supplier  
Brownsville, TX 78521

Classifications MBE (Primary)

Invitation Date 03/12/2021  
Invitation Type Automatic  
Invitation Email(s) jairojuarez@texashp.com

Texas Metal Roundup

Address 1040 County Road 368 Participation Type: Active Supplier  
Alvin, TX 77511

Invitation Date 03/12/2021  
Invitation Type Automatic  
Invitation Email(s) vikki@texasmetalroundup.com

Texas Precision Paving

Address P.O. BOX 841533 Participation Type: Active Supplier  
Houston, TX 77284

Classifications SBE (Primary)

Invitation Date 03/12/2021  
Invitation Type Automatic  
Invitation Email(s) robert@txprecisionpaving.com  
Response Status Viewed  
Status Date 05/04/2021

Texas Steam & Instrumentation (Texas Steam Equipment Company, Inc.)

Address 2302 S. BATTLEGROUND RD. Participation Type: Active Supplier  
LA PORTE, TX 77571

Invitation Date 03/12/2021  
Invitation Type Automatic  
Invitation Email(s) abiles@steamsolutions.com  
Response Status Viewed  
Status Date 04/27/2021

Texas Striping and Curb Appeal (Lamont Lagrone)

Address p.o.box 2182 Participation Type: Active Supplier  
Houston, TX 77004

Invitation Date 03/12/2021  
Invitation Type Automatic  
Invitation Email(s) Texasstripingandcurbappeal@gmail.com

Texas Tree Team (Intermodal Facility & Maintenance, Inc.)

Address 204 Schilling St. Participation Type: Active Supplier  
Baytown, TX 77520

Classifications SBE (Primary)

Invitation Date 03/12/2021  
Invitation Type Automatic  
Invitation Email(s) gginsel@houstonifm.com

TexLaCon Inc.

Address 10809 Millridge Pines Court Participation Type: Active Supplier  
Houston, TX 77070

Classifications MBE (Primary),SBE,WBE

Invitation Date 03/12/2021  
Invitation Type Automatic  
Invitation Email(s) tara.jones@texlacon.com

TFC Contracting Solutions

Address 703 Carrell Street  
Tomball, TX 77375 Participation Type: Active Supplier

Invitation Date 03/12/2021  
Invitation Type Automatic  
Invitation Email(s) rob@tfc-solutions.net

TFC MECHANICAL (TFC Mechanical LLC)

Address 1010 Squire  
Wylie, TX 75098 Participation Type: Active Supplier

Invitation Date 03/12/2021  
Invitation Type Automatic  
Invitation Email(s) jack@tfcmechanical.com

The Baptiste Group LLC

Address 945 Donegal Dr  
Locust Grove, GA 30248 Participation Type: Active Supplier

Invitation Date 03/12/2021  
Invitation Type Automatic  
Invitation Email(s) kevinb@thebaptistegroup.com

The Bid Calendar

Address 2903 Great Oaks Dr  
San Marcos, TX 78666 Participation Type: Active Supplier

Classifications SBE (Primary)

Invitation Date 03/12/2021  
Invitation Type Automatic  
Invitation Email(s) gjohnson@thebidcalendar.com

The Blue Book Network (Contractors Register)

Address 800 E. Main St.  
Jefferson Valley, NY 10535 Participation Type: Active Supplier

Invitation Date 03/12/2021  
Invitation Type Automatic  
Invitation Email(s) mlocascio@thebluebook.com dpeters@thebluebook.com

The Brandt Companies, LLC

Address 13810 Hollister Rd  
Houston, TX 77086 Participation Type: Active Supplier

Classifications TXM (Primary)

Invitation Date 03/12/2021  
Invitation Type Automatic  
Invitation Email(s) micah.hunter@brandt.us Toni.whitaker@brandt.us Trey.calvery@brandt.us Christopher.clegg@brandt.us  
Response Status Viewed  
Status Date 04/27/2021

The Comfort King (Gideon Lynn LLC)

Address 590 Brandon rd.  
Conroe, TX 78309 Participation Type: Active Supplier

Invitation Date 03/12/2021  
Invitation Type Automatic  
Invitation Email(s) Garrettcomfortking@gmail.com

The Deck & Canopy Company LLC

Address 13407 Oak Ledge Dr. Participation Type: Active Supplier  
Houston, TX 77065

Invitation Date 03/12/2021  
Invitation Type Automatic  
Invitation Email(s) josancerni@thedeckandcanopyco.com bsancerni@thedeckandcanopyco.com  
Response Status Viewed  
Status Date 05/07/2021

The Donatto Group

Address PO Box 321226 Participation Type: Active Supplier  
Houston, TX 77221

Classifications MBE (Primary),HUB  
Invitation Date 03/12/2021  
Invitation Type Automatic  
Invitation Email(s) james@thedonattogroup.com

THE E.T.H.E. GROUP

Address 11707 BERRY MEADOW DR Participation Type: Active Supplier  
HOUSTON, TX 77071

Classifications MBE (Primary),SBE  
Invitation Date 03/12/2021  
Invitation Type Automatic  
Invitation Email(s) orgorlink@aol.com

The Edu-Source Corporation

Address 6333 DeZavala Rd. Participation Type: Active Supplier  
San Antonio, TX 78249

Classifications MBE,TAS,SBE  
Invitation Date 03/12/2021  
Invitation Type Automatic  
Invitation Email(s) edusource@edusourcecorp.com mari@edusourcecorp.com  
Response Status Viewed  
Status Date 05/03/2021

THE FENCE LADY INC.

Address 104 KENDALL RIDGE Participation Type: Active Supplier  
BOERNE, TX 78015

Classifications HUB  
Invitation Date 03/12/2021  
Invitation Type Automatic  
Invitation Email(s) RDEAN1473@AOL.COM

The Filter Man LLC

Address 18924 E. Industrial Parkway Participation Type: Active Supplier  
New Caney, TX 77357

Invitation Date 03/12/2021  
Invitation Type Automatic  
Invitation Email(s) cathy@filtermanltd.com

The Gaia Group Inc.

Address 315 W. Alabama Suite 104 Participation Type: Active Supplier  
Houston, TX 77006

Classifications MBE,SBE (Primary),HUB

Invitation Date 03/12/2021  
Invitation Type Automatic  
Invitation Email(s) Kdale@thegaigroupinc.com

The Gonzalez Group, LP

Address 1245 Anderson Street Participation Type: Active Supplier  
Houston, TX 77081

Invitation Date 03/12/2021  
Invitation Type Automatic  
Invitation Email(s) tony@the-gonzalezgroup.com

The Kovacs Group

Address 540 Diamond Oak Participation Type: Active Supplier  
New Braunfels, TX 78132

Invitation Date 03/12/2021  
Invitation Type Automatic  
Invitation Email(s) jasond@kovacsgroup.net

The MarketinGroup, LLC

Address 2261 North Park Dr. Participation Type: Active Supplier  
Kingwood, TX 77339

Invitation Date 03/12/2021  
Invitation Type Automatic  
Invitation Email(s) tmg@themarketinggroup.us

The Mohawk Group

Address 1975 West Oak Circle Participation Type: Active Supplier  
Marietta, GA 30062

Invitation Date 03/12/2021  
Invitation Type Automatic  
Invitation Email(s)

The Phoenix Group (Phoenix Contracting Group)

Address 4702 Meadows Edge Lane Participation Type: Active Supplier  
Houston, TX 77084

Classifications SBE,WBE (Primary)

Invitation Date 03/12/2021  
Invitation Type Automatic  
Invitation Email(s) mac@phnxcg.com

The Ratliff Group, LLC

Address P.O. Box 949 Participation Type: Active Supplier  
COPPELL, TX 75019

Invitation Date 03/12/2021  
Invitation Type Automatic  
Invitation Email(s) bennett@ratliffgroup.com

The Remi Group

---

Address 11325 North Community House Rd., Participation Type: Active Supplier  
Suite 300  
Charlotte, NC 28277

Invitation Date 03/12/2021  
Invitation Type Automatic  
Invitation Email(s) marketingrpf@theremigroup.com

The Reynolds Company

---

Address 10502 Greens Crossing Blvd. Participation Type: Active Supplier  
Houston, TX 77038

Classifications TAS (Primary)

Invitation Date 03/12/2021  
Invitation Type Automatic  
Invitation Email(s) wlglas@reynco.com

The Safeguard System Inc. (Safeguard System Inc.)

---

Address 4401 Kostoryz Participation Type: Active Supplier  
Corpus Christi, TX 78415

Invitation Date 03/12/2021  
Invitation Type Automatic  
Invitation Email(s) rose@safeguardsysteminc.com  
Response Date 05/05/2021  
Response Status No Bid  
Status Date 05/05/2021

The Trevino Group, Inc.

---

Address 11410 Brittmoore Park Drive Participation Type: Active Supplier  
Houston, TX 77041

Classifications MBE,TAS,HUB (Primary)

Invitation Date 03/12/2021  
Invitation Type Automatic  
Invitation Email(s) etrevino@trevinogroup.com jryall@trevinogroup.com  
Response Date 05/07/2021  
Response Status Submitted  
Status Date 05/07/2021

The United Construction co

---

Address 10641 harwin Participation Type: Active Supplier  
Houston, TX 77036

Classifications MBE (Primary),HUB

Invitation Date 03/12/2021  
Invitation Type Automatic  
Invitation Email(s) clv150sab@gmail.com

the woodlands paints

---

Address 33418 egypt In. Participation Type: Active Supplier  
magnolia, TX 77354

Classifications MBE,SBE (Primary),HUB,WBE

Invitation Date 03/12/2021  
Invitation Type Automatic  
Invitation Email(s) victor@woodlandspaints.com

Thermal-Chem Corporation (Armitages Industries, Inc.)

Address 2550 Edgington St. Participation Type: Active Supplier  
Franklin Park, IL 60131

Invitation Date 03/12/2021  
Invitation Type Automatic  
Invitation Email(s)

Third Coast Insulation Systems, LLC

Address 4582 Kingwood Dr. Participation Type: Active Supplier  
Kingwood, TX 77345

Invitation Date 03/12/2021  
Invitation Type Automatic  
Invitation Email(s) steveb@thirdcoastinsulation.com

Thomas Printworks (Thomas Reprographics, Inc)

Address 4235 Richmond Ave Participation Type: Active Supplier  
Houston, TX 77027

Invitation Date 03/12/2021  
Invitation Type Automatic  
Invitation Email(s) trevor.hansen@thomasprintworks.com rock.gremillion@thomasprintworks.com  
tara.fisher@thomasprintworks.com joe.christ@thomasprintworks.com

Tico Telehealth Inc.

Address 10712 Culberson Participation Type: Active Supplier  
Austin, TX 78748

Classifications SBE (Primary),WBE

Invitation Date 03/12/2021  
Invitation Type Automatic  
Invitation Email(s) l.bibby@ticotelehealth.com

TiCon Texas Construction Services

Address 2335 Wirtcrest Lane Participation Type: Active Supplier  
Houston, TX 77055

Invitation Date 03/12/2021  
Invitation Type Automatic  
Invitation Email(s) tmurphy@ticontexas.com

TIGER RESTORATION AND REMODELING LLC

Address 9870 SAGEASPEN LN Participation Type: Active Supplier  
HOUSTON, TX 77089

Classifications MBE (Primary)

Invitation Date 03/12/2021  
Invitation Type Automatic  
Invitation Email(s) TIGERCONTRACTOR@GMAIL.COM

Timberline Homes Inc.

Address 2900 1st Ave S. Participation Type: Active Supplier  
Birmingham, AL 35233

Classifications SBE (Primary)

Invitation Date 03/12/2021  
Invitation Type Automatic  
Invitation Email(s) dburnham@timberlinecg.com

TinMan Enterprises (TX TinMan Enterprises, LLC)

Address 6731 Bridge St Ste 64 Participation Type: Active Supplier  
Fort Worth, TX 76112-0817

Classifications MBE (Primary),SBE,HUB,WBE

Invitation Date 03/12/2021  
Invitation Type Automatic  
Invitation Email(s) estimator@tin-man.net

Tippet Construction, LLC

Address 6027 Plantation Drive Participation Type: Active Supplier  
Baytown, TX 77523

Invitation Date 03/12/2021  
Invitation Type Automatic  
Invitation Email(s) tippetclay@gmail.com

TLC Engineering, Inc.

Address 8204 Westglen Drive Participation Type: Active Supplier  
Houston, TX 77063

Classifications MBE (Primary),SBE,HUB

Invitation Date 03/12/2021  
Invitation Type Automatic  
Invitation Email(s) tonycouncil@tlceng.com

TMB Screen Printing & Embroidery Spring

Address 21602 Tatton Crest Ct Participation Type: Active Supplier  
Spring, TX 77388

Invitation Date 03/12/2021  
Invitation Type Automatic  
Invitation Email(s) anita@tmbspring.com

TMI Solutions, LLC

Address 531 Pasiano Dr Participation Type: Active Supplier  
George West, TX 78022

Classifications SBE (Primary)

Invitation Date 03/12/2021  
Invitation Type Automatic  
Invitation Email(s)

Tommy Klein Construction, Inc.

Address 7312 Upland Avenue Participation Type: Active Supplier  
Lubbock, TX 79424

Classifications WBE (Primary)

Invitation Date 03/12/2021  
Invitation Type Automatic  
Invitation Email(s) jklein@tkleinconst.com kklein@tkleinconst.com

Top Invest

Address 4618 Merchant springs Ln Participation Type: Active Supplier  
Houston, TX 77084

Classifications SBE (Primary)

Invitation Date 03/12/2021  
Invitation Type Automatic  
Invitation Email(s) hidajet@sbcglobal.net  
Response Status Viewed  
Status Date 04/30/2021



Topwater Construction Services LLC

Address 1005 Airline Dr. Ste. A Participation Type: Active Supplier  
Katy, TX 77493

Classifications TIP,WBE (Primary)

Invitation Date 03/12/2021  
Invitation Type Automatic  
Invitation Email(s) simmie@topwatercsllc.com

Total Boiler & Mechanical, LLC

Address 8525 Hwy 35 S Participation Type: Active Supplier  
Liverpool, TX 77577

Invitation Date 03/12/2021  
Invitation Type Automatic  
Invitation Email(s) john.derrick@totalboiler.com

Total Lender Services LLC

Address 17711 E Strack Drive Participation Type: Active Supplier  
Spring, TX 77379

Classifications HUB,WBE (Primary)

Invitation Date 03/12/2021  
Invitation Type Automatic  
Invitation Email(s) john@resvcs.com

Total Team Companies, LLC

Address 3407 Lang Road Suite A Participation Type: Active Supplier  
Houston, TX 77092

Classifications MBE (Primary),HUB

Invitation Date 03/12/2021  
Invitation Type Automatic  
Invitation Email(s) invoicing@totalteamcons.com

Total Team Construction

Address 3407 Lang Road Participation Type: Active Supplier  
HOUSTON, TX 77092

Classifications MBE,SBE,HUB (Primary)

Invitation Date 03/12/2021  
Invitation Type Automatic  
Invitation Email(s) gyanez@totalteamcompanies.com

TouchView Inc

Address 830 W Chestnut St Participation Type: Active Supplier  
Brockton, MA 02301

Invitation Date 03/12/2021  
Invitation Type Automatic  
Invitation Email(s) frederick.bridges@icloud.com

TP&R CONSTRUCTION, L.L.C.

Address PO BOX 1761 Participation Type: Active Supplier  
DESOTO, TX 75123

Invitation Date 03/12/2021  
Invitation Type Automatic  
Invitation Email(s) FELICIA@TEXASRPREMODEL.COM

Transcare llc

---

Address 9203 hwy 6 S Participation Type: Active Supplier  
Houston, TX 77083

Invitation Date 03/12/2021  
Invitation Type Automatic  
Invitation Email(s) transcarehou@gmail.com

Travis Cox Plumbing Company, LLC

---

Address 8600 FM 150 W Participation Type: Active Supplier  
Kyle, TX 78640

Classifications WBE (Primary)

Invitation Date 03/12/2021  
Invitation Type Automatic  
Invitation Email(s) Vcox@traviscoxplumbing.com

Treco Services, Inc.

---

Address 904 N Zarzamora Participation Type: Active Supplier  
San Antonio, TX 78207

Classifications MBE (Primary),SBE,HUB,WBE

Invitation Date 03/12/2021  
Invitation Type Automatic  
Invitation Email(s) Debbiet@trecoervices.com

Triad Commercial Real Estate Services (Triad Commercial services, Ltd.)

---

Address 8600 Coppertowne Ln. #1502 Participation Type: Active Supplier  
Dallas, TX 75243

Classifications MBE,SBE (Primary),HUB

Invitation Date 03/12/2021  
Invitation Type Automatic  
Invitation Email(s) drettig@triadproperties.com

Trinity Roofing & Restoration (MCD Growth Services LLC)

---

Address 417 W. Hillary Circle Participation Type: Active Supplier  
SUGAR LAND, TX 77498

Classifications WBE (Primary)

Invitation Date 03/12/2021  
Invitation Type Automatic  
Invitation Email(s)

Triple B Cleaning, Inc.

---

Address 10720 Miller Road Participation Type: Active Supplier  
Dallas, TX 75238

Classifications WBE (Primary)

Invitation Date 03/12/2021  
Invitation Type Automatic  
Invitation Email(s)

Triple D Enterprises

---

Address 17722 Stamford Oaks Dr Participation Type: Active Supplier  
Tomball, TX 77377

Classifications SBE (Primary)

Invitation Date 03/12/2021  
Invitation Type Automatic  
Invitation Email(s) justin@tripleenterprises.net

Tri-Star Glass, Inc

Address 3110 Hwy 12 Participation Type: Active Supplier  
Vidor, TX 77662

Classifications SBE (Primary)

Invitation Date 03/12/2021  
Invitation Type Automatic  
Invitation Email(s) tristar409@yahoo.com

TRW MODERNFOLD CO., INC.

Address 6754 BOURGEOIS RD Participation Type: Active Supplier  
HOUSTON, TX 77066

Invitation Date 03/12/2021  
Invitation Type Automatic  
Invitation Email(s) spencerw@trwfamily.com

TSG Industries (The Sithe Group, LLC.)

Address 2626 South Loop West Participation Type: Active Supplier  
Houston, TX 77054

Classifications MBE (Primary),TAS,SBE,HUB

Invitation Date 03/12/2021  
Invitation Type Automatic  
Invitation Email(s) bmenefee@tsg-industries.com tsims@tsg-industries.com

Tucker Construction (Jon Tucker Construction, LTD)

Address 7425 Mize Rd. Participation Type: Active Supplier  
Bryan, TX 77808

Classifications HUB (Primary),WBE

Invitation Date 03/12/2021  
Invitation Type Automatic  
Invitation Email(s) phillip@jontuckerconstruction.com

Tucker Roofing Systems, LLC.

Address 5425 Lakeview Pkwy Participation Type: Active Supplier  
Rowlett, TX 75088

Invitation Date 03/12/2021  
Invitation Type Automatic  
Invitation Email(s) tucker@tuckerroofingsystems.com

Tulip Building

Address 914 pelicans way Participation Type: Active Supplier  
San Antonio, TX 78245

Invitation Date 03/12/2021  
Invitation Type Automatic  
Invitation Email(s) tulipconstruction@gmail.com

Turner Power and Construction, LLC (Turner Power Systems and Contractors, LLC)

Address 12707 Haynes Rd Participation Type: Active Supplier  
Houston, TX 77066

Invitation Date 03/12/2021  
Invitation Type Automatic  
Invitation Email(s) ron@turnerpower.com kimberly@turnerpower.com

TX Cleaning & Integral Solutions

Address 330 Trees Dr. Participation Type: Active Supplier  
Cedar Hill, TX 75104

Classifications MBE (Primary),SBE,HUB,WBE

Invitation Date 03/12/2021  
Invitation Type Automatic  
Invitation Email(s) o.cornieill@tx-cleaning.com

U. S. WHOLESALE PRODUCTS

Address PO BOX 34483 Participation Type: Active Supplier  
SAN ANTONIO, TX 78265

Classifications SBE (Primary)

Invitation Date 03/12/2021  
Invitation Type Automatic  
Invitation Email(s) uswpsanantonio@gmail.com

U.S Electronics recycling Center Inc (Isaac F Sunday)

Address 6210 S Dairly Ashford Suite A4 Participation Type: Active Supplier  
Houston, TX 77072

Classifications MBE (Primary),SBE

Invitation Date 03/12/2021  
Invitation Type Automatic  
Invitation Email(s) sunif1985@yahoo.com

Ultimate Plumbing

Address 1404 E Lons St Participation Type: Active Supplier  
Brownfield, TX 79316

Invitation Date 03/12/2021  
Invitation Type Automatic  
Invitation Email(s) ultimateplumbing@windstream.net

Unify Energy Solutions

Address 770 Bradfield, Suite 585 Participation Type: Active Supplier  
Houston, TX 77060

Classifications TIP (Primary)

Invitation Date 03/12/2021  
Invitation Type Automatic  
Invitation Email(s) donnym@unifytexas.com jeffn@unifyes.com todods@unifytexas.com

United CSH Services (United CSH Corporation)

Address PO BOX 31069 Participation Type: Active Supplier  
HOUSTON, TX 77231

Invitation Date 03/12/2021  
Invitation Type Automatic  
Invitation Email(s) dawn@unitedservices-tx.com

United Restoration & Preservation, Inc

Address 5575 Oakdale Rd. SE Participation Type: Active Supplier  
Mabelton, GA 30126

Invitation Date 03/12/2021  
Invitation Type Automatic  
Invitation Email(s) MattL@urpinc.com

UPKEEP PRESERVATION SERVICES LLC (MARIN)

Address 6302 GULF FREEWAY  
HOUSTON, TX 77023 Participation Type: Active Supplier

Classifications MBE (Primary),HUB

Invitation Date 03/12/2021  
Invitation Type Automatic  
Invitation Email(s) amupkeep@gmail.com

URETEK ICR Gulf Coast (Urelift Gulf Coast, LP)

Address 11603 Windfern Rd  
Houston, TX 77064 Participation Type: Active Supplier

Invitation Date 03/12/2021  
Invitation Type Automatic  
Invitation Email(s) mollyg@uretek-gulfcoast.com

Ursin's Energy Efficient Lighting,LLC.

Address 505 N. Sam Houston pkwy east ste#304  
Houston, TX 77060 Participation Type: Active Supplier

Classifications MBE,TPA,TXM,SBE (Primary),HUB

Invitation Date 03/12/2021  
Invitation Type Automatic  
Invitation Email(s) edursin@ursinsighting.net

US Executive LLC

Address 401 E. Jackson St Ste 2340D  
Tampa, FL 33602 Participation Type: Active Supplier

Classifications SBE (Primary)

Invitation Date 03/12/2021  
Invitation Type Automatic  
Invitation Email(s) ronnie.dempsey@us-executive.com  
Response Status Viewed  
Status Date 05/07/2021

Utility Services Associates, LLC

Address 919 SW 150th St  
Burien, WA 98166 Participation Type: Active Supplier

Classifications SBE (Primary)

Invitation Date 03/12/2021  
Invitation Type Automatic  
Invitation Email(s) bruce.rubin@usaleakslc.com

V V Construction, LLC.

Address 1313 Thistle Ln.  
Mansfield, TX 76063 Participation Type: Active Supplier

Invitation Date 03/12/2021  
Invitation Type Automatic  
Invitation Email(s) vq.vvcgroup@gmail.com

Vallelunga Enterprises LLC dba The Router Room,

Address 1211 Majesty  
Dallas, TX 75247 Participation Type: Active Supplier

Invitation Date 03/12/2021  
Invitation Type Automatic  
Invitation Email(s)

Varsity Facility Services (Varsity Contractors)

Address 3707 Constitution Drive  
Grand Prairie, TX 75052 Participation Type: Active Supplier

Invitation Date 03/12/2021  
Invitation Type Automatic  
Invitation Email(s) dheeth@kbs-services.com

Vaughn Construction (J.T. Vaughn Construction, LLC)

Address 10355 Westpark Drive  
Houston, TX 77042 Participation Type: Active Supplier

Invitation Date 03/12/2021  
Invitation Type Automatic  
Invitation Email(s) jjwasham@vaughnconstruction.com rmoore@vaughnconstruction.com sstcyr@vaughnconstruction.com  
ggreytok@vaughnconstruction.com mmitchell@vaughnconstruction.com

Venice Flooring and Remodeling

Address 7070 west 43rd st  
Houston, TX 77092 Participation Type: Active Supplier

Invitation Date 03/12/2021  
Invitation Type Automatic  
Invitation Email(s) marketing.vfr@gmail.com

Ventura Construction Inc.

Address 1350 E. Arapaho Rd. Suite 122  
Richardson, TX 75081 Participation Type: Active Supplier

Classifications HUB (Primary)

Invitation Date 03/12/2021  
Invitation Type Automatic  
Invitation Email(s) memo@venturainc.net

Verdant Web Technologies Inc.

Address 390 NE Emerson Ave STE 102  
Bend, OR 97701 Participation Type: Active Supplier

Invitation Date 03/12/2021  
Invitation Type Automatic  
Invitation Email(s) paul.stenbak@verdantwebtech.com

Vertex Roofing, LLC

Address 711 N. Carancahua St. # 1150  
Corpus Christi, TX 78401 Participation Type: Active Supplier

Classifications SBE (Primary)

Invitation Date 03/12/2021  
Invitation Type Automatic  
Invitation Email(s) sales@thevertexroof.com

Video Industrial Services, Inc.

Address 7721 2nd Ave N  
Birmingham, AL 35206 Participation Type: Active Supplier

Invitation Date 03/12/2021  
Invitation Type Automatic  
Invitation Email(s)

Virginia			
Address	101 N 14th St Richmond, VA 23219	Participation Type:	Active Supplier
Invitation Date	03/12/2021		
Invitation Type	Manual		
Invitation Email(s)			
Virtual Builders Exchange			
Address	4047 Naco Perrin San Antonio, TX 78217	Participation Type:	Active Supplier
Classifications	SBE (Primary)		
Invitation Date	03/12/2021		
Invitation Type	Automatic		
Invitation Email(s)	jeannette@virtualbx.com		
Response Status	Viewed		
Status Date	04/27/2021		
Virtus Group LLC			
Address	8765 Stockard Dr #202 Frisco, TX 75034	Participation Type:	Active Supplier
Invitation Date	03/12/2021		
Invitation Type	Automatic		
Invitation Email(s)			
Vistex Graphics, LLC			
Address	13014 Brittmoore Park Dr Houston, TX 77041	Participation Type:	Active Supplier
Invitation Date	03/12/2021		
Invitation Type	Automatic		
Invitation Email(s)	dstone@vistexgraphics.com		
Voceon Digital Radio Communications			
Address	1219 Price Plaza Houston, TX 77449	Participation Type:	Active Supplier
Invitation Date	03/12/2021		
Invitation Type	Automatic		
Invitation Email(s)	rrsmith@voceon.com		
Vortex Colorado			
Address	20 Odyssey Irvine, CA 92618	Participation Type:	Active Supplier
Classifications	DIR (Primary)		
Invitation Date	03/12/2021		
Invitation Type	Automatic		
Invitation Email(s)	staceym@vortexdoors.com		
vscoatings llc			
Address	1920 treble rd suite c3 Humble, TX 77338	Participation Type:	Active Supplier
Classifications	WBE (Primary)		
Invitation Date	03/12/2021		
Invitation Type	Automatic		
Invitation Email(s)	vscoatings@centurylink.net		

W. A. Robbins Construction Co., Inc.

Address 4622 Dagg Road  
Houston, TX 77048 Participation Type: Active Supplier

Classifications MBE,SBE (Primary),HUB

Invitation Date 03/12/2021  
Invitation Type Automatic  
Invitation Email(s) wendell3@warobbinsconstruction.com  
Response Status Viewed  
Status Date 05/07/2021

W. B. Construction and Son's Inc.

Address 7055 Fannett  
Beaumont, TX 77705 Participation Type: Active Supplier

Classifications MBE (Primary),HUB

Invitation Date 03/12/2021  
Invitation Type Automatic  
Invitation Email(s) info@wbconstructioninc.com

W.M. Jones Construction, Inc.

Address 400 Hobbs Rd Ste. 107  
League City, TX 77573 Participation Type: Active Supplier

Classifications WBE (Primary)

Invitation Date 03/12/2021  
Invitation Type Automatic  
Invitation Email(s) bill@wmjonesinc.com

wagner interiors

Address 10615 Sentinel St  
San Antonio, TX 78217-3811 Participation Type: Active Supplier

Invitation Date 03/12/2021  
Invitation Type Automatic  
Invitation Email(s) amy@allegiancefloors.com

Washington

Address P.O. Box 41160  
Olympia, WA 98504 Participation Type: Active Supplier

Invitation Date 03/12/2021  
Invitation Type Manual  
Invitation Email(s)

Waterman Construction

Address 4204 Gardendale Street  
San Antonio, TX 78229 Participation Type: Active Supplier

Classifications SBE (Primary)

Response Status Unsubmitted  
Status Date 05/06/2021

Watkins & Associates Consulting Services LLC.

Address 5330 Griggs Rd. Suite C #104  
Houston, TX 77021 Participation Type: Active Supplier

Invitation Date 03/12/2021  
Invitation Type Automatic  
Invitation Email(s) terriwatkins@sbcglobal.net mcwacsgroup@yahoo.com



Weatherproofing Services (Weatherproofing Service LLC)

Address 2336 Oak Grove Lane Participation Type: Active Supplier  
Cross Roads, TX 76227

Classifications WBE (Primary)

Response Date 05/07/2021  
Response Status Submitted  
Status Date 05/07/2021

WeatherTech Roofing, LLC

Address PO Box 171292 Participation Type: Active Supplier  
San Antonio, TX 78217

Classifications MBE (Primary),HUB

Invitation Date 03/12/2021  
Invitation Type Automatic  
Invitation Email(s) weathertechroofingllc@gmail.com

Webber Commercial Construction, LLC

Address 1725 Hughes Landing Blvd. Participation Type: Active Supplier  
The Woodlands, TX 77380

Invitation Date 03/12/2021  
Invitation Type Automatic  
Invitation Email(s)

West Virginia

Address 1900 Kanawha Blvd Participation Type: Active Supplier  
Charleston, WV 25305

Invitation Date 03/12/2021  
Invitation Type Manual  
Invitation Email(s)

Westco Ventures LLC

Address 4400 South Wayside Participation Type: Active Supplier  
Houston, TX 77087

Classifications MBE,SBE,HUB,WBE

Invitation Date 03/12/2021  
Invitation Type Automatic  
Invitation Email(s) awest@westcoventures.com nicole@westcoventures.com

Western Specialty Contractors (Western Waterproofing Company of America dba/ Western Specialty Contractors of America)

Address 10516 Manchaca Rd Participation Type: Active Supplier  
Austin, TX 78748

Invitation Date 03/12/2021  
Invitation Type Automatic  
Invitation Email(s) edc@westerngroup.com

Westwood Restoration, LLC

Address 9595 Six Pines Dr., Ste 6320 Participation Type: Active Supplier  
The Woodlands, TX 77380

Invitation Date 03/12/2021  
Invitation Type Automatic  
Invitation Email(s) britthaney@westwoodrestoration.com dwilliams@westwoodrestoration.com

White Star Services, LLC

Address P.O. Box 10323 Participation Type: Active Supplier  
Corpus Christi, TX 78460

Invitation Date 03/12/2021  
Invitation Type Automatic  
Invitation Email(s) whitestarservices@yahoo.com  
Response Status Viewed  
Status Date 04/29/2021

Wild Magnolia Landscaping LLC

Address PO BOX 2346 Participation Type: Active Supplier  
Crosby, TX 77532

Invitation Date 03/12/2021  
Invitation Type Automatic  
Invitation Email(s) wildmagnolialandscaping@gmail.com

Williamson Restoration Inc (Williamson Services Inc)

Address 5074 White Pine Dr Participation Type: Active Supplier  
Royse City, TX 75189

Classifications SBE (Primary)

Invitation Date 03/12/2021  
Invitation Type Automatic  
Invitation Email(s) brandy@williamsonrestoration.com tim@williamsonrestoration.com

Williamsville Resources Inc (Williamsville Resources II Inc)

Address 17711 E Strack Dr. Participation Type: Active Supplier  
Spring, TX 77379

Classifications HUB (Primary),WBE

Invitation Date 03/12/2021  
Invitation Type Automatic  
Invitation Email(s) sales@resvcs.com

Window Systems of Texas Inc.

Address 1620 FM 1960 Road East Participation Type: Active Supplier  
Houston, TX 77073

Classifications SBE (Primary),HUB

Invitation Date 03/12/2021  
Invitation Type Automatic  
Invitation Email(s) dmallette@windowssystemsoftexas.com

Wisconsin

Address P.O. Box 7864 Participation Type: Active Supplier  
Madison, WI 53707

Invitation Date 03/12/2021  
Invitation Type Manual  
Invitation Email(s)

Worldwide Power Products

Address 5711 Brittmoore Road Participation Type: Active Supplier  
Houston, TX 77041

Invitation Date 03/12/2021  
Invitation Type Automatic  
Invitation Email(s) sspidle@wpowerproducts.com

Wrench, Inc.

Address 1929 3rd Ave  
Seattle, WA 98101 Participation Type: Active Supplier

Classifications SBE (Primary)

Invitation Date 03/12/2021  
Invitation Type Automatic  
Invitation Email(s) klawrence@wrench.com

Wylie Construction Services

Address 4830 Wilson Rd  
Humble, TX 77396 Participation Type: Active Supplier

Invitation Date 03/12/2021  
Invitation Type Automatic  
Invitation Email(s) Travis@wylieconstructionllc.com travis@wylieconstructionllc.com mike@wylieconstructionllc.com  
Kerrick@wylieconstructionllc.com  
Response Date 05/07/2021  
Response Status Submitted  
Status Date 05/07/2021

XtraLight Manufacturing, Ltd.

Address 8812 Frey Road  
Houston, TX 77034 Participation Type: Active Supplier

Classifications TAS

Invitation Date 03/12/2021  
Invitation Type Automatic  
Invitation Email(s) Lisa.Proffit@xtralight.com susan.harte@xtralight.com  
Response Status Viewed  
Status Date 04/29/2021

Yes America Enterprises (Yes America Now, Inc)

Address 3776 Greenbriar Dr  
Stafford, TX 77474 Participation Type: Active Supplier

Classifications SBE (Primary)

Invitation Date 03/12/2021  
Invitation Type Automatic  
Invitation Email(s) yesamericaservices@gmail.com

YR Testing Account

Address 123 Street Name  
Everywhere, TX 77777 Participation Type: Active Supplier

Response Status Viewed  
Status Date 05/05/2021

Yucca Contracting

Address P.O. Box 13589  
El Paso, TX 79913 Participation Type: Active Supplier

Invitation Date 03/12/2021  
Invitation Type Automatic  
Invitation Email(s) maggie.vaquera@yahoo.com

Z FLOOR CO., LTD.

Address 350 BETCHAN AVENUE  
LAKE DALLAS, TX 75065 Participation Type: Active Supplier

Invitation Date 03/12/2021  
Invitation Type Automatic  
Invitation Email(s) sales@zfloor.com

Z Smart, LLC

---

Address 709 B West Rusk #813 Participation Type: Active Supplier  
Rockwall, TX 75087

Invitation Date 03/12/2021  
Invitation Type Automatic  
Invitation Email(s) Keith@ZSmartCo.com

---

Zapata Janitorial Building & General Service, Inc.

Address 10190 Old Katy Rd Participation Type: Active Supplier  
Houston, TX 77043

Classifications MBE (Primary)

Invitation Date 03/12/2021  
Invitation Type Automatic  
Invitation Email(s) zapatajanitorial@gmail.com

---

**Bid Activity Detail**

1st Advertisement

---

Activity Date 3/12/2021 09:00:00 AM (CT)  
Description

2nd Advertisement

---

Activity Date 3/15/2021 09:00:00 AM (CT)  
Description

Pre-Proposal Meeting (Optional)

---

Activity Date 3/25/2021 10:00:00 AM (CT)  
Description This will be held virtually through Zoom:  
Zoom Meeting

<https://zoom.us/j/92800094511?pwd=NDZCSDImOXRidTRINjdXdVY2RnlmZz09>

Meeting ID: 928 0009 4511

Passcode: 702350

One tap mobile

+13462487799,,92800094511#,,,,\*702350# US (Houston)

+16699006833,,92800094511#,,,,\*702350# US (San Jose)

Dial by your location

+1 346 248 7799 US (Houston)

+1 669 900 6833 US (San Jose)

+1 929 205 6099 US (New York)

+1 253 215 8782 US (Tacoma)

+1 301 715 8592 US (Washington DC)

+1 312 626 6799 US (Chicago)

Meeting ID: 928 0009 4511

Passcode: 702350

Find your local number: <https://zoom.us/u/abjiNtjLXF>

RS MEANS Beginner Training (Optional)

---

Activity Date 3/25/2021 11:00:00 AM (CT)

Description This beginner training is going to show you how to do your first line item estimate through RS MEANS Online.

This will be held virtually on Zoom.  
Zoom Meeting

<https://zoom.us/j/92800094511?pwd=NDZCSDImOXRidTRINjdXdVY2RnlmZz09>

Meeting ID: 928 0009 4511

Passcode: 702350

One tap mobile

+13462487799,,92800094511#,,,,\*702350# US (Houston)

+16699006833,,92800094511#,,,,\*702350# US (San Jose)

Dial by your location

+1 346 248 7799 US (Houston)

+1 669 900 6833 US (San Jose)

+1 929 205 6099 US (New York)

+1 253 215 8782 US (Tacoma)

+1 301 715 8592 US (Washington DC)

+1 312 626 6799 US (Chicago)

Meeting ID: 928 0009 4511

Passcode: 702350

Find your local number: <https://zoom.us/u/abjiNtjLXF>

Proposal Closes

---

Activity Date 5/7/2021 02:00:00 PM (CT)

Description

Anticipated Board Award

---

Activity Date 7/21/2021 02:00:00 PM (CT)

Description

**Regular Board Meeting**

**8.E.7.**

**Meeting Date:** July 21, 2021  
**Title:** Contract Award for 21/048SG for Promotional and Commemorative Items  
**Submitted For:** Joann Nichols, Choice Partners  
**Submitted By:** Cora Day  
**Recommended Action:** Approve  
**HCDE Goal(s):** 4. Provide cost savings by leveraging tax dollars

**Additional Resource Personnel:** Joann Nichols, Jeff Drury, Richard Vela, Yaritza Roman, Kendra Jackson and Dr. Jesus Amezcua  
**Facilities/Technology Approval Needed?:** None

**Information**

**Posted Agenda Item:**

**Approval of the Contract Award for job no. 21/048SG for Promotional and Commemorative Items with the following vendors:** 4imprint, Inc. (#21/048SG-01); Blink Marketing, Inc. (#21/048SG-02); Buffalo Specialties, Inc. (#21/048SG-03), and Liberty Data Products, Inc. dba Liberty Office Products (#21/048SG-04) for the period 07/21/2021 through 07/20/2022.

**Subject:**

Choice Partners; Contract Award; Promotional and Commemorative Items; Revenue Generating

**Rationale:**

The process enacted was Request for Proposal (RFP) to acquire proposals from vendors to provide Promotional and Commemorative Items to HCDE/Choice Partners members.

Eight hundred sixty-one (861) invitations were extended for proposals. Eighteen (18) responses were received from vendors. Each response was reviewed for compliance with the requirements of RFP no. 21/048SG. All responses that met the criteria and requirements of the RFP were evaluated and scored. Four (4) were determined to be non-responsive, ten (10) vendors were non-awarded, and four (4) vendors offering best value to HCDE/Choice Partners and its members were selected for award.

HCDE/Choice Partners recommends award of a one (1) year contract from 07/21/2021 to 07/20/2022 to the vendors stated above in Posted Agenda Item. Contract no. 21/048SG has the option for up to three (3) annual renewals. Anticipated revenue from contract no. 21/048SG will be an administrative fee of two percent (2%). This contract is governed by Texas Education Code 44.031.

**Fiscal Impact**

**Included in FY budget Y/N:** Y  
**Included in current budget amendment Y/N:** N

**Attachments**

Recommendation Report  
Evaluation Summary  
Participation Listing



Harris County Department of Education  
Choice Partners  
Proposal Recommendation Form  
Program Review

[This form is used to document due diligence by Recommendation Committee]

To: Kendra Jackson, HCDE Director of Purchasing  
From: Steve Gibson, Contract Manager, Choice Partners

Mary Causey, Contract Compliance Specialist, Choice Partners  
Kristi Nichols, Contract Manager, Choice Partners  
Stephen Kendrick, Senior Manager of Facilities Planning, HCDE

Job (Bid or RFP#) and Name: 21/048SG Addendum 1  
Promotional and Commemorative Items

Board Meeting Date: 7/21/2021  
Date: 6/9/2021

**Procurement Requirements Available:**

Check One

- Under \$2,500 (Requires Division Director and Asst Supt. Approval)
- From \$2,500 to \$50,000 (Requires Buyer, Purchasing Director/CFO Approval)
- Over \$50,000 (per CH Local)
- Cooperative Programs (Requires Board Approval)

I certify that I have reviewed the attached RFP and certify that all of my actions as a Recommendations Committee Member are within the procurement requirements in accordance with local Board Policies (CH local/legal) and legal (federal and state) policies and administrative guidelines set by the Business Office and Purchasing Division.

I certify that I have adhered to the Purchasing Policies of HCDE concerning the review of this RFP to include policies on conflict of interest (CIQ).

I certify that I am aware of all purchasing policies (CH Local and CH Legal) and administrative procedures of HCDE.

I certify that I am aware of the penalties of not following the purchasing policies and procedures and in specific with section 44.032 of the Texas Education Code which deals with the penalties related to sequential or component purchases.

I further certify that I recommend the execution of a contract after Board approval.

(Note: This form is required of all jobs (bids and RFPs) prepared by all buyers & directors.)

**Justification:**

(Any information that pertains to this job (bid or RFP))

21/048SG Addendum 1 Promotional and Commemorative Items

Choice Partners members will utilize this contract for Promotional and Commemorative Items

This contract will provide a discounted price, superior quality, and comply with state purchasing requirements as stated in TEC §44.031.

This job was competitively bid and advertised. The result of the bid generated the following responses:

Invitations were sent to	<u>861</u>	vendors
HCDE received	<u>18</u>	responses (see attached evaluation summary).

**Recommendation:**

HCDE is recommending contracts with Choice Partners Cooperative for 4imprint, Inc. , Blink Marketing, Inc. , Buffalo Specialties, Inc , and Liberty Data Products, Inc dba Liberty Office Products.





**Harris County Department of Education  
Choice Partners  
Instructions to Recommendation Committee**

**[This form is used to document due diligence by Recommendation Committee]**

---

**To:** Dr. Jesus J. Amezcua, CPA, Assistant Supt. for Business Services  
**From:** Steve Gibson, Contract Manager, Choice Partners  
**Job (Bid or RFP) # and Name:** 21/048SG Addendum 1  
Promotional and Commemorative Items  
**Board Meeting Date:** 7/21/2021  
**Today's Date:** 6/9/2021

Attached are the following materials for your review and possible recommendation to the Superintendent and the Board of Trustees:

Buyer Certification  
Bid Tabulation  
Copy of the Job (Bid or RFP) responses  
Set of Specs will be available for your review

Your responsibility for review of this job (bid or RFP) is to make sure that HCDE receives the best value for the goods and services sought. Please review the attached job (bid or RFP) and certify that all of the procurement requirements have been met in accordance with local Board Policies and legal (federal and state) policies and administrative guidelines set by the Business Office and the Purchasing Division.

Please remember to adhere to section 44.032 of the Texas Education Code, "Enforcement of Purchase Procedures: Criminal Penalties; Removal; Ineligibility" which deal with the penalties related to component, separate, and sequential purchases. In addition, Board policy CH Local and Legal are required to be met as part of your contractual obligation with HCDE.

It should be noted that if a required document is not provided by the bidder, the Purchasing Division will not be able to make a recommendation and or issue a purchase order.

Please review the responses to the job (bid or RFP) and submit the following forms by the required deadline for the next available Board Meeting:

**Signed Certification and Recommendation Form**

If any technicalities or changes need to be made, these must be addressed in the recommendation and presented as such to the Superintendent and the Board of Trustees.

**Agenda Item (Prepared by Buyer handling the job/bid or RFP)**

Once, a recommendation is approved by the Board, Choice Partners will issue an award letter and request that any pending bonds or contracts be submitted within 5 days to the District.



Harris County Department of Education  
Choice Partners  
Effectiveness and Compliance Review Form

**[This form is used to document due diligence by Recommendation Committee]**

To: Purchasing Audit File and Jesus J. Amezcua, CPA, Assistant Supt. for Business  
From Contract Manager: Steve Gibson, Contract Manager, Choice Partners  
Purchasing Dept: Kendra Jackson, Director  
  
Job- Bid or RFP# and Name: 21/048SG Addendum 1  
Promotional and Commemorative Items  
Board Meeting Date: 7/21/2021  
Date: 6/24/2021

**Procurement Requirements Available:**

Check One

\_\_\_\_\_ Under \$2,500 (Requires Division Director and Asst Supt. Approval)  
\_\_\_\_\_ From \$2,500 to \$50,000 (Requires Buyer, Purchasing Director/CFO Approval)  
\_\_\_\_\_ Over \$50,000 (per CH Local)  
\_\_\_\_\_ X \_\_\_\_\_ Cooperative Programs (Requires Board Approval)

I certify that I have reviewed the attached job (bid or RFP) and certify that all of my actions as a Recommendations Committee Member are within the procurement requirements in accordance with Local Board Policies (CH Local/Legal) and Legal (Federal and State) policies and administrative guidelines set by the Business Office and the Purchasing Division.

I certify that I have adhered to the Purchasing Policies of HCDE concerning the review of this job (bid or RFP) to include policies on conflict of interest.

I certify that I am aware of all purchasing policies (CH Local and CH Legal) and administrative procedures of HCDE.

I certify that I am aware of the penalties of not following the purchasing policies and procedures and in specific with section 44.032 of the Texas Education Code which deals with the penalties related to sequential or component purchases. I further certify that I recommend the issuance of a purchase order after Board approval and execution of a contract.

(Note: This form is required of all jobs (bids and RFPs) prepared by all buyers and directors.)

21/048SG Addendum 1

Promotional and Commemorative Items

Evaluation Criteria	Total Weighted Value	4imprint, Inc.	Authentic Promotions.com	Billy P Hidalgo, Jr.	Bay Promo LLC	Blink Marketing, Inc.
<b>Averages</b>						
(1) Price Overall Cost of Program Pricing as determined by the proposal submitted Pricing may also be based upon usage and coverage	40	26.67	28.67	26.67	20.67	32
(2) Vendor's experience and reputation References for local governmental entities and with a purchasing cooperative program Local government agencies within the past 5 years Other projects completed within the past 10 years	20	15.67	15.67	1.67	14.33	18.33
(3) Quality of Vendor's products/services and extent to which the products/services meet HCDE and HCDE members' needs: Project Management Infrastructure Solutions Quality of Vendor's Products/Service Demonstrated Ability to Perform	25	18.33	15	1.67	19.33	18
(4) Impact on the ability of HCDE members to comply with laws and rules relating to HUB/MWBE/SBE/PDBE/DBE	0	0	0	0	0	0
(5) Whether Vendor's financial capability is appropriate to the size and scope of the project and the total long-term cost to HCDE and HCDE members to acquire the products/service	5	5	4.33	0.67	2.67	5
(6) For a contract for goods and services, other than goods and services related to telecommunications and information services, building construction and maintenance, or instructional materials, whether the Vendor or the Vendor's ultimate parent company or majority owner: (A) has its principal place of business in this state; or (B) employs at least 500 persons in this state	0	0	0	0	0	0
(7) Vendor's past relationship with HCDE/CP	5	5	2.33	0	0	3
(8) Marketing Plan	5	4.33	3	2	1.67	4.33
<b>Total</b>	<b>100</b>	<b>75.00</b>	<b>69.00</b>	<b>32.68</b>	<b>58.67</b>	<b>80.66</b>

<p><b>Evaluators:</b> Mary Causey, Contract Compliance Specialist, Choice Partners Stephen Kendrick, Senior Manager of Facilities Planning, HCDE Kristi Nichols, Contract Manager, Choice Partners</p> <p><b>Non-Responsive</b> 4 <b>Non-Awarded</b> 10 <b>Award Threshold of 70</b> 4 <b>Total Responses</b> 18</p>	<p>Invitations were sent to 861 prospective bidders. Contracts are in accordance with TEC 44.031 It is recommended that the following awards of annual contracts:</p> <table border="0"> <tr> <td style="text-align: center;"><u>Contract</u></td> <td style="text-align: center;"><u>Vendor</u></td> </tr> <tr> <td>21/048SG-01</td> <td>4imprint, Inc.</td> </tr> <tr> <td>21/048SG-02</td> <td>Blink Marketing, Inc.</td> </tr> <tr> <td>21/048SG-03</td> <td>Buffalo Specialties, Inc</td> </tr> <tr> <td>21/048SG-04</td> <td>Liberty Office Products</td> </tr> </table>	<u>Contract</u>	<u>Vendor</u>	21/048SG-01	4imprint, Inc.	21/048SG-02	Blink Marketing, Inc.	21/048SG-03	Buffalo Specialties, Inc	21/048SG-04	Liberty Office Products
<u>Contract</u>	<u>Vendor</u>										
21/048SG-01	4imprint, Inc.										
21/048SG-02	Blink Marketing, Inc.										
21/048SG-03	Buffalo Specialties, Inc										
21/048SG-04	Liberty Office Products										

21/048SG Addendum 1

Promotional and Commemorative Items

Evaluation Criteria	Total Weighted Value	Brand IQ, LLC	Brandit LLC	Buffalo Specialties, Inc	Butler Business Products	Calfee Specialties
<b>Averages</b>						
(1) Price Overall Cost of Program Pricing as determined by the proposal submitted Pricing may also be based upon usage and coverage	40	27.33	<b>NR</b>	30.33	27.67	27.67
(2) Vendor's experience and reputation References for local governmental entities and with a purchasing cooperative program Local government agencies within the past 5 years Other projects completed within the past 10 years	20	16		16	10	14.33
(3) Quality of Vendor's products/services and extent to which the products/services meet HCDE and HCDE members' needs: Project Management Infrastructure Solutions Quality of Vendor's Products/Service Demonstrated Ability to Perform	25	14.67		18.33	17.67	14.33
(4) Impact on the ability of HCDE members to comply with laws and rules relating to HUB/MWBE/SBE/PDBE/DBE	0	0		0	0	0
(5) Whether Vendor's financial capability is appropriate to the size and scope of the project and the total long-term cost to HCDE and HCDE members to acquire the products/service	5	4		4.33	3.33	2.67
(6) For a contract for goods and services, other than goods and services related to telecommunications and information services, building construction and maintenance, or instructional materials, whether the Vendor or the Vendor's ultimate parent company or majority owner: (A) has its principal place of business in this state; or (B) employs at least 500 persons in this state	0	0		0	0	0
(7) Vendor's past relationship with HCDE/CP	5	4.33		3.67	5	2.67
(8) Marketing Plan	5	3		2.67	3.67	2.33
<b>Total</b>	<b>100</b>	<b>69.33</b>			<b>75.33</b>	<b>67.34</b>
<p><b>Evaluators:</b>  Mary Causey, Contract Compliance Specialist, Choice Partners  Stephen Kendrick, Senior Manager of Facilities Planning, HCDE  Kristi Nichols, Contract Manager, Choice Partners</p> <p>Invitations were sent to 861 prospective bidders.  Contracts are in accordance with TEC 44.031</p>						
<p><b>Non-Responsive</b> 4  <b>Non-Awarded</b> 10  <b>Award Threshold of 70</b> 4  <b>Total Responses</b> 18</p>						

21/048SG Addendum 1

Promotional and Commemorative Items

Evaluation Criteria	Total Weighted Value	Custom Sportswear, Inc.	Graphics Unlimited, Inc.	Laksh Corporation	Liberty Office Products	North Houston Athletics, LLC
<b>Averages</b>						
(1) Price Overall Cost of Program Pricing as determined by the proposal submitted Pricing may also be based upon usage and coverage	40	18.33	<b>NR</b>	27.67	30.33	20
(2) Vendor's experience and reputation References for local governmental entities and with a purchasing cooperative program Local government agencies within the past 5 years Other projects completed within the past 10 years	20	9.33		12.33	17.67	14
(3) Quality of Vendor's products/services and extent to which the products/services meet HCDE and HCDE members' needs: Project Management Infrastructure Solutions Quality of Vendor's Products/Service Demonstrated Ability to Perform	25	12		11.67	20	12.33
(4) Impact on the ability of HCDE members to comply with laws and rules relating to HUB/MWBE/SBE/PDBE/DBE	0	0		0	0	0
(5) Whether Vendor's financial capability is appropriate to the size and scope of the project and the total long-term cost to HCDE and HCDE members to acquire the products/service	5	3		2.33	5	4
(6) For a contract for goods and services, other than goods and services related to telecommunications and information services, building construction and maintenance, or instructional materials, whether the Vendor or the Vendor's ultimate parent company or majority owner: (A) has its principal place of business in this state; or (B) employs at least 500 persons in this state	0	0		0	0	0
(7) Vendor's past relationship with HCDE/CP	5	2.33		0	5	2.67
(8) Marketing Plan	5	3		2.33	4.33	3.33
<b>Total</b>	<b>100</b>	<b>47.99</b>			<b>56.33</b>	<b>82.33</b>
<p><b>Evaluators:</b>  Mary Causey, Contract Compliance Specialist, Choice Partners  Stephen Kendrick, Senior Manager of Facilities Planning, HCDE  Kristi Nichols, Contract Manager, Choice Partners</p> <p style="text-align: center;">Invitations were sent to 861 prospective bidders.  Contracts are in accordance with TEC 44.031</p> <p><b>Non-Responsive</b> 4  <b>Non-Awarded</b> 10  <b>Award Threshold of 70</b> 4  <b>Total Responses</b> 18</p>						

21/048SG Addendum 1

Promotional and Commemorative Items

Evaluation Criteria	Total Weighted Value	Riddell	Texas Music Festivals Enterprise, Inc	Trinity Enterprise Group LLC
<b>Averages</b>				
(1) Price Overall Cost of Program Pricing as determined by the proposal submitted Pricing may also be based upon usage and coverage	40	<b>NR</b>	<b>NR</b>	27
(2) Vendor's experience and reputation References for local governmental entities and with a purchasing cooperative program Local government agencies within the past 5 years Other projects completed within the past 10 years	20			2.33
(3) Quality of Vendor's products/services and extent to which the products/services meet HCDE and HCDE members' needs: Project Management Infrastructure Solutions Quality of Vendor's Products/Service Demonstrated Ability to Perform	25			3.67
(4) Impact on the ability of HCDE members to comply with laws and rules relating to HUB/MWBE/SBE/PDBE/DBE	0			0
(5) Whether Vendor's financial capability is appropriate to the size and scope of the project and the total long-term cost to HCDE and HCDE members to acquire the products/service	5			0
(6) For a contract for goods and services, other than goods and services related to telecommunications and information services, building construction and maintenance, or instructional materials, whether the Vendor or the Vendor's ultimate parent company or majority owner: (A) has its principal place of business in this state; or (B) employs at least 500 persons in this state	0			0
(7) Vendor's past relationship with HCDE/CP	5			0
(8) Marketing Plan	5			4.33
<b>Total</b>	<b>100</b>			
<b>Evaluators:</b> Mary Causey, Contract Compliance Specialist, Choice Partners Stephen Kendrick, Senior Manager of Facilities Planning, HCDE Kristi Nichols, Contract Manager, Choice Partners		Invitations were sent to 861 Contracts are in accordance with TEC 44.031		prospective bidders.
<b>Non-Responsive</b>	<b>4</b>			
<b>Non-Awarded</b>	<b>10</b>			
<b>Award Threshold of 70</b>	<b>4</b>			
<b>Total Responses</b>	<b>18</b>			

# Harris County Department of Education

## Participation Detail as of 6/24/2021 11:02:07 AM (CT)

### Bid Information

Bid Creator Mr. Steve Gibson Contract Manager  
 Email sgibson@hcde-texas.org  
 Phone 1 (713) 6816052  
 Fax

Bid Number 21/048SG Addendum 1  
 Title Promotional and Commemorative Items  
 Bid Type Request for Proposal  
 Issue Date 4/16/2021 04:39 PM (CT)  
 Close Date 5/18/2021 02:00:00 PM (CT)

### Participation Summary

Company Name	City, State	Invitation Date	Status	Status Date	Response Date
2 Inspire Peace	Dallas, TX	04/16/2021			
23 THRU ME LLC (23 THRU ME)	Houston, TX	04/16/2021			
2nd Nature Design Studio (Donavin Murray)	Houston, TX	04/16/2021			
2Tier Wholesalers	Garland, TX	04/16/2021			
3 Crafty Sisters	Greenville, TX	04/16/2021			
3 Oaks Resource Group International (Your School Resource Group, Inc.)	PINECREST, FL	04/16/2021			
365 Paving & Construction LLC	Mission, TX	04/16/2021			
4imprint, Inc.	Oshkosh, WI	04/16/2021	Submitted	05/12/2021	05/12/2021
5W Public Relations	New York, NY	04/16/2021			
A Plus Career Apparel	Burlingame, CA	04/16/2021			
A Plus Trophy (Carl B Andrews dba A Plus Trophy)	Humble, TX	04/16/2021			
A Sign of Quality	ROYSE CITY, TX	04/16/2021			
A&M Executive Services LLC	Dallas, GA	04/16/2021			
A+ Literacy Education And Development	Houston, TX	04/16/2021			
A1 SPORTS CENTER	SAN ANTONIO, TX	04/16/2021			
AAA Painting	Houston, TX	04/16/2021			
ABC Promos & Gifts	Milan, IL	04/16/2021			
Absolute Color Mailplex	Houston, TX	04/16/2021			
AC PRINTING, LLC	EULESS, TX	04/16/2021			
Accel Lifestyle, LLC.	Houston, TX	04/16/2021			
Ace Promotions	San Benito, TX	04/16/2021	Viewed	05/17/2021	
Ace T-Shirts	Pasadena, TX	04/16/2021			
Action Screen Graphics	Austin, TX	04/16/2021			
Addikshun Athletik Apparel (Dream Big Think Smart Marketing)	Houston, TX	04/16/2021			
Adele's Coaching and Consulting	Missouri City, TX	04/16/2021			
ADPOWER	Houston, TX	04/16/2021			
ADS Custom Signs, Inc.	Pasadena, TX	04/16/2021			
Advanced Graphics (MBR, Inc.)	Katy, TX	04/16/2021			
Advantage Business Products	Oregon City, OR	04/16/2021			
Advantage office products	Houston, TX	04/16/2021			
Advantage Supply	Fort Worth, TX	04/16/2021			
ADVENTURES IN LEARNING (Gregory Dale Laufer)	El Paso, TX	04/16/2021			
Ad-Wear and Specialty of Texas	Houston, TX	04/16/2021			
AFFORDABLE SIGNS	HUNTSVILLE, TX	04/16/2021			
AFP INDUSTRIES, INC.	SOUTH MIAMI, FL	04/16/2021			
AGAS MFG	Philadelphia, PA	04/16/2021	Viewed	05/12/2021	
AGH2O Holdings, LLC	Round Rock, TX	04/16/2021			
AHMS (Auto & Home Mobility Equipment)	College Station, TX	04/16/2021			
Aimgraphics (American Installation and Management, LLC)	Eules, TX	04/16/2021			
AJL Advertising Specialties, Inc.	Austin, TX	04/16/2021			

Alabama	Montgomery, AL	04/16/2021			
Alegna Technologies, Inc.	Kennesaw, GA	04/16/2021			
Algy Costumes & Uniforms (Algy Trimmings Co Inc)	Hallandale, FL	04/16/2021			
All About Events	Houston, TX	04/16/2021			
All Flag & Flagpoles, Inc.	East Setauket, NY	04/16/2021			
All Printing (All Print & Office supply)	Houston, TX	04/16/2021			
ALL VALLEY DRUG SCREENS	Brownsville, TX	04/16/2021			
Alliance Loose Leaf (JPS Alliance, Inc.)	Fort Worth, TX	04/16/2021			
Alliance Strategic Business Services, LP	Houston, TX	04/16/2021			
Allied Products Corporation	Kansas City, MO	04/16/2021			
Allied Signs	Houston, TX	04/16/2021			
AllTex Welding Supply, Inc.	Waller, TX	04/16/2021			
Alphagraphics 600 (A Dog Solutions)	San Antonio, TX	04/16/2021			
Alphagraphics of Conroe (Shakun Solutions, LLC)	Conroe, TX	04/16/2021			
Altius Graphics (NAYAK Corporation)	Houston, TX	04/16/2021			
AMAZING AWARDS INC	Houston, TX	04/16/2021			
AMC Promotional Products	ORLANDA, FL	04/16/2021	Viewed	05/11/2021	
America Team Sports	Richardson, TX	04/16/2021			
AMERICA'S BEST FLAGS AND FLAGPOLES	NEW BRAUNFELS, TX	04/16/2021			
American Aviation Services	Hockley, TX	04/16/2021			
American Flag Pole	Abingdon, VA	04/16/2021			
American Hotel Register Company	Vernon Hills, IL	04/16/2021			
American Medical Institute Inc (N/A)	Houston, TX	04/16/2021			
American Pride Paper and Plastic	Lakewood, NJ	04/16/2021			
AMERICAN SCREEN GRAPHICS	KINGWOOD, TX	04/16/2021			
American Specialty Advertising and Promotional Marketing LLC	Allen, TX	04/16/2021			
Ameritex Flag and Flagpole LLC	San Antonio, TX	04/16/2021			
Anderson Hydra Platforms, Inc.	York, SC	04/16/2021			
Andersons (Taymark)	Minneapolis, MN	04/16/2021			
Ann Marie Harbour	Richmond, TX	04/16/2021			
Anodizing Graphics of Texas (Durable Printed Products, Inc.)	Stafford, TX	04/16/2021			
Apollo Office Systems LLC	Alvin, TX	04/16/2021			
Aramark	Dallas, TX	04/16/2021			
Aramark Management Services Limited Partnership (Aramark SMMS LLC)	Philadelphia, PA	04/16/2021			
Arctic Guard	Katy, TX	04/16/2021			
Armor Gear	Rosharon, TX	04/16/2021			
ARRAY	Bellaire, TX	04/16/2021	Viewed	05/11/2021	
Artex Neu LLC	Houston, TX	04/16/2021	Unsubmitted	05/17/2021	
Artistic Awards, Inc. (Mark Leinen)	Dallas, TX	04/16/2021	Viewed	05/17/2021	
Ascend Performance Materials Operations LLC	Houston, TX	04/16/2021			
Astro Apparel & Uniforms	HOUSTON, TX	04/16/2021			
Astrov & Associates	Frisco, TX	04/16/2021			
Athletes World	Midland, TX	04/16/2021			
Atlantic Training	Middletown, DE	04/16/2021			
Atlas Embroidery LLC	Fort Lauderdale, FL	04/16/2021			
Authentic Promotions.com	Carmichael, CA	04/16/2021	Submitted	05/17/2021	05/17/2021
Aviva Wholesale (Nur International Inc)	Houston, TX	04/16/2021			
Award America	Spring, TX	04/16/2021			
AWARDS & ENGRAVING	BAYTOWN, TX	04/16/2021			
Awards by Gulf Coast Trophies	Pasadena, TX	04/16/2021	Unsubmitted	05/11/2021	
AWARDS OF DISTINCTION (AWARDS OF DISTINCTION, INC.)	HOUSTON, TX	04/16/2021			
B Hidalgo Industries Inc	Baytown, TX	04/16/2021	Submitted	05/17/2021	05/17/2021
Balance Sporting Goods	Marble Falls, TX	04/16/2021			
Balfour Company (Pride and Recognition)	Houston, TX	04/16/2021			
Balfour Yearbooks (Campus Impressions USA)	Dallas, TX	04/16/2021	No Bid	04/16/2021	05/06/2021
Barbara LaGatta Promotional Products Inc	San Antonio, TX	04/16/2021			
Barefoot (C&G Sporting Goods)	Stephenville, TX	04/16/2021			
BASIC OFFICE AND SCHOOL SUPPLY (RELIABLE OFFICE PRODUCTS, INC.)	HOUSTON, TX	04/16/2021			
Basil & Co. LLC	Houston, TX	04/16/2021			
BAY PROMO LLC	Tampa, FL		Submitted	05/18/2021	05/18/2021
BBeauti AndLashes LLC	Houston, TX	04/16/2021			



BDK And Associates LLC	Colleyville, TX	04/16/2021			
Be Sparkle (BSPARKLE LLC)	Baytown, TX	04/16/2021			
BE Staffing Solutions LLC	Houston, TX	04/16/2021			
Bee Busy Wellness Center	Houston, TX	04/16/2021			
Beehive Specialty	Austin, TX	04/16/2021			
Benchmark Displays, LLC	Palm Desert, CA	04/16/2021	Viewed	05/12/2021	
BG Technologies	Austin, TX	04/16/2021			
BGM Company	Houston, TX	04/16/2021	Viewed	05/11/2021	
Big Country School Supply LLC	Abilene, TX	04/16/2021			
Big Frog Custom T-Shirts & More	Houston, TX	04/16/2021			
BIG FROG OF THE WOODLANDS (Geoinvest Custom Garment, Inc)	Magnolia, TX	04/16/2021			
Big Hit Productions	Mesquite, TX	04/16/2021			
BIG MEDIA (VOSSEL INTERNATIONAL, INC.)	EL PASO, TX	04/16/2021			
Big Sister Little Sister	Houston, TX	04/16/2021			
Big Star Branding, Inc.	San Antonio, TX	04/16/2021			
BJ's Tees, LLC	San Marcos, TX	04/16/2021			
Blackland Glass & Construction	Greenville, TX	04/16/2021			
Blink Marketing Inc	Cleveland, OH	04/16/2021	Unsubmitted	05/21/2021	
Blink Marketing, Inc.	Franklin, TN	04/16/2021	Submitted	05/18/2021	05/18/2021
BLU PHIRE RESEARCH INSTITUTE INC	HOUSTON, TX	04/16/2021			
Blue Moose Tees (Bloose LLC)	Arlington, TX	04/16/2021			
BLUE RIBBON STYLES CO	BEDFORD PARK, IL	04/16/2021			
Blue Wave Apparel	Pinehurst, TX	04/16/2021			
BluGreen Pest Control	Wallis, TX	04/16/2021			
BMP Vision	Houston, TX	04/16/2021			
BNP Creations	Kemah, TX	04/16/2021			
Bolo Stick LLC	Warren, OH	04/16/2021			
Bonheur Embroidery	Justin, TX	04/16/2021			
BookerDezigns	Richmond, TX	04/16/2021			
Boost Promotions	Draper, UT	04/16/2021			
Boss & Hughes	Houston, TX	04/16/2021	Viewed	05/13/2021	
Boundless Network	Austin, TX	04/16/2021			
Brady Hull & Associates, L.C.	The Woodlands, TX	04/16/2021			
Brame Specialty Company Inc.	Durham, NC	04/16/2021			
Brand IQ, LC	Webster, TX	04/16/2021	Submitted	05/17/2021	05/17/2021
Brandit LLC	McAllen, TX	04/16/2021	Submitted	05/18/2021	05/18/2021
BRANDMARK	Edinburg, TX	04/16/2021			
Brandwurx (Black Loyal)	Phoenix, AZ	04/16/2021			
Brentwood Marketing, LLC	Spring, TX	04/16/2021			
Briar Patch	Houston, TX	04/16/2021			
BRIDGEFARMER'S INC	round rock, TX	04/16/2021			
Brigitte DeJohn	Dayton, TX	04/16/2021			
Brookside Specialties (Together, Inc.)	Tulsa, OK	04/16/2021			
Brucelli Advertising	Dunmore, PA	04/16/2021			
BSN Sports, LLC (Varsity Brands Holding Co., Inc.)	Dallas, TX	04/16/2021			
Buffalo Specialties, Inc	Houston, TX	04/16/2021	Submitted	05/03/2021	05/03/2021
BuildASign	Austin, TX	04/16/2021			
BullShirts, Inc	Houston, TX	04/16/2021			
Butler Business Products, LLC	Houston, TX	04/16/2021	Submitted	05/18/2021	05/18/2021
Byfaith Design (Darnell Caldwell)	Dallas, TX	04/16/2021			
C&H Distributors, LLC	Milwaukee, WI	04/16/2021			
C2 Imaging	Houston, TX	04/16/2021			
Calfee Specialties (BLUE RIBBON PROMOTIONS LLC)	Conroe, TX	04/16/2021	Submitted	05/18/2021	05/18/2021
California	West Sacramento, CA	04/16/2021			
Camelback Displays Inc.	Spring, TX	04/16/2021			
Capitol Flag Co., Inc.	Houston, TX	04/16/2021			
Caprice Productions, Inc	San Antonio, TX	04/16/2021			
Career Uniforms (Radia Enterprises Inc)	Houston, TX	04/16/2021			
Carlisle Life Products LLC	Houston, TX	04/16/2021			
Carney Educational Services	Glendale, CA	04/16/2021			
CAROLINA INDUSTRIAL MAT CO., INC	THOMASVILLE, NC	04/16/2021			
Cassidel Crative Embroidery Designs (Cassie Mitchell)	Houston, TX	04/16/2021			
Catalyst PR INC	Conroe, TX	04/16/2021	Viewed	05/11/2021	

Cedar Promo (PS Promotional Solutions LLC)	Dallas, TX	04/16/2021			
Celebrate Student Success, LLC	Katy, TX	04/16/2021			
Central IT Company LLC	Houston, TX	04/16/2021			
CFJ Manufacturing	Fort Worth, TX	04/16/2021			
Challenge Office Products	Houston, TX	04/16/2021	Unsubmitted	05/12/2021	
CHAMPION AWARDS	Weslaco, TX	04/16/2021			
Champion Teamwear (It's Greek To Me, Inc)	Manhattan, KS	04/16/2021	No Bid	05/18/2021	05/18/2021
Chase in Dreams, Speech and Drama (Deadra Chase)	Houston, TX	04/16/2021			
Cheatham & Associates Corp	Addison, TX	04/16/2021			
Cheerleading Company (Movie Show Video Mgt., Inc.)	Dallas, TX	04/16/2021			
Cheers, Etc., Inc.	Garland, TX	04/16/2021			
Child Care Associates	FORT WORTH, TX	04/16/2021			
Child Safety Solutions	Rockland, ME	04/16/2021			
Christian Brothers Tees	Lewisville, TX	04/16/2021			
CIELO VISTA UNLIMITED LLC (CIELO VISTA UNIFORMS & MORE)	HOUSTON, TX	04/16/2021			
cleaningessence LLC	HOUSTON, TX	04/16/2021			
Clever Items	Arlington, TX	04/16/2021			
Club Colors Buyer LLC	Schaumburg, IL	04/16/2021			
CME Printing, Inc.	Houston, TX	04/16/2021			
Coach Mercer LLC	Katy, TX	04/16/2021	Viewed	05/17/2021	
Coastal Enterprises (Joy Products of California, Inc)	Fountain Valley, CA	04/16/2021			
Coastal Office Solutions	Victoria, TX	04/16/2021			
Cole Enterprise LLC (IGWT Partners)	Murfreesboro, TN	04/16/2021			
Comflow Mechanical Services	Houston, TX	04/16/2021			
CompuPro Global (Rita's Tape Media)	Houston, TX	04/16/2021			
Concept uniform co	Homestead, PA	04/16/2021			
Connecticut	Hartford, CT	04/16/2021			
ConServ Flag Company	Sidney, NE	04/16/2021			
Construction Journal	Stuart, FL	04/16/2021			
Copy Stop Print and Postal (Texas Printing and Publishing)	Bryan, TX	04/16/2021			
Corporate Incentives, Inc	The Woodlands, TX	04/16/2021	Unsubmitted	05/11/2021	
Council Rock Enterprises, LLC	Rochester, NY	04/16/2021			
Creative Concepts Printing, Graphics	Houston, TX	04/16/2021			
Crestline Co Inc (Crestline Specialties Inc)	Lewiston, ME	04/16/2021			
Crestline Specialties Inc	Lewiston, ME	04/16/2021			
Crown Trophy (Seabrook Trophy & Awards)	Seabrook, TX	04/16/2021			
Cryogenic Plastics dba Pageantry World (Cryogenic Plastics Inc.)	Kyle, TX	04/16/2021			
Curtis 1000	Duluth, GA	04/16/2021			
CUSTOM CREATIONS	Baytown, TX	04/16/2021			
Custom Pins, Inc.	Rye Brook, NY	04/16/2021			
CUSTOM SPORTSWEAR, INC.	SEWELL, NJ	04/16/2021	Submitted	04/28/2021	04/28/2021
Custom Wall Prints & More, LLC	Houston, TX	04/16/2021			
Cyclone FPV (Cyclone 3D, Inc.)	Spring, TX	04/16/2021	Viewed	05/16/2021	
Cypress Station Shipping and Digital Print Solutions (united networking community)	Houston, TX	04/16/2021			
D.A.N.'s One Stop, LLC.	Shreveport, LA	04/16/2021			
D3 & Sons Services	Magnolia, TX	04/16/2021			
Daintree Solutions LLC	Richmond, TX	04/16/2021			
Dance Another World	Austin, TX	04/16/2021			
Daniel's Printing Place	Weslaco, TX	04/16/2021			
DataSpan (MRI Inc)	Graham, TX	04/16/2021			
David & Co.	Dallas, TX	04/16/2021			
DBS Marketing & Promotions LLC	Magnolia, TX	04/16/2021			
DBS Texas-Houston	deer park, TX	04/16/2021			
Delaware	Dover, DE	04/16/2021			
Delta Signs and Flags	Glendale, NY	04/16/2021			
DEMCO, Inc.	Madison, WI	04/16/2021			
Dent Enterprises LLC	DeSoto, TX	04/16/2021			
Descon Signage Solutions (Young & Kenady Inc.)	Brownsburg, IN	04/16/2021			
Design 3 Graphics	Spring, TX	04/16/2021			
Design A Tee of Fortbend	houston, TX	04/16/2021			

DG Grafix	Houston, TX	04/16/2021		
DGR United	houston, TX	04/16/2021		
DGS Educational Products	Delray Beach, FL	04/16/2021		
Diamond S. Spiritwear (Elan Industries)	Irving, TX	04/16/2021		
Diann Zackery dba: The Lysander Element	Grapeland, TX	04/16/2021		
DIBSYS Inc	Naperville, IL	04/16/2021		
Discount Copy (Loaiza Enterprises Inc)	Houston, TX	04/16/2021		
Discovery Education Resources (Discovery Education Resources, LLC)	Fort Worth, TX	04/16/2021		
Display Graphics, Inc	Houston, TX	04/16/2021		
Dive Quarters Inc	Virginia Beach, VA	04/16/2021		
Diversified Supply HUB (LP Diversified Supply Hub)	Aledo, TX	04/16/2021		
Dixie Flag and Banner Company	SAN ANTONIO, TX	04/16/2021		
DL Stone Enterprises, LLC (Stone Enterprises)	Garden Ridge, TX	04/16/2021		
DNH PROMOTIONAL MARKETING	Houston, TX	04/16/2021		
DOLPHIN GRAPHICS INC	HOUSTON, TX	04/16/2021		
Double J Embroidery	Montgomery, TX	04/16/2021		
Dragonfly Garment & Design Corporation	Seguin, TX	04/16/2021		
Dream Catcher Learning Academy	Humble, TX	04/16/2021		
Dynamic Designs (Killeen Dynamic Designs, Inc.)	Killeen, TX	04/16/2021		
Eagle Flags Co (American Eagle Trading Inc)	Houston, TX	04/16/2021		
Eagle Mountain Flag & Flagpole (Eagle United USA, Inc.)	Wimberley, TX	04/16/2021		
East Texas T-Shirts & More (T&S Creative Designs)	Onalaska, TX	04/16/2021		
Eastbay	Wausau, WI	04/16/2021		
Echo Office Products	Houston, TX	04/16/2021		
Educate To Edify (Educating While Black)	Pearland, TX	04/16/2021		
Educational Products, Inc.	Houston, TX	04/16/2021		
EDUCATORS DEPOT INC	SUGAR LAND, TX	04/16/2021		
Eillac Supply CO (Ricky Small)	Houston, TX	04/16/2021		
EL PASO BOLT & SCREW CO., INC	El Paso, TX	04/16/2021		
Electric Bluebird Printing	Willis, TX	04/16/2021		
Elementary Spirit Zone	Denton, TX	04/16/2021		
Elgin School Supply Co, Inc	Chico, CA	04/16/2021		
Elite Flags and Poles, Inc.	Cypress, TX	04/16/2021		
Elite Printing (Elite Promotional Printing, Inc.)	Houston, TX	04/16/2021		
ELITE PROMOTIONS (Rossy Galarza)	brownsville, TX	04/16/2021	Unsubmitted	05/11/2021
E-Logic, Inc.	Washington, DC	04/16/2021		
ELP Enterprises, Inc	Houston, TX	04/16/2021		
Embellish Athletics (Embellish by Best of the West Designs)	Wylie, TX	04/16/2021		
Embroidery Creations LLC	San Antonio, TX	04/16/2021		
EmbroidMe Corpus Christi (Ofelia P. Rios, Inc.)	Corpus Christi, TX	04/16/2021		
EmbroidMe Kingsville (Gihon, Inc)	Kingsville, TX	04/16/2021		
EmbroidMe Northwest Houston (Holliman-Wrenn, Inc.)	Houston, TX	04/16/2021		
Embroidme Webster (DBH Innovations, Inc.)	Webster, TX	04/16/2021		
EMC Resurfacing	San Antonio, TX	04/16/2021		
Empowered Network Services, LLC	Huffman, TX	04/16/2021		
EMRJ Marketing	Spring, TX	04/16/2021		
EneSportz	Pearland, TX	04/16/2021		
Entourage Yearbooks (Entourage Imaging)	Princeton Junction, NJ	04/16/2021		
Equinox Marketing	HOUSTON, TX	04/16/2021		
ERI	Harlingen, TX	04/16/2021		
Escamilla & Poneck, LLP	San Antonio, TX	04/16/2021		
Esix Sportswear Inc.	Arlington, TX	04/16/2021		
Euphoria Bridal/AdvanceHospitalUniforms	Duncanville, TX	04/16/2021		
Evco Partners LP dba Burgoon Company	Galveston, TX	04/16/2021		
Exalt Printing Solutions (Exalt Printing Solutions, LLC)	Carrollton, TX	04/16/2021		
ExerPlay, Inc	Cedar Crest, NM	04/16/2021		
EXIMIUS COFFEE LLC	HOUSTON, TX	04/16/2021		
Exotic Creations	Missouri City, TX	04/16/2021		
Express Children's Theatre	Houston, TX	04/16/2021		
Express Press	Springfield, MO	04/16/2021		

FASTSIGNS - Irving (Outstanding Graphic Solutions, Inc.)	Irving, TX	04/16/2021		
FASTSIGNS (BTB Signs LP)	Houston, TX	04/16/2021		
FASTSIGNS 2073	GALVESTON, TX	04/16/2021		
Fifty Shades of Graphics (Sport Your Gear LLC)	New Caney, TX	04/16/2021		
Final Graphic	Pantego, TX	04/16/2021		
First Team Athletic Apparel (First Team Athletic Apparel, LLC)	Jefferson, LA	04/16/2021		
First to the Finish	Carlinsville, TX	04/16/2021		
Florida	Tallahassee, FL	04/16/2021		
Forever Blossom, LLC	Houston, TX	04/16/2021		
Forever Divine	Bowie, TX	04/16/2021		
Fors Lux Group (Fors Lux Group Corporation)	Houston, TX	04/16/2021		
Fort Worth Hightech Signs Company	Fort Worth, TX	04/16/2021		
Fort Worth Running Company (Kevin P. Simms LLC)	Pasadena, TX	04/16/2021		
Forte Advertising, LLC	Denver, AL	04/16/2021		
Fostering Stars Learning & Resource Center, Inc	Houston, TX	04/16/2021		
FR Girls of Texas	Van, TX	04/16/2021		
Francis Communications Inc.	Nashville, TN	04/16/2021		
FSP Designs (Matthew Geiger)	Monrovia, CA	04/16/2021	Unsubmitted	05/16/2021
Fully Promoted of Magnolia, Tx (Owner)	Magnolia, TX	04/16/2021		
Fundraising Forever	Katy, TX	04/16/2021		
Funkytown Threads (Gary Lawrence)	Richland Hills, TX	04/16/2021		
G & G Sign Studio LLC	Corpus Christi, TX	04/16/2021		
G & K Services	MN, MN	04/16/2021		
GA ADVERTISING (FIDELFO LOZANO JR)	LAREDO, TX	04/16/2021		
Gameday Sports Apparel	Grapevine, TX	04/16/2021		
Garden State Highway Products, Inc.	Millville, NJ	04/16/2021		
Gateway Printing & Office Supply, Inc.	San Antonio, TX	04/16/2021		
Gazelle Capital, LLC	Saint Petersburg, FL	04/16/2021		
GBI INK / PRINTING & PROMOTIONS (GBI ENTERPRISES)	CONROE, TX	04/16/2021		
GBPDIRECT (dean)	Kenner, LA	04/16/2021		
Geaux Crates & Storage, LLC	Houston, TX, TX	04/16/2021		
Gene's Machine, INC.	Victoria, TX	04/16/2021		
Get Brand Out	New York, NY	04/16/2021		
Getting Sorted (G. Yess Fisher & Co., LLC)	The Woodlands, TX	04/16/2021		
Glad Rags	Dayton, TX	04/16/2021		
Gladius WPTB	tampa, FL	04/16/2021		
Glendale Parade Store, LLC	SAN ANTONIO, TX	04/16/2021		
Global Equipment Company Inc. (Global Industrial, Global Industrial Equipment)	Buford, GA	04/16/2021		
Global Safety Solutions	Deer Park, TX	04/16/2021		
Global Xpress Promotions (GXP Ventures, LLC)	Dallas, TX	04/16/2021		
Globe Electric Supply (Globe Electric Supply, Inc.)	Houston, TX	04/16/2021		
Globe Office Products	Houston, TX	04/16/2021		
Golden Gate	Ansan, Gyeonggi-do		Viewed	05/11/2021
Golden Mountain Consulting L.L.C	Houston, TX	04/16/2021		
Graduate Sales & Recognition	Spring, TX	04/16/2021		
Graphic Solutions Inc	hixson, TN	04/16/2021		
Graphics Store	Fort Worth, TX	04/16/2021		
Graphics Unlimited, Inc.	Crosby, TX	04/16/2021	Submitted	05/14/2021 05/14/2021
Green Mango Marketing	Conroe, TX	04/16/2021		
GreenGo 2020	Houston, TX	04/16/2021		
Greenwood Office Outfitters	Fort Worth, TX	04/16/2021		
Groggy Dog Sportswear & Graphics Design	Denton, TX	04/16/2021		
Ground Zero Marketing	Folsom, CA	04/16/2021		
Grunwald Printing Company, Inc.	Corpus Christi, TX	04/16/2021		
GT Distributors, Inc.	Austin, TX	04/16/2021		
Gulf Coast Athletic Supply	Sugar Land, TX	04/16/2021		
Gulf Coast Nut & Bolt LLC	Corpus Christi, TX	04/16/2021		
Gurrola Reprographics Inc.	Houston, TX	04/16/2021		
H.D.I.	Houston, TX	04/16/2021		
Hakimee Signs	Houston, TX	04/16/2021		
Halo Branded Solutions Inc.	Sterling, IL	04/16/2021	Viewed	05/11/2021

HAMMOND & STEPHENS (A DIVISION OF PREMIER AGENDAS INC)	FREMONT, NE	04/16/2021		
Hammond Greetings and Promotions	San Antonio, TX		Viewed	05/11/2021
Harcourt Outlines (Harcourt Industries, Inc.)	Milroy, IN	04/16/2021		
Harvey-Daco, Inc. (Harvey Advertising Company)	Waco, TX	04/16/2021		
HCONE International IMPEX Inc (Enoch Kabutey)	Houston, PA	04/16/2021		
Healy Awards, Inc	Menomonee Falls, WI	04/16/2021		
Heart Nation Inc	Humble, TX	04/16/2021		
Heart to Heart Advettising & Awards	Beaumont, TX	04/16/2021		
Heavenly Service, LLC	Webster, TX	04/16/2021		
Hercules Poly	Eclectic, AL	04/16/2021		
Heritage Treasures Screen Print and Embroidery (Heritage Treasures, LLC)	Sterling, VA	04/16/2021		
Hill Country Screen Printing & Embroidery	Fredericksburg, TX	04/16/2021		
Hooper Strategies	Granbury, TX	04/16/2021		
Horns Crew Trucking (Alvin Horn)	Longview, TX	04/16/2021		
Houston Astros	Houston, TX	04/16/2021		
Houston Event Photography	League City, TX	04/16/2021		
Houston Graduation Center, INC. (Herff Jones)	Houston, TX	04/16/2021		
Houston Modular Installation	Houston, TX	04/16/2021		
Houston Printing (DFS Print LLC)	Houston, TX	04/16/2021		
Houston Urban Debate League	Houston, TX	04/16/2021		
HSDesigns (Hector T. Siordia)	Austin, TX	04/16/2021		
Hula Signworks	Oak Ridge North, TX	04/16/2021		
HUSTLE T-SHIRT COMPANY (HUSTLE T-SHIRT COMPANY, LLC)	CONROE, TX	04/16/2021		
Hype Socks, LLC	Columbus, OH	04/16/2021		
HYQUAL PROMOTIONS, LLC	STAFFORD, TX	04/16/2021		
I AM Transition Community Foundation, Inc.	Humble, TX	04/16/2021		
IC Print Signs Promo	Argyle, TX	04/16/2021		
ICC Thermal Mapping and Data Analytcs (Infrared Concepts Corporation)	Maitland, FL	04/16/2021		
ICI Construction, Inc.	Spring, TX		Viewed	05/17/2021
ICS JAIL SUPPLIES, INC	Waco, TX	04/16/2021		
id Screen Print, LLC	Houston, TX	04/16/2021		
Identity Plus LLC	Houston, TX	04/16/2021		
Illinois	Chicago, IL	04/16/2021		
Imprezos Pro Uniforms LLC	Pharr, TX	04/16/2021		
Imprint Resources	Richardson, TX	04/16/2021		
Indiana	Indianapolis, IN	04/16/2021		
Industrial Air Tool (PSS Industrial Group Corp)	Pasadena, TX	04/16/2021		
Info Technology Supply Ltd	Chicago, IL	04/16/2021		
Infojini, Inc.	Columbia, MD	04/16/2021		
inkDOTS Printing Solutions	Houston, TX	04/16/2021		
InnerChange Consulting Group	Houston, TX	04/16/2021		
InnovsiteLLC	Decatur, GA	04/16/2021		
Insight Branding (Tarheel Promotions)	Charlotte, NC	04/16/2021		
Institute for Building Technology and Safety	VA, VA	04/16/2021		
InsulFab (Concote Corporation)	Coppell, TX	04/16/2021		
Integrity Pipeline Services	Pearland, TX	04/16/2021		
Interactive Robotics (Bayou City fencing Academy)	Houston, TX	04/16/2021		
International Corporate Apparel, Inc.	Tucson, AZ	04/16/2021		
International Promotional Ideas Inc.	Elk Grove Village , IL	04/16/2021		
Intex United	Houston, TX	04/16/2021		
Iowa State	Des Moines, IA	04/16/2021		
IQ Total Source, LLC	Houston, TX	04/16/2021		
IS Creative Graphics	Sugar Land, TX	04/16/2021		
J. Harding & Co. (J W Drouin & Assoc.)	Houston, TX	04/16/2021		
JADavis Advertising	Channelview, TX	04/16/2021		
JAMYKY LLC	Sugar Land, TX	04/16/2021		
JAVACCS, LLC	Humble, TX	04/16/2021		
Jaycee Rose Photography	New Waverly, TX	04/16/2021		
JC Apparel & More, LLC	Pearland, TX	04/16/2021		
Jeff's Mechanical Service	Houston, TX	04/16/2021		
JERICO FOUNDATION REPAIR	HOUSTON, TX	04/16/2021		
JOSTENS (Gardner Seaholm & Associates, LLC)	Spring, TX	04/16/2021		

Jostens Inc.	Minneapolis, MN	04/16/2021	Viewed	05/11/2021	
Journeys Managing Group LLC	Houston, TX	04/16/2021			
Joy Professional Promotional Products, LLC	FREEPORT, NY	04/16/2021			
Just Right Products DBA FW Promo	Haltom City, TX	04/16/2021			
Kahuna Flowers Inc. (The Kukui Nut Co)	Mckinney, TX	04/16/2021			
Kaleidoscope School Uniforms (KSU, LLC)	Houston, TX	04/16/2021			
KANKO (Floyd's Chores & Odd Jobs)	Dallas, TX	04/16/2021			
Kansas	Topeka, KS	04/16/2021			
Karsons Clothier	dallas, TX	04/16/2021			
Kids N Care	Houston, TX	04/16/2021			
Kiln Services of North Texas	Highland Village, TX		Viewed	05/11/2021	
Kimble Hair Studio	Los Angeles, CA	04/16/2021			
Kingham Dalton Wilson, Ltd.	Houston, TX	04/16/2021			
KJH Consultant Services (Karla J. Horn)	Houston, TX	04/16/2021			
KLAS Products, Inc. (KLAS Products, Inc)	McKinney, TX	04/16/2021			
KLD PLAYSCAPES USA (TWO WORD COMPANY LLC)	Boca Raton, FL	04/16/2021			
KMD Hospitality (KMD Hospitality LLC)	Humble, TX	04/16/2021			
KMSCO Inc	Ocean, NJ	04/16/2021			
Konnecting the Dots	Houston, TX	04/16/2021			
Krom Apparel (Jeffrey M. Oberkrom)	Denton, TX	04/16/2021			
Kronberg's Flags and Flagpoles (Associated Builders Specialties, Inc.)	Houston, TX	04/16/2021			
KS Phlebotomy School, LLC	Houston, TX	04/16/2021			
Ksee Designs (Seeds and Water) (Ksee Designs)	Kingwood, TX	04/16/2021			
KWIK KOPY PRINTING (KLASSIC PRINTING LLC)	HOUSTON, TX	04/16/2021			
LABSOURCE INC	NORTHLAKE, IL	04/16/2021			
Lady Liberty Flag & Flagpole (Convict Hill Floorcovering & Design Inc)	Austin, TX	04/16/2021			
Lady Liberty Group LLC	Eules, TX	04/16/2021			
Laksh Corporation	Flower Mound, TX	04/16/2021	Submitted	05/12/2021	05/12/2021
LaserMaxx (Rafter V Enterprises, LLC)	La Grange, TX	04/16/2021			
Launch Point CDC, Inc.	Houston, TX	04/16/2021			
Lavish Designs LLC	La Porte, TX	04/16/2021	Viewed	05/11/2021	
Lazer Custom Apparel	Allen, TX	04/16/2021			
Learning Tools (Aurora L Hart)	Humble, TX	04/16/2021			
Learning Zone (Kimco Educational Products, INC)	San Antonio, TX	04/16/2021			
Levy's Tutorial and Enrichment Center (Mary Baumann)	Houston, TX		No Bid	05/04/2021	05/04/2021
Liberty Flags, Inc.	Tulsa, OK	04/16/2021			
Liberty Office Products (Liberty Data Products, Inc)	Houston, TX	04/16/2021	Submitted	05/18/2021	05/18/2021
Lighthouse Groups LLC	Saint Louis, MO	04/16/2021			
Liquid Studio Group	Laredo, TX	04/16/2021			
Lloyd Schuh Co., Inc. dba LSC Promos	Little Rock, AR	04/16/2021			
LONE STAR FLAGS & FLAGPOLES INC.	Stafford, TX	04/16/2021			
Lone Star Flags & Flagpoles, Inc.	Galveston, TX	04/16/2021			
lone star uniforms	houston, TX	04/16/2021			
Lovebundles4ever LLC	Jonesboro, GA	04/16/2021			
Lowes Companies Inc	Mooreville, NC	04/16/2021			
LP Printing ( Long Plan Printing ) (Long Plan Printing)	Houston, TX	04/16/2021			
LQI Consulting Group, LLC	Round Rock, TX	04/16/2021			
M & M Apparel (Graff Gand Monograms & More)	College Station, TX	04/16/2021			
M&H Lighting Systems (Mapenzi Group)	Pearland, TX	04/16/2021			
M.E.N. (Mentoring, Educating & Nurturing) Incorporated (MEN Inc.)	Houston, TX		No Bid	05/15/2021	05/15/2021
macleem sports wear	Jersey City, NJ	04/16/2021			
MadPen Designs	Conroe, TX	04/16/2021			
Magnolia Park Arts & Community	Houston, TX	04/16/2021			
Main Stop Testing Svcs	Houston, TX	04/16/2021			
MAINLAND SUPPLY	San Marcos, CA	04/16/2021			
MAKEDA GROUP AND ASSOCIATES	HOUSTON, TX	04/16/2021			
Malor & Company Inc	New York, NY	04/16/2021			
Manning's Office Solutions (Manning's)	Beaumont, TX	04/16/2021			
Marfield Corporate Statinery (Marfield, Inc.)	Carrollton, TX	04/16/2021			

MarketExpo.com (Gerlach Inc.)	Indian Rocks Beach, FL	04/16/2021		
Marketing Magic International LTD	League City, TX	04/16/2021		
MARY LOUS TWIRLERS & DRILL TREAM (TERRY LYNN DAVIS)	HOUSTON, TX	04/16/2021		
Masks.com	Lago Vista, TX	04/16/2021		
Massachusetts	Boston, MA	04/16/2021		
Master Jiu-jitsu Academy (Master Jiu-jitsu Academy LLC)	HOUSTON, TX	04/16/2021		
Mata Boxing Promotions- MBP (Jason Mata)	SAN ANTONIO, TX	04/16/2021		
MAVICH	Southlake, TX	04/16/2021		
Max Marketing Company	Conroe, TX	04/16/2021		
Mayo's Printing & Awards	Houston, TX	04/16/2021		
MCS Enterprises	Houston, TX	04/16/2021		
MECA Sportswear	Tomah, WI	04/16/2021	Viewed	05/11/2021
Metromarketing Services, Inc.	Houston, TX	04/16/2021		
Midwest Office Furniture Inc (Midwest Office Supply)	Wichita Falls, TX	04/16/2021		
Mighty Moose Screen Printing (Paramount Printing)	Rosenberg, TX	04/16/2021		
MINIXMEDIA	PORT ARTHUR, TX	04/16/2021		
Minnesota	St. Paul, MN	04/16/2021		
Minuteman Press (KERS Enterprises, L.L.C.)	Friendswood, TX	04/16/2021		
Miracle Method of Austin (Nartor Associates Inc)	Austin, TX	04/16/2021		
Mirror Print Solutions	Missouri City, TX	04/16/2021		
Mississippi	Jackson, MS	04/16/2021		
Missouri	Jefferson City, MO	04/16/2021		
Mixxdd Marketing	Kenedy, TX	04/16/2021		
ModFit Apparel	Forney, TX	04/16/2021		
Moments Etc.	Cypress, TX	04/16/2021		
Monarch Trophy Studio (Drago Investments LTD)	San Antonio, TX	04/16/2021		
Mondor Ltd	saint-jean-sur-Richelieu, QC	04/16/2021		
M-Pak, Inc.	Aledo, TX	04/16/2021		
Mpressa (Sabre Technologies)	Houston, TX	04/16/2021		
MSC Industrial Supply (Sid Tool Co.)	Melville, NY	04/16/2021		
MTM Recognition Corporation	Oklahoma City, OK	04/16/2021	Viewed	05/11/2021
MTS	Belmont, MS	04/16/2021		
Mufasa's Pride Rites of Passage	Houston, TX	04/16/2021		
Murphy Robes (Herff Jones LLC)	Champaign, IL	04/16/2021		
Music in Motion	Plano, TX	04/16/2021		
MV Corp (David Peyser Sportswear)	Bay shore, NY	04/16/2021		
MWH PUBLIC RELATIONS	HOUSTON, TX	04/16/2021		
My Flag, USA (Monty Cazier)	PALESTINE, TX	04/16/2021		
MYBINDING.COM (INFORMATION MANAGEMENT SERVICES)	HILLSBORO, OR	04/16/2021		
myMatrixx	Tampa, FL	04/16/2021		
Namifiers, LLC	Springville, UT	04/16/2021		
Namitzi Yoga (Mitzi Henderson)	HOUSTON, TX	04/16/2021		
National Recognition Products - Gulf Coast	Humble, TX	04/16/2021		
NBD Graphics Inc	Katy, TX	04/16/2021		
NERDY BIRDIE (ENOVATEKK)	SPRING, TX	04/16/2021		
Net Results (Larry Rosenbaum)	Arlington, VA	04/16/2021		
New Spectrum Educational Consultants (Civil Society Educational Consultants)	Houston, TX	04/16/2021		
New Way Printing	Willis, TX	04/16/2021		
New York	New York, NY	04/16/2021		
Newbart Products, Inc.	Houston, TX	04/16/2021		
NEXT LEVEL GRAPHIX	KATY, TX	04/16/2021		
Nfinity Athletic	Atlanta, GA	04/16/2021		
NH MEASURES, LLC	KATY, TX	04/16/2021		
Night Owls Print Shop	Houston, TX	04/16/2021		
no bully here	PASADENA, TX	04/16/2021		
NO EGO APPAREL (NO EGO INC)	AUSTIN, TX	04/16/2021		
Nomadic Strand	Houston, TX	04/16/2021		
North Carolina	Raleigh, NC	04/16/2021		
North Houston Athletics	Magnolia, TX	04/16/2021	Submitted	05/04/2021 05/04/2021
North Star Screen Printing	Dallas, TX	04/16/2021		
NS BRANDING LLC	houston, TX	04/16/2021		

NT Printing Services	Houston, TX	04/16/2021			
NU HEIGHTS	Cypress, TX	04/16/2021			
Oak Hall Cap & Gown	Salem, VA	04/16/2021			
Oasis Apparel (Dioz Group)	North Hollywood, CA	04/16/2021			
OEM Supplies LLC	Irving, TX	04/16/2021			
OFFICE DEPOT	BOCA RATON, FL	04/16/2021			
OFFICE WORKS (KBC OFFICE WORKS, LLC)	Houston, TX	04/16/2021			
O'Hanlon, Demerath & Castillo	Austin, TX	04/16/2021			
Ohio State	Columbus, OH	04/16/2021			
One More Round Inc	Houston, TX	04/16/2021	No Bid	04/30/2021	04/30/2021
Online Stores, Inc	New Stanton, PA	04/16/2021			
Opal R. Helm, LLC	Houston, TX	04/16/2021			
Optimum Nurse Aid Skills Training	Houston, TX	04/16/2021			
Oregon	Salem, OR	04/16/2021			
Oriental Trading Company, Inc	Omaha, NE	04/16/2021			
Original Impressions	Houston, TX	04/16/2021			
ORR TEXTILE COMPANY	HOUSTON, TX	04/16/2021			
Ottomatic Threads	Cross Roads, TX		Viewed	05/18/2021	
Pacific Coast Flag	Sacramento, CA	04/16/2021			
Paddle Tramps Mfg. Co./AwardPlace	Lubbock, TX	04/16/2021			
Page International Communications	Houston, TX	04/16/2021			
Palos Sports, Inc	Alsip, IL	04/16/2021			
PARADISE AIR (Luck & Logic Inc.)	Kemah, TX	04/16/2021			
PAUL J. COSELLI, ATTORNEY AT LAW	BELLAIRE, TX	04/16/2021			
Paul P. Brice dba The Graphics Factory	Houston, TX	04/16/2021			
Pennsylvania	Harrisburg, PA	04/16/2021			
PepsiCo Foodservice	Spring, TX	04/16/2021			
Performing Arts Supply Co.	Houston, TX	04/16/2021			
PGA International, Inc. (Chris Gentile)	Houston, TX	04/16/2021			
Pheido Advertising	Houston, TX	04/16/2021			
PhotoBallGuy.com (Saf Enterprises LLC)	Las Vegas, NV	04/16/2021			
Photographs by Jim / Eagle Ford Signs	Floresville, TX	04/16/2021			
Pixels Custom Printng	katy, TX	04/16/2021			
Popular Embroidery Designs	Pasadena, TX	04/16/2021			
Positive Promotions	Hauppauge, NY	04/16/2021	Unsubmitted	05/11/2021	
Post Oak Graphics (Gulf Interstate Engineering dba Post Oak Graphics)	Houston, TX	04/16/2021			
Postal Products Unlimited (International Commerce & Marketing Inc.)	Milwaukee, WI	04/16/2021			
PREMIER & COMPANIES	NEW YORK, NY	04/16/2021			
Premier Heritage 105	Cypress, TX	04/16/2021			
Preschool Express Learning Academy	Humble, TX	04/16/2021			
Presidential Staffing Solutions	San Antonio, TX	04/16/2021			
Prestigious Sports Outfitters (Rogers)	McKinney, TX	04/16/2021			
Prevention & Treatment Resource Press (Education Specialty Publishing, LLC)	Metairie, LA	04/16/2021			
Prime Central Store (Waretrack, Inc.)	HOUSTON, TX	04/16/2021			
Prime Sanitizing	Mckinney, TX	04/16/2021			
Principle Information Technology	Houston, TX	04/16/2021			
Print Package Postal (Incept LLC)	Magnolia, TX	04/16/2021			
Printed Promotionals	corpus christi, TX	04/16/2021			
Printing Communications	Houston, TX	04/16/2021			
Printworks (Printworks LLC)	Beaverton, OR	04/16/2021			
PriorityHealthSupplies.com	hawthorne, NY	04/16/2021			
Pro Player Sports	Everett, WA	04/16/2021			
Productive Ventures	Spring, TX	04/16/2021			
Proforma Angelini & Associates (Angelini & Associates LLC)	Houston, TX	04/16/2021			
Proforma Image Marketing	Cleveland, OH	04/16/2021			
Proforma Media & Print Solutions (Martin Media & Print Solutions, LLC)	New Bruanfels, TX	04/16/2021			
Proforma MVP Marketing	Katy, TX	04/16/2021			
PROGRESSIVE PRODUCTS INC	PITTSBURG, KS	04/16/2021			
Project:Promotions	Missouri City, TX	04/16/2021			
Proline Supply Company	Houston, TX	04/16/2021			
Promo Entertainment Group	Grayson, GA	04/16/2021	Unsubmitted	05/18/2021	
Promo Solutions	Frisco, TX	04/16/2021	Unsubmitted	05/18/2021	



Promos On-Time	New York, NY	04/16/2021			
Promotion and Beyond Inc.	FOUNTAIN VALLEY, CA	04/16/2021			
PROMOTIONAL DESIGNS INC.	Green Bay, WI	04/16/2021			
ProSport Logistics	Springdale, AR	04/16/2021			
Pro-Tuff Decals	Crystal Lake, IL	04/16/2021			
Providence Office Products LLC	Conroe, TX	04/16/2021			
PuckettPro (PuckettPro Inc)	TX, TX	04/16/2021			
Purple Pear Promotional Products	Sugar Land, TX	04/16/2021			
Push Productions (Push Design Firm, LLC)	Tomball, TX	04/16/2021			
PYRAMID SCHOOL PRODUCTS (PYRAMID PAPER COMPANY)	TAMPA, FL	04/16/2021			
Quick Prints Inc	Central Islip, NY	04/16/2021			
QUILL CORPORATION	LINCOLNSHIRE, IL	04/16/2021			
Quinn Flags	Hanover, PA	04/16/2021			
Quintero Enterprises (Zoom Technologies LLC)	Ridgewood, NY	04/16/2021			
R & K Apparel (R & K Imports, Inc.)	Baldwin Park, CA	04/16/2021			
R Jones Events	Spring, TX	04/16/2021			
R&H Supply Inc (MEP R&H Inc)	Broussard, LA	04/16/2021			
R&R Material Supply Co., Inc	Houston, TX	04/16/2021			
R3 ROBOTICS, LLC	WIMBERLEY, TX	04/16/2021			
Radius Design Works, LLC	Cincinnati, OH	04/16/2021			
Rain Ponchos Plus, LLC	Keller, TX	04/16/2021			
Ramos & Harrison	Corpus Christi, TX	04/16/2021			
Raye Limited Inc	Calabasas, CA	04/16/2021			
Rebel Athletic Inc.	Carrollton, TX	04/16/2021			
Recreation Equipment Company	Spring Branch, TX	04/16/2021			
Red Cloud LLC	LOS ANGELES, CA		Viewed	05/13/2021	
Redline Print LLC	Kemah, TX	04/16/2021			
REDSMITH GRAPHIC SOLUTIONS	San Antonio, TX	04/16/2021			
Refrigeration Gaskets of Texas	Houston, TX	04/16/2021			
Refrigeration Technologies, LLC	Pottstown, PA		No Bid	05/06/2021	05/06/2021
Regency Office Products	Raleigh, NC	04/16/2021			
Re-Gifting Memories, LLC	Tomball, TX	04/16/2021			
Reliable R&R Training Services	Dallas, TX	04/16/2021			
Reliant Business Products, Inc.	Houston, TX	04/16/2021			
Results Advertising	Lebanon, MO	04/16/2021			
Reveal Medical (Simply Sophisticate)	Grand Prairie, TX	04/16/2021			
RGV Vocational Service,LLC	Mission, TX	04/16/2021			
Rhode Island	Providence, RI	04/16/2021			
Ricochet Promo	Houston, TX	04/16/2021			
RIDDELL	North Ridgeville, OH	04/16/2021	Submitted	05/18/2021	05/18/2021
Rio Paper & Supply LLC	Pharr, TX	04/16/2021			
Rising Star Academy	Houston, TX	04/16/2021			
RKD Enterprise	Humble, TX	04/16/2021			
Roberts & Ryan Investments, Inc.	New York, NY	04/16/2021			
Roberts Infinite Services LLC	Houston, TX	04/16/2021			
Rose Costumes	Denton, TX	04/16/2021			
Royalty by DeZign LLC	El Mirage, AZ	04/16/2021			
Rubber Stamps and More	Houston, TX	04/16/2021			
Rukaz Kultura	HOUSTON, TX	04/16/2021			
S Corporation	Phila, PA	04/16/2021			
S&H Uniforms	White Plains, NY	04/16/2021			
Safeguard (Texas Premier Safeguard, Inc)	Houston, TX	04/16/2021			
Safety Supply Inc	SAN ANTONIO, TX	04/16/2021			
Sage West Office Supplies (Ott Chin)	Houston, TX	04/16/2021			
Saifee Signs and Graphics	Houston, TX	04/16/2021			
Sala Printing Service (Thomas Wesley Sala)	Dallas, TX	04/16/2021			
San Antonio Lighthouse for the Blind	San Antonio, TX	04/16/2021			
Santex	dallas, TX	04/16/2021			
Scarborough Specialties, Inc	Lubbock, TX	04/16/2021	Viewed	05/13/2021	
Scardino Printing 1929, LLC	Spring, TX	04/16/2021			
Scholastic and Sports Recognition	Spring, TX	04/16/2021			
SCHOOL DISTRICT EXCHANGE	BEASLEY, TX	04/16/2021			
School Food Service Innovations	Jourdanton, TX	04/16/2021			
School Specialty	Greenville, WI	04/16/2021	No Bid	04/19/2021	04/19/2021
School Tee Factory (Custom Sportswear, Inc.)	Sewell, NJ	04/16/2021			
Schoolhouse Outfitters (School Outfitters)	Cincinnati, OH	04/16/2021			

SCHOOLLOCKER TEACHER SUPPLY	DEL RIO, TX	04/16/2021		
Schulenburg Printing and Office Supplies, Inc.	Schulenburg, TX	04/16/2021		
Science of Sport	Tucson, AZ	04/16/2021		
SCORE (American Soccer Co., Inc.)	Wilmington, CA	04/16/2021		
SCORE SPORTS (American Soccer Company, Inc.)	Wilmington, CA	04/16/2021		
Scoreboard Sports, LLC	Bountiful, UT	04/16/2021		
SEFNAK TRADING INC.	Sugar Land, TX	04/16/2021		
Sensei's School of Martial Arts	Houston, TX	04/16/2021		
Sequoia Safety Suppliers, LLC	Katy, TX		Viewed	05/11/2021
ServiceMaster Recovery Management (Service Environments of Texas, Inc.)	Kingwood, TX	04/16/2021		
Session Tax Consulting & Grant Writing (Session Tax Consulting and grant writing)	HOUSTON, TX	04/16/2021		
Set U Free Enterprises	houston, TX	04/16/2021		
Shadetree Mechanical Contractors	PHOENIX, AZ	04/16/2021		
SHC Sports (SHC Holdings LLC)	Cottonwood Falls, KS	04/16/2021		
Sherra Branch	Houston, TX	04/16/2021		
Shiffler Equipment Sales, Inc.	Chardon, OH	04/16/2021		
Shirts Caps And More (CCR Promotions, Inc.)	Hempstead, TX	04/16/2021		
Sign Authority Inc.	Garland, TX	04/16/2021		
Sign Champ Inc	SPRING, TX	04/16/2021		
Sign Pro	Bryan, TX	04/16/2021		
SIGN SOLUTIONS, INC	TOMBALL, TX	04/16/2021		
Signarama Global (HWI Capital)	San Antonio, TX	04/16/2021		
Signarama H-Town (JNB, LLC)	Houston, TX	04/16/2021		
Signature Aspen Imaging LLC	Houston, TX	04/16/2021		
Signature Media	Houston, TX	04/16/2021		
SIGNS BY TOMMORROW (Joco Ventures II)	Houston, TX	04/16/2021		
Signs of Success	Houston, TX	04/16/2021		
Sigtex Outdoor, Inc.	Tomball, TX	04/16/2021		
Sixcess Apparel	League City, TX	04/16/2021		
Skyline Book Binding Machines & GBC Supplies (Skyline Communications)	Santa Rosa, CA	04/16/2021		
Skyline Displays of Houston (Sabre Technologies, LP)	Houston, TX	04/16/2021		
Smart Scholars Foundation	Houston, TX	04/16/2021		
SMARTOX	Irving, TX	04/16/2021		
SmarTTurns, Inc. dba BookSmart Publishing	Winter Park, FL	04/16/2021		
SMC Promotions (Star MarCom Solutions, LLC)	Houston, TX	04/16/2021		
SmileMakers	Spartanburg, SC	04/16/2021		
SMR PROMOTIONS (GLOBAL MARKETING SOLUTIONS)	HURST, TX	04/16/2021		
Soccer 4 All	Missouri City, TX	04/16/2021		
Something New Dance	Fulshear, TX	04/16/2021		
South Carolina	Columbia, SC	04/16/2021		
South Coast Printing Inc	Houston, TX	04/16/2021		
SOUTH TEXAS PUMP INC	WESLACO, TX	04/16/2021		
Southeast Media, Inc.	Houston, TX	04/16/2021		
Southwest Precision Printers (Southwest Precision Printers & Associates LP)	Houston, TX	04/16/2021		
Southwest School & Office Supply (S.W. School Supply Inc)	Ontario, CA	04/16/2021		
SP Design & Manufacturer	Cape Coral, FL	04/16/2021		
Space City T-Shirts Etc. (Paul Downes)	Houston, TX	04/16/2021		
SPARKLE-dance	Mesquite, TX	04/16/2021		
Speedpro Imaging (Terramont Partners, Inc.)	The Woodlands, TX	04/16/2021		
Spirit Monkey, LLC	San Antonio, TX	04/16/2021		
Sportdecals, Inc	Spring Grove, IL	04/16/2021		
Sports Venue Padding (Artistic Coverings Inc)	Cerritos, CA	04/16/2021		
Sporturf	Dalton, GA	04/16/2021		
Spur Employment, Inc.	HUNTSVILLE, AL	04/16/2021		
SS GRAPHICS	Cypress, TX	04/16/2021		
SSR JACKETS (CUSTOM CHENILLE EMBROIDERY, INC.)	DALLAS, TX	04/16/2021	No Bid	04/16/2021 04/22/2021
St. George Sign Company	Houston, TX	04/16/2021		
STAR POLY BAG INC	brooklyn, NY	04/16/2021		

Steam Kidstute (Insight Community Resources Inc)	Houston, TX	04/16/2021			
Sterling Empowerment Stiff LLC	HOUSTON, TX	04/16/2021			
StockWise Solutions	Houston, TX	04/16/2021			
StoreSMART (Visual Horizons Inc)	Rochester, NY	04/16/2021			
Straight Defined	Copperas Cove, TX	04/16/2021			
Strategic Partnerships, Inc.	Austin, TX	04/16/2021			
STRAUS SYSTEMS INC	STAFFORD, TX	04/16/2021			
Strong Tower Trophies T Shirts and More (Graphic Results)	Magnolia, TX	04/16/2021			
StrongTree Products	Washougal, WA	04/16/2021			
STS Brand (STS Brand LLC)	Houston, TX	04/16/2021			
Studica Inc.	Sanborn, NY	04/16/2021			
Successful Starters Learning Academy II	Houston, TX	04/16/2021			
SUN AIRED BAG (QMS - SUN AIRED BAG)	Redondo Beach, CA	04/16/2021			
Superior Text	Ypsilanti, MI	04/16/2021			
SuperViewVision (Advance Century Inc)	City of Industry, CA	04/16/2021			
Suplay Products	Elma, WA	04/16/2021			
Suppliaholics	Phoenix, AZ	04/16/2021			
Supreme Fixture Company, Inc.	Little Rock, AR	04/16/2021			
Symonds Flags & Poles, Inc.	Fort Worth, TX	04/16/2021			
Syntheticcomp Companies	Sugar Land, TX	04/16/2021			
T9 Sports	Los Fresnos, TX	04/16/2021			
Teacher Created Resources	Westminster, CA	04/16/2021			
Teacher Direct (TDSA, LLC)	Birmingham, AL	04/16/2021			
Teachers Discovery Inc. (American Eagle Company Inc.)	Auburn Hills, MI	04/16/2021	No Bid	04/22/2021	04/22/2021
Team Express (Concourse Team Express LLC)	San Antonio, TX	04/16/2021			
Team Go Figure, LLP (Single Piece Apparel)	Mesquite, TX	04/16/2021	No Bid	05/18/2021	05/18/2021
Team Logo Inc	Fort Worth, TX	04/16/2021			
TeamLeader, Inc.	Plano, TX	04/16/2021			
TEC Sports	College Station, TX	04/16/2021			
Technology International, Inc.	Lake Mary, FL	04/16/2021			
TeeRex Embroidery	Cypress, TX	04/16/2021			
Tegeler Sports	Brenham, TX	04/16/2021			
Tejas Office Products, Inc.	Houston, TX	04/16/2021			
Texas	Austin, TX	04/16/2021			
Texas 4-H Youth Foundation	College Station, TX	04/16/2021			
Texas Association of African American Chambers of Commerce (TAAACC)	Austin, TX	04/16/2021			
Texas Covers (Creative Menus&Folders LLC)	Olden, TX	04/16/2021			
Texas Graphic Productions	Hockley, TX	04/16/2021			
Texas Motion Sports LLC	Richardson, TX	04/16/2021			
Texas Music Festivals Enterprise, Inc	San Juan, TX	04/16/2021	Submitted	04/28/2021	04/28/2021
Texas Promowear (Stitch Stores, Inc)	Humble, TX	04/16/2021	No Bid	05/11/2021	05/11/2021
THE BANDMANS COMPANY	FARMERS BRANCH, TX	04/16/2021			
The Baptiste Group LLC	Locust Grove, GA	04/16/2021			
The Class Ring Company	McAllen, TX	04/16/2021			
THE COLLINS GROUP	MARION, IN	04/16/2021			
The Costume Closet	Sherman, TX	04/16/2021	No Bid	05/11/2021	05/11/2021
The Document Group, Inc.	Houston, TX	04/16/2021			
The Donatto Group	Houston, TX	04/16/2021			
The Flag Store (J. Hugh Campbell Co., The Flag Store)	DALLAS, TX	04/16/2021			
The Gateway Group	Scottsdale, AZ	04/16/2021			
The Heart of God Restoration Ministry	Houston, TX	04/16/2021			
The Idea Source, inc	Katy, TX	04/16/2021			
The IRIS Companies (IRIS Ltd. Inc.)	Fleetwood, PA	04/16/2021			
The J Paul Company	Lewisville, TX	04/16/2021			
The MarketinGroup, LLC	Kingwood, TX	04/16/2021			
The Master Teacher	Manhattan, KS	04/16/2021			
The MLLES Alumnae, Inc.	Humble, TX	04/16/2021			
The Moret Group	New York, NY	04/16/2021			
The Motivation Recognition Group LLC	Richmond, TX	04/16/2021			
The National Behavioral Intervention Team Association	King of Prussia, PA	04/16/2021			

The Neff Company (Neff Motivation, Inc)	Greenville, OH	04/16/2021		
The Ombudsmen Group	Cibolo, TX	04/16/2021		
The Phlebotomy Learning Center	Houton, TX	04/16/2021		
The Phoenix Group (Phoenix Contracting Group)	Houston, TX	04/16/2021		
The Really Cool T-shirt Co.	Manchaca, TX	04/16/2021		
The Schoolhouse Store (The Schoolhouse Store Inc)	Conroe, TX	04/16/2021		
The Sign Depot (Lozz Quatezz LLC)	PHARR, TX	04/16/2021		
The Thomas Jarrms Company llc	Houston, TX	04/16/2021		
The Trade Group	Carrollton, TX	04/16/2021		
The Uniform Superstore, Inc.	Houston, TX	04/16/2021		
The Urban Circle (The Urban Circle LLC)	houston, TX	04/16/2021		
TheFireStore, TheOfficerStore, TheEMSStore (Witmer Public Safety Group, Inc)	Coatesville, PA	04/16/2021		
Thomas Printworks (Thomas Reprographics, Inc)	Houston, TX	04/16/2021		
Three Tikes LLC	Olympia, WA	04/16/2021		
Time Solutions Inc.	Baton Rouge, LA	04/16/2021		
Timothy Project: Youth Mentoring Youth, Inc.	Houston, TX	04/16/2021		
Tip Top Tuxedos (Al's Formal Wear)	Sioux City, IA	04/16/2021		
Tipton Global Sales & Services, Inc	Hurst, TX	04/16/2021		
Titan Signs and Graphics	Houston, TX	04/16/2021		
TMB Screen Printing	Houston, TX	04/16/2021		
TMB Screen Printing & Embroidery Spring	Spring, TX	04/16/2021		
TMB Screen Printing 2	Houston, TX	04/16/2021		
TMJ ENTERPRISES (Una Mae Dennison)	Houston, TX	04/16/2021		
TNR Accounting & Management Consulting, LLC (Nannette Ray)	Katy, TX	04/16/2021		
TNT Shirts	Houston, TX	04/16/2021		
TODAYS PROMOS	New Braunfels, TX	04/16/2021		
Today's Promotions (Today's Promos, LLC)	New Braunfels, TX	04/16/2021		
Total Graphic Designs	New Caney, TX	04/16/2021		
Trademarks Promotional Products	Houston, TX	04/16/2021	Viewed	05/11/2021
Trading Club International, Inc.	Houston, TX	04/16/2021		
Trainers Warehouse (Offic Images, Inc)	Natick, MA	04/16/2021		
Transcare llc	Houston, TX	04/16/2021		
Translatation & Interpretation Network (Catholic Charities Diocese of Fort Worth, Inc. d/b/a Translatation & Interpretation Network)	Fort Worth, TX	04/16/2021		
Trezvant Academy, Inc	Houston, TX	04/16/2021		
Triangle Reproductions	Houston, TX	04/16/2021		
Trinity Enterprise Group LLC	Dallas, TX	04/16/2021	Submitted	05/17/2021 05/17/2021
Triple D Uniform, Inc	Houston, TX	04/16/2021		
Trophy House LLC (Ash Seawright (sole proprietor))	Conroe, TX	04/16/2021		
T-Shirts Etc. West Houston (Clutch City Services, Limited Liability Company)	Houston, TX	04/16/2021		
T-Shirts Ink	The Woodlands, TX	04/16/2021		
Turner Sign Systems	Richland Hills, TX	04/16/2021		
Two Guys Laser Engraving	Terrell, TX	04/16/2021		
XTREME PROMOTIONS	HUMBLE, TX	04/16/2021		
U. S. WHOLESALE PRODUCTS	SAN ANTONIO, TX	04/16/2021		
U.S Electronics recycling Center Inc (Isaac F Sunday)	Houston, TX	04/16/2021		
U.S. Flag and Flagpole Supply, LP	Beaumont, TX	04/16/2021		
Ultra Print LLC	Texas, TX	04/16/2021		
Ulysses S Dotson & Assoc.,Inc	Houston, TX	04/16/2021		
UNBEATABLE SALE INC	LAKEWOOD, NJ	04/16/2021		
UniFirst Corporation	Corpus Christi, TX	04/16/2021		
UNIFORM WORLD INC	Dallas, TX	04/16/2021		
UNIFORMS INCORPORATED	DALLAS, TX	04/16/2021		
Uniforms Manufacturing, Inc	Scottsdale, AZ	04/16/2021		
Unity Education Resources (MyOfficeProducts, LLC)	Nashville, TN	04/16/2021		
Unlimited Print (Mayer Enterprises)	Houston, TX	04/16/2021		
UPKEEP PRESERVATION SERVICES LLC (MARIN)	HOUSTON, TX	04/16/2021		
US Executive LLC	Tampa, FL	04/16/2021		

USG Staffing LLC	Humble, TX	04/16/2021		
USI Education and Government Sales (New Precision Technology, LLC)	Madison, CT	04/16/2021		
Utturn Concepts Inc	Houston, TX	04/16/2021		
V R Promotions LLC	Fort Worth, TX	04/16/2021		
Valley Trophies, LLC	Weslaco, TX	04/16/2021		
Varsity Brands Holding Co., Inc. (Varsity Spirit Fashions)	Memphis, TN	04/16/2021		
Varsity Impact (Varsity Brands Holding Co., Inc.)	Memphis, TN	04/16/2021		
Varsity Spirit Fashion	Memphis, TN	04/16/2021		
VCI Group Inc.	Houston, TX	04/16/2021		
VECOPRESS (AUTOMEDLAND)	Houston, TX	04/16/2021		
Vestige International	Desoto, TX	04/16/2021		
Virginia	Richmond, VA	04/16/2021		
Visiontron Corp.	Hauppauge, NY	04/16/2021		
VS Athletics	San Luis Obispo, CA	04/16/2021		
VSA, Inc	Lincoln, NE	04/16/2021		
Walk the Walk Promotions	Richardson, TX	04/16/2021		
Walker's Empire Services	houston, TX	04/16/2021		
Walls Printing (KPW Enterprises)	Dallas, TX	04/16/2021		
Washington	Olympia, WA	04/16/2021		
Waterbottles.com (Wb Promos, LLC)	Covina, CA	04/16/2021		
WAYNE ENTERPRISES, INC. (WAYNE D. ENTERPRISES, INC.)	HOUSTON, TX	04/16/2021		
We Brand It Promotions	Hempstead, TX	04/16/2021	Viewed	05/11/2021
Wendy Perry Coparenting Education (www.wendyjerry.com)	Watauga, TX	04/16/2021		
West Road Teacher Supply (Distribuidora Alfa y Omega Inc.)	Houston, TX	04/16/2021		
West Virginia	Charleston, WV	04/16/2021		
Western Lithograph	Houston, TX	04/16/2021		
Whitener Enterprises, Inc	Conroe, TX	04/16/2021		
Wisconsin	Madison, WI	04/16/2021		
Wood Alternator and Starter Service (Homer J. Wood)	Houston, TX	04/16/2021		
Woodlands Trophies & Awards	Conroe, TX	04/16/2021		
World Of Promotions	ELK Grove Village, IL	04/16/2021		
worldwide specialty advertising	Ft Worth, TX	04/16/2021		
www.signarama-katyfulshear.com	Katy, TX	04/16/2021		
www.spiritsupply.com	Grand Prairie, TX	04/16/2021		
Wylie Construction Services	Humble, TX		No Bid	05/07/2021 05/07/2021
xtremetees embroidery and printing	San Juan, TX	04/16/2021		
Xyles LLC	Round Rock, TX	04/16/2021		
Youtopian Uniforms	Jacksonville, FL	04/16/2021		
Zion Redemption	Houston, TX	04/16/2021		
Z-Man Direct Inc.	Humble, TX	04/16/2021		
ZNA DESIGN (ZNA GROUP LLC)	Katy, TX	04/16/2021		
Zone Swimwear (Zone International)	McLean, VA	04/16/2021		

---

## External Invitations

---

### Participant Detail

#### 2 Inspire Peace

Address 1808 S. Good Latimer Expressway Participation Type: Active Supplier  
Dallas, TX 75226

Classifications MBE (Primary),SBE,WBE

Invitation Date 04/16/2021

Invitation Type Automatic

Invitation Email(s) 2inspirepeace@gmail.com

23 THRU ME LLC (23 THRU ME)

Address PO Box 91547  
Houston, TX 77291 Participation Type: Active Supplier

Classifications MBE (Primary),SBE,WBE

Invitation Date 04/16/2021  
Invitation Type Automatic  
Invitation Email(s) laquedadavis@gmail.com

2nd Nature Design Studio (Donavin Murray)

Address 5818 Beeston Ln  
Houston, TX 77084 Participation Type: Active Supplier

Classifications MBE,SBE (Primary)

Invitation Date 04/16/2021  
Invitation Type Automatic  
Invitation Email(s) info@2ndnaturedesignstudio.com

2Tier Wholesalers

Address 6022 Jester Drive  
Garland, TX 75044 Participation Type: Active Supplier

Classifications MBE,SBE,HUB (Primary),WBE

Invitation Date 04/16/2021  
Invitation Type Automatic  
Invitation Email(s) donnie@2tierwholesaleinc.com

3 Crafty Sisters

Address 605 Tracy Street  
Greenville, TX 75402 Participation Type: Active Supplier

Classifications SBE (Primary),WBE

Invitation Date 04/16/2021  
Invitation Type Automatic  
Invitation Email(s) valerie@3craftysisters.com

3 Oaks Resource Group International (Your School Resource Group, Inc.)

Address PO BOX 565492  
PINECREST, FL 33256 Participation Type: Active Supplier

Invitation Date 04/16/2021  
Invitation Type Automatic  
Invitation Email(s) molkes@3oaksgroup.com

365 Paving & Construction LLC

Address 1618 E. Griffin Parkway  
Mission, TX 78572 Participation Type: Active Supplier

Invitation Date 04/16/2021  
Invitation Type Automatic  
Invitation Email(s) 365paving@gmail.com

4imprint, Inc.

Address 101 Commerce St  
Oshkosh, WI 54901 Participation Type: Active Supplier

Invitation Date 04/16/2021  
Invitation Type Automatic  
Invitation Email(s) bids@4imprint.com  
Response Date 05/12/2021  
Response Status Submitted  
Status Date 05/12/2021

5W Public Relations

Address 230 Park Ave  
New York, NY 10169 Participation Type: Active Supplier

Invitation Date 04/16/2021  
Invitation Type Automatic  
Invitation Email(s) assistant@5wpr.com

A Plus Career Apparel

Address 5923 Cardinal Creek Way  
Kingwood, TX 77345 Participation Type: Active Supplier

Invitation Date 04/16/2021  
Invitation Type Automatic  
Invitation Email(s)

A Plus Trophy (Carl B Andrews dba A Plus Trophy)

Address 1010 1st Street E  
Humble, TX 77338 Participation Type: Active Supplier

Invitation Date 04/16/2021  
Invitation Type Automatic  
Invitation Email(s) aplustrophyllc@aol.com aplustrophy@aol.com

A Sign of Quality

Address 5707 STATE HIGHWAY 276  
ROYSE CITY, TX 75189 Participation Type: Active Supplier

Invitation Date 04/16/2021  
Invitation Type Automatic  
Invitation Email(s) nick@asoq.com

A&M Executive Services LLC

Address 280 Merchants Drive  
Dallas, GA 30132 Participation Type: Active Supplier

Classifications MBE (Primary),SBE,WBE

Invitation Date 04/16/2021  
Invitation Type Automatic  
Invitation Email(s)

A+ Literacy Education And Development

Address 2415 S. Dairy Ashford C11  
Houston, TX 77077 Participation Type: Active Supplier

Classifications MBE,SBE (Primary),WBE

Invitation Date 04/16/2021  
Invitation Type Automatic  
Invitation Email(s) office@LiteracyEdServices.com

A1 SPORTS CENTER

Address 1027 BANDERA ROAD  
SAN ANTONIO, TX 78245 Participation Type: Active Supplier

Invitation Date 04/16/2021  
Invitation Type Automatic  
Invitation Email(s) asarfati@a1sportstx.com

AAA Painting

Address 6005 Westview Rd.  
Houston, TX 77055 Participation Type: Active Supplier

Invitation Date 04/16/2021  
Invitation Type Automatic  
Invitation Email(s)

ABC Promos & Gifts

Address 540 1st Street West  
Milan, IL 61264 Participation Type: Active Supplier

Classifications SBE (Primary),WBE

Invitation Date 04/16/2021  
Invitation Type Automatic  
Invitation Email(s)

Absolute Color Mailplex

Address 11101 Ella Blvd  
Houston, TX 77067 Participation Type: Active Supplier

Classifications MBE (Primary),SBE,HUB,WBE

Invitation Date 04/16/2021  
Invitation Type Automatic  
Invitation Email(s) christy@acmailplex.com

AC PRINTING, LLC

Address 3400-1 SOUTH RAIDER DRIVE  
EULESS, TX 76040 Participation Type: Active Supplier

Classifications MBE,SBE (Primary),HUB

Invitation Date 04/16/2021  
Invitation Type Automatic  
Invitation Email(s) DEBBIE@ACPRINTING.COM

Accel Lifestyle, LLC.

Address 1210 W Clay St. #23  
Houston, TX 77019 Participation Type: Active Supplier

Classifications SBE,HUB (Primary),WBE

Invitation Date 04/16/2021  
Invitation Type Automatic  
Invitation Email(s) chris@accellifestyle.com

Ace Promotions

Address 335 Lozano Lane  
San Benito, TX 78586 Participation Type: Active Supplier

Invitation Date 04/16/2021  
Invitation Type Automatic  
Invitation Email(s) acepromo\_pat@yahoo.com  
Response Status Viewed  
Status Date 05/17/2021

Ace T-Shirts

Address 2120 CATALINA DR  
Pasadena, TX 77503 Participation Type: Active Supplier

Classifications SBE (Primary)

Invitation Date 04/16/2021  
Invitation Type Automatic  
Invitation Email(s) sales@acetshirts.com

Action Screen Graphics

Address 1406 Smith Road, Suite F  
Austin, TX 78721 Participation Type: Active Supplier

Invitation Date 04/16/2021  
Invitation Type Automatic  
Invitation Email(s) emilyschex@gmail.com



Addikshun Athletic Apparel (Dream Big Think Smart Marketing)

Address 2450 Louisiana St. Participation Type: Active Supplier  
Houston, TX 77006

Classifications MBE,SBE (Primary)

Invitation Date 04/16/2021  
Invitation Type Automatic  
Invitation Email(s) sales@addikshunathletiks.com

Adele's Coaching and Consulting

Address 6654 Laughlin Dr. Participation Type: Active Supplier  
Missouri City, TX 77489

Classifications MBE,WBE (Primary)

Invitation Date 04/16/2021  
Invitation Type Automatic  
Invitation Email(s) kbeaty72@gmail.com

ADPOWER

Address 6060 South Loop East # 110 Participation Type: Active Supplier  
Houston, TX 77033

Invitation Date 04/16/2021  
Invitation Type Automatic  
Invitation Email(s)

ADS Custom Signs, Inc.

Address 1315 Fresa Rd Participation Type: Active Supplier  
Pasadena, TX 77502

Classifications MBE,WBE (Primary)

Invitation Date 04/16/2021  
Invitation Type Automatic  
Invitation Email(s) estimator@ads-signs.com

Advanced Graphics (MBR, Inc.)

Address P.O. Box 2001 Participation Type: Active Supplier  
Katy, TX 77492

Classifications SBE (Primary)

Invitation Date 04/16/2021  
Invitation Type Automatic  
Invitation Email(s) sonya@myadvancedgraphics.com

Advantage Business Products

Address 15280 South Springwater Road Participation Type: Active Supplier  
Oregon City, OR 97045

Classifications WBE (Primary)

Invitation Date 04/16/2021  
Invitation Type Automatic  
Invitation Email(s) jimadvantage@yahoo.com

Advantage office products

Address 5722 Bingle Suite B Participation Type: Active Supplier  
Houston, TX 77092

Classifications MBE (Primary)

Invitation Date 04/16/2021  
Invitation Type Automatic  
Invitation Email(s)

Advantage Supply

Address PO Box 471103  
Fort Worth, TX 76147 Participation Type: Active Supplier

Classifications MBE,TXM (Primary),USC,SBE,HUB,WBE

Invitation Date 04/16/2021  
Invitation Type Automatic  
Invitation Email(s) bids@advantagesupply.us

ADVENTURES IN LEARNING (Gregory Dale Laufer)

Address 7230 Gateway Blvd East  
El Paso, TX 79915 Participation Type: Active Supplier

Classifications TAS (Primary)

Invitation Date 04/16/2021  
Invitation Type Automatic  
Invitation Email(s) greg@ailtq.com

Ad-Wear and Specialty of Texas

Address 8120 Westglen Dr  
Houston, TX 77063 Participation Type: Active Supplier

Classifications MBE,SBE,HUB (Primary)

Invitation Date 04/16/2021  
Invitation Type Automatic  
Invitation Email(s) david@adweartex.com

AFFORDABLE SIGNS

Address 3645 Violet St  
HUNTSVILLE, TX 77340 Participation Type: Active Supplier

Classifications WBE (Primary)

Invitation Date 04/16/2021  
Invitation Type Automatic  
Invitation Email(s) affordablesignstx@gmail.com

AFP INDUSTRIES, INC.

Address P.O. BOX 43-0747  
SOUTH MIAMI, FL 33243-0747 Participation Type: Active Supplier

Classifications MBE,SBE (Primary),WBE

Invitation Date 04/16/2021  
Invitation Type Automatic  
Invitation Email(s) sales@afpschoolsupply.com

AGAS MFG

Address 2701 E. Tioga St.  
Philadelphia, PA 19134 Participation Type: Active Supplier

Classifications SBE (Primary)

Invitation Date 04/16/2021  
Invitation Type Automatic  
Invitation Email(s) shira@agasmfg.com  
Response Status Viewed  
Status Date 05/12/2021

AGH2O Holdings, LLC

Address 3817 Bent Brook Drive Round Rock, TX 78664 Participation Type: Active Supplier

Invitation Date 04/16/2021  
Invitation Type Automatic  
Invitation Email(s) jlesko@austin.rr.com

AHMS (Auto & Home Mobility Equipment)

Address 1902 Pinon Drive College Station, TX 77845 Participation Type: Active Supplier

Classifications MBE,SBE (Primary),HUB,WBE

Invitation Date 04/16/2021  
Invitation Type Automatic  
Invitation Email(s) shari@ahms.info

Aimgraphics (American Installation and Management, LLC)

Address 1407 woodridge circle Euless, TX 76040 Participation Type: Active Supplier

Invitation Date 04/16/2021  
Invitation Type Automatic  
Invitation Email(s) michelle@aimgraphicsco.com

AJL Advertising Specialties, Inc.

Address 2101 Airport Blvd, Suite 100 Austin, TX 78722 Participation Type: Active Supplier

Invitation Date 04/16/2021  
Invitation Type Automatic  
Invitation Email(s) andy@ajladvertising.com

Alabama

Address P.O. Box 5690 Montgomery, AL 36103 Participation Type: Active Supplier

Invitation Date 04/16/2021  
Invitation Type Manual  
Invitation Email(s)

Alegna Technologies, Inc.

Address 3700 Kennesaw S. Industrial Drive NW Kennesaw, GA 30144 Participation Type: Active Supplier

Classifications MBE (Primary),SBE,WBE

Invitation Date 04/16/2021  
Invitation Type Automatic  
Invitation Email(s) ACabrera@AlegnaTechnologies.com

Algy Costumes & Uniforms (Algy Trimmings Co Inc)

Address 440 NE First Ave Hallandale, FL 33009 Participation Type: Active Supplier

Classifications WBE (Primary)

Invitation Date 04/16/2021  
Invitation Type Automatic  
Invitation Email(s) customerservice@algyteam.com

All About Events

---

Address 7810 Chinon Circle  
Houston, TX 77071 Participation Type: Active Supplier

Classifications MBE,HUB (Primary)

Invitation Date 04/16/2021  
Invitation Type Automatic  
Invitation Email(s) elmer@allaevents.com

All Flag & Flagpoles, Inc.

---

Address 97 Gnarled Hollow Road  
East Setauket, NY 11733 Participation Type: Active Supplier

Classifications SBE (Primary),WBE

Invitation Date 04/16/2021  
Invitation Type Automatic  
Invitation Email(s) Lisa@All-Flags.com

All Printing (All Print & Office supply)

---

Address 11739 South Wilcrest Drive  
Houston, TX 77099 Participation Type: Active Supplier

Classifications MBE (Primary),HUB

Invitation Date 04/16/2021  
Invitation Type Automatic  
Invitation Email(s) info@all-printing.com

ALL VALLEY DRUG SCREENS

---

Address 7115 PADRE ISLAND HWY,suite A  
Brownsville, TX 78521 Participation Type: Active Supplier

Classifications WBE (Primary)

Invitation Date 04/16/2021  
Invitation Type Automatic  
Invitation Email(s) lpederson11@gmail.com

Alliance Loose Leaf (JPS Alliance, Inc.)

---

Address 4625 Martin St.  
Fort Worth, TX 76119 Participation Type: Active Supplier

Classifications SBE (Primary),WBE

Invitation Date 04/16/2021  
Invitation Type Automatic  
Invitation Email(s)

Alliance Strategic Business Services, LP

---

Address 6990 Portwest Drive  
Houston, TX 77024 Participation Type: Active Supplier

Classifications DIR (Primary)

Invitation Date 04/16/2021  
Invitation Type Automatic  
Invitation Email(s) susan.primm@alliancesbs.com

Allied Products Corporation

---

Address 1420 Kansas Avenue  
Kansas City, MO 64127 Participation Type: Active Supplier

Invitation Date 04/16/2021  
Invitation Type Automatic  
Invitation Email(s) terriw@alliedmaterials.com

Allied Signs

---

Address 6820 Harwin Dr. Participation Type: Active Supplier  
Houston, TX 77036

Invitation Date 04/16/2021  
Invitation Type Automatic  
Invitation Email(s) alliedsigns1@gmail.com

AllTex Welding Supply, Inc.

---

Address 30903 Washington Street Participation Type: Active Supplier  
Waller, TX 77484

Invitation Date 04/16/2021  
Invitation Type Automatic  
Invitation Email(s) justink@alltexpweld.com

Alphagraphics 600 (A Dog Solutions)

---

Address 9971 W. Interstate Hwy 10 Participation Type: Active Supplier  
San Antonio, TX 78230

Invitation Date 04/16/2021  
Invitation Type Automatic  
Invitation Email(s) susan@alphagraphics.com

Alphagraphics of Conroe (Shakun Solutions, LLC)

---

Address 3606 N. Frazier Participation Type: Active Supplier  
Conroe, TX 77303

Classifications WBE (Primary)

Invitation Date 04/16/2021  
Invitation Type Automatic  
Invitation Email(s) cs2@alphagraphics.com

Altius Graphics (NAYAK Corporation)

---

Address 11205 Main St., Ste 118 Participation Type: Active Supplier  
Houston, TX 77025

Classifications MBE (Primary),SBE,HUB

Invitation Date 04/16/2021  
Invitation Type Automatic  
Invitation Email(s) siddhartha.nayak@altiusgraphics.com

AMAZING AWARDS INC

---

Address 4622 FM 1960 RD W Participation Type: Active Supplier  
HOUSTON, TX 77069

Classifications MBE,SBE (Primary),HUB

Invitation Date 04/16/2021  
Invitation Type Automatic  
Invitation Email(s) info@azawards.com

AMC Promotional Products

---

Address 16255 TUDOR GROVE DR. Participation Type: Active Supplier  
ORLANDA, FL 32828

Classifications MBE,TAS,TPA,SBE (Primary)

Invitation Date 04/16/2021  
Invitation Type Automatic  
Invitation Email(s) david@amcpromotionalproducts.com  
Response Status Viewed  
Status Date 05/11/2021

America Team Sports

Address 904 Business Parkway Richardson, TX 75081 Participation Type: Active Supplier

Classifications SBE (Primary)

Invitation Date 04/16/2021  
Invitation Type Automatic  
Invitation Email(s) adam@americatamsports.com

AMERICA'S BEST FLAGS AND FLAGPOLES

Address 858 CAMEL BACK DRIVE NEW BRAUNFELS, TX 78130-2461 Participation Type: Active Supplier

Classifications SBE,WBE (Primary)

Invitation Date 04/16/2021  
Invitation Type Automatic  
Invitation Email(s) usa@myflag.com

American Aviation Services

Address 18227 Becker Road Hockley, TX 77447 Participation Type: Active Supplier

Invitation Date 04/16/2021  
Invitation Type Automatic  
Invitation Email(s) dean@americanaviationsvs.com

American Flag Pole

Address 26242 Hillman Highway Abingdon, VA 24210 Participation Type: Active Supplier

Invitation Date 04/16/2021  
Invitation Type Automatic  
Invitation Email(s) brad@hapco.com

American Hotel Register Company

Address 100 S Milwaukee Ave Vernon Hills, IL 60061 Participation Type: Active Supplier

Classifications TXM (Primary)

Invitation Date 04/16/2021  
Invitation Type Automatic  
Invitation Email(s)

American Medical Institute Inc (N/A)

Address 6902 Cook Road Houston, TX 77072 Participation Type: Active Supplier

Invitation Date 04/16/2021  
Invitation Type Automatic  
Invitation Email(s) lfye@msn.com

American Pride Paper and Plastic

Address 87 Arlington Ave Lakewood, NJ 08701 Participation Type: Active Supplier

Invitation Date 04/16/2021  
Invitation Type Automatic  
Invitation Email(s)

AMERICAN SCREEN GRAPHICS

Address 1701 NORTH PARK #33 KINGWOOD, TX 77339 Participation Type: Active Supplier

Classifications HUB (Primary)

Invitation Date 04/16/2021  
Invitation Type Automatic  
Invitation Email(s) JACKIET.ASG@HOTMAIL.COM

American Specialty Advertising and Promotional Marketing LLC

Address PO Box 1976 Allen, TX 75013 Participation Type: Active Supplier

Classifications SBE (Primary)

Invitation Date 04/16/2021  
Invitation Type Automatic  
Invitation Email(s) chris@americanspecialtyadvertising.com

Ameritex Flag and Flagpole LLC

Address 13414 Serenity Ln San Antonio, TX 78232 Participation Type: Active Supplier

Invitation Date 04/16/2021  
Invitation Type Automatic  
Invitation Email(s)

Anderson Hydra Platforms, Inc.

Address 7703 Park Place Rd York, SC 29745 Participation Type: Active Supplier

Invitation Date 04/16/2021  
Invitation Type Automatic  
Invitation Email(s) cyndi@inspectabridge.com

Andersons (Taymark)

Address PO Box 1151 Minneapolis, MN 55440-1151 Participation Type: Active Supplier

Invitation Date 04/16/2021  
Invitation Type Automatic  
Invitation Email(s) kmschneider@taylorcorp.com

Ann Marie Harbour

Address 11107 Dawson Springs Dr. Richmond, TX 77406 Participation Type: Active Supplier

Invitation Date 04/16/2021  
Invitation Type Automatic  
Invitation Email(s) annmariemobile@gmail.com

Anodizing Graphics of Texas (Durable Printed Products, Inc.)

Address 819 Success Ct Stafford, TX 77477 Participation Type: Active Supplier

Classifications SBE (Primary),WBE

Invitation Date 04/16/2021  
Invitation Type Automatic  
Invitation Email(s) agtfrontdesk@verizon.net

Apollo Office Systems LLC

Address 407 S 2nd Street Participation Type: Active Supplier  
Alvin, TX 77511

Classifications MBE,DIR,SBE,HUB,WBE

Invitation Date 04/16/2021  
Invitation Type Automatic  
Invitation Email(s) pfoley@apolloofficesystems.com

Aramark

Address 10501 Fischer Road Participation Type: Active Supplier  
Von Ormy, TX 78073

Invitation Date 04/16/2021  
Invitation Type Automatic  
Invitation Email(s) holly.harris@uniform.aramark.com

Aramark Management Services Limited Partnership (Aramark SMMS LLC)

Address 2400 Market Street Participation Type: Active Supplier  
Philadelphia, PA 19103

Invitation Date 04/16/2021  
Invitation Type Automatic  
Invitation Email(s) growth@aramark.com

Arctic Guard

Address 2122 Garden Terrace Participation Type: Active Supplier  
Katy, TX 77494

Classifications WBE (Primary)

Invitation Date 04/16/2021  
Invitation Type Automatic  
Invitation Email(s) jennifer@arcticguard.com

Armor Gear

Address 203 Unique Ct. Participation Type: Active Supplier  
Rosharon, TX 77583

Classifications MBE,SBE (Primary),WBE

Invitation Date 04/16/2021  
Invitation Type Automatic  
Invitation Email(s) sheoop@aol.com

ARRAY

Address 6703 Chimney Rock Participation Type: Active Supplier  
Bellaire, TX 77401

Invitation Date 04/16/2021  
Invitation Type Automatic  
Invitation Email(s) ram.vidaurri@trustarray.com  
Response Status Viewed  
Status Date 05/11/2021

Artex Neu LLC

Address 9056 Long Point Rd Participation Type: Active Supplier  
Housotn, TX 77055

Classifications MBE (Primary)

Invitation Date 04/16/2021  
Invitation Type Automatic  
Invitation Email(s) crystal.artexneu@att.net  
Response Status Unsubmitted  
Status Date 05/17/2021



Artistic Awards, Inc. (Mark Leinen)

---

Address 10870 Plano Road Participation Type: Active Supplier  
Dallas, TX 75238

Invitation Date 04/16/2021  
Invitation Type Automatic  
Invitation Email(s) sales@artistic-awards.com  
Response Status Viewed  
Status Date 05/17/2021

Ascend Performance Materials Operations LLC

---

Address 1010 Travis St., Ste. 900 Participation Type: Active Supplier  
Houston, TX 77002

Invitation Date 04/16/2021  
Invitation Type Automatic  
Invitation Email(s) vmarkh@ascendmaterials.com

Astro Apparel & Uniforms

---

Address 6019 Winsome Lane Participation Type: Active Supplier  
HOUSTON, TX 77057

Invitation Date 04/16/2021  
Invitation Type Automatic  
Invitation Email(s) info@aauniforms.net

Astrov & Associates

---

Address P.O. Box 1133 Participation Type: Active Supplier  
Frisco, TX 75034

Classifications MBE (Primary),SBE

Invitation Date 04/16/2021  
Invitation Type Automatic  
Invitation Email(s) smjuster@yahoo.com

Athletes World

---

Address 2040 W. Cuthbert Ave Participation Type: Active Supplier  
Midland, TX 79701

Classifications TAS,SBE (Primary)

Invitation Date 04/16/2021  
Invitation Type Automatic  
Invitation Email(s) jack@stadiumsportsusa.com

Atlantic Training

---

Address 101 North Broad Street Participation Type: Active Supplier  
Middletown, DE 19709

Invitation Date 04/16/2021  
Invitation Type Automatic  
Invitation Email(s) mcarey@atlantictraining.com

Atlas Embroidery LLC

---

Address 3544 Comal Springs Participation Type: Active Supplier  
Canyon Lake, TX 78133

Classifications SBE (Primary)

Invitation Date 04/16/2021  
Invitation Type Automatic  
Invitation Email(s) debbieortega@gvtc.com

Authentic Promotions.com

---

Address 6151 Fair Oaks Blvd. Participation Type: Active Supplier  
Carmichael, CA 95608-4894

Classifications SBE (Primary),WBE

Invitation Date 04/16/2021  
Invitation Type Automatic  
Invitation Email(s) peter@authenticpromotions.com amy@authenticpromotions.com  
Response Date 05/17/2021  
Response Status Submitted  
Status Date 05/17/2021

---

Aviva Wholesale (Nur International Inc)

Address 7000-A Harwin Drive Participation Type: Active Supplier  
Houston, TX 77036

Invitation Date 04/16/2021  
Invitation Type Automatic  
Invitation Email(s) info@AvivaWholesale.com

---

Award America

Address 7110 Louetta Suite H Participation Type: Active Supplier  
Spring, TX 77379

Classifications MBE,SBE (Primary)

Invitation Date 04/16/2021  
Invitation Type Automatic  
Invitation Email(s) awardamerica@msn.com

---

AWARDS & ENGRAVING

Address 1214 MASSEY TOMPKINS Participation Type: Active Supplier  
BAYTOWN, TX 77521

Invitation Date 04/16/2021  
Invitation Type Automatic  
Invitation Email(s) michelle.b@awards-engraving.com

---

Awards by Gulf Coast Trophies

Address 115 S Shaver Street Participation Type: Active Supplier  
Pasadena, TX 77506

Classifications SBE (Primary)

Invitation Date 04/16/2021  
Invitation Type Automatic  
Invitation Email(s) sales@gctawards.com  
Response Status Unsubmitted  
Status Date 05/11/2021

---

AWARDS OF DISTINCTION (AWARDS OF DISTINCTION, INC.)

Address 16623 SEALARK RD Participation Type: Active Supplier  
HOUSTON, TX 77062

Classifications SBE (Primary),HUB,WBE

Invitation Date 04/16/2021  
Invitation Type Automatic  
Invitation Email(s) marcia@awardsofdistinction.com

B Hidalgo Industries Inc

---

Address 2902 N Alexander DR Lot 18 Participation Type: Active Supplier  
Baytown, TX 77520

Classifications SBE (Primary)

Invitation Date 04/16/2021  
Invitation Type Automatic  
Invitation Email(s) bill.hidalgo@yahoo.com  
Response Date 05/17/2021  
Response Status Submitted  
Status Date 05/17/2021

---

Balance Sporting Goods

Address 2312 Highway 281 N. Participation Type: Active Supplier  
Marble Falls, TX 78654

Classifications HUB (Primary),WBE

Invitation Date 04/16/2021  
Invitation Type Automatic  
Invitation Email(s) rc\_mfac@yahoo.com

---

Balfour Company (Pride and Recognition)

Address 8525 Westland West Blvd. Participation Type: Active Supplier  
Houston, TX 77041

Invitation Date 04/16/2021  
Invitation Type Automatic  
Invitation Email(s) butchm@balfourhouston.com mattm@balfourhouston.com

---

Balfour Yearbooks (Campus Impressions USA)

Address 2930 Chimney Rock Participation Type: Active Supplier  
Houston, TX 77056

Classifications SBE (Primary)

Invitation Date 04/16/2021  
Invitation Type Automatic  
Invitation Email(s) Lisa.schwartz@balfour-rep.com  
Response Date 05/06/2021  
Response Status No Bid  
Status Date 04/16/2021

---

Barbara LaGatta Promotional Products Inc

Address 1104 Creek Cabin Participation Type: Active Supplier  
San Antonio, TX 78253

Classifications HUB,WBE (Primary)

Invitation Date 04/16/2021  
Invitation Type Automatic  
Invitation Email(s) barbara\_lagatta@msn.com

---

Barefoot (C&G Sporting Goods)

Address 189 Reta St Participation Type: Active Supplier  
Stephenville, TX 76401

Classifications TAS (Primary)

Invitation Date 04/16/2021  
Invitation Type Automatic  
Invitation Email(s) kdupre@barefootathletics.com

BASIC OFFICE AND SCHOOL SUPPLY (RELIABLE OFFICE PRODUCTS, INC.)

Address 10831 WOODEDGE DR. Participation Type: Active Supplier  
HOUSTON, TX 77070

Classifications MBE (Primary)

Invitation Date 04/16/2021  
Invitation Type Automatic  
Invitation Email(s) BASICSUPPLY@GMAIL.COM

Basil & Co. LLC

Address 11811 N Freeway Suite 500 Participation Type: Active Supplier  
Houston, TX 77060

Classifications MBE (Primary),WBE

Invitation Date 04/16/2021  
Invitation Type Automatic  
Invitation Email(s) figen@basilnco.com

BAY PROMO LLC

Address 6201 Johns Road, Suite 9 Participation Type: Active Supplier  
Tampa, FL 33634

Classifications SBE (Primary)

Response Date 05/18/2021  
Response Status Submitted  
Status Date 05/18/2021

BBeauti AndLashes LLC

Address 2200 N Sam Houston PKWY E Participation Type: Active Supplier  
Houston, TX 77032

Classifications MBE (Primary),SBE,WBE

Invitation Date 04/16/2021  
Invitation Type Automatic  
Invitation Email(s) barnes.breshay@gmail.com

BDK And Associates LLC

Address 210 Cheek Sparger Rd Participation Type: Active Supplier  
Colleyville, TX 76034

Invitation Date 04/16/2021  
Invitation Type Automatic  
Invitation Email(s)

Be Sparkle (BSPARKLE LLC)

Address 9205 Eagle Dr Ste 300 # 188 Participation Type: Active Supplier  
Baytown, TX 77523

Classifications SBE (Primary),WBE

Invitation Date 04/16/2021  
Invitation Type Automatic  
Invitation Email(s) support@besparklefashion.com

BE Staffing Solutions LLC

Address 507 N. Sam Houston Pkwy E. Participation Type: Active Supplier  
Houston, TX 77060

Invitation Date 04/16/2021  
Invitation Type Automatic  
Invitation Email(s) Brittany@bestaffingsolutions.net

Bee Busy Wellness Center

Address 8785 W. Bellfort  
Houston, TX 77031 Participation Type: Active Supplier

Invitation Date 04/16/2021  
Invitation Type Automatic  
Invitation Email(s) n.mitchell@mybbwc.org

Beehive Specialty

Address 8701 Wall Street  
Austin, TX 78754 Participation Type: Active Supplier

Classifications HUB,WBE (Primary)

Invitation Date 04/16/2021  
Invitation Type Automatic  
Invitation Email(s) nicky@specialbee.com

Benchmark Displays, LLC

Address 44-311 Monterey Avenue  
Palm Desert, CA 92260 Participation Type: Active Supplier

Classifications SBE (Primary),WBE

Invitation Date 04/16/2021  
Invitation Type Automatic  
Invitation Email(s) info@benchmarkdisplays.com  
Response Status Viewed  
Status Date 05/12/2021

BG Technologies

Address 2301 Denton Dr.  
Austin, TX 78758 Participation Type: Active Supplier

Invitation Date 04/16/2021  
Invitation Type Automatic  
Invitation Email(s) insidesales@bg-technologies.com

BGM Company

Address 10011 Cabin Creek Dr.  
Houston, TX 77064 Participation Type: Active Supplier

Classifications SBE,WBE (Primary)

Invitation Date 04/16/2021  
Invitation Type Automatic  
Invitation Email(s) lpatek@bgmcompany.com  
Response Status Viewed  
Status Date 05/11/2021

Big Country School Supply LLC

Address 2442 Industrial Blvd  
Abilene, TX 79605 Participation Type: Active Supplier

Classifications SBE (Primary),WBE

Invitation Date 04/16/2021  
Invitation Type Automatic  
Invitation Email(s) support@bigcountryschoolsupply.com

Big Frog Custom T-Shirts & More

Address 7073 Highway 6 North  
Houston, TX 77095 Participation Type: Active Supplier

Invitation Date 04/16/2021  
Invitation Type Automatic  
Invitation Email(s) bettyl@bigfrog.com

BIG FROG OF THE WOODLANDS (Geoinvest Custom Garment, Inc)

---

Address 6531 FM 1488 Rd Participation Type: Active Supplier  
Magnolia, TX 77354

Invitation Date 04/16/2021  
Invitation Type Automatic  
Invitation Email(s) danielm@bigfrog.com

Big Hit Productions

---

Address P.O. Box 851952 Participation Type: Active Supplier  
Mesquite, TX 75185

Classifications MBE,TPA,SBE (Primary),HUB

Invitation Date 04/16/2021  
Invitation Type Automatic  
Invitation Email(s) info@bighitcreative.com

BIG MEDIA (VOSEL INTERNATIONAL, INC.)

---

Address 5710 DONIPHAN Participation Type: Active Supplier  
EL PASO, TX 79932

Classifications MBE,SBE (Primary)

Invitation Date 04/16/2021  
Invitation Type Automatic  
Invitation Email(s) daniel@bigmediasigns.com

Big Sister Little Sister

---

Address P.O. Box 300025 Participation Type: Active Supplier  
Houston, TX 77230

Classifications MBE (Primary),SBE,WBE

Invitation Date 04/16/2021  
Invitation Type Automatic  
Invitation Email(s) Cacilie@bigsisterlittlesister.org

Big Star Branding, Inc.

---

Address 4009 Naco Perrin Participation Type: Active Supplier  
San Antonio, TX 78217

Classifications TXM,SBE (Primary),HUB,WBE

Invitation Date 04/16/2021  
Invitation Type Automatic  
Invitation Email(s) bsdev@bigstarbranding.com

BJ's Tees, LLC

---

Address 2206A Old Ranch Rd 12 Participation Type: Active Supplier  
San Marcos, TX 78666

Invitation Date 04/16/2021  
Invitation Type Automatic  
Invitation Email(s) bjs.tees.llc@gmail.com

Blackland Glass & Construction

---

Address 120 Taylor Plaza Drive Participation Type: Active Supplier  
Greenville, TX 75402

Invitation Date 04/16/2021  
Invitation Type Automatic  
Invitation Email(s) billy@blacklandglass.com

Blink Marketing Inc

Address 1925 St. Clair Ave. Participation Type: Active Supplier  
Cleveland, OH 44114

Invitation Date 04/16/2021  
Invitation Type Automatic  
Invitation Email(s) bids@blinksigns.com  
Response Status Unsubmitted  
Status Date 05/21/2021

Blink Marketing, Inc.

Address 318 Seaboard Lane Participation Type: Active Supplier  
Franklin, TN 37067

Classifications SBE (Primary),WBE

Invitation Date 04/16/2021  
Invitation Type Automatic  
Invitation Email(s) jenny@blinkmarketing.com  
Response Date 05/18/2021  
Response Status Submitted  
Status Date 05/18/2021

BLU PHIRE RESEARCH INSTITUTE INC

Address 7710 CHERRY PARK DR STE. T518 Participation Type: Active Supplier  
HOUSTON, TX 77095

Invitation Date 04/16/2021  
Invitation Type Automatic  
Invitation Email(s) info@bluphireri.com

Blue Moose Tees (Bloose LLC)

Address 912 113th Street Participation Type: Active Supplier  
Arlington, TX 76011

Classifications TAS,TIP (Primary)

Invitation Date 04/16/2021  
Invitation Type Automatic  
Invitation Email(s)

BLUE RIBBON STYLES CO

Address 6534 S LAVERGNE AVENUE Participation Type: Active Supplier  
BEDFORD PARK, IL 60638

Classifications MBE,TAS,SBE (Primary),WBE

Invitation Date 04/16/2021  
Invitation Type Automatic  
Invitation Email(s) AMANDA@BLUERIBBONSTYLES.COM

Blue Wave Apparel

Address P.O. Box 276 Participation Type: Active Supplier  
Pinehurst, TX 77362

Invitation Date 04/16/2021  
Invitation Type Automatic  
Invitation Email(s) info@bluewaveapparel.com

BluGreen Pest Control

Address PO Box 632 Participation Type: Active Supplier  
Wallis, TX 77485

Invitation Date 04/16/2021  
Invitation Type Automatic  
Invitation Email(s) cdrymala@live.com

**BMP Vision**

---

Address 18600 S. Park View  
Houston, TX 77084 Participation Type: Active Supplier

Invitation Date 04/16/2021  
Invitation Type Automatic  
Invitation Email(s) yourvision@bmpvision.com

**BNP Creations**

---

Address 828 Marina Bay Dr.  
Kemah, TX 78565 Participation Type: Active Supplier

Classifications SBE (Primary),WBE

Invitation Date 04/16/2021  
Invitation Type Automatic  
Invitation Email(s) blancaperry@bnpcreations.com

**Bolo Stick LLC**

---

Address PO Box 8626  
Warren, OH 44484 Participation Type: Active Supplier

Invitation Date 04/16/2021  
Invitation Type Automatic  
Invitation Email(s) bill@bolostick.net

**Bonheur Embroidery**

---

Address 8501 Angus Dr.  
Justin, TX 76247 Participation Type: Active Supplier

Classifications MBE (Primary),SBE,WBE

Invitation Date 04/16/2021  
Invitation Type Automatic  
Invitation Email(s) bonheurembroidery@gmail.com

**BookerDezigns**

---

Address 6910 Misty Morning Trace  
Richmond, TX 77407 Participation Type: Active Supplier

Classifications MBE (Primary),SBE

Invitation Date 04/16/2021  
Invitation Type Automatic  
Invitation Email(s) Cornelius.Booker@ymail.com

**Boost Promotions**

---

Address 1192 Draper Pkwy #515'  
Draper, UT 84020 Participation Type: Active Supplier

Invitation Date 04/16/2021  
Invitation Type Automatic  
Invitation Email(s)

**Boss & Hughes**

---

Address PO Box 838  
Bellaire, TX 77402 Participation Type: Active Supplier

Classifications MBE (Primary),HGA,TAS,SBE,HUB,WBE

Invitation Date 04/16/2021  
Invitation Type Automatic  
Invitation Email(s) asha@bosshughes.com  
Response Status Viewed  
Status Date 05/13/2021



Boundless Network

---

Address 5151 Edloe  
Houston, TX 77005 Participation Type: Active Supplier

Invitation Date 04/16/2021  
Invitation Type Automatic  
Invitation Email(s) llerner@BoundlessNetwork.com

Brady Hull & Associates, L.C.

---

Address 26414 Oak Ridge Dr  
The Woodlands, TX 77380 Participation Type: Active Supplier

Invitation Date 04/16/2021  
Invitation Type Automatic  
Invitation Email(s) Brady@bradyhull.com

Brame Specialty Company Inc.

---

Address P.O. Box 271  
Durham, NC 27702 Participation Type: Active Supplier

Invitation Date 04/16/2021  
Invitation Type Automatic  
Invitation Email(s)

Brand IQ, LC

---

Address 12554 Hwy 3  
Webster, TX 77598 Participation Type: Active Supplier

Invitation Date 04/16/2021  
Invitation Type Automatic  
Invitation Email(s) micael.shea@BrandIQinc.com  
Response Date 05/17/2021  
Response Status Submitted  
Status Date 05/17/2021

Brandit LLC

---

Address 5105-A N 10th St  
McAllen, TX 78504 Participation Type: Active Supplier

Classifications SBE (Primary),HUB

Invitation Date 04/16/2021  
Invitation Type Automatic  
Invitation Email(s) branditrgv@gmail.com  
Response Date 05/18/2021  
Response Status Submitted  
Status Date 05/18/2021

BRANDMARK

---

Address 4841 S. Jackson  
Edinburg, TX 78539 Participation Type: Active Supplier

Classifications HUB (Primary)

Invitation Date 04/16/2021  
Invitation Type Automatic  
Invitation Email(s) info@branmk.com

Brandwurx (Black Loyal)

---

Address 2153 East Jones Ave  
Phoenix, AZ 85040 Participation Type: Active Supplier

Invitation Date 04/16/2021  
Invitation Type Automatic  
Invitation Email(s) dwayne@brandwurx.com

Brentwood Marketing, LLC

Address PO Box 11329  
Spring, TX 77391 Participation Type: Active Supplier

Invitation Date 04/16/2021  
Invitation Type Automatic  
Invitation Email(s) patrickwaindel@cs.com

Briar Patch

Address 12283-A Veterans Memorial Dr.  
Houston, TX 77067 Participation Type: Active Supplier

Classifications MBE (Primary),SBE,WBE

Invitation Date 04/16/2021  
Invitation Type Automatic  
Invitation Email(s) tpensonwilson@yahoo.com

BRIDGEFARMER'S INC

Address 1938 Picadilly Dr  
round rock, TX 78664 Participation Type: Active Supplier

Invitation Date 04/16/2021  
Invitation Type Automatic  
Invitation Email(s) jbridgefarmer@aol.com

Brigitte DeJohn

Address 188 CR 3017A  
Dayton, TX 77535 Participation Type: Active Supplier

Invitation Date 04/16/2021  
Invitation Type Automatic  
Invitation Email(s) bdejohn@hotmail.com

Brookside Specialties (Together, Inc.)

Address 802 East 6th Street  
Tulsa, OK 74120 Participation Type: Active Supplier

Classifications MBE,SBE (Primary)

Invitation Date 04/16/2021  
Invitation Type Automatic  
Invitation Email(s) pnlady@aol.com

Brucelli Advertising

Address 310 S. Blakely St.  
Dunmore, PA 18512 Participation Type: Active Supplier

Invitation Date 04/16/2021  
Invitation Type Automatic  
Invitation Email(s) nancy@brucelli.com

BSN Sports, LLC (Varsity Brands Holding Co., Inc.)

Address PO Box 660176  
Dallas, TX 75266-0176 Participation Type: Active Supplier

Classifications TAS (Primary),TCP,USC

Invitation Date 04/16/2021  
Invitation Type Automatic  
Invitation Email(s) bsnbid@bsnsports.com

Buffalo Specialties, Inc

---

Address 10706 CRAIGHEAD DRIVE Participation Type: Active Supplier  
Houston, TX 77025

Classifications SBE

Invitation Date 04/16/2021  
Invitation Type Automatic  
Invitation Email(s) tryerson@buffspec.com  
Response Date 05/03/2021  
Response Status Submitted  
Status Date 05/03/2021

BuildASign

---

Address 11525A Stonehollow Dr., Ste. 100 Participation Type: Active Supplier  
Austin, TX 78758

Invitation Date 04/16/2021  
Invitation Type Automatic  
Invitation Email(s) dorelia.miller@buildasign.com

BullShirts, Inc

---

Address 5485 W Sam Houston PKWY N Participation Type: Active Supplier  
Houston, TX 77041

Classifications HUB (Primary)

Invitation Date 04/16/2021  
Invitation Type Automatic  
Invitation Email(s)

Butler Business Products, LLC

---

Address 6942 Signat Dr. Participation Type: Active Supplier  
Houston, TX 77041

Classifications MBE,HUB,WBE

Invitation Date 04/16/2021  
Invitation Type Automatic  
Invitation Email(s) sduke@butlerbusinessproducts.com  
Response Date 05/18/2021  
Response Status Submitted  
Status Date 05/18/2021

Byfaith Design (Darnell Caldwell)

---

Address 2405 Taylor St Participation Type: Active Supplier  
Dallas, TX 75201

Invitation Date 04/16/2021  
Invitation Type Automatic  
Invitation Email(s) dcaldwell@byfaithdesign.us

C&H Distributors, LLC

---

Address 22133 Network Pl Participation Type: Active Supplier  
Chicago, IL 60673

Classifications TXM (Primary)

Invitation Date 04/16/2021  
Invitation Type Automatic  
Invitation Email(s) governmentsales@chdistgov.com

C2 Imaging

Address 6650 Roxburgh Dr. Participation Type: Active Supplier  
Houston, TX 77041

Invitation Date 04/16/2021  
Invitation Type Automatic  
Invitation Email(s) michael.waits@c2imaging.com mike.morgan@c2imaging.com nancy.pearson@c2imaging.com

Calfee Specialties (BLUE RIBBON PROMOTIONS LLC)

Address 312 Longmire Rd Participation Type: Active Supplier  
Conroe, TX 77304

Classifications HUB,WBE

Invitation Date 04/16/2021  
Invitation Type Automatic  
Invitation Email(s) debbieh@calfeespecialties.com  
Response Date 05/18/2021  
Response Status Submitted  
Status Date 05/18/2021

California

Address 707 3rd Street Participation Type: Active Supplier  
West Sacramento, CA 95605

Invitation Date 04/16/2021  
Invitation Type Manual  
Invitation Email(s)

Camelback Displays Inc.

Address 20020 Hickory Twig Way Participation Type: Active Supplier  
Spring, TX 77388

Classifications SBE (Primary)

Invitation Date 04/16/2021  
Invitation Type Automatic  
Invitation Email(s) contact@camelbackdisplays.com

Capitol Flag Co., Inc.

Address 4822 Fannin Street Participation Type: Active Supplier  
Houston, TX 77004

Invitation Date 04/16/2021  
Invitation Type Automatic  
Invitation Email(s) capitofflag@earthlink.net

Caprice Productions, Inc

Address 1935 Sable Lane Participation Type: Active Supplier  
San Antonio, TX 78217

Classifications MBE,HUB (Primary),WBE

Invitation Date 04/16/2021  
Invitation Type Automatic  
Invitation Email(s) cathy@capriceproductions.com

Career Uniforms (Radia Enterprises Inc)

Address 7738 Park Place Blvd Participation Type: Active Supplier  
Houston, TX 77087

Classifications MBE,SBE,HUB (Primary)

Invitation Date 04/16/2021  
Invitation Type Automatic  
Invitation Email(s) sales@careeruniforms.com

Carlisle Life Products LLC

Address 7911 Trabajo Dr. Participation Type: Active Supplier  
Houston, TX 77083

Invitation Date 04/16/2021  
Invitation Type Automatic  
Invitation Email(s) darlene@parent-grams.com

Carney Educational Services

Address 430 Grand Cypress, Suite 103 Participation Type: Active Supplier  
Palmdale, CA 93551

Invitation Date 04/16/2021  
Invitation Type Automatic  
Invitation Email(s) sergiot@carneyed.com

CAROLINA INDUSTRIAL MAT CO., INC

Address 1401 SUMNER RD Participation Type: Active Supplier  
THOMASVILLE, NC 27360

Classifications SBE (Primary),WBE

Invitation Date 04/16/2021  
Invitation Type Automatic  
Invitation Email(s) industrial@northstate.net

Cassidel Crative Embroidery Designs (Cassie Mitchell)

Address 3102 Nita st. Participation Type: Active Supplier  
Houston, TX 77051

Classifications MBE,SBE (Primary),WBE

Invitation Date 04/16/2021  
Invitation Type Automatic  
Invitation Email(s) Cassidelemb@gmail.com

Catalyst PR INC

Address 1701 N Thompson St Participation Type: Active Supplier  
Conroe, TX 77301-1989

Classifications SBE,HUB (Primary),WBE

Invitation Date 04/16/2021  
Invitation Type Automatic  
Invitation Email(s) holly@catalystpr.net  
Response Status Viewed  
Status Date 05/11/2021

Cedar Promo (PS Promotional Solutions LLC)

Address 2807 Allen Street #406 Participation Type: Active Supplier  
Dallas, TX 75204

Invitation Date 04/16/2021  
Invitation Type Automatic  
Invitation Email(s) jake@cedarpromo.com

Celebrate Student Success, LLC

Address 2910 Commercial Center Blvd Suite 103; Participation Type: Active Supplier  
Box #123  
Katy, TX 77494

Invitation Date 04/16/2021  
Invitation Type Automatic  
Invitation Email(s) info@CelebrateStudentSuccess.com

Central IT Company LLC

Address 448 West 19th St, Suite 412  
Houston, TX 77008 Participation Type: Active Supplier

Classifications MBE,SBE (Primary),WBE

Invitation Date 04/16/2021  
Invitation Type Automatic  
Invitation Email(s) mario@centralitco.com

CFJ Manufacturing

Address 5001 N Freeway  
Fort Worth, TX 76106 Participation Type: Active Supplier

Classifications WBE (Primary)

Invitation Date 04/16/2021  
Invitation Type Automatic  
Invitation Email(s)

Challenge Office Products

Address 6015 South Loop East  
Houston, TX 77033 Participation Type: Active Supplier

Classifications MBE,HUB

Invitation Date 04/16/2021  
Invitation Type Automatic  
Invitation Email(s) jbarbosa@challengeofficeproducts.com mbarbosa@challengeofficeproducts.com  
Response Status Unsubmitted  
Status Date 05/12/2021

CHAMPION AWARDS

Address 2627 N Texas Blvd  
Weslaco, TX 78599 Participation Type: Active Supplier

Classifications HUB (Primary)

Invitation Date 04/16/2021  
Invitation Type Automatic  
Invitation Email(s) juan@champtx.com

Champion Teamwear (It's Greek To Me, Inc)

Address PO Box 959741  
St Louis, MO 63195-9741 Participation Type: Active Supplier

Invitation Date 04/16/2021  
Invitation Type Automatic  
Invitation Email(s) mhk-gtmbids@hanes.com  
Response Date 05/18/2021  
Response Status No Bid  
Status Date 05/18/2021

Chase in Dreams, Speech and Drama (Deadra Chase)

Address 14127 Pinewest  
Houston, TX 77049 Participation Type: Active Supplier

Invitation Date 04/16/2021  
Invitation Type Automatic  
Invitation Email(s) chasemsD@yahoo.com

Cheatham & Associates Corp

Address 15851 Dallas Pkwy, Suite 600 Participation Type: Active Supplier  
Addison, TX 75001

Invitation Date 04/16/2021  
Invitation Type Automatic  
Invitation Email(s) kcheatham@zoho.com

Cheerleading Company (Movie Show Video Mgt., Inc.)

Address 11350 Hillguard Road Participation Type: Active Supplier  
Dallas, TX 75243

Invitation Date 04/16/2021  
Invitation Type Automatic  
Invitation Email(s) bids@cheerleading.com

Cheers, Etc., Inc.

Address 210 Bronze Street Participation Type: Active Supplier  
Garland, TX 75042

Classifications WBE (Primary)  
Invitation Date 04/16/2021  
Invitation Type Automatic  
Invitation Email(s) cheersetc@gmail.com

Child Care Associates

Address 3000 E BELKNAP ST Participation Type: Active Supplier  
FORT WORTH, TX 76111-4142

Invitation Date 04/16/2021  
Invitation Type Automatic  
Invitation Email(s) patricia.looper@childcareassociates.org

Child Safety Solutions

Address 75 Mechanic Street Participation Type: Active Supplier  
Rockland, ME 04841

Classifications SBE (Primary),WBE  
Invitation Date 04/16/2021  
Invitation Type Automatic  
Invitation Email(s) david@imsafe.com

Christian Brothers Tees

Address 2857 Bluffview Drive Participation Type: Active Supplier  
Lewisville, TX 75067

Invitation Date 04/16/2021  
Invitation Type Automatic  
Invitation Email(s) cbteetx@gmail.com

CIELO VISTA UNLIMITED LLC (CIELO VISTA UNIFORMS & MORE)

Address 1926 LINGARD PARK COURT Participation Type: Active Supplier  
HOUSTON, TX 77047

Classifications MBE (Primary),SBE  
Invitation Date 04/16/2021  
Invitation Type Automatic  
Invitation Email(s) info@cielovistastore.com

cleaningessence LLC

Address 19716 SAUMS RD  
HOUSTON, TX 77084 Participation Type: Active Supplier

Classifications SBE (Primary)

Invitation Date 04/16/2021  
Invitation Type Automatic  
Invitation Email(s) john.taylor@cleaningessence.com

Clever Items

Address 333 Exchange Drive  
Arlington, TX 76011 Participation Type: Active Supplier

Invitation Date 04/16/2021  
Invitation Type Automatic  
Invitation Email(s) cleveritems@att.net

Club Colors Buyer LLC

Address 420 East State Parkway  
Schaumburg, IL 60173 Participation Type: Active Supplier

Invitation Date 04/16/2021  
Invitation Type Automatic  
Invitation Email(s)

CME Printing, Inc.

Address 8181 Commerce Park, Ste 708  
Houston, TX 77036 Participation Type: Active Supplier

Invitation Date 04/16/2021  
Invitation Type Automatic  
Invitation Email(s) kmalone@cmeprinting.com

Coach Mercer LLC

Address 21919 Clay Rd Apt 5107  
Katy, TX 77449 Participation Type: Active Supplier

Invitation Date 04/16/2021  
Invitation Type Automatic  
Invitation Email(s) chris.mercer@coach-merc.com  
Response Status Viewed  
Status Date 05/17/2021

Coastal Enterprises (Joy Products of California, Inc)

Address 17281 Mount Wynne Circle  
Fountain Valley, CA 92708 Participation Type: Active Supplier

Classifications WBE (Primary)

Invitation Date 04/16/2021  
Invitation Type Automatic  
Invitation Email(s) goods@coastalsportswear.com

Coastal Office Solutions

Address 1514 N. Ben Jordan Suite B  
Victoria, TX 77901 Participation Type: Active Supplier

Classifications HUB (Primary)

Invitation Date 04/16/2021  
Invitation Type Automatic  
Invitation Email(s) shad@coastaltx.com



Cole Enterprise LLC (IGWT Partners)

Address 352 W.NORTHFIELD BLVD SUITE N Participation Type: Active Supplier  
Murfreesboro, TN 37129

Classifications MBE (Primary)

Invitation Date 04/16/2021  
Invitation Type Automatic  
Invitation Email(s) Timothy.cole@coleenterprisellc.com

Comflow Mechanical Services

Address 6411 Lawford Lane Participation Type: Active Supplier  
Houston, TX 77040

Invitation Date 04/16/2021  
Invitation Type Automatic  
Invitation Email(s) cevett@comflowco.com

CompuPro Global (Rita's Tape Media)

Address 4888 Langfield Road Participation Type: Active Supplier  
Houston, TX 77040

Classifications SBE,WBE (Primary)

Invitation Date 04/16/2021  
Invitation Type Automatic  
Invitation Email(s) ginnib@compuproglobal.com

Concept uniform co

Address 237 E. 8th Ave Participation Type: Active Supplier  
Homestead, PA 15120

Classifications SBE (Primary)

Invitation Date 04/16/2021  
Invitation Type Automatic  
Invitation Email(s) conunf@cs.com

Connecticut

Address 450 Columbus Boulevard, Suite 5 Participation Type: Active Supplier  
Hartford, CT 06103

Invitation Date 04/16/2021  
Invitation Type Manual  
Invitation Email(s)

ConServ Flag Company

Address 1003 Illinois ST Participation Type: Active Supplier  
Sidney, NE 69162

Classifications TIP,SBE (Primary)

Invitation Date 04/16/2021  
Invitation Type Automatic  
Invitation Email(s) kenny@conservflag.com

Construction Journal

Address 400 SW 7th Street Participation Type: Active Supplier  
Stuart, FL 34994

Invitation Date 04/16/2021  
Invitation Type Automatic  
Invitation Email(s)

Copy Stop Print and Postal (Texas Printing and Publishing)

---

Address 2290 Boonville Rd Ste 800 Participation Type: Active Supplier  
Bryan, TX 77802

Invitation Date 04/16/2021  
Invitation Type Automatic  
Invitation Email(s) sales@copystopprint.com

Corporate Incentives, Inc

---

Address 26414 Oak Ridge Dr. Participation Type: Active Supplier  
The Woodlands, TX 77380

Classifications TCP,TIP,SBE (Primary),HUB,WBE

Invitation Date 04/16/2021  
Invitation Type Automatic  
Invitation Email(s)  
Response Status Unsubmitted  
Status Date 05/11/2021

Council Rock Enterprises, LLC

---

Address 11 Centre Park Participation Type: Active Supplier  
Rochester, NY 14614

Classifications MBE,SBE,HUB (Primary)

Invitation Date 04/16/2021  
Invitation Type Automatic  
Invitation Email(s)

Creative Concepts Printing, Graphics

---

Address 40311 FM 1960 Rd. West Participation Type: Active Supplier  
Houston, TX 77068

Classifications MBE,SBE (Primary)

Invitation Date 04/16/2021  
Invitation Type Automatic  
Invitation Email(s) creativeconcepts@hotmail.com

Crestline Co Inc (Crestline Specialties Inc)

---

Address PO Box 2027 Participation Type: Active Supplier  
Lewiston, ME 04241

Invitation Date 04/16/2021  
Invitation Type Automatic  
Invitation Email(s)

Crestline Specialties Inc

---

Address 70 Mt Hope Ave Participation Type: Active Supplier  
Lewiston, ME 04240

Classifications TCP (Primary),TIP

Invitation Date 04/16/2021  
Invitation Type Automatic  
Invitation Email(s)

Crown Trophy (Seabrook Trophy & Awards)

---

Address 2168 Bayprot Blvd Participation Type: Active Supplier  
Seabrook, TX 77586

Classifications WBE (Primary)

Invitation Date 04/16/2021  
Invitation Type Automatic  
Invitation Email(s) crownsea@sbcglobal.net

Cryogenic Plastics dba Pageantry World (Cryogenic Plastics Inc.)

Address 1098 Windy Hill Road Participation Type: Active Supplier  
Kyle, TX 78640

Classifications SBE (Primary)

Invitation Date 04/16/2021  
Invitation Type Automatic  
Invitation Email(s) susan@cpitx.com

Curtis 1000

Address 710 Mantooth Participation Type: Active Supplier  
Lufkin, TX 75904

Invitation Date 04/16/2021  
Invitation Type Automatic  
Invitation Email(s) mamiller@curtis1000.com

CUSTOM CREATIONS

Address 8111 BERKELY CT Participation Type: Active Supplier  
Baytown, TX 77521

Invitation Date 04/16/2021  
Invitation Type Automatic  
Invitation Email(s) customcreationsbycc@yahoo.com

Custom Pins, Inc.

Address 25 Old Orchard Road Participation Type: Active Supplier  
Rye Brook, NY 10573

Invitation Date 04/16/2021  
Invitation Type Automatic  
Invitation Email(s) jim@custompins.com

CUSTOM SPORTSWEAR, INC.

Address 8 ENTERPRISE COURT Participation Type: Active Supplier  
SEWELL, NJ 08080

Invitation Date 04/16/2021  
Invitation Type Automatic  
Invitation Email(s) bids@customsportswear.net  
Response Date 04/28/2021  
Response Status Submitted  
Status Date 04/28/2021

Custom Wall Prints & More, LLC

Address 9818 Lynette Falls Dr Participation Type: Active Supplier  
Houston, TX 77095

Invitation Date 04/16/2021  
Invitation Type Automatic  
Invitation Email(s) capesa3@gmail.com

Cyclone FPV (Cyclone 3D, Inc.)

Address 5546 Silent Timber Path LN. Participation Type: Active Supplier  
Spring, TX 77386

Invitation Date 04/16/2021  
Invitation Type Automatic  
Invitation Email(s) schoolbids@cyclonefpv.com  
Response Status Viewed  
Status Date 05/16/2021

Cypress Station Shipping and Digital Print Solutions (united networking community)

---

Address 40 Cypress Creek Pkwy #124 Participation Type: Active Supplier  
Houston, TX 77090

Classifications MBE,SBE (Primary),WBE

Invitation Date 04/16/2021  
Invitation Type Automatic  
Invitation Email(s) alyons9715@gmail.com rkdnlc@aol.com

D.A.N.'s One Stop, LLC.

---

Address 108 Herndon Street Participation Type: Active Supplier  
Shreveport, LA 71101

Classifications MBE (Primary),SBE

Invitation Date 04/16/2021  
Invitation Type Automatic  
Invitation Email(s) dracforme@gmail.com

D3 & Sons Services

---

Address 32615 FM 2978 Participation Type: Active Supplier  
Magnolia, TX 77354

Invitation Date 04/16/2021  
Invitation Type Automatic  
Invitation Email(s) timhatchell@sbcglobal.net

Daintree Solutions LLC

---

Address 1835 Albert Glade CT Participation Type: Active Supplier  
Richmond, TX 77469

Classifications MBE (Primary),SBE,HUB

Invitation Date 04/16/2021  
Invitation Type Automatic  
Invitation Email(s) apatel@daintreesolutions.us

Dance Another World

---

Address P.O. Box 1423 Participation Type: Active Supplier  
Austin, TX 78767

Invitation Date 04/16/2021  
Invitation Type Automatic  
Invitation Email(s) ashlyn@danceanotherworld.org

Daniel's Printing Place

---

Address 623 N. Airport Dr. Ste B Participation Type: Active Supplier  
Weslaco, TX 78596

Invitation Date 04/16/2021  
Invitation Type Automatic  
Invitation Email(s) danprint1@yahoo.com

DataSpan (MRI Inc)

---

Address 15011 Trumpet Vine Lane Participation Type: Active Supplier  
Cypress, TX 77433

Invitation Date 04/16/2021  
Invitation Type Automatic  
Invitation Email(s) dwaterman@dataspan.com rbrewer@dataspan.com

David & Co.

---

Address 785 Honore Mercier Participation Type: Active Supplier  
Saint Jean Sur Richelieu, QC Canada  
J2X 3S2

Invitation Date 04/16/2021  
Invitation Type Automatic  
Invitation Email(s) yesdavid@sbcglobal.net

DBS Marketing & Promotions LLC

---

Address 24466 Pipestem Dr Participation Type: Active Supplier  
Magnolia, TX 77355

Classifications SBE (Primary),HUB,WBE

Invitation Date 04/16/2021  
Invitation Type Automatic  
Invitation Email(s) sue@dbspromo.com

DBS Texas-Houston

---

Address 1218 garden park Participation Type: Active Supplier  
deer park, TX 77536

Classifications TAS (Primary)

Invitation Date 04/16/2021  
Invitation Type Automatic  
Invitation Email(s) dbstexas1@aol.com

Delaware

---

Address 100 Enterprise Place Participation Type: Active Supplier  
Dover, DE 19904

Invitation Date 04/16/2021  
Invitation Type Manual  
Invitation Email(s)

Delta Signs and Flags

---

Address 6524 Myrtle Ave Participation Type: Active Supplier  
Glendale, NY 11385

Classifications SBE (Primary),WBE

Invitation Date 04/16/2021  
Invitation Type Automatic  
Invitation Email(s) deltaflags@yahoo.com

DEMCO, Inc.

---

Address PO Box 8048 Participation Type: Active Supplier  
Madison, WI 53708-8048

Classifications TAS (Primary),TCP,TIP

Invitation Date 04/16/2021  
Invitation Type Automatic  
Invitation Email(s) amys@demco.com quote@demco.com

Dent Enterprises LLC

---

Address 512 N. Hampton Road #405 Participation Type: Active Supplier  
DeSoto, TX 75115

Classifications MBE (Primary),HUB

Invitation Date 04/16/2021  
Invitation Type Automatic  
Invitation Email(s) dententerprisesllc@gmail.com

Descon Signage Solutions (Young & Kenady Inc.)

Address 463 Southpoint Circle  
Brownsburg, IN 46112 Participation Type: Active Supplier

Invitation Date 04/16/2021  
Invitation Type Automatic  
Invitation Email(s) michael@desconinc.com

Design 3 Graphics

Address 8322 Herts Rd  
Spring, TX 77379 Participation Type: Active Supplier

Classifications SBE (Primary),HUB,WBE

Invitation Date 04/16/2021  
Invitation Type Automatic  
Invitation Email(s) patty@design3graphics.com

Design A Tee of Fortbend

Address 16422 salida de sol  
houston, TX 77083 Participation Type: Active Supplier

Invitation Date 04/16/2021  
Invitation Type Automatic  
Invitation Email(s) melinda@design-a-t.com

DG Grafix

Address 7518 Navidad Rd.  
Houston, TX 77083 Participation Type: Active Supplier

Invitation Date 04/16/2021  
Invitation Type Automatic  
Invitation Email(s) don.terrell@dggrafix.com

DGR United

Address 6402 Oaknut Dr  
houston, TX 77088 Participation Type: Active Supplier

Classifications MBE (Primary),SBE,HUB

Invitation Date 04/16/2021  
Invitation Type Automatic  
Invitation Email(s) info@dgrunited.com

DGS Educational Products

Address 4801 Linton Blvd Unit 11A-650  
Delray Beach, FL 33445 Participation Type: Active Supplier

Invitation Date 04/16/2021  
Invitation Type Automatic  
Invitation Email(s)

Diamond S. Spiritwear (Elan Industries)

Address 3060 Story Rd. W.  
Dallas, TX 75038 Participation Type: Active Supplier

Classifications TCP,TIP (Primary)

Invitation Date 04/16/2021  
Invitation Type Automatic  
Invitation Email(s) yolanda@diamondspiritwear.com

Diann Zackery dba: The Lysander Element

Address 518 County Road 2250 Participation Type: Active Supplier  
Grapeland, TX 75844

Classifications TXM,SBE (Primary),HUB,WBE

Invitation Date 04/16/2021  
Invitation Type Automatic  
Invitation Email(s)

DIBSYS Inc

Address 4156 Teak Circle Participation Type: Active Supplier  
Naperville, IL 60564

Classifications MBE (Primary),SBE

Invitation Date 04/16/2021  
Invitation Type Automatic  
Invitation Email(s) dsaha@dibsysinc.com sandipan@dibsysinc.com

Discount Copy (Loaiza Enterprises Inc)

Address 5730 Bintliff Dr. Participation Type: Active Supplier  
Houston, TX 77036

Classifications MBE (Primary),SBE

Invitation Date 04/16/2021  
Invitation Type Automatic  
Invitation Email(s) orders@discountcopytx.com

Discovery Education Resources (Discovery Education Resources, LLC)

Address 545 Crystal Springs Dr Participation Type: Active Supplier  
Fort Worth, TX 76108

Classifications SBE (Primary)

Invitation Date 04/16/2021  
Invitation Type Automatic  
Invitation Email(s) pdeats@derk12.com

Display Graphics, Inc

Address 6400 Westpark Dr Ste 340 Participation Type: Active Supplier  
Houston, TX 77057

Classifications SBE (Primary)

Invitation Date 04/16/2021  
Invitation Type Automatic  
Invitation Email(s) diane@displaygraphics.com

Dive Quarters Inc

Address 1725 Laskin Rd Participation Type: Active Supplier  
Virginia Beach, VA 23454

Classifications SBE (Primary)

Invitation Date 04/16/2021  
Invitation Type Automatic  
Invitation Email(s)

Diversified Supply HUB (LP Diversified Supply Hub)

Address PO Box 210 Participation Type: Active Supplier  
Aledo, TX 76008

Classifications MBE,TAS,HUB,WBE (Primary)

Invitation Date 04/16/2021  
Invitation Type Automatic  
Invitation Email(s) shele@diversifiedsupplyhub.com

Dixie Flag and Banner Company

Address PO BOX 8618 Participation Type: Active Supplier  
SAN ANTONIO, TX 78208

Classifications SBE (Primary),HUB

Invitation Date 04/16/2021  
Invitation Type Automatic  
Invitation Email(s) bella@dixieflag.com

DL Stone Enterprises, LLC (Stone Enterprises)

Address 9027 Cinnabar Ct Participation Type: Active Supplier  
Garden Ridge, TX 78266

Classifications TAS,TXM,SBE,HUB (Primary)

Invitation Date 04/16/2021  
Invitation Type Automatic  
Invitation Email(s) donstone13@hotmail.com

DNH PROMOTIONAL MARKETING

Address 1 Riverway Participation Type: Active Supplier  
Houston, TX 77056

Classifications MBE,SBE (Primary),HUB,WBE

Invitation Date 04/16/2021  
Invitation Type Automatic  
Invitation Email(s) sales@dnhpromos.com

DOLPHIN GRAPHICS INC

Address 5601 BINTLIFF STE 530 Participation Type: Active Supplier  
HOUSTON, TX 77036

Invitation Date 04/16/2021  
Invitation Type Automatic  
Invitation Email(s) KEN@DOLPHINGRAPHICSINC.COM

Double J Embroidery

Address 22302 FM 149 Rd. Participation Type: Active Supplier  
Montgomery, TX 77356

Classifications HUB (Primary),WBE

Invitation Date 04/16/2021  
Invitation Type Automatic  
Invitation Email(s) doublejembroidery@hotmail.com

Dragonfly Garment & Design Corporation

Address 421 E Kingsbury Street Participation Type: Active Supplier  
Seguin, TX 78155

Classifications MBE,SBE (Primary),WBE

Invitation Date 04/16/2021  
Invitation Type Automatic  
Invitation Email(s)



Dream Catcher Learning Academy

Address 6635 Early Fall Dr  
Humble, TX 77338 Participation Type: Active Supplier

Classifications MBE,SBE (Primary),HUB,WBE

Invitation Date 04/16/2021  
Invitation Type Automatic  
Invitation Email(s) tiffany@realelegantdreams.com

Dynamic Designs (Killeen Dynamic Designs, Inc.)

Address 2100 E Stan Schlueter Loop.  
Killeen, TX 76542 Participation Type: Active Supplier

Invitation Date 04/16/2021  
Invitation Type Automatic  
Invitation Email(s) cindy@dynamicdesignsinc.com

Eagle Flags Co (American Eagle Trading Inc)

Address 9910 Harwin Dr.  
Houston, TX 77036 Participation Type: Active Supplier

Classifications SBE (Primary)

Invitation Date 04/16/2021  
Invitation Type Automatic  
Invitation Email(s) info@americaneagletradinginc.com

Eagle Mountain Flag & Flagpole (Eagle United USA, Inc.)

Address PO Box 500  
Wimberley, TX 78676 Participation Type: Active Supplier

Classifications TXM,SBE (Primary),WBE

Invitation Date 04/16/2021  
Invitation Type Automatic  
Invitation Email(s) desiree@emflag.com

East Texas T-Shirts & More (T&S Creative Designs)

Address 135 Old Groveton Rd S  
Onalaska, TX 77360 Participation Type: Active Supplier

Invitation Date 04/16/2021  
Invitation Type Automatic  
Invitation Email(s) easttexasshirts@gmail.com

Eastbay

Address 301 N Wesley Dr.  
League City, TX 77573 Participation Type: Active Supplier

Invitation Date 04/16/2021  
Invitation Type Automatic  
Invitation Email(s)

Echo Office Products

Address 10207 S. Sam Houston Pkwy.  
Houston, TX 77071 Participation Type: Active Supplier

Invitation Date 04/16/2021  
Invitation Type Automatic  
Invitation Email(s)

Educate To Edify (Educating While Black)

Address 1002 Oxford Drive  
Pearland, TX 77584 Participation Type: Active Supplier

Classifications MBE (Primary),SBE,WBE

Invitation Date 04/16/2021  
Invitation Type Automatic  
Invitation Email(s) edwhileblack@gmail.com

Educational Products, Inc.

Address Rick Phelan  
Carrollton, TX 75006 Participation Type: Active Supplier

Invitation Date 04/16/2021  
Invitation Type Automatic  
Invitation Email(s) lmorales@educationalproducts.com

EDUCATORS DEPOT INC

Address 17424 WEST GRAND PARKWAY  
SOUTH #206  
SUGAR LAND, TX 77479 Participation Type: Active Supplier

Classifications TAS,TCP,TIP,TXM

Invitation Date 04/16/2021  
Invitation Type Automatic  
Invitation Email(s) customerservice@educatorsdepot.com

Eillac Supply CO (Ricky Small)

Address P.O.Box 24773  
Houston, TX 77229 Participation Type: Active Supplier

Classifications MBE,SBE (Primary),HUB

Invitation Date 04/16/2021  
Invitation Type Automatic  
Invitation Email(s)

EL PASO BOLT & SCREW CO., INC

Address 7058 Alameda Ave  
El Paso, TX 79915 Participation Type: Active Supplier

Classifications MBE (Primary),HUB

Invitation Date 04/16/2021  
Invitation Type Automatic  
Invitation Email(s) elpasobolt1@gmail.com

Electric Bluebird Printing

Address 4102 Sam Houston Rd.  
Willis, TX 77378 Participation Type: Active Supplier

Invitation Date 04/16/2021  
Invitation Type Automatic  
Invitation Email(s) electricbluebirdprinting@gmail.com

Elementary Spirit Zone

Address P.O. Box 128  
Denton, TX 76202 Participation Type: Active Supplier

Classifications TCP,TIP,SBE (Primary)

Invitation Date 04/16/2021  
Invitation Type Automatic  
Invitation Email(s) mac@elementaryspiritzone.com

Elgin School Supply Co, Inc

Address 260 Ryan Avenue Participation Type: Active Supplier  
Chico, CA 95973

Invitation Date 04/16/2021  
Invitation Type Automatic  
Invitation Email(s) elgin260@hotmail.com

Elite Flags and Poles, Inc.

Address P.O. Box 2881 Participation Type: Active Supplier  
Cypress, TX 77410

Invitation Date 04/16/2021  
Invitation Type Automatic  
Invitation Email(s) janicek@eliteflagsandpoles.com

Elite Printing (Elite Promotional Printing, Inc.)

Address 130 Oak Place Participation Type: Active Supplier  
Houston, TX 77006

Classifications HUB (Primary),WBE

Invitation Date 04/16/2021  
Invitation Type Automatic  
Invitation Email(s)

ELITE PROMOTIONS (Rossey Galarza)

Address 50 east elizabeth street Participation Type: Active Supplier  
brownsville, TX 78520

Classifications MBE (Primary)

Invitation Date 04/16/2021  
Invitation Type Automatic  
Invitation Email(s) rossey@elite4promo.com  
Response Status Unsubmitted  
Status Date 05/11/2021

E-Logic, Inc.

Address 1025 Connecticut Avenue NW Participation Type: Active Supplier  
Washington, DC 20036

Invitation Date 04/16/2021  
Invitation Type Automatic  
Invitation Email(s) LPadilla@e-logic.us

ELP Enterprises, Inc

Address 9346 Rosstown Way Participation Type: Active Supplier  
Houston, TX 77080

Classifications MBE,DIR,TIP,SBE (Primary),HUB,WBE

Invitation Date 04/16/2021  
Invitation Type Automatic  
Invitation Email(s) martha@elpenterprisesinc.com ruthann@elpenterprisesinc.com mike@elpenterprisesinc.com

Embellish Athletics (Embellish by Best of the West Designs)

Address 101 N Ballard Participation Type: Active Supplier  
Wylie, TX 75098

Classifications WBE (Primary)

Invitation Date 04/16/2021  
Invitation Type Automatic  
Invitation Email(s) ashley@embellishathletics.com

Embroidery Creations LLC

Address 4276 Gate Crest  
San Antonio, TX 78217 Participation Type: Active Supplier

Classifications HUB (Primary)

Invitation Date 04/16/2021  
Invitation Type Automatic  
Invitation Email(s) marian@embroidco.com

EmbroidMe Corpus Christi (Ofelia P. Rios, Inc.)

Address 3906C South Padre Island Dr  
Corpus Christi, TX 78415 Participation Type: Active Supplier

Classifications MBE,SBE (Primary),WBE

Invitation Date 04/16/2021  
Invitation Type Automatic  
Invitation Email(s)

EmbroidMe Kingsville (Gihon, Inc)

Address 230 E King  
Kingsville, TX 78363 Participation Type: Active Supplier

Classifications SBE (Primary),HUB,WBE

Invitation Date 04/16/2021  
Invitation Type Automatic  
Invitation Email(s) ceccog@sbcglobal.net

EmbroidMe Northwest Houston (Holliman-Wrenn, Inc.)

Address 17375 Tomball Pkwy  
Houston, TX 77064 Participation Type: Active Supplier

Invitation Date 04/16/2021  
Invitation Type Automatic  
Invitation Email(s) cherie@embroidme-nwhouston.com

Embroidme Webster (DBH Innovations, Inc.)

Address 20801 Gulf Freeway, Ste. 22  
Webster, TX 77598 Participation Type: Active Supplier

Classifications MBE,TAS (Primary),TCP,SBE,WBE

Invitation Date 04/16/2021  
Invitation Type Automatic  
Invitation Email(s)

EMC Resurfacing

Address 7326 Palomino Bay  
San Antonio, TX 78252 Participation Type: Active Supplier

Classifications MBE (Primary),SBE,HUB

Invitation Date 04/16/2021  
Invitation Type Automatic  
Invitation Email(s) emc1construction@gmail.com

Empowered Network Services, LLC

Address 27406 Farmcreek Drive  
Huffman, TX 77336 Participation Type: Active Supplier

Invitation Date 04/16/2021  
Invitation Type Automatic  
Invitation Email(s) tom@empowerednetwork.us

EMRJ Marketing

Address 9406 Halkirk Spring, TX 77379 Participation Type: Active Supplier

Classifications SBE (Primary)

Invitation Date 04/16/2021  
Invitation Type Automatic  
Invitation Email(s) emrjsales@gmail.com

EneSportz

Address 5740 Broadway Street Ste#110 Pearland, TX 77581 Participation Type: Active Supplier

Classifications MBE,HUB,WBE (Primary)

Invitation Date 04/16/2021  
Invitation Type Automatic  
Invitation Email(s) femalesnsportz@aol.com

Entourage Yearbooks (Entourage Imaging)

Address 39 Everett Drive Princeton Junction, NJ 08550 Participation Type: Active Supplier

Invitation Date 04/16/2021  
Invitation Type Automatic  
Invitation Email(s) caitlin.kenny@entourageyearbooks.com

Equinox Marketing

Address P.O. BOX 73307 HOUSTON, TX 77388 Participation Type: Active Supplier

Classifications TAS (Primary)

Invitation Date 04/16/2021  
Invitation Type Automatic  
Invitation Email(s)

ERI

Address 222 North 3rd Street Harlingen, TX 78550 Participation Type: Active Supplier

Classifications MBE,WBE (Primary)

Invitation Date 04/16/2021  
Invitation Type Automatic  
Invitation Email(s) mtz1985@gmail.com

Escamilla & Poneck, LLP

Address 700 North St. Mary's Street, Suite 850 San Antonio, TX 78205 Participation Type: Active Supplier

Classifications MBE,SBE,HUB (Primary)

Invitation Date 04/16/2021  
Invitation Type Automatic  
Invitation Email(s) pescamilla@escamillaponeck.com

Esix Sportswear Inc.

Address 2805 W. Arkansas #202 Arlington, TX 76016 Participation Type: Active Supplier

Classifications MBE,WBE (Primary)

Invitation Date 04/16/2021  
Invitation Type Automatic  
Invitation Email(s)

Euphoria Bridal/AdvanceHospitalUniforms

Address 207 E. Camp Wisdom Rd. Participation Type: Active Supplier  
Duncanville, TX 75116

Classifications MBE (Primary),SBE,WBE

Invitation Date 04/16/2021  
Invitation Type Automatic  
Invitation Email(s) Carter.laticia@gmail.com

Evco Partners LP dba Burgoon Company

Address PO Box 1168 Participation Type: Active Supplier  
Galveston, TX 77553

Invitation Date 04/16/2021  
Invitation Type Automatic  
Invitation Email(s) office@burgooncompany.com

Exalt Printing Solutions (Exalt Printing Solutions, LLC)

Address 1628 W. Crosby Rd. Participation Type: Active Supplier  
Carrollton, TX 75006

Classifications SBE (Primary),HUB,WBE

Invitation Date 04/16/2021  
Invitation Type Automatic  
Invitation Email(s) lisa@exaltprinting.com

ExerPlay, Inc

Address 12220 N Hwy 14, Suite 5 Participation Type: Active Supplier  
Cedar Crest, NM 87008

Invitation Date 04/16/2021  
Invitation Type Automatic  
Invitation Email(s) vicki@exerplay.com

EXIMIUS COFFEE LLC

Address 5610 CLINTON DR Participation Type: Active Supplier  
HOUSTON, TX 77020

Classifications MBE,HUB (Primary)

Invitation Date 04/16/2021  
Invitation Type Automatic  
Invitation Email(s)

Exotic Creations

Address 15710 Briarstead Drive Participation Type: Active Supplier  
Missouri City, TX 77489

Invitation Date 04/16/2021  
Invitation Type Automatic  
Invitation Email(s) exotic\_creations@ymail.com

Express Children's Theatre

Address 4800 West 34th #C3 Participation Type: Active Supplier  
Houston, TX 77092

Classifications MBE (Primary),SBE

Invitation Date 04/16/2021  
Invitation Type Automatic  
Invitation Email(s) boxoffice@expresstheatre.com

Express Press

Address 1860 E St Louis St  
Springfield, MO 65802 Participation Type: Active Supplier

Invitation Date 04/16/2021  
Invitation Type Automatic  
Invitation Email(s) bids@expresspress.com

FASTSIGNS - Irving (Outstanding Graphic Solutions, Inc.)

Address 4070 N Belt Line Rd  
Irving, TX 75038 Participation Type: Active Supplier

Invitation Date 04/16/2021  
Invitation Type Automatic  
Invitation Email(s) 4@fastsigns.com

FASTSIGNS (BTB Signs LP)

Address 2535 Blue Willow Dr  
Houston, TX 77450 Participation Type: Active Supplier

Invitation Date 04/16/2021  
Invitation Type Automatic  
Invitation Email(s) bobby.heckerth@fastsigns.com

FASTSIGNS 2073

Address 1021 61st ST Suite#600-B  
GALVESTON, TX 77551 Participation Type: Active Supplier

Invitation Date 04/16/2021  
Invitation Type Automatic  
Invitation Email(s) 2073@fastsigns.com

Fifty Shades of Graphics (Sport Your Gear LLC)

Address 22448 McCleskey Rd  
New Caney, TX 77357 Participation Type: Active Supplier

Classifications SBE (Primary),HUB,WBE

Invitation Date 04/16/2021  
Invitation Type Automatic  
Invitation Email(s) admin.april@fiftyshadesofgraphics.com

Final Graphic

Address 2900 West Park Row Drive, Suite D  
Pantego, TX 76013 Participation Type: Active Supplier

Classifications MBE (Primary),TAS,TCP,TIP

Invitation Date 04/16/2021  
Invitation Type Automatic  
Invitation Email(s)

First Team Athletic Apparel (First Team Athletic Apparel, LLC)

Address 1539 River Oaks Dr. E Suite B  
Jefferson, LA 70123 Participation Type: Active Supplier

Invitation Date 04/16/2021  
Invitation Type Automatic  
Invitation Email(s) Rickey@firstteam-apparel.com

First to the Finish

Address 1325 North Broad Street  
Carlinville, TX 62626 Participation Type: Active Supplier

Invitation Date 04/16/2021  
Invitation Type Automatic  
Invitation Email(s)

Florida			
Address	4050 Esplanade Way Tallahassee, FL 32399	Participation Type:	Active Supplier
Invitation Date	04/16/2021		
Invitation Type	Manual		
Invitation Email(s)			
Forever Blossom, LLC			
Address	14359 Torrey Chase Blvd Suite G Houston, TX 77014	Participation Type:	Active Supplier
Invitation Date	04/16/2021		
Invitation Type	Automatic		
Invitation Email(s)	info.foreverblossom@gmail.com		
Forever Divine			
Address	P.O. Box 1451 Bowie, TX 76230	Participation Type:	Active Supplier
Classifications	MBE (Primary),SBE,WBE		
Invitation Date	04/16/2021		
Invitation Type	Automatic		
Invitation Email(s)	julsdivine@yahoo.com		
Fors Lux Group (Fors Lux Group Corporation)			
Address	2425 W. Loop South Houston, TX 77027	Participation Type:	Active Supplier
Invitation Date	04/16/2021		
Invitation Type	Automatic		
Invitation Email(s)	c.ashmeade@forsluxgroup.com		
Fort Worth Hightech Signs Company			
Address	3141 Joyce Dr Fort Worth, TX 76116	Participation Type:	Active Supplier
Invitation Date	04/16/2021		
Invitation Type	Automatic		
Invitation Email(s)	info@fwhtsigns.com		
Fort Worth Running Company (Kevin P. Simms LLC)			
Address	4203 Winterborne Dr Pasadena, TX 77505	Participation Type:	Active Supplier
Invitation Date	04/16/2021		
Invitation Type	Automatic		
Invitation Email(s)	fwrunchouston@gmail.com		
Forte Advertising, LLC			
Address	1422 Delgany Street Denver, AL 80202	Participation Type:	Active Supplier
Classifications	WBE (Primary)		
Invitation Date	04/16/2021		
Invitation Type	Automatic		
Invitation Email(s)	nancy@forteadvertising.com		
Fostering Stars Learning & Resource Center, Inc			
Address	6327 CALHOUN Houston, TX 77021	Participation Type:	Active Supplier
Invitation Date	04/16/2021		
Invitation Type	Automatic		
Invitation Email(s)	info@fosteringstarslearning.com		



FR Girls of Texas

Address 170 N Cedar St  
Van, TX 75790 Participation Type: Active Supplier

Invitation Date 04/16/2021  
Invitation Type Automatic  
Invitation Email(s) angie@froftexas.com

Francis Communications Inc.

Address 2914 Sanborn St.  
Amarillo, TX 79107 Participation Type: Active Supplier

Classifications SBE (Primary)

Invitation Date 04/16/2021  
Invitation Type Automatic  
Invitation Email(s) julieo@franciscom.com

FSP Designs (Matthew Geiger)

Address 331 W Chestnut Ave  
Monrovia, CA 91016 Participation Type: Active Supplier

Classifications SBE (Primary)

Invitation Date 04/16/2021  
Invitation Type Automatic  
Invitation Email(s) sales@fspdesigns.com  
Response Status Unsubmitted  
Status Date 05/16/2021

Fully Promoted of Magnolia, Tx (Owner)

Address 10540 FM 1488 Rd  
Magnolia, TX 77354 Participation Type: Active Supplier

Classifications WBE (Primary)

Invitation Date 04/16/2021  
Invitation Type Automatic  
Invitation Email(s) kim.roberts@fullypromoted.com

Fundraising Forever

Address 23110 Lodgepoint Drive  
Katy, TX 77494 Participation Type: Active Supplier

Invitation Date 04/16/2021  
Invitation Type Automatic  
Invitation Email(s) daronson7@gmail.com

Funkytown Threads (Gary Lawrence)

Address 7370 Dogwood Park Dr  
Richalnd Hills, TX 76118 Participation Type: Active Supplier

Invitation Date 04/16/2021  
Invitation Type Automatic  
Invitation Email(s) bids@funkytownthreads.com

G & G Sign Studio LLC

Address 4410 Dillon Ln  
Corpus Christi, TX 78415 Participation Type: Active Supplier

Classifications SBE (Primary)

Invitation Date 04/16/2021  
Invitation Type Automatic  
Invitation Email(s) nancy@gandgsignstudio.com

G & K Services

Address 7355 Denny Street  
Houston, TX 77040 Participation Type: Active Supplier

Classifications TAS (Primary)

Invitation Date 04/16/2021  
Invitation Type Automatic  
Invitation Email(s)

GA ADVERTISING (FIDELFO LOZANO JR)

Address 10504 WINROCK DR  
LAREDO, TX 78045 Participation Type: Active Supplier

Classifications MBE,HGA,SBE (Primary),HUB

Invitation Date 04/16/2021  
Invitation Type Automatic  
Invitation Email(s) fidelfo@gaadvertising.net

Gameday Sports Apparel

Address 2140 Hall Johnson Road  
Grapevine, TX 76051 Participation Type: Active Supplier

Invitation Date 04/16/2021  
Invitation Type Automatic  
Invitation Email(s) ro@gsafit.com

Garden State Highway Products, Inc.

Address 301 Riverside Drive  
Millville, NJ 08332 Participation Type: Active Supplier

Classifications SBE (Primary),WBE

Invitation Date 04/16/2021  
Invitation Type Automatic  
Invitation Email(s) robert@gshpinc.com

Gateway Printing & Office Supply, Inc.

Address 315 S. Closner  
Edinburg, TX 78539 Participation Type: Active Supplier

Classifications DIR,TXM (Primary)

Invitation Date 04/16/2021  
Invitation Type Automatic  
Invitation Email(s) butch@gatewayp.com edel@gatewayp.com

Gazelle Capital, LLC

Address 6785 58TH AVE N  
Saint Petersburg, FL 33709 Participation Type: Active Supplier

Classifications SBE (Primary)

Invitation Date 04/16/2021  
Invitation Type Automatic  
Invitation Email(s) bids@gazelle.capital

GBI INK / PRINTING & PROMOTIONS (GBI ENTERPRISES)

Address P.O. Box 173  
CONROE, TX 77304 Participation Type: Active Supplier

Invitation Date 04/16/2021  
Invitation Type Automatic  
Invitation Email(s) info@gbink.com

GBPDIRECT (dean)

Address 133 East Third Street  
Kenner, LA 70062 Participation Type: Active Supplier

Classifications WBE (Primary)

Invitation Date 04/16/2021  
Invitation Type Automatic  
Invitation Email(s) gdurbin@austin.rr.com

Geaux Crates & Storage, LLC

Address 14504 North Freeway  
Houston, TX, TX 77090 Participation Type: Active Supplier

Invitation Date 04/16/2021  
Invitation Type Automatic  
Invitation Email(s) kerry@geauxcrates.com

Gene's Machine, INC.

Address 235 Leeper Lane  
Victoria, TX 77904 Participation Type: Active Supplier

Invitation Date 04/16/2021  
Invitation Type Automatic  
Invitation Email(s) mattapodackis@genesmachine.com

Get Brand Out

Address 136 Baxter Street Unit 1B  
New York, NY 10013 Participation Type: Active Supplier

Classifications SBE (Primary)

Invitation Date 04/16/2021  
Invitation Type Automatic  
Invitation Email(s)

Getting Sorted (G. Yess Fisher & Co., LLC)

Address 34 Stargazer Pl  
The Woodlands, TX 77381 Participation Type: Active Supplier

Invitation Date 04/16/2021  
Invitation Type Automatic  
Invitation Email(s) Gayle.Fisher@usa.net

Glad Rags

Address 103 Mason Dr.  
Dayton, TX 77535 Participation Type: Active Supplier

Invitation Date 04/16/2021  
Invitation Type Automatic  
Invitation Email(s) GLADRAGSDAYTON@GMAIL.COM

Gladius WPTB

Address 12643 Bassbrook lane  
tampa, FL 33626 Participation Type: Active Supplier

Classifications SBE (Primary)

Invitation Date 04/16/2021  
Invitation Type Automatic  
Invitation Email(s) wpate@fusionmedical.us

Glendale Parade Store, LLC

Address 12754 O'CONNOR ROAD Participation Type: Active Supplier  
SAN ANTONIO, TX 78233

Invitation Date 04/16/2021  
Invitation Type Automatic  
Invitation Email(s) ronda@glendale.com

Global Equipment Company Inc. (Global Industrial, Global Industrial Equipment)

Address 29833 Network Place Participation Type: Active Supplier  
Chicago, IL 60673-1298

Invitation Date 04/16/2021  
Invitation Type Automatic  
Invitation Email(s) k12bids@globalindustrial.com

Global Safety Solutions

Address 1318 Underwood Rd Suite 110 Participation Type: Active Supplier  
Deer Park, TX 77508

Classifications SBE (Primary),WBE  
Invitation Date 04/16/2021  
Invitation Type Automatic  
Invitation Email(s) bob.randecker@assistpluscorp.com

Global Xpress Promotions (GXP Ventures, LLC)

Address PO Box 796792 Participation Type: Active Supplier  
Dallas, TX 75379

Invitation Date 04/16/2021  
Invitation Type Automatic  
Invitation Email(s) MarshallB@Global-XP.com

Globe Electric Supply (Globe Electric Supply, Inc.)

Address 10902 Roark Rd Participation Type: Active Supplier  
Houston, TX 77099

Classifications MBE,TPA,TXM,WBE (Primary)  
Invitation Date 04/16/2021  
Invitation Type Automatic  
Invitation Email(s) stever@globeelectric.com

Globe Office Products

Address 11500 FM 1960 W, Suite 215 Participation Type: Active Supplier  
Houston, TX 77065

Classifications MBE,SBE (Primary)  
Invitation Date 04/16/2021  
Invitation Type Automatic  
Invitation Email(s) globeoff@hotmail.com

Golden Gate

Address 216, Manhae-ro Participation Type: Active Supplier  
Ansan, Gyeonggi-do Korea, Democratic  
People's Republic of 15422

Response Status Viewed  
Status Date 05/11/2021

Golden Mountain Consulting L.L.C

Address 12710 Widley Circle Participation Type: Active Supplier  
Houston, TX 77077

Invitation Date 04/16/2021  
Invitation Type Automatic  
Invitation Email(s) goldenmountainconsultant@gmail.com

Graduate Sales & Recognition

Address 3336 Spring Stuebner Participation Type: Active Supplier  
Spring, TX 77389

Classifications SBE (Primary)

Invitation Date 04/16/2021  
Invitation Type Automatic  
Invitation Email(s) kenney@mygradaccount.com

Graphic Solutions Inc

Address 4793 adams rd Participation Type: Active Supplier  
hixson, TN 37343

Classifications SBE (Primary)

Invitation Date 04/16/2021  
Invitation Type Automatic  
Invitation Email(s) jsimpson@godecals.net

Graphics Store

Address 7558 Sand Street Participation Type: Active Supplier  
Fort Worth, TX 76118

Invitation Date 04/16/2021  
Invitation Type Automatic  
Invitation Email(s)

Graphics Unlimited, Inc.

Address 213 Kernohan Participation Type: Active Supplier  
Crosby, TX 77532

Invitation Date 04/16/2021  
Invitation Type Automatic  
Invitation Email(s) tony@graphicsunlimitedinc.net faith@graphicsunlimitedinc.net  
Response Date 05/14/2021  
Response Status Submitted  
Status Date 05/14/2021

Green Mango Marketing

Address 1717 Frazier St. Suite G Participation Type: Active Supplier  
Conroe, TX 77301

Invitation Date 04/16/2021  
Invitation Type Automatic  
Invitation Email(s)

GreenGo 2020

Address 118 Dresden Participation Type: Active Supplier  
Houston, TX 77012

Classifications MBE (Primary)

Invitation Date 04/16/2021  
Invitation Type Automatic  
Invitation Email(s) Olarafa@aol.com

Greenwood Office Outfitters

Address 2951 Suffolk Drive  
Fort Worth, TX 76133 Participation Type: Active Supplier

Invitation Date 04/16/2021  
Invitation Type Automatic  
Invitation Email(s)

Groggy Dog Sportswear & Graphics Design

Address 4017 Mesa Drive  
Denton, TX 76207 Participation Type: Active Supplier

Classifications TCP,TIP,SBE (Primary)

Invitation Date 04/16/2021  
Invitation Type Automatic  
Invitation Email(s) mchambers@groggydogonline.com

Ground Zero Marketing

Address 705-2 E Bidwell St. #279  
Folsom, CA 95630 Participation Type: Active Supplier

Classifications SBE,WBE (Primary)

Invitation Date 04/16/2021  
Invitation Type Automatic  
Invitation Email(s) orders@groundzeromktg.com

Grunwald Printing Company, Inc.

Address 276 Lakeside Hills Drive  
Montgomery, TX 77316 Participation Type: Active Supplier

Classifications SBE (Primary)

Invitation Date 04/16/2021  
Invitation Type Automatic  
Invitation Email(s) lisa@gpprint.com

GT Distributors, Inc.

Address P.O. Box 16080  
Austin, TX 78761-6080 Participation Type: Active Supplier

Classifications TAS,TPA,SBE (Primary)

Invitation Date 04/16/2021  
Invitation Type Automatic  
Invitation Email(s) txbids@gtdist.com

Gulf Coast Athletic Supply

Address 120 Industrial Blvd.  
Sugar Land, TX 77478 Participation Type: Active Supplier

Classifications SBE (Primary)

Invitation Date 04/16/2021  
Invitation Type Automatic  
Invitation Email(s) mkalinec@gulfcoastathletics.com

Gulf Coast Nut & Bolt LLC

Address 4501 Leopard st  
Corpus Christi, TX 78408 Participation Type: Active Supplier

Invitation Date 04/16/2021  
Invitation Type Automatic  
Invitation Email(s) Paul@gcnbolt.com

Gurrola Reprographics Inc.

Address 6161 Washington Ave. Participation Type: Active Supplier  
Houston, TX 77007

Classifications MBE,SBE (Primary)

Invitation Date 04/16/2021  
Invitation Type Automatic  
Invitation Email(s)

H.D.I.

Address 5308 Chenevert Participation Type: Active Supplier  
Houston, TX 77004

Invitation Date 04/16/2021  
Invitation Type Automatic  
Invitation Email(s) johndlemaster@hotmail.com

Hakimee Signs

Address 4361 Highway 6 North Participation Type: Active Supplier  
Houston, TX 77084

Classifications MBE,SBE (Primary),WBE

Invitation Date 04/16/2021  
Invitation Type Automatic  
Invitation Email(s) info@hakimeesigns.com

Halo Branded Solutions Inc.

Address 4130 DAYCO ST Participation Type: Active Supplier  
Houston, TX 77092

Invitation Date 04/16/2021  
Invitation Type Automatic  
Invitation Email(s) david.ladyga@halo.com  
Response Status Viewed  
Status Date 05/11/2021

HAMMOND & STEPHENS (A DIVISION OF PREMIER AGENDAS INC)

Address PO BOX 629 Participation Type: Active Supplier  
FREMONT, NE 68025

Classifications TAS (Primary)

Invitation Date 04/16/2021  
Invitation Type Automatic  
Invitation Email(s)

Hammond Greetings and Promotions

Address 20770 US Hwy 281 N Participation Type: Active Supplier  
San Antonio, TX 78258

Classifications SBE (Primary)

Response Status Viewed  
Status Date 05/11/2021

Harcourt Outlines (Harcourt Industries, Inc.)

Address 7765 S 175 W Participation Type: Active Supplier  
Milroy, IN 46156

Classifications WBE (Primary)

Invitation Date 04/16/2021  
Invitation Type Automatic  
Invitation Email(s) brad@harcourtoutlines.com

Harvey-Daco, Inc. (Harvey Advertising Company)

Address 1527 Sam Houston Ave. Participation Type: Active Supplier  
Huntsville, TX 77340

Classifications HUB (Primary),WBE

Invitation Date 04/16/2021  
Invitation Type Automatic  
Invitation Email(s) pkreuzburg@harvey-daco.com

HCONE International IMPEX Inc (Enoch Kabutey)

Address 103 Summit Circle Participation Type: Active Supplier  
Houston, PA 15342

Invitation Date 04/16/2021  
Invitation Type Automatic  
Invitation Email(s) edkabutey@hconecompanies.com

Healy Awards, Inc

Address N94W14431 Garwin Mace Dr Participation Type: Active Supplier  
Menomonee Falls, WI 53051

Invitation Date 04/16/2021  
Invitation Type Automatic  
Invitation Email(s) kirstin@healyawards.com

Heart Nation Inc

Address 14807 Woodland Hills Drive, #8210 Participation Type: Active Supplier  
Humble, TX 77396

Invitation Date 04/16/2021  
Invitation Type Automatic  
Invitation Email(s) heartnationinc@gmail.com

Heart to Heart Advtvertising & Awards

Address 2305 North Street Participation Type: Active Supplier  
Beaumont, TX 77702

Classifications MBE (Primary)

Invitation Date 04/16/2021  
Invitation Type Automatic  
Invitation Email(s) sales@heart2heartaward.com

Heavenly Service, LLC

Address P.O. Box 57554 Participation Type: Active Supplier  
Webster, TX 77598

Classifications MBE (Primary),WBE

Invitation Date 04/16/2021  
Invitation Type Automatic  
Invitation Email(s) mail@heavenlyservicellc.com

Hercules Poly

Address 315 Main St Participation Type: Active Supplier  
Eclectic, AL 36024

Invitation Date 04/16/2021  
Invitation Type Automatic  
Invitation Email(s) thelington@herculespoly.com



Heritage Treasures Screen Print and Embroidery (Heritage Treasures, LLC)

Address 45969 Nokes Blvd., suite #110 Participation Type: Active Supplier  
Sterling, VA 20166

Classifications MBE,SBE (Primary),WBE

Invitation Date 04/16/2021  
Invitation Type Automatic  
Invitation Email(s) Gleaton47@aol.com

Hill Country Screen Printing & Embroidery

Address 1406 East Main Street STE#200 Participation Type: Active Supplier  
Fredericksburg, TX 78624

Classifications MBE (Primary)

Invitation Date 04/16/2021  
Invitation Type Automatic  
Invitation Email(s) aleman.jesse32@yahoo.com

Hooper Strategies

Address 515 Davis Rd. Participation Type: Active Supplier  
Granbury, TX 76049

Invitation Date 04/16/2021  
Invitation Type Automatic  
Invitation Email(s) Louise@hooperstrategies.com Les@HooperStrategies.com

Horns Crew Trucking (Alvin Horn)

Address 107 B Cherie Ln Participation Type: Active Supplier  
Longview, TX 75604

Classifications MBE,SBE (Primary),HUB

Invitation Date 04/16/2021  
Invitation Type Automatic  
Invitation Email(s) hornscrew hornscrew@yahoo.com

Houston Astros

Address 501 Crawford Street Participation Type: Active Supplier  
Houston, TX 77002

Invitation Date 04/16/2021  
Invitation Type Automatic  
Invitation Email(s)

Houston Event Photography

Address 1711 Sedona Drive Participation Type: Active Supplier  
League City, TX 77573

Invitation Date 04/16/2021  
Invitation Type Automatic  
Invitation Email(s) info@houstoneventphotography.com

Houston Graduation Center, INC. (Herff Jones)

Address 4915 Schuler St. Participation Type: Active Supplier  
Houston, TX 77007

Invitation Date 04/16/2021  
Invitation Type Automatic  
Invitation Email(s) dalas@hjgradcenter.com

Houston Modular Installation

Address 6245 Brookhill Dr  
Houston, TX 77087 Participation Type: Active Supplier

Classifications MBE,HUB (Primary)

Invitation Date 04/16/2021  
Invitation Type Automatic  
Invitation Email(s) melinda@houstonmodular.com

Houston Printing (DFS Print LLC)

Address 1970 Cypress Creek Parkway  
Houston, TX 77090 Participation Type: Active Supplier

Classifications MBE (Primary)

Invitation Date 04/16/2021  
Invitation Type Automatic  
Invitation Email(s) rudy@houstonprinting.co

Houston Urban Debate League

Address 5535 Memorial Dr. Suite F553  
Houston, TX 77007 Participation Type: Active Supplier

Invitation Date 04/16/2021  
Invitation Type Automatic  
Invitation Email(s) eric.emerson@kinkaid.org

HSDesigns (Hector T. Siordia)

Address 2507 Harrowden Dr.  
Austin, TX 78727 Participation Type: Active Supplier

Classifications MBE,SBE (Primary),HUB

Invitation Date 04/16/2021  
Invitation Type Automatic  
Invitation Email(s) hector@hsdesigns.com

Hula Signworks

Address 27531 Blueberry Hill Dr.  
Oak Ridge North, TX 77385 Participation Type: Active Supplier

Invitation Date 04/16/2021  
Invitation Type Automatic  
Invitation Email(s) jessi@hulasignworks.com

HUSTLE T-SHIRT COMPANY (HUSTLE T-SHIRT COMPANY, LLC)

Address 7279 CROCKETT MARTIN RD  
CONROE, TX 77306 Participation Type: Active Supplier

Invitation Date 04/16/2021  
Invitation Type Automatic  
Invitation Email(s) jacob@hustletshirtcompany.com

Hype Socks, LLC

Address 8836 Commerce Loop Dr.  
Columbus, OH 43240 Participation Type: Active Supplier

Invitation Date 04/16/2021  
Invitation Type Automatic  
Invitation Email(s) ron@hypesocks.com

HYQUAL PROMOTIONS, LLC

Address 2827 N. MAIN STREET  
STAFFORD, TX 77477 Participation Type: Active Supplier

Classifications MBE,SBE (Primary),WBE

Invitation Date 04/16/2021  
Invitation Type Automatic  
Invitation Email(s) mblair@hyqual.net

I AM Transition Community Foundation, Inc.

Address 8455 Will Clayton Parkway  
Humble, TX 77338 Participation Type: Active Supplier

Classifications MBE,SBE (Primary),WBE

Invitation Date 04/16/2021  
Invitation Type Automatic  
Invitation Email(s) iamtransition@gmail.com

IC Print Signs Promo

Address 4687 Johnson St  
Argyle, TX 76226 Participation Type: Active Supplier

Invitation Date 04/16/2021  
Invitation Type Automatic  
Invitation Email(s) info@PrintSignsPromo.com

ICC Thermal Mapping and Data Analytcs (Infrared Concepts Corporation)

Address 465 South Orlando Ave  
Maitland, FL 32825 Participation Type: Active Supplier

Classifications SBE (Primary),WBE

Invitation Date 04/16/2021  
Invitation Type Automatic  
Invitation Email(s) mvitaleiccthermal@gmail.com

ICI Construction, Inc.

Address 24715 West Hardy Road, Spring, TX  
77389  
Spring, TX 77373 Participation Type: Active Supplier

Response Status Viewed  
Status Date 05/17/2021

ICS JAIL SUPPLIES, INC

Address PO BOX 21056  
Waco, TX 76702 Participation Type: Active Supplier

Classifications SBE (Primary)

Invitation Date 04/16/2021  
Invitation Type Automatic  
Invitation Email(s) bids@icswaco.com

id Screen Print, LLC

Address PO BOX 682784  
Houston, TX 77268 Participation Type: Active Supplier

Invitation Date 04/16/2021  
Invitation Type Automatic  
Invitation Email(s) design@idScreenPrint.com

Identity Plus LLC

Address 3205 Harrisburg Blvd  
Houston, TX 77003 Participation Type: Active Supplier

Classifications MBE (Primary),SBE,HUB,WBE

Invitation Date 04/16/2021  
Invitation Type Automatic  
Invitation Email(s) rachel@identityplusllc.com

Illinois

Address 100 W. Randolph  
Chicago, IL 60601 Participation Type: Active Supplier

Invitation Date 04/16/2021  
Invitation Type Manual  
Invitation Email(s)

Imprezos Pro Uniforms LLC

Address 1317 W. US Highway 83 Ste A.  
Pharr, TX 78577 Participation Type: Active Supplier

Invitation Date 04/16/2021  
Invitation Type Automatic  
Invitation Email(s) ipro@iprouniforms.com

Imprint Resources

Address 1124 Stratford  
Richardson, TX 75080 Participation Type: Active Supplier

Classifications TCP,TPA,HUB,WBE (Primary)

Invitation Date 04/16/2021  
Invitation Type Automatic  
Invitation Email(s) bids@imprintresources.com

Indiana

Address 402 W Washington St  
Indianapolis, IN 46204 Participation Type: Active Supplier

Invitation Date 04/16/2021  
Invitation Type Manual  
Invitation Email(s)

Industrial Air Tool (PSS Industrial Group Corp)

Address 513 Vermillion  
Pasadena, TX 77506 Participation Type: Active Supplier

Invitation Date 04/16/2021  
Invitation Type Automatic  
Invitation Email(s) ernie.granato@industrialairtool.com

Info Technology Supply Ltd

Address 9810 E 42nd St, Suite 240  
Tulsa, OK 74146 Participation Type: Active Supplier

Invitation Date 04/16/2021  
Invitation Type Automatic  
Invitation Email(s) kball@its-group.com

Infojini,Inc.

Address 10015 Old Columbia Rd  
Columbia, MD 21046 Participation Type: Active Supplier

Invitation Date 04/16/2021  
Invitation Type Automatic  
Invitation Email(s) statebids@infojiniconsulting.com

inkDOTS Printing Solutions

Address 15803 Tuckerton Rd  
Houston, TX 77095 Participation Type: Active Supplier

Classifications SBE (Primary)

Invitation Date 04/16/2021  
Invitation Type Automatic  
Invitation Email(s) grant@inkdots.com

InnerChange Consulting Group

Address 7158 Windwater Parkway N  
Houston, TX 77036 Participation Type: Active Supplier

Invitation Date 04/16/2021  
Invitation Type Automatic  
Invitation Email(s) KICIA@INNERCHANGELLC.NET

InnovsiteLLC

Address 2773 white oak drive  
Decatur, GA 30032 Participation Type: Active Supplier

Classifications MBE (Primary),SBE

Invitation Date 04/16/2021  
Invitation Type Automatic  
Invitation Email(s) hakim@innovsite.com

Insight Branding (Tarheel Promotions)

Address AIA Services LLC  
Chicago, IL 60677-8001 Participation Type: Active Supplier

Invitation Date 04/16/2021  
Invitation Type Automatic  
Invitation Email(s) andrea@insight-branding.com

Institute for Building Technology and Safety

Address 45207 Research Place  
VA, VA 20147 Participation Type: Active Supplier

Invitation Date 04/16/2021  
Invitation Type Automatic  
Invitation Email(s) cmiller@ibts.org

InsulFab (Concote Corporation)

Address 600 Freeport Parkway, Suite 150  
Coppell, TX 75019 Participation Type: Active Supplier

Invitation Date 04/16/2021  
Invitation Type Automatic  
Invitation Email(s) shelbyr@concote.com

Integrity Pipeline Services

Address P.O. Box 583  
Pearland, TX 77588 Participation Type: Active Supplier

Invitation Date 04/16/2021  
Invitation Type Automatic  
Invitation Email(s) candybrantley@sbcglobal.net

Interactive Robotics (Bayou City fencing Academy)

Address 4826 Braesvalley Drive  
Houston, TX 77096 Participation Type: Active Supplier

Invitation Date 04/16/2021  
Invitation Type Automatic  
Invitation Email(s) deychen@aol.com

International Corporate Apparel, Inc.

Address 2909 N El Burrito  
Tucson, AZ 85705 Participation Type: Active Supplier

Classifications SBE (Primary)

Invitation Date 04/16/2021  
Invitation Type Automatic  
Invitation Email(s) Randy\_Durfee@ica-usa.com

International Promotional Ideas Inc.

Address 1310 Louis Ave.  
Elk Grove Village , IL 60007 Participation Type: Active Supplier

Classifications SBE (Primary)

Invitation Date 04/16/2021  
Invitation Type Automatic  
Invitation Email(s) intl.ideas@sbcglobal.net

Intex United

Address 12626 W. Belfort Avenue  
Houston, TX 77099 Participation Type: Active Supplier

Classifications SBE (Primary)

Invitation Date 04/16/2021  
Invitation Type Automatic  
Invitation Email(s) Jonathan@Intexunited.com

Iowa State

Address 321 East 12th Street  
Des Moines, IA 50319 Participation Type: Active Supplier

Invitation Date 04/16/2021  
Invitation Type Manual  
Invitation Email(s)

IQ Total Source, LLC

Address 5120 Woodway Dr Suite 9024  
Houston, TX 77056 Participation Type: Active Supplier

Classifications SBE (Primary)

Invitation Date 04/16/2021  
Invitation Type Automatic  
Invitation Email(s)

IS Creative Graphics

Address 2635 Brazos Ridge Dr.  
Sugar Land, TX 77479 Participation Type: Active Supplier

Classifications MBE (Primary),SBE

Invitation Date 04/16/2021  
Invitation Type Automatic  
Invitation Email(s) iseahorn56@gmail.com

J. Harding & Co. (J W Drouin & Assoc.)

Address 424 West 19th Street  
Houston, TX 77008 Participation Type: Active Supplier

Classifications WBE (Primary)

Invitation Date 04/16/2021  
Invitation Type Automatic  
Invitation Email(s) wendy@jharding.com loyd@jharding.com

JADavis Advertising

Address 1213 Ashland  
Channelview, TX 77530 Participation Type: Active Supplier

Classifications TAS (Primary)

Invitation Date 04/16/2021  
Invitation Type Automatic  
Invitation Email(s) jay@jadavisadvertising.com

JAMYKY LLC

Address 2635 Brazos Ridge Drive  
Sugar Land, TX 77479 Participation Type: Active Supplier

Invitation Date 04/16/2021  
Invitation Type Automatic  
Invitation Email(s) iseahorn56@gmail.com

JAVACCS, LLC

Address 9473 Fm 1960 West Suite 100  
Humble, TX 77338 Participation Type: Active Supplier

Classifications MBE (Primary),SBE,WBE

Invitation Date 04/16/2021  
Invitation Type Automatic  
Invitation Email(s) johnson2va@gmail.com

Jaycee Rose Photography

Address PO Box 431  
New Waverly, TX 77358 Participation Type: Active Supplier

Classifications SBE (Primary),WBE

Invitation Date 04/16/2021  
Invitation Type Automatic  
Invitation Email(s)

JC Apparel & More, LLC

Address 11041 Shadow Creek Pkwy  
Pearland, TX 77584 Participation Type: Active Supplier

Classifications MBE,SBE (Primary),HUB,WBE

Invitation Date 04/16/2021  
Invitation Type Automatic  
Invitation Email(s) jcapparelandmore@gmail.com

Jeff's Mechanical Service

Address 123 Test avenue  
Houston, TX 77055 Participation Type: Active Supplier

Classifications HUB (Primary)

Invitation Date 04/16/2021  
Invitation Type Automatic  
Invitation Email(s) mrobles@hcde-texas.org

JERICO FOUNDATION REPAIR

Address 9430 WHITE CHAPEL  
HOUSTON, TX 77074 Participation Type: Active Supplier

Invitation Date 04/16/2021  
Invitation Type Automatic  
Invitation Email(s)

JOSTENS (Gardner Seaholm & Associates, LLC)

Address 25000 Pitkin #110 Spring, TX 77386 Participation Type: Active Supplier

Classifications SBE (Primary)

Invitation Date 04/16/2021  
Invitation Type Automatic  
Invitation Email(s) drgas@earthlink.net

Jostens Inc.

Address 21419 SAND BUNKER CIR KATY, TX 77450 Participation Type: Active Supplier

Invitation Date 04/16/2021  
Invitation Type Automatic  
Invitation Email(s) donna.magana@jostens.com bids@jostens.com collegebids@jostens.com  
Response Status Viewed  
Status Date 05/11/2021

Journeys Managing Group LLC

Address 16231 Charterstone Dr Houston, TX 77070 Participation Type: Active Supplier

Classifications MBE (Primary),SBE,HUB,WBE

Invitation Date 04/16/2021  
Invitation Type Automatic  
Invitation Email(s) admin@journeysmanaginggroup.com

Joy Professional Promotional Products, LLC

Address 49 W SUNRISE HIGHWAY FREEPORT, NY 11520 Participation Type: Active Supplier

Invitation Date 04/16/2021  
Invitation Type Automatic  
Invitation Email(s) admin@myjoypromo.com

Just Right Products DBA FW Promo

Address 5941 Posey Lane Haltom City, TX 76117 Participation Type: Active Supplier

Classifications SBE (Primary)

Invitation Date 04/16/2021  
Invitation Type Automatic  
Invitation Email(s) Bruce@fwpromo.com

Kahuna Flowers Inc. (The Kukui Nut Co)

Address 816 Parkwood Ct Mckinney, TX 75070 Participation Type: Active Supplier

Invitation Date 04/16/2021  
Invitation Type Automatic  
Invitation Email(s) robert@kahunaflowers.com

Kaleidoscope School Uniforms (KSU, LLC)

Address 2210 Dorrington St. Houston, TX 77030 Participation Type: Active Supplier

Classifications WBE (Primary)

Invitation Date 04/16/2021  
Invitation Type Automatic  
Invitation Email(s) kaleidoscopeuniform@gmail.com



KANKO (Floyd's Chores & Odd Jobs)

Address 2031 Cedar Valley  
Dallas, TX 75232 Participation Type: Active Supplier

Invitation Date 04/16/2021  
Invitation Type Automatic  
Invitation Email(s) kankobidops@gmail.com

Kansas

Address 1000 SW Jackson St  
Topeka, KS 66612 Participation Type: Active Supplier

Invitation Date 04/16/2021  
Invitation Type Manual  
Invitation Email(s)

Karsons Clothier

Address 300 n. akard #1708  
dallas, TX 75201 Participation Type: Active Supplier

Invitation Date 04/16/2021  
Invitation Type Automatic  
Invitation Email(s) ktr@karsonsdallas.com

Kids N Care

Address 4606 FM 1960 West  
Houston, TX 77069 Participation Type: Active Supplier

Invitation Date 04/16/2021  
Invitation Type Automatic  
Invitation Email(s) kidsncare2019@gmail.com

Kiln Services of North Texas

Address 319 Mockingbird Lane  
Highland Village, TX 75077 Participation Type: Active Supplier

Response Status Viewed  
Status Date 05/11/2021

Kimble Hair Studio

Address 8260 Santa Monica Blvd  
Los Angeles, CA 90035 Participation Type: Active Supplier

Classifications MBE (Primary),SBE,WBE

Invitation Date 04/16/2021  
Invitation Type Automatic  
Invitation Email(s) joannkimblebeauty@gmail.com

Kingham Dalton Wilson, Ltd.

Address 5858 Westheimer  
Houston, TX 77057 Participation Type: Active Supplier

Invitation Date 04/16/2021  
Invitation Type Automatic  
Invitation Email(s) gweidemeyer@kdwltd.com

KJH Consultant Services (Karla J. Horn)

Address 10333 Northwest Freeway  
Houston, TX 77092 Participation Type: Active Supplier

Classifications MBE,SBE (Primary),WBE

Invitation Date 04/16/2021  
Invitation Type Automatic  
Invitation Email(s) kjh@kjhconsultant.com

KLAS Products, Inc. (KLAS Products, Inc)

Address 4100 Eldorado Pkwy #100-434 Participation Type: Active Supplier  
McKinney, TX 75070

Classifications HUB,WBE (Primary)

Invitation Date 04/16/2021  
Invitation Type Automatic  
Invitation Email(s) kristin@klasproducts.com

KLD PLAYSCAPES USA (TWO WORD COMPANY LLC)

Address 22113 Majestic Woods Way Participation Type: Active Supplier  
Boca Raton, FL 33428

Invitation Date 04/16/2021  
Invitation Type Automatic  
Invitation Email(s)

KMD Hospitality (KMD Hospitality LLC)

Address 10706 Kentington Oak Drive Participation Type: Active Supplier  
Humble, TX 77396

Classifications MBE,SBE (Primary),WBE

Invitation Date 04/16/2021  
Invitation Type Automatic  
Invitation Email(s) karen@kmdhospitality.com annette@kmdhospitality.com

KMSCO Inc

Address 42A Cindy Ln Participation Type: Active Supplier  
Ocean, NJ 07712

Classifications SBE (Primary)

Invitation Date 04/16/2021  
Invitation Type Automatic  
Invitation Email(s) dave@kmscoinc.com

Konnecting the Dots

Address P O Box 23384 Participation Type: Active Supplier  
Houston, TX 77228

Classifications MBE (Primary),HUB,WBE

Invitation Date 04/16/2021  
Invitation Type Automatic  
Invitation Email(s) dotsk3@gmail.com

Krom Apparel (Jeffrey M. Oberkrom)

Address 2321 Masch Branch Rd. Ste. 307 Participation Type: Active Supplier  
Denton, TX 76207

Invitation Date 04/16/2021  
Invitation Type Automatic  
Invitation Email(s) kristi@KromApparel.com

Kronberg's Flags and Flagpoles (Associated Builders Specialties, Inc.)

Address 7106 Mapleridge Participation Type: Active Supplier  
Houston, TX 77081

Invitation Date 04/16/2021  
Invitation Type Automatic  
Invitation Email(s) ronkron@pdq.net

KS Phlebotomy School, LLC

Address 1300 B Bay Area Blvd.  
Houston, TX 77058 Participation Type: Active Supplier

Classifications MBE (Primary),SBE,WBE

Invitation Date 04/16/2021  
Invitation Type Automatic  
Invitation Email(s) ksphebotomyschool@gmail.com

Ksee Designs (Seeds and Water) (Ksee Designs)

Address 21587 Rose Mill Drive  
Kingwood, TX 77339 Participation Type: Active Supplier

Invitation Date 04/16/2021  
Invitation Type Automatic  
Invitation Email(s) kseedesigns@att.net

KWIK KOPY PRINTING (KLASSIC PRINTING LLC)

Address 1025 MERCURY DR  
HOUSTON, TX 77029 Participation Type: Active Supplier

Invitation Date 04/16/2021  
Invitation Type Automatic  
Invitation Email(s) pravin@kwikkopyhouston.com

LABSOURCE INC

Address 1260 GARNET DR  
NORTHLAKE, IL 60164 Participation Type: Active Supplier

Invitation Date 04/16/2021  
Invitation Type Automatic  
Invitation Email(s) splecki@LABSOURCE.com

Lady Liberty Flag & Flagpole (Convict Hill Floorcovering & Design Inc)

Address 6001 W. William cannon  
Austin, TX 78749 Participation Type: Active Supplier

Classifications SBE (Primary),WBE

Invitation Date 04/16/2021  
Invitation Type Automatic  
Invitation Email(s) sandra@ladylibertyflag.com

Lady Liberty Group LLC

Address 722 West Eules Blvd.  
Eules, TX 76040 Participation Type: Active Supplier

Classifications MBE,SBE,HUB (Primary),WBE

Invitation Date 04/16/2021  
Invitation Type Automatic  
Invitation Email(s) d@ladylibertygroup.com

Laksh Corporation

Address 1821 Meadow Ridge Dr  
Flower Mound, TX 75028 Participation Type: Active Supplier

Invitation Date 04/16/2021  
Invitation Type Automatic  
Invitation Email(s) naresh@lakshcorporation.com  
Response Date 05/12/2021  
Response Status Submitted  
Status Date 05/12/2021

LaserMaxx (Rafter V Enterprises, LLC)

Address 2009 FM155 Participation Type: Active Supplier  
La Grange, TX 78945

Invitation Date 04/16/2021  
Invitation Type Automatic  
Invitation Email(s) jvoigt@lasermaxxusa.com

Launch Point CDC, Inc.

Address 5807 Little York Participation Type: Active Supplier  
Houston, TX 77016

Classifications MBE (Primary),SBE,HUB,WBE

Invitation Date 04/16/2021  
Invitation Type Automatic  
Invitation Email(s) imayhorn@yahoo.com

Lavish Designs LLC

Address 831 S Broadway St Participation Type: Active Supplier  
La Porte, TX 77571-5323

Classifications MBE (Primary),SBE

Invitation Date 04/16/2021  
Invitation Type Automatic  
Invitation Email(s) lavishst@yahoo.com  
Response Status Viewed  
Status Date 05/11/2021

Lazer Custom Apparel

Address 505 Century Parkway Participation Type: Active Supplier  
Allen, TX 75013

Invitation Date 04/16/2021  
Invitation Type Automatic  
Invitation Email(s)

Learning Tools (Aurora L Hart)

Address 6932 FM 1960 Rd East Participation Type: Active Supplier  
Humble, TX 77346

Classifications TIP,SBE (Primary),WBE

Invitation Date 04/16/2021  
Invitation Type Automatic  
Invitation Email(s) learning.tools@live.com

Learning Zone (Kimco Educational Products, INC)

Address 10531 Gulfdale Participation Type: Active Supplier  
San Antonio, TX 78216

Classifications MBE,TAS (Primary),TCP

Invitation Date 04/16/2021  
Invitation Type Automatic  
Invitation Email(s) learningzoneinfo@yahoo.com hwangbrenda@ymail.com

Levy's Tutorial and Enrichment Center (Mary Baumann)

Address 4814 Burma Rd Participation Type: Active Supplier  
Houston, TX 77033

Classifications MBE (Primary),SBE,WBE

Response Date 05/04/2021  
Response Status No Bid  
Status Date 05/04/2021

Liberty Flags, Inc.

Address PO Box 55101  
Tulsa, OK 74155 Participation Type: Active Supplier

Classifications SBE (Primary),WBE

Invitation Date 04/16/2021  
Invitation Type Automatic  
Invitation Email(s) service@libertyflags.com

Liberty Office Products (Liberty Data Products, Inc)

Address 8744 Westpark  
Houston, TX 77063 Participation Type: Active Supplier

Classifications TXM,SBE

Invitation Date 04/16/2021  
Invitation Type Automatic  
Invitation Email(s) cleblanc@libertyoffice.com bfalkenstine@libertyoffice.com swiland@libertyoffice.com cansted@libertyoffice.com  
rwikerson@libertyoffice.com syoung@libertyoffice.com  
Response Date 05/18/2021  
Response Status Submitted  
Status Date 05/18/2021

Lighthouse Groups LLC

Address 11556 Philmar Lane  
Saint Louis, MO 63138-1720 Participation Type: Active Supplier

Classifications MBE (Primary),SBE

Invitation Date 04/16/2021  
Invitation Type Automatic  
Invitation Email(s) lighthousegroups@sbcglobal.net

Liquid Studio Group

Address 1407 Calle del Norte  
Laredo, TX 78041 Participation Type: Active Supplier

Invitation Date 04/16/2021  
Invitation Type Automatic  
Invitation Email(s) robert@liquidsg.com

Lloyd Schuh Co., Inc. dba LSC Promos

Address 100 Morgan Keegan Dr.  
Little Rock, AR 72202 Participation Type: Active Supplier

Classifications SBE (Primary)

Invitation Date 04/16/2021  
Invitation Type Automatic  
Invitation Email(s) aschuh@LSCpromos.com

LONE STAR FLAGS & FLAGPOLES INC.

Address P.O. Box 290  
Sugar Land, TX 77487-0290 Participation Type: Active Supplier

Invitation Date 04/16/2021  
Invitation Type Automatic  
Invitation Email(s)

Lone Star Flags & Flagpoles, Inc.

Address P.O. Box 3051  
Galveston, TX 77552 Participation Type: Active Supplier

Invitation Date 04/16/2021  
Invitation Type Automatic  
Invitation Email(s) elisabeth@lonestarflags.net

lone star uniforms

---

Address 8430 n sam houston pky west Participation Type: Active Supplier  
houston, TX 77064

Classifications MBE,HUB,WBE (Primary)

Invitation Date 04/16/2021  
Invitation Type Automatic  
Invitation Email(s) kstoelke@sbcglobal.net

Lovebundles4ever LLC

---

Address 1204 Chase Village Dr Participation Type: Active Supplier  
Jonesboro, GA 30236

Invitation Date 04/16/2021  
Invitation Type Automatic  
Invitation Email(s) Lovebundles4ever@gmail.com

Lowes Companies Inc

---

Address 1000 Lowes Blvd Participation Type: Active Supplier  
 Mooresville, NC 28117

Invitation Date 04/16/2021  
Invitation Type Automatic  
Invitation Email(s)

LP Printing ( Long Plan Printing ) (Long Plan Printing)

---

Address 3029 Crossview Participation Type: Active Supplier  
Houston, TX 77063

Classifications MBE,WBE

Invitation Date 04/16/2021  
Invitation Type Automatic  
Invitation Email(s) Walter@lpprinting.com jennifer@lpprinting.com sondra@lpprinting.com

LQI Consulting Group, LLC

---

Address 4113 Hidden View CT Participation Type: Active Supplier  
Round Rock, TX 78665

Invitation Date 04/16/2021  
Invitation Type Automatic  
Invitation Email(s)

M & M Apparel (Graff Gand Monograms & More)

---

Address 1810 Welsh Participation Type: Active Supplier  
College Station, TX 77840

Invitation Date 04/16/2021  
Invitation Type Automatic  
Invitation Email(s) office@m-mapparel.com

M&H Lighting Systems (Mapenzi Group)

---

Address 706 Maple Branch Ln Participation Type: Active Supplier  
Pearland, TX 77584

Classifications MBE (Primary)

Invitation Date 04/16/2021  
Invitation Type Automatic  
Invitation Email(s) wmartin@mhlightingsystems.com

M.E.N. (Mentoring, Educating & Nurturing) Incorporated (MEN Inc.)

Address 3033 CHIMNEY ROCK ROAD Participation Type: Active Supplier  
Houston, TX 77056

Response Date 05/15/2021  
Response Status No Bid  
Status Date 05/15/2021

macleem sports wear

Address 191 clendenny ave Participation Type: Active Supplier  
Jersey City, NJ 07304

Classifications MBE (Primary)

Invitation Date 04/16/2021  
Invitation Type Automatic  
Invitation Email(s) SALES@MACLEEM.COM

MadPen Designs

Address 12690 FM 1314 Participation Type: Active Supplier  
Conroe, TX 77302

Classifications SBE (Primary)

Invitation Date 04/16/2021  
Invitation Type Automatic  
Invitation Email(s) britney@madpendesigns.com

Magnolia Park Arts & Community

Address 16516 El Camino Real, #354 Participation Type: Active Supplier  
Houston, TX 77062

Classifications MBE,HUB (Primary)

Invitation Date 04/16/2021  
Invitation Type Automatic  
Invitation Email(s) karen@magnoliaparkarts.org

Main Stop Testing Svcs

Address 12401 S. Post Oak Rd Participation Type: Active Supplier  
Houston, TX 77045

Classifications MBE (Primary),SBE

Invitation Date 04/16/2021  
Invitation Type Automatic  
Invitation Email(s) testingsvcs@aol.com

MAINLAND SUPPLY

Address 1070 Vega Way Participation Type: Active Supplier  
San Marcos, CA 92078

Classifications WBE (Primary)

Invitation Date 04/16/2021  
Invitation Type Automatic  
Invitation Email(s) gguizon@mainlandsupply.com

MAKEDA GROUP AND ASSOCIATES

Address PO BOX 88356 Participation Type: Active Supplier  
HOUSTON, TX 77288

Classifications MBE (Primary)

Invitation Date 04/16/2021  
Invitation Type Automatic  
Invitation Email(s) DORIS@MAKEDAGRP.COM

Malor & Company Inc

Address 554 West 54th  
New York, NY 10019 Participation Type: Active Supplier

Classifications MBE (Primary),SBE

Invitation Date 04/16/2021  
Invitation Type Automatic  
Invitation Email(s) garly.b@malorcompany.com

Manning's Office Solutions (Manning's)

Address 1510 N 7th  
Beaumont, TX 77703 Participation Type: Active Supplier

Classifications HUB (Primary),WBE

Invitation Date 04/16/2021  
Invitation Type Automatic  
Invitation Email(s) galed@manningsupply.com

Marfield Corporate Stainery (Marfield, Inc.)

Address 1225 E. Crosby Rd.,  
Carrollton, TX 75006 Participation Type: Active Supplier

Classifications HGA,SBE (Primary),HUB,WBE

Invitation Date 04/16/2021  
Invitation Type Automatic  
Invitation Email(s) leeann\_packard@marfield.com

MarketExpo.com (Gerlach Inc.)

Address 926 Harbour House Dr  
Indian Rocks Beach, FL 33785 Participation Type: Active Supplier

Classifications WBE (Primary)

Invitation Date 04/16/2021  
Invitation Type Automatic  
Invitation Email(s) denise@markizzle.com

Marketing Magic International LTD

Address 1622 Cintola Lane  
League City, TX 77573 Participation Type: Active Supplier

Classifications HUB,WBE

Invitation Date 04/16/2021  
Invitation Type Automatic  
Invitation Email(s) jgarrett@marketingm.com

MARY LOUS TWIRLERS & DRILL TREAM (TERRY LYNN DAVIS)

Address 5010 CHENNAULT  
HOUSTON, TX 77033 Participation Type: Active Supplier

Classifications MBE,SBE (Primary),WBE

Invitation Date 04/16/2021  
Invitation Type Automatic  
Invitation Email(s) tldavis42@yahoo.com



Masks.com

Address PO Box 4775  
Lago Vista, TX 78645 Participation Type: Active Supplier

Classifications SBE (Primary)

Invitation Date 04/16/2021  
Invitation Type Automatic  
Invitation Email(s) bradley@masks.com

Massachusetts

Address One Ashburton Place  
Boston, MA 02108 Participation Type: Active Supplier

Invitation Date 04/16/2021  
Invitation Type Manual  
Invitation Email(s)

Master Jiu-jitsu Academy (Master Jiu-jitsu Academy LLC)

Address 12260 GULF FWY  
HOUSTON, TX 77034-4437 Participation Type: Active Supplier

Invitation Date 04/16/2021  
Invitation Type Automatic  
Invitation Email(s) grapplingzone@yahoo.com

Mata Boxing Promotions- MBP (Jason Mata)

Address 2925 W COMMERCE ST  
SAN ANTONIO, TX 78207-3719 Participation Type: Active Supplier

Classifications MBE,SBE,HUB (Primary)

Invitation Date 04/16/2021  
Invitation Type Automatic  
Invitation Email(s) jmata146@gmail.com

MAVICH

Address 525 Commerce Street  
Southlake, TX 76092 Participation Type: Active Supplier

Invitation Date 04/16/2021  
Invitation Type Automatic  
Invitation Email(s) sales@mavich.com

Max Marketing Company

Address 116 West Lewis  
Conroe, TX 77301 Participation Type: Active Supplier

Invitation Date 04/16/2021  
Invitation Type Automatic  
Invitation Email(s) dana@maxmarketingcompany.com

Mayo's Printing & Awards

Address 4920 Kelley St.  
Houston, TX 77026 Participation Type: Active Supplier

Invitation Date 04/16/2021  
Invitation Type Automatic  
Invitation Email(s) mayosprinting@sbcglobal.net

MCS Enterprises

Address 4112 Fannin  
Houston, TX 77004 Participation Type: Active Supplier

Classifications MBE,SBE (Primary)

Invitation Date 04/16/2021  
Invitation Type Automatic  
Invitation Email(s)

MECA Sportswear

Address 1120 Townline Rd  
Tomah, WI 54660 Participation Type: Active Supplier

Invitation Date 04/16/2021  
Invitation Type Automatic  
Invitation Email(s) jcram@mecasportswear.com  
Response Status Viewed  
Status Date 05/11/2021

Metromarketing Services, Inc.

Address 1518 Antoine Drive  
Houston, TX 77055 Participation Type: Active Supplier

Classifications HUB,WBE (Primary)

Invitation Date 04/16/2021  
Invitation Type Automatic  
Invitation Email(s) tara.dunn@metromkt.com

Midwest Office Furniture Inc (Midwest Office Supply)

Address 1801 Austin Street  
Wichita Falls, TX 76301 Participation Type: Active Supplier

Invitation Date 04/16/2021  
Invitation Type Automatic  
Invitation Email(s) richard.finn@mofsupply.com

Mighty Moose Screen Printing (Paramount Printing)

Address 4707 hwy 36 S #25  
Rosenberg, TX 77471 Participation Type: Active Supplier

Classifications MBE,SBE (Primary)

Invitation Date 04/16/2021  
Invitation Type Automatic  
Invitation Email(s) alex3@themighty Moose.com

MINIXMEDIA

Address 1100 HERGET AVENUE  
PORT ARTHUR, TX 77640 Participation Type: Active Supplier

Classifications HUB (Primary)

Invitation Date 04/16/2021  
Invitation Type Automatic  
Invitation Email(s) Rminix@minixmedia.com

Minnesota

Address 75 Rev Dr. Martin Luther King Jr. Blvd.  
St. Paul, MN 55155 Participation Type: Active Supplier

Invitation Date 04/16/2021  
Invitation Type Manual  
Invitation Email(s)

Minuteman Press (KERS Enterprises, L.L.C.)

Address 1602 S Friendswood Dr Participation Type: Active Supplier  
Friendswood, TX 77546

Invitation Date 04/16/2021  
Invitation Type Automatic  
Invitation Email(s) rsmithhart@minutemanpress.com

Miracle Method of Austin (Nartor Associates Inc)

Address 8906 Wall St, Suite 501 Participation Type: Active Supplier  
Austin, TX 78754

Invitation Date 04/16/2021  
Invitation Type Automatic  
Invitation Email(s) adominick@miraclemethod.com

Mirror Print Solutions

Address 3514 Pebble Way Ln Participation Type: Active Supplier  
Missouri City, TX 77459-1794

Classifications MBE (Primary),WBE  
Invitation Date 04/16/2021  
Invitation Type Automatic  
Invitation Email(s) preeta.anil@mirrorprintsolutions.com

Mississippi

Address Post Office Box 849 Participation Type: Active Supplier  
Jackson, MS 39205

Invitation Date 04/16/2021  
Invitation Type Manual  
Invitation Email(s)

Missouri

Address PO Box 809 Participation Type: Active Supplier  
Jefferson City, MO 65102

Invitation Date 04/16/2021  
Invitation Type Manual  
Invitation Email(s)

Mixxdd Marketing

Address 104 Shady Participation Type: Active Supplier  
Kenedy, TX 78119

Classifications MBE (Primary)  
Invitation Date 04/16/2021  
Invitation Type Automatic  
Invitation Email(s) gunner@mixxdd.com

ModFit Apparel

Address 114 E Main St Participation Type: Active Supplier  
Forney, TX 75126

Classifications TAS,WBE (Primary)  
Invitation Date 04/16/2021  
Invitation Type Automatic  
Invitation Email(s) bids@modfit.net

Moments Etc.

Address 15311 Paxton Landing Lane Participation Type: Active Supplier  
Cypress, TX 77433

Classifications SBE (Primary)

Invitation Date 04/16/2021  
Invitation Type Automatic  
Invitation Email(s) janetdaniels@momentsetc.com

Monarch Trophy Studio (Drago Investments LTD)

Address 2121 NW Military Hwy Participation Type: Active Supplier  
San Antonio, TX 78213

Invitation Date 04/16/2021  
Invitation Type Automatic  
Invitation Email(s)

Mondor Ltd

Address 785 Honoré-Mercier Participation Type: Active Supplier  
saint-jean-sur-Richelieu, QC Canada J2X  
3S2

Invitation Date 04/16/2021  
Invitation Type Automatic  
Invitation Email(s) yesdavid@sbcglobal.net

M-Pak, Inc.

Address 11255 Camp Bowie West Participation Type: Active Supplier  
Aledo, TX 76008

Classifications TAS,SBE (Primary),WBE

Invitation Date 04/16/2021  
Invitation Type Automatic  
Invitation Email(s) Justin@mpakpackaging.com

Mpressa (Sabre Technologies)

Address 7885 Northcourt #100 Participation Type: Active Supplier  
Houston, TX 77040

Invitation Date 04/16/2021  
Invitation Type Automatic  
Invitation Email(s) chris@marketabilityinc.com

MSC Industrial Supply (Sid Tool Co.)

Address P O Box 953635 Participation Type: Active Supplier  
St. Louis, MO 63195-3635

Invitation Date 04/16/2021  
Invitation Type Automatic  
Invitation Email(s) ralph.walton@mscdirect.com stumpm@mscdirect.com

MTM Recognition Corporation

Address PO Box 15669 Participation Type: Active Supplier  
Oklahoma City, OK 73115

Invitation Date 04/16/2021  
Invitation Type Automatic  
Invitation Email(s) mmartin@mtmrecognition.com  
Response Status Viewed  
Status Date 05/11/2021

MTS

---

Address P.O. Box 204 Participation Type: Active Supplier  
Golden, MS 38847

Invitation Date 04/16/2021  
Invitation Type Automatic  
Invitation Email(s) bonnie155@mts-safety.com

Mufasa's Pride Rites of Passage

---

Address PO Box 273396 Participation Type: Active Supplier  
Houston, TX 77277

Classifications SBE (Primary)

Invitation Date 04/16/2021  
Invitation Type Automatic  
Invitation Email(s) hondre@mufasaspride.org

Murphy Robes (Herff Jones LLC)

---

Address 1000 N Market St Participation Type: Active Supplier  
Champaign, IL 61820

Invitation Date 04/16/2021  
Invitation Type Automatic  
Invitation Email(s) kdapperson@herffjones.com

Music in Motion

---

Address 1601 E Plano Parkway, Suite 100 Participation Type: Active Supplier  
Plano, TX 75074

Classifications TIP (Primary)

Invitation Date 04/16/2021  
Invitation Type Automatic  
Invitation Email(s)

MV Corp (David Peyser Sportswear)

---

Address 88 Spence Street Participation Type: Active Supplier  
Bay shore, NY 11706

Invitation Date 04/16/2021  
Invitation Type Automatic  
Invitation Email(s) roxanne@wpmv.com

MWH PUBLIC RELATIONS

---

Address ONE RIVERWAY DRIVE Participation Type: Active Supplier  
HOUSTON, TX 77056

Classifications MBE,WBE (Primary)

Invitation Date 04/16/2021  
Invitation Type Automatic  
Invitation Email(s) MARGO@MWHPUBLICRELATIONS.COM

My Flag, USA (Monty Cazier)

---

Address 2711 BENTWOOD DRIVE Participation Type: Active Supplier  
PALESTINE, TX 75803-9590

Classifications SBE (Primary),WBE

Invitation Date 04/16/2021  
Invitation Type Automatic  
Invitation Email(s) usa@myflag.com

MYBINDING.COM (INFORMATION MANAGEMENT SERVICES)

---

Address 1800 NE 25TH AVENUE, SUITE 15 Hillsboro, OR 97124 Participation Type: Active Supplier

Invitation Date 04/16/2021  
Invitation Type Automatic  
Invitation Email(s) DUSTIN.BURCH@MYBINDING.COM

myMatrixx

---

Address 3111 W. Martin Luther King Jr Blvd Tampa, FL 33607 Participation Type: Active Supplier

Invitation Date 04/16/2021  
Invitation Type Automatic  
Invitation Email(s) lwestbrooks@mymatrixx.com

Namifiers, LLC

---

Address 280 West 900 North Springville, UT 84663 Participation Type: Active Supplier

Invitation Date 04/16/2021  
Invitation Type Automatic  
Invitation Email(s)

Namitzi Yoga (Mitzi Henderson)

---

Address 510 Richmond Ave. #119 Houston, TX 77006 Participation Type: Active Supplier

Classifications SBE,HUB (Primary),WBE

Invitation Date 04/16/2021  
Invitation Type Automatic  
Invitation Email(s) namitziyoga@gmail.com

National Recognition Products - Gulf Coast

---

Address 20830 Lake Park Trail Humble, TX 77346 Participation Type: Active Supplier

Invitation Date 04/16/2021  
Invitation Type Automatic  
Invitation Email(s) nrpgulfcoast@gmail.com

NBD Graphics Inc

---

Address 5502 1st st. Katy, TX 77493 Participation Type: Active Supplier

Classifications SBE (Primary)

Invitation Date 04/16/2021  
Invitation Type Automatic  
Invitation Email(s) nbdgraphics@sbcglobal.net

NERDY BIRDIE (ENOVATEKK)

---

Address PO BOX 7673 THE WOODLANDS, TX 77380 Participation Type: Active Supplier

Classifications HUB (Primary)

Invitation Date 04/16/2021  
Invitation Type Automatic  
Invitation Email(s) CARREDONDO@ENOVATEKK.COM

Net Results (Larry Rosenbaum)

---

Address 5500 Columbia Pike Participation Type: Active Supplier  
Arlington, VA 22204

Classifications SBE (Primary)

Invitation Date 04/16/2021  
Invitation Type Automatic  
Invitation Email(s) jelaro@aol.com

New Spectrum Educational Consultants (Civil Society Educational Consultants)

---

Address 2525 S Voss Rd Participation Type: Active Supplier  
Houston, TX 77057

Classifications MBE (Primary)

Invitation Date 04/16/2021  
Invitation Type Automatic  
Invitation Email(s) al.frazier@newspectrumec.com

New Way Printing

---

Address 4102 Sam Houston Rd. Participation Type: Active Supplier  
Willis, TX 77378

Invitation Date 04/16/2021  
Invitation Type Automatic  
Invitation Email(s) sales@newwayprinting.com

New York

---

Address 633 Third Avenue Participation Type: Active Supplier  
New York, NY 10017

Invitation Date 04/16/2021  
Invitation Type Manual  
Invitation Email(s)

Newbart Products, Inc.

---

Address 10424 Rockley Rd Participation Type: Active Supplier  
Houston, TX 77099

Invitation Date 04/16/2021  
Invitation Type Automatic  
Invitation Email(s) james@newbart.com

NEXT LEVEL GRAPHIX

---

Address 5907 BRENWOOD GLEN TRL Participation Type: Active Supplier  
KATY, TX 77449

Invitation Date 04/16/2021  
Invitation Type Automatic  
Invitation Email(s) nlgraphix@hotmail.com

Nfinity Athletic

---

Address 530 Chattahoochee Row Participation Type: Active Supplier  
Atlanta, GA 30318

Classifications SBE (Primary)

Invitation Date 04/16/2021  
Invitation Type Automatic  
Invitation Email(s) tara@nfinity.com

NH MEASURES, LLC

Address 21811 KATY FREEWAY Participation Type: Active Supplier  
KATY, TX 77450

Classifications HUB (Primary)

Invitation Date 04/16/2021  
Invitation Type Automatic  
Invitation Email(s) NHMEASURES@GMAIL.COM

Night Owls Print Shop

Address 14526 Lillja Rd Participation Type: Active Supplier  
Houston, TX 77060

Invitation Date 04/16/2021  
Invitation Type Automatic  
Invitation Email(s) eric@nightowlsprint.com

no bully here

Address 4808 FAIRMONT PARKWAY Participation Type: Active Supplier  
PASADENA, TX 77505

Classifications MBE (Primary),SBE

Invitation Date 04/16/2021  
Invitation Type Automatic  
Invitation Email(s) negrislebrum@gmail.com

NO EGO APPAREL (NO EGO INC)

Address 13112 TAMAYO DR Participation Type: Active Supplier  
AUSTIN, TX 78729

Invitation Date 04/16/2021  
Invitation Type Automatic  
Invitation Email(s) cgrant@shopnoego.com

Nomadic Strand

Address 3701 Kirby Dr Participation Type: Active Supplier  
Houston, TX 77098

Classifications SBE,WBE (Primary)

Invitation Date 04/16/2021  
Invitation Type Automatic  
Invitation Email(s) martha@arkandnomad.com

North Carolina

Address 1301 Mail Service Center Participation Type: Active Supplier  
Raleigh, NC 27699

Invitation Date 04/16/2021  
Invitation Type Manual  
Invitation Email(s)

North Houston Athletics

Address 33318 Coe Ln Participation Type: Active Supplier  
Magnolia, TX 77354

Invitation Date 04/16/2021  
Invitation Type Automatic  
Invitation Email(s) marjorie@nhathletics.com aaron@nhathletics.com  
Response Date 05/04/2021  
Response Status Submitted  
Status Date 05/04/2021



North Star Screen Printing

Address 2978 Congressman Lane Participation Type: Active Supplier  
Dallas, TX 75220

Classifications WBE (Primary)

Invitation Date 04/16/2021  
Invitation Type Automatic  
Invitation Email(s) cheri@dallasscreen.com

NS BRANDING LLC

Address 3927 windmill st. Participation Type: Active Supplier  
sugar land, TX 77479

Invitation Date 04/16/2021  
Invitation Type Automatic  
Invitation Email(s) president@nsbranding.com

NT Printing Services

Address 505 N. Sam Houson Pkwy #425 Participation Type: Active Supplier  
Houston, TX 77060

Classifications MBE,SBE (Primary),WBE

Invitation Date 04/16/2021  
Invitation Type Automatic  
Invitation Email(s) twania@ntprintingandpromo.org

NU HEIGHTS

Address 13415 Raven Roost Drive Participation Type: Active Supplier  
Cypress, TX 77429

Classifications MBE (Primary),SBE

Invitation Date 04/16/2021  
Invitation Type Automatic  
Invitation Email(s) jagreen25@comcast.net

Oak Hall Cap & Gown

Address 840 Union Street Participation Type: Active Supplier  
Salem, VA 24153

Invitation Date 04/16/2021  
Invitation Type Automatic  
Invitation Email(s) bids@oakhalli.com

Oasis Apparel (Dioz Group)

Address 5000 Lankershim blvd. Participation Type: Active Supplier  
North Hollywood, CA 91601

Classifications USC (Primary)

Invitation Date 04/16/2021  
Invitation Type Automatic  
Invitation Email(s)

OEM Supplies LLC

Address PO Box 166051 Participation Type: Active Supplier  
Irving, TX 75061

Classifications MBE (Primary),HUB

Invitation Date 04/16/2021  
Invitation Type Automatic  
Invitation Email(s) daron\_walton@oemsupplies.com

OFFICE DEPOT

Address 6225 WEST BY NORTHWEST BLVD Participation Type: Active Supplier  
HOUSTON, TX 77040

Classifications TCP (Primary),TXM,USC

Invitation Date 04/16/2021  
Invitation Type Automatic  
Invitation Email(s) nidhi.bhagat@officedepot.com brooke.fisher@officedepot.com

OFFICE WORKS (KBC OFFICE WORKS, LLC)

Address 6011 West Orem Drive Participation Type: Active Supplier  
Houston, TX 77085

Classifications MBE,SBE (Primary)

Invitation Date 04/16/2021  
Invitation Type Automatic  
Invitation Email(s) lhall@ourofficeworks.com ron.bailey@thekbc.com

O'Hanlon, Demerath & Castillo

Address 808 West Ave Participation Type: Active Supplier  
Austin, TX 78701

Invitation Date 04/16/2021  
Invitation Type Automatic  
Invitation Email(s) bcastillo@808west.com

Ohio State

Address 4200 Surface Road Participation Type: Active Supplier  
Columbus, OH 43228

Invitation Date 04/16/2021  
Invitation Type Manual  
Invitation Email(s)

One More Round Inc

Address 10702 Ballantine Street Participation Type: Active Supplier  
Houston, TX 77075

Invitation Date 04/16/2021  
Invitation Type Automatic  
Invitation Email(s) 1moreroundinc@gmail.com  
Response Date 04/30/2021  
Response Status No Bid  
Status Date 04/30/2021

Online Stores, Inc

Address 1000 Westinghouse Drive Suite 1 Participation Type: Active Supplier  
New Stanton, PA 15672

Invitation Date 04/16/2021  
Invitation Type Automatic  
Invitation Email(s) clay.carroll@onlinestores.com

Opal R. Helm, LLC

Address 718 Peddie St Participation Type: Active Supplier  
Houston, TX 77008

Classifications MBE (Primary),SBE,WBE

Invitation Date 04/16/2021  
Invitation Type Automatic  
Invitation Email(s) jennifer@halseyandhelm.com

Optimum Nurse Aid Skills Training

Address 4423 Stallion Brook Lane Participation Type: Active Supplier  
Spring, TX 77388

Classifications MBE (Primary),SBE,HUB,WBE

Invitation Date 04/16/2021  
Invitation Type Automatic  
Invitation Email(s) s5463director@gmail.com

Oregon

Address 350 Winter St Participation Type: Active Supplier  
Salem, OR 97301

Invitation Date 04/16/2021  
Invitation Type Manual  
Invitation Email(s)

Oriental Trading Company, Inc

Address PO Box 2308 Participation Type: Active Supplier  
Omaha, NE 68103-2308

Classifications TAS (Primary)

Invitation Date 04/16/2021  
Invitation Type Automatic  
Invitation Email(s) npsbids@oriental.com jcarlsen@oriental.com

Original Impressions

Address 7702 Tussendo Dr Participation Type: Active Supplier  
Houston, TX 77083

Classifications MBE (Primary)

Invitation Date 04/16/2021  
Invitation Type Automatic  
Invitation Email(s) oiprinting@yahoo.com

ORR TEXTILE COMPANY

Address 4777 BLALOCK Participation Type: Active Supplier  
HOUSTON, TX 77041

Classifications HUB (Primary),WBE

Invitation Date 04/16/2021  
Invitation Type Automatic  
Invitation Email(s) TAMMY@ORRTEXTILE.COM

Ottomatic Threads

Address 9940 US-380 Participation Type: Active Supplier  
Cross Roads, TX 76227

Classifications WBE (Primary)

Response Status Viewed  
Status Date 05/18/2021

Pacific Coast Flag

Address 2685 Land Park Dr. Participation Type: Active Supplier  
Sacramento, CA 95818

Invitation Date 04/16/2021  
Invitation Type Automatic  
Invitation Email(s) jgirardo@msn.com

Paddle Tramps Mfg. Co./AwardPlace

Address 1317 University Avenue Participation Type: Active Supplier  
Lubbock, TX 79401

Classifications TIP (Primary)

Invitation Date 04/16/2021  
Invitation Type Automatic  
Invitation Email(s) kyle@paddletramps.com

Page International Communications

Address 2748 Bingle Road Participation Type: Active Supplier  
Houston, TX 77055

Invitation Date 04/16/2021  
Invitation Type Automatic  
Invitation Email(s) mthomas@page-intl.com

Palos Sports, Inc

Address 11711 S. Austin Avenue Participation Type: Active Supplier  
Alsip, IL 60803

Invitation Date 04/16/2021  
Invitation Type Automatic  
Invitation Email(s) agallagher@palosports.com

PARADISE AIR (Luck & Logic Inc.)

Address 351 Columbia Memorial Pkwy Participation Type: Active Supplier  
Kemah, TX 77565

Classifications SBE (Primary),WBE

Invitation Date 04/16/2021  
Invitation Type Automatic  
Invitation Email(s) paradiseairkemah@gmail.com

PAUL J. COSELLI, ATTORNEY AT LAW

Address 5311 HUISACHE Participation Type: Active Supplier  
BELLAIRE, TX 77401

Invitation Date 04/16/2021  
Invitation Type Automatic  
Invitation Email(s) pjclawyer@aol.com

Paul P. Brice dba The Graphics Factory

Address 17902 Elk Valley Circle Participation Type: Active Supplier  
Houston, TX 77090

Invitation Date 04/16/2021  
Invitation Type Automatic  
Invitation Email(s) gfactory@comcast.net

Pennsylvania

Address 508 Main Capitol Building Participation Type: Active Supplier  
Harrisburg, PA 17120

Invitation Date 04/16/2021  
Invitation Type Manual  
Invitation Email(s)

PepsiCo Foodservice

Address 522 Savannah Springs Way Participation Type: Active Supplier  
Spring, TX 77373-4971

Invitation Date 04/16/2021  
Invitation Type Automatic  
Invitation Email(s) ruben.rodriquez@pepsico.com

Performing Arts Supply Co.

Address 6115 Milwee St.  
Houston, TX 77092 Participation Type: Active Supplier

Classifications SBE (Primary),WBE

Invitation Date 04/16/2021  
Invitation Type Automatic  
Invitation Email(s) Victoria@performingartssupply.com

PGA International, Inc. (Chris Gentile)

Address 11504 Craighead Dr.  
Houston, TX 77025 Participation Type: Active Supplier

Invitation Date 04/16/2021  
Invitation Type Automatic  
Invitation Email(s) chris.gentile@me.com

Pheido Advertising

Address 8439 Lake Crystal Dr.  
Houston, TX 77095 Participation Type: Active Supplier

Invitation Date 04/16/2021  
Invitation Type Automatic  
Invitation Email(s) pheidoadv@att.net

PhotoBallGuy.com (Saf Enterprises LLC)

Address 2113 Port Av.  
Las Vegas, NV 89106 Participation Type: Active Supplier

Invitation Date 04/16/2021  
Invitation Type Automatic  
Invitation Email(s) rick@photoballguy.com

Photographs by Jim / Eagle Ford Signs

Address 1013 C Street  
Floresville, TX 78114 Participation Type: Active Supplier

Invitation Date 04/16/2021  
Invitation Type Automatic  
Invitation Email(s) photographsbyjim@yahoo.com

Pixels Custom Printing

Address 21142 Birchbank Lane  
katy, TX 77449 Participation Type: Active Supplier

Invitation Date 04/16/2021  
Invitation Type Automatic  
Invitation Email(s)

Popular Embroidery Designs

Address 706 B.Curtis  
Pasadena, TX 77502 Participation Type: Active Supplier

Classifications MBE (Primary)

Invitation Date 04/16/2021  
Invitation Type Automatic  
Invitation Email(s) Victor-ped@sbcglobal.net

Positive Promotions

---

Address PO BOX 11537 Participation Type: Active Supplier  
Newark, NJ 07101-4537

Classifications TAS (Primary),TCP

Invitation Date 04/16/2021  
Invitation Type Automatic  
Invitation Email(s) bids@positivepromotions.com  
Response Status Unsubmitted  
Status Date 05/11/2021

---

Post Oak Graphics (Gulf Interstate Engineering dba Post Oak Graphics)

Address 16010 Barkers Point Lane Participation Type: Active Supplier  
Houston, TX 77079

Invitation Date 04/16/2021  
Invitation Type Automatic  
Invitation Email(s) ccox@gie.com

---

Postal Products Unlimited (International Commerce & Marketing Inc.)

Address 500 W. Oklahoma Ave. Participation Type: Active Supplier  
Milwaukee, WI 53207-2649

Classifications SBE (Primary)

Invitation Date 04/16/2021  
Invitation Type Automatic  
Invitation Email(s) joelh@postalproducts.com

---

PREMIER & COMPANIES

Address 237 WEST 35TH STREET Participation Type: Active Supplier  
NEW YORK, NY 10001

Classifications SBE (Primary)

Invitation Date 04/16/2021  
Invitation Type Automatic  
Invitation Email(s) hmelenendez@premierandco.com

---

Premier Heritage 105

Address 7202 Barker Cypress Rd Participation Type: Active Supplier  
Cypress, TX 77433

Invitation Date 04/16/2021  
Invitation Type Automatic  
Invitation Email(s) soulstclair@gmail.com

---

Preschool Express Learning Academy

Address 1502 First St Participation Type: Active Supplier  
Humble, TX 77338

Classifications MBE (Primary),WBE

Invitation Date 04/16/2021  
Invitation Type Automatic  
Invitation Email(s) miss.brittany2006@yahoo.com

---

Presidential Staffing Solutions

Address 7202 Glen Ellen Bay Participation Type: Active Supplier  
San Antonio, TX 78244

Invitation Date 04/16/2021  
Invitation Type Automatic  
Invitation Email(s) m.nicole@presidentialstaffing.com

Prestigious Sports Outfitters (Rogers)

Address 6308 Saint Michael Drive Participation Type: Active Supplier  
McKinney, TX 75072

Invitation Date 04/16/2021  
Invitation Type Automatic  
Invitation Email(s) trogers@prestigioussportsoutfitters.com

Prevention & Treatment Resource Press (Education Specialty Publishing, LLC)

Address same as corporate Participation Type: Active Supplier  
Metairie, LA 70009-6986

Classifications MBE,SBE (Primary),WBE

Invitation Date 04/16/2021  
Invitation Type Automatic  
Invitation Email(s) elizabeth@espublish.com

Prime Central Store (Waretrack, Inc.)

Address 6229 Theall Road Participation Type: Active Supplier  
HOUSTON, TX 77066

Invitation Date 04/16/2021  
Invitation Type Automatic  
Invitation Email(s) gms@medisouth.com

Prime Sanitizing

Address 8616 Irwin Ct. Participation Type: Active Supplier  
Mckinney, TX 75072

Classifications MBE (Primary),SBE

Invitation Date 04/16/2021  
Invitation Type Automatic  
Invitation Email(s) primesanitizing@gmail.com

Principle Information Technology

Address 9301 Southwest fwy, Suite 475 Participation Type: Active Supplier  
Houston, TX 77074

Classifications MBE,DIR,SBE (Primary),HUB

Invitation Date 04/16/2021  
Invitation Type Automatic  
Invitation Email(s) reddy@principleinfotech.com

Print Package Postal (Incept LLC)

Address 5403 FM 1488 Rd STE B6 Participation Type: Active Supplier  
Magnolia, TX 77354

Classifications SBE (Primary)

Invitation Date 04/16/2021  
Invitation Type Automatic  
Invitation Email(s) Grey@PrintPackagePostal.com

Printed Promotionals

Address po box 6241 Participation Type: Active Supplier  
corpus christi, TX 78466

Classifications HUB (Primary)

Invitation Date 04/16/2021  
Invitation Type Automatic  
Invitation Email(s) info@printedpromotionals.com

Printing Communications

Address 5601 Central Crest  
Houston, TX 77092 Participation Type: Active Supplier

Classifications SBE (Primary)

Invitation Date 04/16/2021  
Invitation Type Automatic  
Invitation Email(s) pci@print-comm.com

Printworks (Printworks LLC)

Address 10140 SW Allen Blvd  
Beaverton, OR 97005 Participation Type: Active Supplier

Invitation Date 04/16/2021  
Invitation Type Automatic  
Invitation Email(s) brian@apmprintworks.com

PriorityHealthSupplies.com

Address 245 saw mill river rd  
hawthorne, NY 10532 Participation Type: Active Supplier

Classifications SBE (Primary)

Invitation Date 04/16/2021  
Invitation Type Automatic  
Invitation Email(s) support@PriorityHealthSupplies.com

Pro Player Sports

Address 1710 100Th PL SE STE C  
Everett, WA 98208 Participation Type: Active Supplier

Invitation Date 04/16/2021  
Invitation Type Automatic  
Invitation Email(s) reed@proplayersupply.com

Productive Ventures

Address 3326 Legends Mist Dr  
Spring, TX 77386 Participation Type: Active Supplier

Invitation Date 04/16/2021  
Invitation Type Automatic  
Invitation Email(s) dundrahollins@yahoo.com

Proforma Angelini & Associates (Angelini & Associates LLC)

Address 12603 Banchester Ct  
Houston, TX 77070 Participation Type: Active Supplier

Classifications SBE (Primary),WBE

Invitation Date 04/16/2021  
Invitation Type Automatic  
Invitation Email(s) brenda.angelini@proforma.com

Proforma Image Marketing

Address 10207 Ivy Field Ct.  
Houston, TX 77070 Participation Type: Active Supplier

Invitation Date 04/16/2021  
Invitation Type Automatic  
Invitation Email(s) kent.bradbury@proforma.com



Proforma Media & Print Solutions (Martin Media & Print Solutions, LLC)

Address P.O Box 640814 Participation Type: Active Supplier  
Cincinnati, OH 45264-0814

Invitation Date 04/16/2021  
Invitation Type Automatic  
Invitation Email(s) service.mpsolutions@proforma.com

Proforma MVP Marketing

Address 2211 Lashley Ct. Participation Type: Active Supplier  
Katy, TX 77450

Invitation Date 04/16/2021  
Invitation Type Automatic  
Invitation Email(s) holly.spillers@proforma.com

PROGRESSIVE PRODUCTS INC

Address 3305 AIRPORT CIRCLE Participation Type: Active Supplier  
PITTSBURG, KS 66762

Invitation Date 04/16/2021  
Invitation Type Automatic  
Invitation Email(s) jhess@progressiveproductsinc.com

Project:Promotions

Address 6140 Hwy 6 Participation Type: Active Supplier  
Missouri City, TX 77459

Classifications HUB,WBE (Primary)

Invitation Date 04/16/2021  
Invitation Type Automatic  
Invitation Email(s) steely@projectpromotion.com

Proline Supply Company

Address 6711-A Bingle Rd Participation Type: Active Supplier  
Houston, TX 77092

Invitation Date 04/16/2021  
Invitation Type Automatic  
Invitation Email(s) dhajduk@prolinesupply.cc

Promo Entertainment Group

Address 1911 Participation Type: Active Supplier  
Grayson, GA 30017

Invitation Date 04/16/2021  
Invitation Type Automatic  
Invitation Email(s) melanie@promoentertainmentgroup.com  
Response Status Unsubmitted  
Status Date 05/18/2021

Promo Solutions

Address 11104 Windjammer Dr Participation Type: Active Supplier  
Frisco, TX 75034

Classifications HUB,WBE (Primary)

Invitation Date 04/16/2021  
Invitation Type Automatic  
Invitation Email(s) stacy.nwpromo@att.net  
Response Status Unsubmitted  
Status Date 05/18/2021

Promos On-Time

Address 210 East 39th Street  
New York, NY 10016 Participation Type: Active Supplier

Invitation Date 04/16/2021  
Invitation Type Automatic  
Invitation Email(s) michael@promosontime.com

Promotion and Beyond Inc.

Address 18445 Amistad St.  
FOUNTAIN VALLEY, CA 92708 Participation Type: Active Supplier

Classifications SBE (Primary)

Invitation Date 04/16/2021  
Invitation Type Automatic  
Invitation Email(s) info@promotionandbeyond.com

PROMOTIONAL DESIGNS INC.

Address 8150 Brookriver Drive  
Dallas, TX 75247 Participation Type: Active Supplier

Classifications WBE (Primary)

Invitation Date 04/16/2021  
Invitation Type Automatic  
Invitation Email(s) brian@promotionaldesigns.com

ProSport Logistics

Address 3806 Kelley Ave. Suite A  
Springdale, AR 72762 Participation Type: Active Supplier

Invitation Date 04/16/2021  
Invitation Type Automatic  
Invitation Email(s)

Pro-Tuff Decals

Address 7505 Eastgate Alley  
Crystal Lake, IL 60014 Participation Type: Active Supplier

Invitation Date 04/16/2021  
Invitation Type Automatic  
Invitation Email(s) staff@protuffdecals.com

Providence Office Products LLC

Address 16753  
Conroe, TX 77385 Participation Type: Active Supplier

Invitation Date 04/16/2021  
Invitation Type Automatic  
Invitation Email(s) admin@providenceofficeproducts.com

PuckettPro (PuckettPro Inc)

Address 3460 Bluebonnet Circle  
TX, TX 76109 Participation Type: Active Supplier

Invitation Date 04/16/2021  
Invitation Type Automatic  
Invitation Email(s) dan@puckettpro.com

Purple Pear Promotional Products

Address PO Box 19788  
Sugar Land, TX 77496 Participation Type: Active Supplier

Classifications HUB,WBE (Primary)

Invitation Date 04/16/2021  
Invitation Type Automatic  
Invitation Email(s) amber@purplepearpromos.com

Push Productions (Push Design Firm, LLC)

Address 23802 FM 2978 Rd  
Tomball, TX 77375 Participation Type: Active Supplier

Invitation Date 04/16/2021  
Invitation Type Automatic  
Invitation Email(s) bridget@push-productions.com

PYRAMID SCHOOL PRODUCTS (PYRAMID PAPER COMPANY)

Address 6510 N. 54TH ST.  
TAMPA, FL 33610-1908 Participation Type: Active Supplier

Classifications TAS,TCP,TIP,TXM,SBE (Primary)

Invitation Date 04/16/2021  
Invitation Type Automatic  
Invitation Email(s) BIDDEPT@PYRAMIDSP.COM

Quick Prints Inc

Address 211 Atlantic st  
Central Islip, NY 11722 Participation Type: Active Supplier

Classifications MBE (Primary),WBE

Invitation Date 04/16/2021  
Invitation Type Automatic  
Invitation Email(s) quickprintsinc@gmail.com

QUILL CORPORATION

Address 100 SCHELTER ROAD  
LINCOLNSHIRE, IL 60069 Participation Type: Active Supplier

Classifications TCP (Primary)

Invitation Date 04/16/2021  
Invitation Type Automatic  
Invitation Email(s)

Quinn Flags

Address 316 Broadway  
Hanover, PA 17331 Participation Type: Active Supplier

Classifications SBE (Primary)

Invitation Date 04/16/2021  
Invitation Type Automatic  
Invitation Email(s) info@quinnflags.com

Quintero Enterprises (Zoom Technologies LLC)

Address 6615 Traffic Avenue  
Ridgewood, NY 11385 Participation Type: Active Supplier

Classifications MBE (Primary),SBE

Invitation Date 04/16/2021  
Invitation Type Automatic  
Invitation Email(s) andrew@vaxsource.com

R & K Apparel (R & K Imports, Inc.)

Address 450 Cloverleaf Drive Participation Type: Active Supplier  
Baldwin Park, CA 91706

Classifications MBE (Primary),WBE

Invitation Date 04/16/2021  
Invitation Type Automatic  
Invitation Email(s) pauline@rkapparel.com yesdavid@sbcglobal.net

R Jones Events

Address 21811 Mileham Lane Participation Type: Active Supplier  
Spring, TX 77388

Classifications MBE (Primary),SBE,WBE

Invitation Date 04/16/2021  
Invitation Type Automatic  
Invitation Email(s) rjones3341@gmail.com

R&H Supply Inc (MEP R&H Inc)

Address 5390 Greens Rd Participation Type: Active Supplier  
Houston, TX 77032

Invitation Date 04/16/2021  
Invitation Type Automatic  
Invitation Email(s) jeff.zeller@randhsupply.com

R&R Material Supply Co., Inc

Address 9362 Wallisville Rd Suite 120 Participation Type: Active Supplier  
Houston, TX 77013

Classifications SBE (Primary)

Invitation Date 04/16/2021  
Invitation Type Automatic  
Invitation Email(s) rrmaterialsupply@pdq.net

R3 ROBOTICS, LLC

Address 2305 LEDGEROCK RD Participation Type: Active Supplier  
WIMBERLEY, TX 78676

Classifications SBE (Primary)

Invitation Date 04/16/2021  
Invitation Type Automatic  
Invitation Email(s) jarret.new@r3robotics.com

Radius Design Works, LLC

Address P.O. Box 54481 Participation Type: Active Supplier  
Cincinnati, OH 45254

Invitation Date 04/16/2021  
Invitation Type Automatic  
Invitation Email(s) c\_berry@radiusdesignworks.com

Rain Ponchos Plus, LLC

Address P.O. 394 Participation Type: Active Supplier  
Keller, TX 76244

Classifications TAS,SBE (Primary),WBE

Invitation Date 04/16/2021  
Invitation Type Automatic  
Invitation Email(s) kim@rainponchosinc.com

Ramos & Harrison

Address 224 N Mesquite St  
Corpus Christi, TX 78401 Participation Type: Active Supplier

Invitation Date 04/16/2021  
Invitation Type Automatic  
Invitation Email(s) jrworksts@gmail.com

Raye Limited Inc

Address 4393 Park Vicente  
Calabasas, CA 91302 Participation Type: Active Supplier

Classifications SBE (Primary),WBE

Invitation Date 04/16/2021  
Invitation Type Automatic  
Invitation Email(s) bids@rayeltd.com

Rebel Athletic Inc.

Address 2554 Tarpley Road  
Carrollton, TX 75006 Participation Type: Active Supplier

Classifications MBE,TCP,TIP,USC,HUB,WBE (Primary)

Invitation Date 04/16/2021  
Invitation Type Automatic  
Invitation Email(s) jamila@rebelathletic.com

Recreation Equipment Company

Address 733 Loma Doble  
Spring Branch, TX 78070 Participation Type: Active Supplier

Invitation Date 04/16/2021  
Invitation Type Automatic  
Invitation Email(s)

Red Cloud LLC

Address 1600 Sawtelle Blvd Ste 108  
LOS ANGELES, CA 90025 Participation Type: Active Supplier

Classifications WBE (Primary)

Response Status Viewed  
Status Date 05/13/2021

Redline Print LLC

Address 2031 Anders Lane suite B  
Kemah, TX 77565 Participation Type: Active Supplier

Classifications SBE (Primary),HUB

Invitation Date 04/16/2021  
Invitation Type Automatic  
Invitation Email(s) info@redline-print.com

REDSMITH GRAPHIC SOLUTIONS

Address 435 Isom Rd  
San Antonio, TX 78216 Participation Type: Active Supplier

Classifications SBE (Primary)

Invitation Date 04/16/2021  
Invitation Type Automatic  
Invitation Email(s) hannah@redsmithgs.com

Refrigeration Gaskets of Texas

---

Address 729 W 22nd Street Participation Type: Active Supplier  
Houston, TX 77008

Invitation Date 04/16/2021  
Invitation Type Automatic  
Invitation Email(s) sales@refrigerationgaskets.com

Refrigeration Technologies, LLC

---

Address 1055 South Hanover St. Participation Type: Active Supplier  
Pottstown, PA 19465

Classifications SBE (Primary)

Response Date 05/06/2021  
Response Status No Bid  
Status Date 05/06/2021

Regency Office Products

---

Address 5151 Belt Line Road Participation Type: Active Supplier  
Dallas, TX 75254

Invitation Date 04/16/2021  
Invitation Type Automatic  
Invitation Email(s) jslade@regencyop.com

Re-Gifting Memories, LLC

---

Address 11414 Little Orchard Ct Participation Type: Active Supplier  
Tomball, TX 77377

Invitation Date 04/16/2021  
Invitation Type Automatic  
Invitation Email(s) Regiftingmemories@gmail.com

Reliable R&R Training Services

---

Address 8920 Rosecliff Drive Participation Type: Active Supplier  
Dallas, TX 75217

Classifications MBE (Primary),WBE

Invitation Date 04/16/2021  
Invitation Type Automatic  
Invitation Email(s) plainenglishtraining@yahoo.com

Reliant Business Products, Inc.

---

Address 10641 Haddington Drive Participation Type: Active Supplier  
Houston, TX 77043

Classifications MBE (Primary),SBE,HUB

Invitation Date 04/16/2021  
Invitation Type Automatic  
Invitation Email(s) deidre@rbp.com dkeller@rbp.com

Results Advertising

---

Address 130 West Fremont Road Participation Type: Active Supplier  
Lebanon, MO 65536

Invitation Date 04/16/2021  
Invitation Type Automatic  
Invitation Email(s)

Reveal Medical (Simply Sophisticate)

Address 2505 N. State Hwy 360 - Suite 400 Participation Type: Active Supplier  
Grand Prairie, TX 75050

Classifications MBE (Primary),HUB

Invitation Date 04/16/2021  
Invitation Type Automatic  
Invitation Email(s) rglenn@revealmmedicalinc.com

RGV Vocational Service,LLC

Address 2112 South Shary Rd. Suite 13 Participation Type: Active Supplier  
Mission, TX 78572

Invitation Date 04/16/2021  
Invitation Type Automatic  
Invitation Email(s) rgvvs@yahoo.com

Rhode Island

Address 1 Capitol Hill Participation Type: Active Supplier  
Providence, RI 02908

Invitation Date 04/16/2021  
Invitation Type Manual  
Invitation Email(s)

Ricochet Promo

Address 7923 Clarion Way Participation Type: Active Supplier  
Houston, TX 77040

Invitation Date 04/16/2021  
Invitation Type Automatic  
Invitation Email(s) kevin@ricochetpromo.com

RIDDELL

Address P.O. Box 71914 Participation Type: Active Supplier  
Chicago, IL 60694

Classifications TAS (Primary)

Invitation Date 04/16/2021  
Invitation Type Automatic  
Invitation Email(s) dcampbell@riddellsales.com  
Response Date 05/18/2021  
Response Status Submitted  
Status Date 05/18/2021

Rio Paper & Supply LLC

Address 1800 Mozelle Avenue Participation Type: Active Supplier  
Pharr, TX 78577

Invitation Date 04/16/2021  
Invitation Type Automatic  
Invitation Email(s) Rickcriopaper@yahoo.com

Rising Star Academy

Address 7239A West Knoll St. Participation Type: Active Supplier  
Houston, TX 77028

Invitation Date 04/16/2021  
Invitation Type Automatic  
Invitation Email(s) risingstarscholars@gmail.com

RKD Enterprise

Address 17202 Quiet Grove Ln  
Humble, TX 77346 Participation Type: Active Supplier

Classifications SBE (Primary)

Invitation Date 04/16/2021  
Invitation Type Automatic  
Invitation Email(s) dmdavis75@aol.com

Roberts & Ryan Investments, Inc.

Address 39 Broadway  
New York, NY 10006 Participation Type: Active Supplier

Classifications SBE (Primary)

Invitation Date 04/16/2021  
Invitation Type Automatic  
Invitation Email(s) jmcdonough@roberts-ryan.com

Roberts Infinite Services LLC

Address 12680 W Lake Houston Pkwy  
Houston, TX 77044 Participation Type: Active Supplier

Classifications MBE (Primary),SBE,WBE

Invitation Date 04/16/2021  
Invitation Type Automatic  
Invitation Email(s) tajuana@robertsinfiniteservices.com

Rose Costumes

Address 5800 I35N  
Denton, TX 76209 Participation Type: Active Supplier

Invitation Date 04/16/2021  
Invitation Type Automatic  
Invitation Email(s) rosecostumes@verizon.net

Royalty by Deziign LLC

Address 12302 W Dreyfus Dr  
El Mirage, AZ 85335 Participation Type: Active Supplier

Invitation Date 04/16/2021  
Invitation Type Automatic  
Invitation Email(s) tanaea.wright@royaltybydeziign.com

Rubber Stamps and More

Address 9361 Winkler Suite C  
Houston, TX 77017 Participation Type: Active Supplier

Classifications SBE (Primary)

Invitation Date 04/16/2021  
Invitation Type Automatic  
Invitation Email(s) rubberstampsandmore@gmail.com

Rukaz Kultura

Address 5503 Lawndale  
HOUSTON, TX 77023 Participation Type: Active Supplier

Classifications MBE (Primary),SBE,WBE

Invitation Date 04/16/2021  
Invitation Type Automatic  
Invitation Email(s) marissa@rukaz.work



S Corporation

Address 2037 Chestnet St Fl 1  
Phila, PA 19103 Participation Type: Active Supplier

Classifications MBE (Primary),SBE,WBE

Invitation Date 04/16/2021  
Invitation Type Automatic  
Invitation Email(s) d.banks@chazacinc.com

S&H Uniforms

Address One Aqueduct Road  
White Plains, NY 10606 Participation Type: Active Supplier

Invitation Date 04/16/2021  
Invitation Type Automatic  
Invitation Email(s) dberkowitz@shuniforms.com

Safeguard (Texas Premier Safeguard, Inc)

Address 301 Wells Fargo Drive  
Houston, TX 77090 Participation Type: Active Supplier

Invitation Date 04/16/2021  
Invitation Type Automatic  
Invitation Email(s) mike@txpsg.com

Safety Supply Inc

Address 11827 TECH COM RD  
SAN ANTONIO, TX 78233 Participation Type: Active Supplier

Classifications TPA,TXM,SBE (Primary)

Invitation Date 04/16/2021  
Invitation Type Automatic  
Invitation Email(s)

Sage West Office Supplies (Ott Chin)

Address 1213 West Loop N  
Houston, TX 77055 Participation Type: Active Supplier

Classifications MBE,SBE (Primary),HUB

Invitation Date 04/16/2021  
Invitation Type Automatic  
Invitation Email(s) susie@sagewest.com

Saifee Signs and Graphics

Address 5829 W. Sam Houston Pkwy N.  
Houston, TX 77041 Participation Type: Active Supplier

Invitation Date 04/16/2021  
Invitation Type Automatic  
Invitation Email(s) ays@saifeesigns.net

Sala Printing Service (Thomas Wesley Sala)

Address 121 North Marlborough  
Dallas, TX 75208-5746 Participation Type: Active Supplier

Invitation Date 04/16/2021  
Invitation Type Automatic  
Invitation Email(s)

San Antonio Lighthouse for the Blind

Address 2305 Roosevelt  
San Antonio, TX 78210 Participation Type: Active Supplier

Classifications TXM (Primary)

Invitation Date 04/16/2021  
Invitation Type Automatic  
Invitation Email(s)

Santex

Address 4211 W Illinois ave ste 100  
dallas, TX 75211 Participation Type: Active Supplier

Classifications MBE (Primary)

Invitation Date 04/16/2021  
Invitation Type Automatic  
Invitation Email(s)

Scarborough Specialties, Inc

Address 10501 Indiana Ave  
Lubbock, TX 79423 Participation Type: Active Supplier

Classifications HUB (Primary),WBE

Invitation Date 04/16/2021  
Invitation Type Automatic  
Invitation Email(s) holly@scarspec.com  
Response Status Viewed  
Status Date 05/13/2021

Scardino Printing 1929, LLC

Address PO Box 720  
Tomball, TX 77377 Participation Type: Active Supplier

Classifications SBE (Primary)

Invitation Date 04/16/2021  
Invitation Type Automatic  
Invitation Email(s) zach@scardinoprinting.com

Scholastic and Sports Recognition

Address 2211 Rayford Road  
Spring, TX 77386 Participation Type: Active Supplier

Classifications SBE (Primary)

Invitation Date 04/16/2021  
Invitation Type Automatic  
Invitation Email(s)

SCHOOL DISTRICT EXCHANGE

Address PO BOX 61  
BEASLEY, TX 77417 Participation Type: Active Supplier

Invitation Date 04/16/2021  
Invitation Type Automatic  
Invitation Email(s)

School Food Service Innovations

Address 103 Chaparral Circle  
Jourdanton, TX 78026 Participation Type: Active Supplier

Invitation Date 04/16/2021  
Invitation Type Automatic  
Invitation Email(s) jennifer.chapman@sfsinnovations.com

School Specialty

Address PO Box 825640 Participation Type: Active Supplier  
Philadelphia, PA 19182-5640

Classifications TCP

Invitation Date 04/16/2021  
Invitation Type Automatic  
Invitation Email(s) bidnotices@schoolspecialty.com helen.schleis@schoolspecialty.com  
Response Date 04/19/2021  
Response Status No Bid  
Status Date 04/19/2021

School Tee Factory (Custom Sportswear, Inc.)

Address 8 Enterprise Court Participation Type: Active Supplier  
Sewell, NJ 08080

Invitation Date 04/16/2021  
Invitation Type Automatic  
Invitation Email(s) bids@schoolteefactory.com

Schoolhouse Outfitters (School Outfitters)

Address 3736 Regent Ave Participation Type: Active Supplier  
Cincinnati, OH 45212

Invitation Date 04/16/2021  
Invitation Type Automatic  
Invitation Email(s) contracts@schooloutfitters.com

SCHOOLOCKER TEACHER SUPPLY

Address 127 DOS PISTOLAS Participation Type: Active Supplier  
DEL RIO, TX 78840

Classifications MBE (Primary),HUB

Invitation Date 04/16/2021  
Invitation Type Automatic  
Invitation Email(s) info@schoollockerteachersupply.com

Schulenburg Printing and Office Supplies, Inc.

Address 705 Upton Avenue Participation Type: Active Supplier  
Schulenburg, TX 78956

Invitation Date 04/16/2021  
Invitation Type Automatic  
Invitation Email(s) jeffproske@schulenburgprinting.com

Science of Sport

Address 55 E Calle Belleza Participation Type: Active Supplier  
Tucson, AZ 85716

Invitation Date 04/16/2021  
Invitation Type Automatic  
Invitation Email(s) daren@sciencesport.org

SCORE (American Soccer Co., Inc.)

Address 726 E. Anaheim Street Participation Type: Active Supplier  
Wilmington, CA 90744

Classifications MBE,WBE (Primary)

Invitation Date 04/16/2021  
Invitation Type Automatic  
Invitation Email(s) Vicki@scoresports.com

SCORE SPORTS (American Soccer Company, Inc.)

Address 726 E. Anaheim Street  
Wilmington, CA 90744 Participation Type: Active Supplier

Classifications MBE,WBE (Primary)

Invitation Date 04/16/2021  
Invitation Type Automatic  
Invitation Email(s) Janny@scoresports.com

Scoreboard Sports, LLC

Address 509 West 2600 South  
Bountiful, UT 84010 Participation Type: Active Supplier

Invitation Date 04/16/2021  
Invitation Type Automatic  
Invitation Email(s) jrogers@scoreboardsports.com

SEFNAK TRADING INC.

Address 14823 Buckskin Bridge Ct.  
Sugar Land, TX 77498 Participation Type: Active Supplier

Classifications SBE (Primary)

Invitation Date 04/16/2021  
Invitation Type Automatic  
Invitation Email(s) dr.cuneytdemir@gmail.com

Sensei's School of Martial Arts

Address 11233 Crown Park Drive #C  
Houston, TX 77067 Participation Type: Active Supplier

Classifications MBE (Primary),WBE

Invitation Date 04/16/2021  
Invitation Type Automatic  
Invitation Email(s) arsaludares@gmail.com

Sequoia Safety Suppliers, LLC

Address 1450 W Grand Parkway  
Katy, TX 77494 Participation Type: Active Supplier

Classifications MBE (Primary),SBE,HUB

Response Status Viewed  
Status Date 05/11/2021

ServiceMaster Recovery Management (Service Environments of Texas, Inc.)

Address 801 Russell Palmer Road  
Kingwood, TX 77339 Participation Type: Active Supplier

Invitation Date 04/16/2021  
Invitation Type Automatic  
Invitation Email(s) stan@smtrs.com

Session Tax Consulting & Grant Writing (Session Tax Consulting and grant writing)

Address 10800 CLAY RD  
HOUSTON, TX 77041 Participation Type: Active Supplier

Classifications MBE (Primary),SBE

Invitation Date 04/16/2021  
Invitation Type Automatic  
Invitation Email(s) edwina.session@hccs.edu

Set U Free Enterprises

Address 8011 zimmermann dr  
houston, TX 77088 Participation Type: Active Supplier

Classifications HUB (Primary)

Invitation Date 04/16/2021  
Invitation Type Automatic  
Invitation Email(s) setufree03@gmail.com

Shadetree Mechanical Contractors

Address 3632 W Thomas Rd  
PHOENIX, AZ 85019 Participation Type: Active Supplier

Invitation Date 04/16/2021  
Invitation Type Automatic  
Invitation Email(s)

SHC Sports (SHC Holdings LLC)

Address 200 N. Walnut Street  
Cottonwood Falls, KS 66845 Participation Type: Active Supplier

Invitation Date 04/16/2021  
Invitation Type Automatic  
Invitation Email(s)

Sherra Branch

Address 12614 Silverglen Estates Dr  
Houston, TX 77014 Participation Type: Active Supplier

Classifications MBE,WBE (Primary)

Invitation Date 04/16/2021  
Invitation Type Automatic  
Invitation Email(s) sbranch36@yahoo.com

Shiffler Equipment Sales, Inc.

Address 745 South Street  
Chardon, OH 44024 Participation Type: Active Supplier

Classifications TAS (Primary),TIP,TPA

Invitation Date 04/16/2021  
Invitation Type Automatic  
Invitation Email(s) j.kumher@shifflerequip.com bids@shifflerequip.com

Shirts Caps And More (CCR Promotions, Inc.)

Address 32212 Giboney Rd  
Hempstead, TX 77445 Participation Type: Active Supplier

Classifications SBE (Primary),WBE

Invitation Date 04/16/2021  
Invitation Type Automatic  
Invitation Email(s) sherri@shirtscapsandmore.com

Sign Authority Inc.

Address 3105 Benton St.  
Garland, TX 75042 Participation Type: Active Supplier

Classifications MBE (Primary),SBE

Invitation Date 04/16/2021  
Invitation Type Automatic  
Invitation Email(s) steve@signauthority.net

Sign Champ Inc

Address PO Box 1392  
SPRING, TX 77383 Participation Type: Active Supplier

Invitation Date 04/16/2021  
Invitation Type Automatic  
Invitation Email(s) cbaillio@signchamp.com

Sign Pro

Address 2112 E. William J. Bryan Pkwy  
Bryan, TX 77802 Participation Type: Active Supplier

Invitation Date 04/16/2021  
Invitation Type Automatic  
Invitation Email(s) tony.signpro@gmail.com

SIGN SOLUTIONS, INC

Address 22650 MUESCHKE ROAD  
TOMBALL, TX 77377 Participation Type: Active Supplier

Invitation Date 04/16/2021  
Invitation Type Automatic  
Invitation Email(s) donna@signsolutions.com

Signarama Global (HWI Capital)

Address 1012 San Pedro  
San Antonio, TX 78212 Participation Type: Active Supplier

Invitation Date 04/16/2021  
Invitation Type Automatic  
Invitation Email(s) espickler@sarglobalsigns.com

Signarama H-Town (JNB, LLC)

Address 301 N Loop W  
Houston, TX 77008 Participation Type: Active Supplier

Classifications MBE (Primary),SBE,WBE

Invitation Date 04/16/2021  
Invitation Type Automatic  
Invitation Email(s) judie@signarama-htown.com

Signature Aspen Imaging LLC

Address Signature Aspen Imaging LLC  
Houston, TX 77092 Participation Type: Active Supplier

Classifications SBE (Primary)

Invitation Date 04/16/2021  
Invitation Type Automatic  
Invitation Email(s) jseiford@thinksignature.com support@signatureaspen.com

Signature Media

Address 3300 Kingswood  
Houston, TX 77092 Participation Type: Active Supplier

Classifications SBE (Primary)

Invitation Date 04/16/2021  
Invitation Type Automatic  
Invitation Email(s) jseiford@thinksignature.com

SIGNS BY TOMMORROW (Joco Ventures II)

---

Address 2835 Antoine Drive., #D Houston, TX 77092 Participation Type: Active Supplier

Invitation Date 04/16/2021  
Invitation Type Automatic  
Invitation Email(s) sales@sbthoustonouth.com

Signs of Success

---

Address 11301 Huffmeister Houston, TX 77065 Participation Type: Active Supplier

Invitation Date 04/16/2021  
Invitation Type Automatic  
Invitation Email(s) sales@signsuccess.com

Signtex Outdoor, Inc.

---

Address 1225 Alma, Suite D Tomball, TX 77375 Participation Type: Active Supplier

Classifications WBE (Primary)

Invitation Date 04/16/2021  
Invitation Type Automatic  
Invitation Email(s) darlene@signout.com

Sixcess Apparel

---

Address 1023 4th Street League City, TX 77573 Participation Type: Active Supplier

Classifications TAS,TIP,WBE (Primary)

Invitation Date 04/16/2021  
Invitation Type Automatic  
Invitation Email(s) kayla@sixcessapparel.com

Skyline Book Binding Machines & GBC Supplies (Skyline Communications)

---

Address 1040 North Dutton Santa Rosa, CA 95401 Participation Type: Active Supplier

Classifications SBE (Primary),WBE

Invitation Date 04/16/2021  
Invitation Type Automatic  
Invitation Email(s) peter@onlineskyline.com

Skyline Displays of Houston (Sabre Technologies, LP)

---

Address 7885 Northcourt Rd. Suite 100 Houston, TX 77040 Participation Type: Active Supplier

Classifications SBE (Primary)

Invitation Date 04/16/2021  
Invitation Type Automatic  
Invitation Email(s)

Smart Scholars Foundation

---

Address 3615 Flannery Ridge Lane Houston, TX 77047 Participation Type: Active Supplier

Classifications MBE (Primary),SBE,WBE

Invitation Date 04/16/2021  
Invitation Type Automatic  
Invitation Email(s) smartscholarsdirector@gmail.com

SMARTOX

---

Address 4850 Plaza Dr Participation Type: Active Supplier  
Irving, TX 75063

Invitation Date 04/16/2021  
Invitation Type Automatic  
Invitation Email(s) duffy.nabors@smartox.com

SmarTTurns, Inc. dba BookSmart Publishing

---

Address 2431 Aloma Ave Participation Type: Active Supplier  
Winter Park, FL 32792

Invitation Date 04/16/2021  
Invitation Type Automatic  
Invitation Email(s) jreyes@smartturns.com

SMC Promotions (Star MarCom Solutions, LLC)

---

Address 1918 Stone Meadows Lane Participation Type: Active Supplier  
Houston, TX 77094

Classifications WBE (Primary)

Invitation Date 04/16/2021  
Invitation Type Automatic  
Invitation Email(s) teri.burt@smcpromos.com

SmileMakers

---

Address 425 Sha Lane Participation Type: Active Supplier  
Spartanburg, SC 29307

Invitation Date 04/16/2021  
Invitation Type Automatic  
Invitation Email(s) smi.bids@smilemakers.com

SMR PROMOTIONS (GLOBAL MARKETING SOLUTIONS)

---

Address 8701 BEDFORD EULESS RD Participation Type: Active Supplier  
HURST, TX 76053

Invitation Date 04/16/2021  
Invitation Type Automatic  
Invitation Email(s) SMR@SMRPROMOTIONS.COM

Soccer 4 All

---

Address 1306 FM 1092 Ste 101 Participation Type: Active Supplier  
Missouri City, TX 77459

Classifications SBE,WBE

Invitation Date 04/16/2021  
Invitation Type Automatic  
Invitation Email(s) alex@soccer4all.com

Something New Dance

---

Address 4415 Westerdale Dr. Participation Type: Active Supplier  
Fulshear, TX 77441

Classifications MBE (Primary),SBE

Invitation Date 04/16/2021  
Invitation Type Automatic  
Invitation Email(s) somethingnewdance@gmail.com



South Carolina

---

Address Post Office Box 2825  
Columbia, SC 29211 Participation Type: Active Supplier

Invitation Date 04/16/2021  
Invitation Type Manual  
Invitation Email(s)

South Coast Printing Inc

---

Address po box 38873  
Houston, TX 77238 Participation Type: Active Supplier

Classifications MBE (Primary),SBE,HUB,WBE

Invitation Date 04/16/2021  
Invitation Type Automatic  
Invitation Email(s) Tomi@southcoastprinting.com

SOUTH TEXAS PUMP INC

---

Address PO BOX 1852  
WESLACO, TX 78599 Participation Type: Active Supplier

Invitation Date 04/16/2021  
Invitation Type Automatic  
Invitation Email(s) stpump@gmail.com

Southeast Media, Inc.

---

Address 15625 Vickery Dr. #400  
Houston, TX 77032 Participation Type: Active Supplier

Classifications SBE (Primary)

Invitation Date 04/16/2021  
Invitation Type Automatic  
Invitation Email(s)

Southwest Precision Printers (Southwest Precision Printers & Associates LP)

---

Address 1055Conrad Sauer  
Houston, TX 77043 Participation Type: Active Supplier

Invitation Date 04/16/2021  
Invitation Type Automatic  
Invitation Email(s) tcisneros@swpp.com

Southwest School & Office Supply (S.W. School Supply Inc)

---

Address 805 N Barrington Ave  
Ontario, CA 91764 Participation Type: Active Supplier

Classifications WBE (Primary)

Invitation Date 04/16/2021  
Invitation Type Automatic  
Invitation Email(s) biddesk@southwestschool.com

SP Design & Manufacturer

---

Address 1215 Se 10th St.  
Cape Coral, FL 33990 Participation Type: Active Supplier

Invitation Date 04/16/2021  
Invitation Type Automatic  
Invitation Email(s) shaneh@screenprintplus.com

Space City T-Shirts Etc. (Paul Downes)

Address 2415 Karbach Street  
Houston, TX 77092 Participation Type: Active Supplier

Classifications SBE (Primary)

Invitation Date 04/16/2021  
Invitation Type Automatic  
Invitation Email(s) sctees@sbcglobal.net

SPARKLE-dance

Address 4811 Motley Dr.  
Mesquite, TX 75150 Participation Type: Active Supplier

Invitation Date 04/16/2021  
Invitation Type Automatic  
Invitation Email(s) sales@rochellerodriguez.com

Speedpro Imaging (Terramont Partners, Inc.)

Address 25003 Pitkin Rd.  
The Woodlands, TX 77386 Participation Type: Active Supplier

Invitation Date 04/16/2021  
Invitation Type Automatic  
Invitation Email(s) mschardt@speedpro.com

Spirit Monkey, LLC

Address 20658 Stone Oak Pkwy #105  
San Antonio, TX 78258 Participation Type: Active Supplier

Invitation Date 04/16/2021  
Invitation Type Automatic  
Invitation Email(s) luis@spiritmonkey.com

Sportdecals, Inc

Address PO Box 861  
Spring Grove, IL 60081 Participation Type: Active Supplier

Invitation Date 04/16/2021  
Invitation Type Automatic  
Invitation Email(s) lvetter@sportdecals.com

Sports Venue Padding (Artistic Coverings Inc)

Address 14135 Artesia Blvd  
Cerritos, CA 90703 Participation Type: Active Supplier

Classifications SBE (Primary)

Invitation Date 04/16/2021  
Invitation Type Automatic  
Invitation Email(s) michelle@svpadding.com

Sporturf

Address 200 Howell Dr  
Dalton, GA 30721 Participation Type: Active Supplier

Invitation Date 04/16/2021  
Invitation Type Automatic  
Invitation Email(s)

Spur Employment, Inc.

Address 3414 Governors Dr. SW #220  
HUNTSVILLE, AL 35805 Participation Type: Active Supplier

Invitation Date 04/16/2021  
Invitation Type Automatic  
Invitation Email(s) rfp@spurjobs.com

**SS GRAPHICS**

Address 13529 Skinner Road Suite J Cypress, TX 77355 Participation Type: Active Supplier

Classifications SBE (Primary),WBE

Invitation Date 04/16/2021  
Invitation Type Automatic  
Invitation Email(s) jennifer@ss-graphics.com

**SSR JACKETS (CUSTOM CHENILLE EMBROIDERY, INC.)**

Address 11330 HILLGUARD RD. DALLAS, TX 75243 Participation Type: Active Supplier

Invitation Date 04/16/2021  
Invitation Type Automatic  
Invitation Email(s) purchasing@ssrjackets.com  
Response Date 04/22/2021  
Response Status No Bid  
Status Date 04/16/2021

**St. George Sign Company**

Address 5715 Green Ash Dr. Houston, TX 77081 Participation Type: Active Supplier

Invitation Date 04/16/2021  
Invitation Type Automatic  
Invitation Email(s) steve@stgeorgesignco.com

**STAR POLY BAG INC**

Address 200 Liberty ave Brooklyn, NY 11207 Participation Type: Active Supplier

Classifications SBE (Primary),WBE

Invitation Date 04/16/2021  
Invitation Type Automatic  
Invitation Email(s) biddept@starpoly.com

**Steam Kidstitude (Insight Community Resources Inc)**

Address 9800 Centre Parkway suite 870 Houston, TX 77036 Participation Type: Active Supplier

Invitation Date 04/16/2021  
Invitation Type Automatic  
Invitation Email(s) insightcommunityinc@gmail.com

**Sterling Empowerment**

Address 10522 LEITRIM WAY HOUSTON, TX 77047 Participation Type: Active Supplier

Classifications SBE (Primary)

Invitation Date 04/16/2021  
Invitation Type Automatic  
Invitation Email(s) sterling@sterlingempowerment.com

**Stiff LLC**

Address 2401 S GESSNER RD HOUSTON, TX 77063 Participation Type: Active Supplier

Classifications MBE (Primary),SBE,WBE

Invitation Date 04/16/2021  
Invitation Type Automatic  
Invitation Email(s) Niekell@stiffllc.com

StockWise Solutions

---

Address 15550 Vickery Drive Ste. #150 Participation Type: Active Supplier  
Houston, TX 77032

Classifications WBE (Primary)

Invitation Date 04/16/2021  
Invitation Type Automatic  
Invitation Email(s)

StoreSMART (Visual Horizons Inc)

---

Address 180 Metro Park Participation Type: Active Supplier  
Rochester, NY 14623

Invitation Date 04/16/2021  
Invitation Type Automatic  
Invitation Email(s) laura@storesmart.com

Straight Defined

---

Address 208 West Lincoln Avenue Participation Type: Active Supplier  
Copperas Cove, TX 76522

Invitation Date 04/16/2021  
Invitation Type Automatic  
Invitation Email(s) tamaholland@gmail.com

Strategic Partnerships, Inc.

---

Address 901 S. Mopac Expy Participation Type: Active Supplier  
Austin, TX 78746

Classifications WBE (Primary)

Invitation Date 04/16/2021  
Invitation Type Automatic  
Invitation Email(s) kyoshida@spartnerships.com

STRAUS SYSTEMS INC

---

Address 7 STRAUS COURT Participation Type: Active Supplier  
STAFFORD, TX 77477

Invitation Date 04/16/2021  
Invitation Type Automatic  
Invitation Email(s)

Strong Tower Trophies T Shirts and More (Graphic Results)

---

Address 18434 Buddy Riley Blvd Participation Type: Active Supplier  
Magnolia, TX 77354-5394

Classifications SBE,WBE (Primary)

Invitation Date 04/16/2021  
Invitation Type Automatic  
Invitation Email(s) info@strongtower.com

StrongTree Products

---

Address 421 C Street #1A Participation Type: Active Supplier  
Washougal, WA 98671

Classifications WBE (Primary)

Invitation Date 04/16/2021  
Invitation Type Automatic  
Invitation Email(s) dtorres@strongtreeproducts.com

STS Brand (STS Brand LLC)

---

Address 14027 Memorial Dr. #158 Participation Type: Active Supplier  
Houston, TX 77079

Invitation Date 04/16/2021  
Invitation Type Automatic  
Invitation Email(s) info@stsbrand.com

Studica Inc.

---

Address 2326 Lockport Rd Participation Type: Active Supplier  
Sanborn, NY 14132

Invitation Date 04/16/2021  
Invitation Type Automatic  
Invitation Email(s) jenniferl@studica.com

Successful Starters Learning Academy II

---

Address P.O. Box 111144 Participation Type: Active Supplier  
Houston, TX 77293

Classifications MBE (Primary),SBE,WBE

Invitation Date 04/16/2021  
Invitation Type Automatic  
Invitation Email(s) carlasmithford@sbcglobal.net

SUN AIRED BAG (QMS - SUN AIRED BAG)

---

Address 3645 Inglewood Avenue, Participation Type: Active Supplier  
Redondo Beach, CA 90278

Invitation Date 04/16/2021  
Invitation Type Automatic  
Invitation Email(s) majotorres@sunaired.com

Superior Text

---

Address 151 Airport Industrial Dr Participation Type: Active Supplier  
Ypsilanti, MI 48198

Classifications MBE,WBE

Invitation Date 04/16/2021  
Invitation Type Automatic  
Invitation Email(s) sales@superiortext.com

SuperViewVision (Advance Century Inc)

---

Address 114 S 6th Ave Participation Type: Active Supplier  
City of Industry, CA 91746

Classifications MBE (Primary)

Invitation Date 04/16/2021  
Invitation Type Automatic  
Invitation Email(s) tshibuya@superviewvision.com

Suplay Products

---

Address PO Box 657 Participation Type: Active Supplier  
Elma, WA 98541

Invitation Date 04/16/2021  
Invitation Type Automatic  
Invitation Email(s) holly@suplay.com

Suppliaholics

Address 1814 E Bell Rd  
Phoenix, AZ 85022-2861 Participation Type: Active Supplier

Classifications MBE (Primary),SBE,WBE

Invitation Date 04/16/2021  
Invitation Type Automatic  
Invitation Email(s) Suppliaholics@gmail.com

Supreme Fixture Company, Inc.

Address PO Box 193655  
Little Rock, AR 72219 Participation Type: Active Supplier

Invitation Date 04/16/2021  
Invitation Type Automatic  
Invitation Email(s) christena@supremefixture.com

Symonds Flags & Poles, Inc.

Address 7503 Flagstone Dr.  
Fort Worth, TX 76118 Participation Type: Active Supplier

Invitation Date 04/16/2021  
Invitation Type Automatic  
Invitation Email(s) Bea@symondsflags.us

Syntheticomp Companies

Address 2847 Colony Dr.  
Sugar Land, TX 77479 Participation Type: Active Supplier

Classifications MBE,SBE,HUB (Primary)

Invitation Date 04/16/2021  
Invitation Type Automatic  
Invitation Email(s) syntheticompcmps@gmail.com

T9 Sports

Address 36136 Hwy 100  
Los Fresnos, TX 78566 Participation Type: Active Supplier

Invitation Date 04/16/2021  
Invitation Type Automatic  
Invitation Email(s) t9sports@hotmail.com

Teacher Created Resources

Address 2903 Inks Lake Drive  
Pflugerville, TX 78660 Participation Type: Active Supplier

Classifications WBE (Primary)

Invitation Date 04/16/2021  
Invitation Type Automatic  
Invitation Email(s)

Teacher Direct (TDSA, LLC)

Address 1200 B Roberts Industrial Dr  
Birmingham, AL 35208 Participation Type: Active Supplier

Invitation Date 04/16/2021  
Invitation Type Automatic  
Invitation Email(s)

Teachers Discovery Inc. (American Eagle Company Inc.)

Address 2741 Paldan Drive Participation Type: Active Supplier  
Auburn Hills, MI 48326

Invitation Date 04/16/2021  
Invitation Type Automatic  
Invitation Email(s) help@teachersdiscovery.com  
Response Date 04/22/2021  
Response Status No Bid  
Status Date 04/22/2021

Team Express (Concourse Team Express LLC)

Address 5750 Northwest Parkway, Suite 100 Participation Type: Active Supplier  
San Antonio, TX 78249

Classifications TAS (Primary)

Invitation Date 04/16/2021  
Invitation Type Automatic  
Invitation Email(s)

Team Go Figure, LLP (Single Piece Apparel)

Address 2427 Franklin Dr. Participation Type: Active Supplier  
Mesquite, TX 75150

Invitation Date 04/16/2021  
Invitation Type Automatic  
Invitation Email(s) info@teamgofigure.com  
Response Date 05/18/2021  
Response Status No Bid  
Status Date 05/18/2021

Team Logo Inc

Address 3113 bryan ave Participation Type: Active Supplier  
Fort Worth, TX 76110

Invitation Date 04/16/2021  
Invitation Type Automatic  
Invitation Email(s) joey@teamlogo.us

TeamLeader, Inc.

Address 1023 Summer Cape Circle Participation Type: Active Supplier  
League City, TX 77573

Classifications WBE (Primary)

Invitation Date 04/16/2021  
Invitation Type Automatic  
Invitation Email(s)

TEC Sports

Address 5200 Branding Iron Court Participation Type: Active Supplier  
College Station, TX 77845

Invitation Date 04/16/2021  
Invitation Type Automatic  
Invitation Email(s) Daniel@TEC-Sales.com

Technology International, Inc.

Address 1349 South International Pkwy, Suite Participation Type: Active Supplier  
2411,  
Lake Mary, FL 32746

Classifications SBE (Primary)

Invitation Date 04/16/2021  
Invitation Type Automatic  
Invitation Email(s) tii@tii-usa.com

TeeRex Embroidery

Address 17515 Huffmeister Road Cypress, TX 77429 Participation Type: Active Supplier

Classifications MBE (Primary),SBE,WBE

Invitation Date 04/16/2021  
Invitation Type Automatic  
Invitation Email(s) Crystal@teerexembroidery.com

Tegeler Sports

Address 1656 FM 389 Brenham, TX 77833 Participation Type: Active Supplier

Classifications SBE (Primary)

Invitation Date 04/16/2021  
Invitation Type Automatic  
Invitation Email(s) ltegeler@yahoo.com

Tejas Office Products, Inc.

Address 1225 W. 20th Street Houston, TX 77008 Participation Type: Active Supplier

Classifications MBE,TXM (Primary),SBE

Invitation Date 04/16/2021  
Invitation Type Automatic  
Invitation Email(s) JeanetteC@tejasoffice.com

Texas

Address 111 East 17th Street Austin, TX 78774 Participation Type: Active Supplier

Invitation Date 04/16/2021  
Invitation Type Manual  
Invitation Email(s)

Texas 4-H Youth Foundation

Address 2147 TAMU College Station, TX 77843-2147 Participation Type: Active Supplier

Invitation Date 04/16/2021  
Invitation Type Automatic  
Invitation Email(s) david.wright@ag.tamu.edu

Texas Association of African American Chambers of Commerce (TAAACC)

Address 807 Brazos Street Austin, TX 78701 Participation Type: Active Supplier

Classifications MBE,SBE (Primary),WBE

Invitation Date 04/16/2021  
Invitation Type Automatic  
Invitation Email(s) info@taaacc.org

Texas Covers (Creative Menus&Folders LLC)

Address PO Box 12 Olden, TX 76466 Participation Type: Active Supplier

Classifications MBE,SBE,HUB (Primary)

Invitation Date 04/16/2021  
Invitation Type Automatic  
Invitation Email(s) andysherman@texascovers.com



Texas Graphic Productions

Address 33100 Highway 290 Participation Type: Active Supplier  
Hockley, TX 77447

Classifications SBE (Primary)

Invitation Date 04/16/2021  
Invitation Type Automatic  
Invitation Email(s) davidsmith@txgraphicpros.com

Texas Motion Sports LLC

Address 1198 Commerce Drive Participation Type: Active Supplier  
RICHARDSON, TX 75081

Classifications TCP,TXM,SBE,HUB (Primary),WBE

Invitation Date 04/16/2021  
Invitation Type Automatic  
Invitation Email(s) bids@texasmotionsports.com

Texas Music Festivals Enterprise, Inc

Address 216 East Business Highway 83 Participation Type: Active Supplier  
San Juan, TX 78589

Invitation Date 04/16/2021  
Invitation Type Automatic  
Invitation Email(s) angela@tmftoursandtravel.com nate.tmf@gmail.com paul@tmftoursandtravel.com  
Response Date 04/28/2021  
Response Status Submitted  
Status Date 04/28/2021

Texas Promowear (Stitch Stores, Inc)

Address 2205 FM 1960 Rd E Participation Type: Active Supplier  
Humble, TX 77338

Classifications SBE (Primary)

Invitation Date 04/16/2021  
Invitation Type Automatic  
Invitation Email(s) steve@texaspromowear.com  
Response Date 05/11/2021  
Response Status No Bid  
Status Date 05/11/2021

THE BANDMANS COMPANY

Address 3328 TOWERWOOD DRIVE Participation Type: Active Supplier  
FARMERS BRANCH, TX 75234

Invitation Date 04/16/2021  
Invitation Type Automatic  
Invitation Email(s) BANDMANS@BANDMANS.COM

The Baptiste Group LLC

Address 945 Donegal Dr Participation Type: Active Supplier  
Locust Grove, GA 30248

Invitation Date 04/16/2021  
Invitation Type Automatic  
Invitation Email(s) kevinb@thebaptistegroup.com

The Class Ring Company

Address 2403 Buddy Owens Blvd. Participation Type: Active Supplier  
McAllen, TX 78504

Classifications MBE (Primary)

Invitation Date 04/16/2021  
Invitation Type Automatic  
Invitation Email(s) jrtcr@hotmail.com

THE COLLINS GROUP

Address 1139 S BALDWIN AVE Participation Type: Active Supplier  
MARION, IN 46953

Invitation Date 04/16/2021  
Invitation Type Automatic  
Invitation Email(s) regina.todd@collinsflags.com

The Costume Closet

Address 173 Boddie Road Participation Type: Active Supplier  
Sherman, TX 75090

Invitation Date 04/16/2021  
Invitation Type Automatic  
Invitation Email(s) save@thecostumecloset.com  
Response Date 05/11/2021  
Response Status No Bid  
Status Date 05/11/2021

The Document Group, Inc.

Address 1010 Lamar St. Participation Type: Active Supplier  
Houston, TX 77002

Classifications MBE,HUB (Primary)

Invitation Date 04/16/2021  
Invitation Type Automatic  
Invitation Email(s) bcollins@thedocgrp.com

The Donatto Group

Address PO Box 321226 Participation Type: Active Supplier  
Houston, TX 77221

Classifications MBE (Primary),HUB

Invitation Date 04/16/2021  
Invitation Type Automatic  
Invitation Email(s) james@thedonattogroup.com

The Flag Store (J. Hugh Campbell Co., The Flag Store)

Address 2116 N HASKELL AVE Participation Type: Active Supplier  
DALLAS, TX 75204

Classifications MBE,SBE (Primary),WBE

Invitation Date 04/16/2021  
Invitation Type Automatic  
Invitation Email(s) FLAGS@THEFLAGSTORE.COM

The Gateway Group

Address 16435 N. Scottsdale Rd. Participation Type: Active Supplier  
Scottsdale, AZ 85254

Classifications SBE (Primary),WBE

Invitation Date 04/16/2021  
Invitation Type Automatic  
Invitation Email(s) kate@gatewayppe.com

The Heart of God Restoration Ministry

---

Address 2222 Lockwood Drive Participation Type: Active Supplier  
Houston, TX 77020

Invitation Date 04/16/2021  
Invitation Type Automatic  
Invitation Email(s) theheartofgod2015@gmail.com

The Idea Source, inc

---

Address 3315 Eula Morgan Road Participation Type: Active Supplier  
Katy, TX 77493

Classifications SBE (Primary),WBE

Invitation Date 04/16/2021  
Invitation Type Automatic  
Invitation Email(s) kelly@theideasource.com

The IRIS Companies (IRIS Ltd. Inc.)

---

Address 901 Park Road Participation Type: Active Supplier  
Fleetwood, PA 19522

Classifications WBE (Primary)

Invitation Date 04/16/2021  
Invitation Type Automatic  
Invitation Email(s) Ashleyr@irisltd.com Steeviw@irisltd.com

The J Paul Company

---

Address 2535B East State Hwy 121 Participation Type: Active Supplier  
Lewisville, TX 75056

Classifications HUB,WBE (Primary)

Invitation Date 04/16/2021  
Invitation Type Automatic  
Invitation Email(s)

The MarketinGroup, LLC

---

Address 2261 North Park Dr. Participation Type: Active Supplier  
Kingwood, TX 77339

Invitation Date 04/16/2021  
Invitation Type Automatic  
Invitation Email(s) tmg@themarketinggroup.us

The Master Teacher

---

Address PO Box 1207 Participation Type: Active Supplier  
Manhattan, KS 66505-1207

Invitation Date 04/16/2021  
Invitation Type Automatic  
Invitation Email(s) bids@masterteacher.com

The MLLES Alumnae, Inc.

---

Address 4406 Plantation Pass Dr. Participation Type: Active Supplier  
Humble, TX 77346

Invitation Date 04/16/2021  
Invitation Type Automatic  
Invitation Email(s) info@themademoiselles.org

The Moret Group

Address 1411 Broadway 8th fl. Participation Type: Active Supplier  
New York, NY 10018

Invitation Date 04/16/2021  
Invitation Type Automatic  
Invitation Email(s) elliot@moret.com

The Motivation Recognition Group LLC

Address 3903 Grand Fri Ct Participation Type: Active Supplier  
Richmond, TX 77469

Classifications SBE (Primary),WBE

Invitation Date 04/16/2021  
Invitation Type Automatic  
Invitation Email(s) gmb@mrg19.com

The National Behavioral Intervention Team Association

Address 475 Allendale Rd Suite 200 Participation Type: Active Supplier  
King of Prussia, PA 19102

Invitation Date 04/16/2021  
Invitation Type Automatic  
Invitation Email(s) Christopher.Simmons@TNGConsulting.com

The Neff Company (Neff Motivation, Inc)

Address 19902 Tidy Tips Lane Participation Type: Active Supplier  
Spring, TX 77379

Classifications TAS (Primary)

Invitation Date 04/16/2021  
Invitation Type Automatic  
Invitation Email(s)

The Ombudsmen Group

Address 213 Bridle Bnd Participation Type: Active Supplier  
Cibolo, TX 78108

Invitation Date 04/16/2021  
Invitation Type Automatic  
Invitation Email(s) fmuhammad@myombudsmen.com

The Phlebotomy Learning Center

Address 505 N. Sam Houston Pkwy. E. ste. 695 Participation Type: Active Supplier  
Houston, TX 77060

Invitation Date 04/16/2021  
Invitation Type Automatic  
Invitation Email(s) phlebotomylearningcenter@yahoo.com

The Phoenix Group (Phoenix Contracting Group)

Address 4702 Meadows Edge Lane Participation Type: Active Supplier  
Houston, TX 77084

Classifications SBE,WBE (Primary)

Invitation Date 04/16/2021  
Invitation Type Automatic  
Invitation Email(s) mac@phnxcgg.com

The Really Cool T-shirt Co.

---

Address PO BOX 694  
Manchaca, TX 78652 Participation Type: Active Supplier

Invitation Date 04/16/2021  
Invitation Type Automatic  
Invitation Email(s) accounting@reallycooltees.com

The Schoolhouse Store (The Schoolhouse Store Inc)

---

Address 707A West Davis  
Conroe, TX 77301 Participation Type: Active Supplier

Classifications TAS,WBE (Primary)

Invitation Date 04/16/2021  
Invitation Type Automatic  
Invitation Email(s) info@theschoolhousestore.com

The Sign Depot (Lozz Quatezz LLC)

---

Address 105 E INTERSTATE 2  
PHARR, TX 78577 Participation Type: Active Supplier

Classifications MBE (Primary)

Invitation Date 04/16/2021  
Invitation Type Automatic  
Invitation Email(s) sales@thesigndepot.com sal@thesigndepot.com

The Thomas Jarrms Company llc

---

Address 3524 Ruth Street  
Houston, TX 77004 Participation Type: Active Supplier

Invitation Date 04/16/2021  
Invitation Type Automatic  
Invitation Email(s) rthomas@tjcgroupp.com

The Trade Group

---

Address 1434 Patton Place  
Carrollton, TX 75007 Participation Type: Active Supplier

Classifications SBE (Primary)

Invitation Date 04/16/2021  
Invitation Type Automatic  
Invitation Email(s) dbodin@tradegroup.com

The Uniform Superstore, Inc.

---

Address PO BOX 701247  
Houston, TX 77270 Participation Type: Active Supplier

Invitation Date 04/16/2021  
Invitation Type Automatic  
Invitation Email(s) gil.coelho@uniformsuperstore.com

The Urban Circle (The Urban Circle LLC)

---

Address 7505 South Fwy  
houston, TX 77021 Participation Type: Active Supplier

Classifications MBE (Primary),TXM,HUB

Invitation Date 04/16/2021  
Invitation Type Automatic  
Invitation Email(s) info@tucllc.us

TheFireStore, TheOfficerStore, TheEMSStore (Witmer Public Safety Group, Inc)

Address 104 Independence Way Participation Type: Active Supplier  
Coatesville, PA 19320

Invitation Date 04/16/2021  
Invitation Type Automatic  
Invitation Email(s) quotes@thefirestore.com

Thomas Printworks (Thomas Reprographics, Inc)

Address 4235 Richmond Ave Participation Type: Active Supplier  
Houston, TX 77027

Invitation Date 04/16/2021  
Invitation Type Automatic  
Invitation Email(s) trevor.hansen@thomasprintworks.com rock.gremillion@thomasprintworks.com  
 tara.fisher@thomasprintworks.com

Three Tikes LLC

Address 1001 Cooper Pt Rd Participation Type: Active Supplier  
Olympia, WA 98512

Classifications MBE (Primary)  
Invitation Date 04/16/2021  
Invitation Type Automatic  
Invitation Email(s) ThreeTikes@hotmail.com

Time Solutions Inc.

Address 20407 Presley Grove Dr. Participation Type: Active Supplier  
Porter, TX 77365

Classifications SBE (Primary)  
Invitation Date 04/16/2021  
Invitation Type Automatic  
Invitation Email(s) bjdaniele@tsila.com

Timothy Project: Youth Mentoring Youth, Inc.

Address P O Box 90562 Participation Type: Active Supplier  
Houston, TX 77290

Invitation Date 04/16/2021  
Invitation Type Automatic  
Invitation Email(s) carann05@yahoo.com

Tip Top Tuxedos (Al's Formal Wear)

Address 500 Floyd Dr. Participation Type: Active Supplier  
Sioux City, IA 51102

Invitation Date 04/16/2021  
Invitation Type Automatic  
Invitation Email(s) dale.harper@tttux.com

Tipton Global Sales & Services, Inc

Address P O Box 714 Participation Type: Active Supplier  
Hurst, TX 76053

Classifications TIP,SBE (Primary)  
Invitation Date 04/16/2021  
Invitation Type Automatic  
Invitation Email(s)

Titan Signs and Graphics

Address 8815 Solon Rd  
Houston, TX 77064 Participation Type: Active Supplier

Classifications SBE (Primary)

Invitation Date 04/16/2021  
Invitation Type Automatic  
Invitation Email(s) philip@titansigns.net

TMB Screen Printing

Address 9637 Cypress Creek Parkway  
Houston, TX 77070 Participation Type: Active Supplier

Invitation Date 04/16/2021  
Invitation Type Automatic  
Invitation Email(s) info@tmbscreenprinting.com

TMB Screen Printing & Embroidery Spring

Address 21602 Tatton Crest Ct  
Spring, TX 77388 Participation Type: Active Supplier

Invitation Date 04/16/2021  
Invitation Type Automatic  
Invitation Email(s) anita@tmbspring.com

TMB Screen Printing 2

Address 15552 FM 529 Rd.  
Houston, TX 77095 Participation Type: Active Supplier

Invitation Date 04/16/2021  
Invitation Type Automatic  
Invitation Email(s)

TMJ ENTERPRISES (Una Mae Dennison)

Address 8919 Wateka Drive  
Houston, TX 77074 Participation Type: Active Supplier

Classifications HUB,WBE (Primary)

Invitation Date 04/16/2021  
Invitation Type Automatic  
Invitation Email(s)

TNR Accounting & Management Consulting, LLC (Nannette Ray)

Address 24275 Katy Freeway  
Katy, TX 77494 Participation Type: Active Supplier

Classifications MBE (Primary),SBE,HUB,WBE

Invitation Date 04/16/2021  
Invitation Type Automatic  
Invitation Email(s) info@TNRaccounting.com

TNT Shirts

Address 2400 Taft St  
Houston, TX 77006 Participation Type: Active Supplier

Invitation Date 04/16/2021  
Invitation Type Automatic  
Invitation Email(s) ashley@tntshirts.com

TODAYS PROMOS

---

Address 17305 I-25 North Participation Type: Active Supplier  
Schertz, TX 78154

Classifications TAS,WBE (Primary)

Invitation Date 04/16/2021  
Invitation Type Automatic  
Invitation Email(s)

Today's Promotions (Today's Promos, LLC)

---

Address 26635 Forest Link Participation Type: Active Supplier  
New Braunfels, TX 78132

Classifications TAS,WBE (Primary)

Invitation Date 04/16/2021  
Invitation Type Automatic  
Invitation Email(s) Barbara@BroadMindsInvesting.com

Total Graphic Designs

---

Address 20904 Azalea Lane Participation Type: Active Supplier  
New Caney, TX 77357

Classifications SBE (Primary)

Invitation Date 04/16/2021  
Invitation Type Automatic  
Invitation Email(s)

Trademarks Promotional Products

---

Address 11333 Todd Street Participation Type: Active Supplier  
Houston, TX 77055

Classifications HUB,WBE (Primary)

Invitation Date 04/16/2021  
Invitation Type Automatic  
Invitation Email(s) renellec@tmarks.com KimQ@Tmarks.com  
Response Status Viewed  
Status Date 05/11/2021

Trading Club International, Inc.

---

Address 10818 Fern Terrace Participation Type: Active Supplier  
Houston, TX 77075

Invitation Date 04/16/2021  
Invitation Type Automatic  
Invitation Email(s) geoffreybailey@live.com

Trainers Warehouse (Offic Images, Inc)

---

Address 89 Washington Ave Participation Type: Active Supplier  
Natick, MA 01760-3441

Classifications SBE,WBE (Primary)

Invitation Date 04/16/2021  
Invitation Type Automatic  
Invitation Email(s) joyce@trainerswarehouse.com

Transcare llc

---

Address 9203 hwy 6 S Participation Type: Active Supplier  
Houston, TX 77083

Invitation Date 04/16/2021  
Invitation Type Automatic  
Invitation Email(s) transcarehou@gmail.com



Translation & Interpretation Network (Catholic Charities Diocese of Fort Worth, Inc. d/b/a Translation & Interpretation Network)

Address 249 W. Thornhill Drive Participation Type: Active Supplier  
Fort Worth, TX 76115

Invitation Date 04/16/2021  
Invitation Type Automatic  
Invitation Email(s) tin@tintranslation.com

Trezvant Academy, Inc

Address 9538 Curry Landing DR Participation Type: Active Supplier  
Houston, TX 77095

Invitation Date 04/16/2021  
Invitation Type Automatic  
Invitation Email(s) trezvantlinda@yahoo.com

Triangle Reproductions

Address 8450 Westpark, Suite 100 Participation Type: Active Supplier  
Houston, TX 77063

Classifications SBE (Primary)

Invitation Date 04/16/2021  
Invitation Type Automatic  
Invitation Email(s) bchristy@triangletexas.com

Trinity Enterprise Group LLC

Address 400 S Zang Blvd Ste 240 Participation Type: Active Supplier  
Dallas, TX 75208

Invitation Date 04/16/2021  
Invitation Type Automatic  
Invitation Email(s) casey@tegroup.biz  
Response Date 05/17/2021  
Response Status Submitted  
Status Date 05/17/2021

Triple D Uniform, Inc

Address 4031 Southerland Rd Participation Type: Active Supplier  
Houston, TX 77092

Classifications SBE (Primary)

Invitation Date 04/16/2021  
Invitation Type Automatic  
Invitation Email(s) phil@tripeduniform.com

Trophy House LLC (Ash Seawright (sole proprietor))

Address 804 W. Dallas Street, Suite 3 Participation Type: Active Supplier  
Conroe, TX 77301

Invitation Date 04/16/2021  
Invitation Type Automatic  
Invitation Email(s) trophyhouse@suddenlinkmail.com

T-Shirts Etc. West Houston (Clutch City Services, Limited Liability Company)

Address 1718 Fry Road Participation Type: Active Supplier  
Houston, TX 77084

Classifications MBE (Primary),SBE

Invitation Date 04/16/2021  
Invitation Type Automatic  
Invitation Email(s) hatim@tshirtsetcwesthouston.com

T-Shirts Ink

Address 1039 Pruitt Rd  
The Woodlands, TX 77380 Participation Type: Active Supplier

Invitation Date 04/16/2021  
Invitation Type Automatic  
Invitation Email(s) jdp@tshirtsinkandmore.com

Turner Sign Systems

Address 7110 Burns St  
Richland Hills, TX 76118 Participation Type: Active Supplier

Invitation Date 04/16/2021  
Invitation Type Automatic  
Invitation Email(s) amy@turnersignsystems.com

Two Guys Laser Engraving

Address 19850 FM 986  
Terrell, TX 75160 Participation Type: Active Supplier

Classifications SBE (Primary)

Invitation Date 04/16/2021  
Invitation Type Automatic  
Invitation Email(s) chad@twoguylaserengraving.com

TXTREME PROMOTIONS

Address 20550 TOWNSEN BLVD  
HUMBLE, TX 77338 Participation Type: Active Supplier

Invitation Date 04/16/2021  
Invitation Type Automatic  
Invitation Email(s) apparel@txtreme.com

U. S. WHOLESALE PRODUCTS

Address PO BOX 34483  
SAN ANTONIO, TX 78265 Participation Type: Active Supplier

Classifications SBE (Primary)

Invitation Date 04/16/2021  
Invitation Type Automatic  
Invitation Email(s) uswpsanantonio@gmail.com

U.S Electronics recycling Center Inc (Isaac F Sunday)

Address 6210 S Dairly Ashford Suite A4  
Houston, TX 77072 Participation Type: Active Supplier

Classifications MBE (Primary),SBE

Invitation Date 04/16/2021  
Invitation Type Automatic  
Invitation Email(s) sunif1985@yahoo.com

U.S. Flag and Flagpole Supply, LP

Address 4355 W. Cardinal Drive  
Beaumont, TX 77705 Participation Type: Active Supplier

Classifications SBE (Primary)

Invitation Date 04/16/2021  
Invitation Type Automatic  
Invitation Email(s)

**Ultra Print LLC**

---

Address 2116 Oleander Dr Participation Type: Active Supplier  
Texas, TX 78573

Classifications MBE (Primary),SBE,WBE

Invitation Date 04/16/2021  
Invitation Type Automatic  
Invitation Email(s) ultraprintllc1@gmail.com

**Ulysses S Dotson & Assoc.,Inc**

---

Address 2107 Isabella Street Participation Type: Active Supplier  
Houston, TX 77004

Classifications MBE (Primary),SBE

Invitation Date 04/16/2021  
Invitation Type Automatic  
Invitation Email(s) usdotson@gmail.com

**UNBEATABLE SALE INC**

---

Address 195 LEHIGH AVE Participation Type: Active Supplier  
LAKEWOOD, NJ 08701

Invitation Date 04/16/2021  
Invitation Type Automatic  
Invitation Email(s) hmelendez@unbeatable-sale.com

**UniFirst Corporation**

---

Address 455 Airport Rd. Participation Type: Active Supplier  
Corpus Christi, TX 78405

Invitation Date 04/16/2021  
Invitation Type Automatic  
Invitation Email(s) ryan\_jay@unifirst.com

**UNIFORM WORLD INC**

---

Address 12225 Greenville Ave Participation Type: Active Supplier  
Dallas, TX 75243

Classifications SBE (Primary)

Invitation Date 04/16/2021  
Invitation Type Automatic  
Invitation Email(s) Uniformworld@att.net

**UNIFORMS INCORPORATED**

---

Address 1489 PRUDENTIAL DRIVE Participation Type: Active Supplier  
DALLAS, TX 75235

Invitation Date 04/16/2021  
Invitation Type Automatic  
Invitation Email(s)

**Uniforms Manufacturing, Inc**

---

Address 7575 E. Redfield ave Participation Type: Active Supplier  
Scottsdale, AZ 85260

Classifications SBE (Primary)

Invitation Date 04/16/2021  
Invitation Type Automatic  
Invitation Email(s) Larry@UMIdirect.com

Unity Education Resources (MyOfficeProducts, LLC)

Address 22 Century Blvd  
Nashville, TN 37214 Participation Type: Active Supplier

Classifications TIP (Primary)

Invitation Date 04/16/2021  
Invitation Type Automatic  
Invitation Email(s) ken.ash@unityeducate.com

Unlimited Print (Mayer Enterprises)

Address 5522 Mitchelldale  
Houston, TX 77092 Participation Type: Active Supplier

Classifications SBE (Primary)

Invitation Date 04/16/2021  
Invitation Type Automatic  
Invitation Email(s)

UPKEEP PRESERVATION SERVICES LLC (MARIN)

Address 6302 GULF FREEWAY  
HOUSTON, TX 77023 Participation Type: Active Supplier

Classifications MBE (Primary),HUB

Invitation Date 04/16/2021  
Invitation Type Automatic  
Invitation Email(s) amupkeep@gmail.com

US Executive LLC

Address 401 E. Jackson St Ste 2340D  
Tampa, FL 33602 Participation Type: Active Supplier

Classifications SBE (Primary)

Invitation Date 04/16/2021  
Invitation Type Automatic  
Invitation Email(s) ronnie.dempsey@us-executive.com

USG Staffing LLC

Address 7601 FM 1960 E # 130  
Humble, TX 77396 Participation Type: Active Supplier

Invitation Date 04/16/2021  
Invitation Type Automatic  
Invitation Email(s)

USI Education and Government Sales (New Precision Technology, LLC)

Address 98 Fort Path Rd  
Madison, CT 06443 Participation Type: Active Supplier

Invitation Date 04/16/2021  
Invitation Type Automatic  
Invitation Email(s) agianacoplos@usi-corp.com

Utturn Concepts Inc

Address 1501 Shady Villa Fern  
Houston, TX 77055 Participation Type: Active Supplier

Classifications MBE,SBE (Primary),HUB,WBE

Invitation Date 04/16/2021  
Invitation Type Automatic  
Invitation Email(s) ayoka\_o@uturnconcepts.com

V R Promotions LLC

Address 7920 Camp Bowie West Blvd Participation Type: Active Supplier  
Fort Worth, TX 76116

Invitation Date 04/16/2021  
Invitation Type Automatic  
Invitation Email(s) vpatel@vrtexaspromotions.com

Valley Trophies, LLC

Address 529 S. Texas Blvd. Participation Type: Active Supplier  
Weslaco, TX 78596

Invitation Date 04/16/2021  
Invitation Type Automatic  
Invitation Email(s) travis@valleytrophiesweslaco.com

Varsity Brands Holding Co., Inc. (Varsity Spirit Fashions)

Address 6745 Lenox Center Ct., Ste. 300 Participation Type: Active Supplier  
Memphis, TN 38115

Classifications TAS (Primary),TCP

Invitation Date 04/16/2021  
Invitation Type Automatic  
Invitation Email(s) oebids@varsity.com

Varsity Impact (Varsity Brands Holding Co., Inc.)

Address 6745 Lenox Center Ct., Ste. 300 Participation Type: Active Supplier  
Memphis, TN 38115

Invitation Date 04/16/2021  
Invitation Type Automatic  
Invitation Email(s)

Varsity Spirit Fashion

Address 6745 Lenox Center Ct., Ste. 300 Participation Type: Active Supplier  
Memphis, TN 38115

Classifications TAS (Primary)

Invitation Date 04/16/2021  
Invitation Type Automatic  
Invitation Email(s) oebids@varsity.com

VCI Group Inc.

Address 3773 Richmond Ave Participation Type: Active Supplier  
Houston, TX 77046

Invitation Date 04/16/2021  
Invitation Type Automatic  
Invitation Email(s)

VECOMPRESS (AUTOMEDLAND)

Address 1200 Blalock Rd Participation Type: Active Supplier  
Houston, TX 77055

Invitation Date 04/16/2021  
Invitation Type Automatic  
Invitation Email(s) isosa@vecopress.net

Vestige International

Address 10201 Buffalo Spwy.  
Houston, TX 77054 Participation Type: Active Supplier

Classifications MBE,SBE (Primary)

Invitation Date 04/16/2021  
Invitation Type Automatic  
Invitation Email(s) tredell@vestigeinternational.com

Virginia

Address 101 N 14th St  
Richmond, VA 23219 Participation Type: Active Supplier

Invitation Date 04/16/2021  
Invitation Type Manual  
Invitation Email(s)

Visiontron Corp.

Address 720 Old Willets Path  
Hauppauge, NY 11788 Participation Type: Active Supplier

Classifications SBE (Primary)

Invitation Date 04/16/2021  
Invitation Type Automatic  
Invitation Email(s) donnag@visiontron.com kristic@visiontron.com

VS Athletics

Address 3474 Emprse Dr ste. 120  
San Luis Obispo, CA 93401 Participation Type: Active Supplier

Invitation Date 04/16/2021  
Invitation Type Automatic  
Invitation Email(s) Carl@vsathletics.com

VSA, Inc

Address 6929 Seward Ave  
Lincoln, NE 68507 Participation Type: Active Supplier

Invitation Date 04/16/2021  
Invitation Type Automatic  
Invitation Email(s)

Walk the Walk Promotions

Address 1206 Apollo Road #850363  
Richardson, TX 75085 Participation Type: Active Supplier

Invitation Date 04/16/2021  
Invitation Type Automatic  
Invitation Email(s) june@walkthewalkpromotions.com

Walker's Empire Services

Address 7130 SIENA VISTA DR  
houston, TX 77083 Participation Type: Active Supplier

Classifications MBE,SBE (Primary),WBE

Invitation Date 04/16/2021  
Invitation Type Automatic  
Invitation Email(s) dmcghee2@yahoo.com

Walls Printing (KPW Enterprises)

Address 9171 King Arthur Drive Participation Type: Active Supplier  
Dallas, TX 75247

Invitation Date 04/16/2021  
Invitation Type Automatic  
Invitation Email(s) lisa@wallsprinting.com

Washington

Address P.O. Box 41160 Participation Type: Active Supplier  
Olympia, WA 98504

Invitation Date 04/16/2021  
Invitation Type Manual  
Invitation Email(s)

Waterbottles.com (Wb Promos, LLC)

Address 1242 E. Edna Pl Participation Type: Active Supplier  
Covina, CA 91724

Classifications MBE (Primary)

Invitation Date 04/16/2021  
Invitation Type Automatic  
Invitation Email(s) wzhai@waterbottles.com

WAYNE ENTERPRISES, INC. (WAYNE D. ENTERPRISES, INC.)

Address 14300 HOLLISTER Street STE 100 Participation Type: Active Supplier  
HOUSTON, TX 77066

Classifications HUB (Primary), WBE

Invitation Date 04/16/2021  
Invitation Type Automatic  
Invitation Email(s) george@wayne-ent.com

We Brand It Promotions

Address 1112 Austin St. Participation Type: Active Supplier  
Hempstead, TX 77455

Classifications MBE (Primary), SBE, HUB, WBE

Invitation Date 04/16/2021  
Invitation Type Automatic  
Invitation Email(s) office@webranditpromos.com  
Response Status Viewed  
Status Date 05/11/2021

Wendy Perry Coparenting Education (www.wendyperry.com)

Address 6028 Sundown Drive Participation Type: Active Supplier  
Watauga, TX 76148

Classifications WBE (Primary)

Invitation Date 04/16/2021  
Invitation Type Automatic  
Invitation Email(s) wendyperryconsulting@gmail.com

West Road Teacher Supply (Distribuidora Alfa y Omega Inc.)

Address 10266 North Freeway Participation Type: Active Supplier  
Houston, TX 77037

Classifications MBE (Primary)

Invitation Date 04/16/2021  
Invitation Type Automatic  
Invitation Email(s) NRTAMEZ@aol.com

West Virginia

---

Address 1900 Kanawha Blvd  
Charleston, WV 25305 Participation Type: Active Supplier

Invitation Date 04/16/2021  
Invitation Type Manual  
Invitation Email(s)

Western Lithograph

---

Address Tricia Londos  
Houston, TX 77092 Participation Type: Active Supplier

Invitation Date 04/16/2021  
Invitation Type Automatic  
Invitation Email(s) jrees@westernlithograph.com

Whitener Enterprises, Inc

---

Address 1296 FM 3083  
Conroe, TX 77301 Participation Type: Active Supplier

Invitation Date 04/16/2021  
Invitation Type Automatic  
Invitation Email(s) beth@whient.com bryan@whient.com wwatts4@aol.com

Wisconsin

---

Address P.O. Box 7864  
Madison, WI 53707 Participation Type: Active Supplier

Invitation Date 04/16/2021  
Invitation Type Manual  
Invitation Email(s)

Wood Alternator and Starter Service (Homer J. Wood)

---

Address 680 Aldine Mail Route Road  
Houston, TX 77037 Participation Type: Active Supplier

Classifications SBE (Primary)

Invitation Date 04/16/2021  
Invitation Type Automatic  
Invitation Email(s) hjwood@sbcglobal.net

Woodlands Trophies & Awards

---

Address 9079 Rocky Ridge Dr.  
Conroe, TX 77302 Participation Type: Active Supplier

Classifications HUB (Primary)

Invitation Date 04/16/2021  
Invitation Type Automatic  
Invitation Email(s) shop@woodlandstrophies.com

World Of Promotions

---

Address 1310 Louis Ave  
ELK Grove Village, IL 60007 Participation Type: Active Supplier

Classifications WBE (Primary)

Invitation Date 04/16/2021  
Invitation Type Automatic  
Invitation Email(s) rosenfeldlayla@yahoo.com



worldwide specialty advertising

---

Address 7999 Western Hills Blvd  
Ft Worth, TX 76108 Participation Type: Active Supplier

Classifications MBE,HUB (Primary)

Invitation Date 04/16/2021  
Invitation Type Automatic  
Invitation Email(s) les@wsapromos.com

www.signarama-katyfulshear.com

---

Address 25311 Kingsland Blvd #180  
Katy, TX 77494 Participation Type: Active Supplier

Invitation Date 04/16/2021  
Invitation Type Automatic  
Invitation Email(s)

www.spiritsupply.com

---

Address 1111 W. Carrier Pkwy  
Grand Prairie, TX 75050 Participation Type: Active Supplier

Invitation Date 04/16/2021  
Invitation Type Automatic  
Invitation Email(s) info@spiritsupply.com

Wylie Construction Services

---

Address 4830 Wilson Rd  
Humble, TX 77396 Participation Type: Active Supplier

Response Date 05/07/2021  
Response Status No Bid  
Status Date 05/07/2021

xtremetees embroidery and printing

---

Address 600 N Veterans Blvd suite D  
San Juan, TX 78589 Participation Type: Active Supplier

Invitation Date 04/16/2021  
Invitation Type Automatic  
Invitation Email(s) xtremetees18@gmail.com

Xyples LLC

---

Address 2601 La Frontera Blvd  
Round Rock, TX 78681 Participation Type: Active Supplier

Invitation Date 04/16/2021  
Invitation Type Automatic  
Invitation Email(s) tokenkwo@xyples.com

Youtopian Uniforms

---

Address 6455 Argyle Forest Blvd  
Jacksonville, FL 32244 Participation Type: Active Supplier

Classifications SBE (Primary)

Invitation Date 04/16/2021  
Invitation Type Automatic  
Invitation Email(s) service@youtopian.biz

Zion Redemption

Address 5530 Ridgecreek A350 Participation Type: Active Supplier  
Houston, TX 77053

Classifications SBE (Primary)

Invitation Date 04/16/2021  
Invitation Type Automatic  
Invitation Email(s) godsfavgirls@gmail.com

Z-Man Direct Inc.

Address 8602 Mile Run Rd. Participation Type: Active Supplier  
Humble, TX 77346

Invitation Date 04/16/2021  
Invitation Type Automatic  
Invitation Email(s) dan@zmandirect.com

ZNA DESIGN (ZNA GROUP LLC)

Address 25600 Westheimer Pkwy Participation Type: Active Supplier  
Katy, TX 77494

Invitation Date 04/16/2021  
Invitation Type Automatic  
Invitation Email(s)

Zone Swimwear (Zone International)

Address 1660 International Drive, Suite 600 Participation Type: Active Supplier  
McLean, VA 22102

Invitation Date 04/16/2021  
Invitation Type Automatic  
Invitation Email(s) jwingo@zoneswimwear.com

---

**Bid Activity Detail**

1st Advertisement

Activity Date 4/16/2021 08:00:00 AM (CT)  
Description

2nd Advertisement

Activity Date 4/19/2021  
Description

Pre-Proposal Meeting

Activity Date 4/21/2021 10:00:00 AM (CT)  
Description A non mandatory preproposal meeting has been set up for April 21, 2021 at 10:00 AM CT

<https://hcde-texas-org.zoom.us/j/83104885202?pwd=Y0xzVy90UUZvUWwzZHZzQTNyUGkrdz09>

Meeting ID: 831 0488 5202  
Passcode: 885567  
One tap mobile  
+13462487799,,83104885202#,,,,\*885567# US (Houston)  
+12532158782,,83104885202#,,,,\*885567# US (Tacoma)

Dial by your location  
+1 346 248 7799 US (Houston)  
+1 253 215 8782 US (Tacoma)  
+1 669 900 9128 US (San Jose)  
+1 312 626 6799 US (Chicago)  
+1 646 558 8656 US (New York)  
+1 301 715 8592 US (Washington DC) Meeting ID: 831 0488 5202  
Passcode: 885567  
Find your local number: <https://hcde-texas-org.zoom.us/u/kjbXq7DIE>

Deadline for Questions

---

Activity Date 5/13/2021 05:00:00 PM (CT)

Description Please submit any questions via the questions tab ahead of the deadline for questions.

Proposals Due / Public Bid Opening

---

Activity Date 5/18/2021 02:00:00 PM (CT)

Description HCDE/CP has set up a virtual bid opening meeting to announce the submitted respondents upon the bid close date and time.

Proposals Due / Proposal Opening  
May 18, 2021 at 2:00 p.m. CT

Join Zoom Meeting

<https://hcde-texas-org.zoom.us/j/88493557667?pwd=d1U0Q3poYjZS3E0dXkzTXdDUkl0dz09>

Meeting ID: 884 9355 7667

Passcode: 116952

One tap mobile

+13462487799,,88493557667#,,,,\*116952# US (Houston)

+16699009128,,88493557667#,,,,\*116952# US (San Jose)

Dial by your location

+1 346 248 7799 US (Houston)

+1 669 900 9128 US (San Jose)

+1 253 215 8782 US (Tacoma)

+1 312 626 6799 US (Chicago)

+1 646 558 8656 US (New York)

+1 301 715 8592 US (Washington DC) Meeting ID: 884 9355 7667

Passcode: 116952

Find your local number: <https://hcde-texas-org.zoom.us/u/klZZuwx5Q>

Anticipated Board Award

---

Activity Date 7/21/2021

Description

**Regular Board Meeting**

**8.E.8.**

<b>Meeting Date:</b>	July 21, 2021		
<b>Title:</b>	Contract Award for 21/058MJ for Energy Purchase		
<b>Submitted For:</b>	Joann Nichols, Choice Partners	<b>Submitted By:</b>	Cora Day
<b>Recommended Action:</b>	Approve	<b>HCDE Goal(s):</b>	4. Provide cost savings by leveraging tax dollars
<b>Additional Resource Personnel:</b>	Joann Nichols, Jeff Drury, Richard Vela, Yaritza Roman, Kendra Jackson and Dr. Jesus Amezcua	<b>Facilities/Technology Approval Needed?:</b>	None

**Information**

**Posted Agenda Item:**

**Approval of the Contract Award for job no. 21/058MJ for Energy Purchase with the following vendors:** NRG Energy, Inc. dba Reliant Energy Retail Services, LLC (#21/058MJ-01), and Vistra Preferred, Inc. dba TXU Energy Retail Company, LLC (#21/058MJ-02) for the period 07/21/2021 through 07/20/2022.

**Subject:**

Choice Partners; Contract Award; Energy Purchase; Revenue Generating

**Rationale:**

The process enacted was Request for Proposal (RFP) to acquire proposals from vendors to provide Energy Purchase to HCDE/Choice Partners members.

Two hundred eighty (280) invitations were extended for proposals. Three (3) responses were received from vendors. Each response was reviewed for compliance with the requirements of RFP no. 21/058MJ. All responses that met the criteria and requirements of the RFP were evaluated and scored. One (1) vendor was non-awarded, and two (2) vendors offering best value to HCDE/Choice Partners and its members were selected for award.

HCDE/Choice Partners recommends award of a one (1) year contract from 07/21/2021 to 07/20/2022 to the vendors stated above in Posted Agenda Item. Contract no. 21/058MJ has the option for up to three (3) annual renewals. Anticipated revenue from contract no. 21/058MJ will be an administrative fee of \$0.45/MWh for usage of 0-20,000 mWh, \$0.20MWh for usage of 20,001-40,000 mWh, and \$0.05/MWh for usage of 40,000+ mWh. This contract is governed by Texas Education Code 44.031.

**Fiscal Impact**

<b>Included in FY budget Y/N:</b>	Y
<b>Included in current budget amendment Y/N:</b>	N

**Attachments**

- Recommendation Report
- Evaluation Summary
- Participation Listing



Harris County Department of Education  
Choice Partners  
Proposal Recommendation Form  
Program Review

[This form is used to document due diligence by Recommendation Committee]

To: Kendra Jackson, HCDE Director of Purchasing  
From: Monique Joseph

Stephen Kendrick  
Yaritza Roman  
Mary Causey

Job (Bid or RFP#) and Name: 21/058MJ  
Energy Purchase  
Board Meeting Date: 7/21/2021  
Date: 6/22/2021

**Procurement Requirements Available:**

Check One

- Under \$2,500 (Requires Division Director and Asst Supt. Approval)
- From \$2,500 to \$50,000 (Requires Buyer, Purchasing Director/CFO Approval)
- Over \$50,000 (per CH Local)
- Cooperative Programs (Requires Board Approval)

I certify that I have reviewed the attached RFP and certify that all of my actions as a Recommendations Committee Member are within the procurement requirements in accordance with local Board Policies (CH local/legal) and legal (federal and state) policies and administrative guidelines set by the Business Office and Purchasing Division.

I certify that I have adhered to the Purchasing Policies of HCDE concerning the review of this RFP to include policies on conflict of interest (CIQ).

I certify that I am aware of all purchasing policies (CH Local and CH Legal) and administrative procedures of HCDE.

I certify that I am aware of the penalties of not following the purchasing policies and procedures and in specific with section 44.032 of the Texas Education Code which deals with the penalties related to sequential or component purchases.

I further certify that I recommend the execution of a contract after Board approval.

(Note: This form is required of all jobs (bids and RFPs) prepared by all buyers & directors.)

**Justification:**

(Any information that pertains to this job (bid or RFP))

21/058MJ Energy Purchase

Choice Partners members will utilize this contract for Energy Purchase

This contract will provide a discounted price, superior quality, and comply with state purchasing requirements as stated in TEC §44.031.

This job was competitively bid and advertised. The result of the bid generated the following responses:

Invitations were sent to 280 vendors  
HCDE received 3 responses (see attached evaluation summary).

**Recommendation:**

HCDE is recommending with Choice Partners Cooperative for:	NRG Energy, Inc. (Reliant Energy Retail Services, LLC) Vistra Preferred Inc. (TXU Energy Retail Company LLC)
--	---



**Harris County Department of Education  
Choice Partners  
Instructions to Recommendation Committee**

**[This form is used to document due diligence by Recommendation Committee]**

---

**To:** Dr. Jesus J. Amezcua, CPA, Assistant Supt. for Business Services  
**From:** Monique Joseph  
**Job (Bid or RFP) # and Name:** 21/058MJ  
Energy Purchase  
**Board Meeting Date:** 7/21/2021  
**Today's Date:** 6/22/2021

Attached are the following materials for your review and possible recommendation to the Superintendent and the Board of Trustees:

Buyer Certification  
Bid Tabulation  
Copy of the Job (Bid or RFP) responses  
Set of Specs will be available for your review

Your responsibility for review of this job (bid or RFP) is to make sure that HCDE receives the best value for the goods and services sought. Please review the attached job (bid or RFP) and certify that all of the procurement requirements have been met in accordance with local Board Policies and legal (federal and state) policies and administrative guidelines set by the Business Office and the Purchasing Division.

Please remember to adhere to section 44.032 of the Texas Education Code, "Enforcement of Purchase Procedures: Criminal Penalties; Removal; Ineligibility" which deal with the penalties related to component, separate, and sequential purchases. In addition, Board policy CH Local and Legal are required to be met as part of your contractual obligation with HCDE.

It should be noted that if a required document is not provided by the bidder, the Purchasing Division will not be able to make a recommendation and or issue a purchase order.

Please review the responses to the job (bid or RFP) and submit the following forms by the required deadline for the next available Board Meeting:

**Signed Certification and Recommendation Form**

If any technicalities or changes need to be made, these must be addressed in the recommendation and presented as such to the Superintendent and the Board of Trustees.

**Agenda Item (Prepared by Buyer handling the job/bid or RFP)**

Once, a recommendation is approved by the Board, Choice Partners will issue an award letter and request that any pending bonds or contracts be submitted within 5 days to the District.



Harris County Department of Education  
Choice Partners  
Effectiveness and Compliance Review Form

**[This form is used to document due diligence by Recommendation Committee]**

To: Purchasing Audit File and Jesus J. Amezcua, CPA, Assistant Supt. for Business  
From Contract Manager: Monique Joseph  
Purchasing Dept: Kendra Jackson, Director  
  
Job- Bid or RFP# and Name: 21/058MJ  
Energy Purchase  
Board Meeting Date: 7/21/2021  
Date: 6/22/2021

**Procurement Requirements Available:**

Check One

\_\_\_\_\_ Under \$2,500 (Requires Division Director and Asst Supt. Approval)  
\_\_\_\_\_ From \$2,500 to \$50,000 (Requires Buyer, Purchasing Director/CFO Approval)  
\_\_\_\_\_ Over \$50,000 (per CH Local)  
\_\_\_\_\_ X \_\_\_\_\_ Cooperative Programs (Requires Board Approval)

I certify that I have reviewed the attached job (bid or RFP) and certify that all of my actions as a Recommendations Committee Member are within the procurement requirements in accordance with Local Board Policies (CH Local/Legal) and Legal (Federal and State) policies and administrative guidelines set by the Business Office and the Purchasing Division.

I certify that I have adhered to the Purchasing Policies of HCDE concerning the review of this job (bid or RFP) to include policies on conflict of interest.

I certify that I am aware of all purchasing policies (CH Local and CH Legal) and administrative procedures of HCDE.

I certify that I am aware of the penalties of not following the purchasing policies and procedures and in specific with section 44.032 of the Texas Education Code which deals with the penalties related to sequential or component purchases. I further certify that I recommend the issuance of a purchase order after Board approval and execution of a contract.

(Note: This form is required of all jobs (bids and RFPs) prepared by all buyers and directors.)



**Energy Purchase**

Evaluation Criteria	Total Weighted Value	Rave Energy	Reliant Energy Retail Services, LLC	TXU Energy Retail Company, LLC	
<b>Averages</b>					
(1) Price Overall Cost of Program Pricing as determined by the proposal submitted Pricing may also be based upon usage and coverage	40	21.67	35.67	34.67	
(2) Vendor's experience and reputation References for local governmental entities and with a purchasing cooperative program Local government agencies within the past 5 years Other projects completed within the past 10 years	20	10.67	16.67	19.33	
(3) Quality of Vendor's products/services and extent to which the products/services meet HCDE and HCDE members' needs: Project Management Infrastructure Solutions Quality of Vendor's Products/Service Demonstrated Ability to Perform	25	16.67	20.00	23.33	
(4) Impact on the ability of HCDE members to comply with laws and rules relating to HUB/MWBE/SBE/PDBE/DBE	0	0.00	0.00	0.00	
(5) Whether Vendor's financial capability is appropriate to the size and scope of the project and the total long-term cost to HCDE and HCDE members to acquire the products/service	5	2.33	5.00	4.67	
(6) For a contract for goods and services, other than goods and services related to telecommunications and information services, building construction and maintenance, or instructional materials, whether the Vendor or the Vendor's ultimate parent company or majority owner: (A) has its principal place of business in this state; or (B) employs at least 500 persons in this state	0	0.00	0.00	0.00	
(7) Vendor's past relationship with HCDE/CP	5	0.00	5.00	5.00	
(8) Marketing Plan	5	3.67	5.00	4.67	
<b>Evaluators: Total</b>	<b>100</b>	<b>55.01</b>	<b>87.34</b>	<b>91.67</b>	
Stephen Kendrick HCDE		Invitations were sent to	280	prospective bidders.	
Yaritza Roman HCDE		Contracts are in accordance with TEC 44.031			
Mary Causey Choice Partners		It is recommended that the following awards of annual contracts:			
<b>Non-Responsive</b>		<b>0</b>	<u>Contract Vendor</u>		
<b>Non-Awarded</b>		<b>1</b>	21/058M-01 Reliant Energy Retail Services, LLC		
<b>Award Threshold of 70</b>	<b>2</b>	21/058M-02 TXU Energy Retail Company, LLC			
<b>Total Responses</b>	<b>3</b>				

# Harris County Department of Education

## Participation Detail as of 6/10/2021 02:12:26 PM (CT)

### Bid Information

Bid Creator Monique Joseph Contract Manager  
 Email mojoseph@hcde-texas.org  
 Phone  
 Fax

Bid Number 21/058MJ  
 Title Energy Purchase  
 Bid Type Request for Proposal  
 Issue Date 5/14/2021 08:00 AM (CT)  
 Close Date 6/10/2021 02:00:00 PM (CT)

### Participation Summary

Company Name	City, State	Invitation Date	Status	Status Date	Response Date
1-Stop Enterprises LLC	Little Elm, TX	05/14/2021			
2Tier Wholesalers	Garland, TX	05/14/2021			
365 Paving & Construction LLC	Mission, TX	05/14/2021			
A C Electric Rental & Sales (Alt Current Electric Rental,LLC)	Montgomery, TX	05/14/2021			
A.J.Hurt,Jr.,Inc. dba Reladyne	Houston, TX	05/14/2021			
AAA Painting	Houston, TX	05/14/2021			
AARACO ENERGY SERVICES (AARACO EXPLORATION, INC.)	Spring, TX 77379, TX	05/14/2021			
AC/DC Synergy Group	Tomball, TX	05/14/2021	No Bid	06/08/2021	06/08/2021
Acclaim Energy Advisors (Acclaim Energy, Ltd.)	Houston, TX	05/14/2021			
advanced fleet maintenance	Cleveland, TX	05/14/2021			
Advantage office products	Houston, TX	05/14/2021			
Advantage Office Products, LLC	Benbrook, TX	05/14/2021			
AEG Affiliated Energy Group	Houston, TX	05/14/2021			
AES Enterprises	New Caney, TX	05/14/2021			
AGH2O Holdings, LLC	Round Rock, TX	05/14/2021			
Air Comfort, Inc.	Beaumont, TX	05/14/2021	Viewed	06/08/2021	
Aleddra (Lightel Technologies, Inc.)	Renton, WA	05/14/2021			
Alexander Development and Leasing Company LLC	RACINE, WI	05/14/2021			
Allied Signs	Houston, TX		Viewed	05/28/2021	
Alspaugh's Ace Hardware in The Woodlands, LLC	The Woodlands, TX	05/14/2021			
Alvin Equipment Company	Alvin, TX	05/14/2021			
Ameresco, Inc.	Dallas, TX	05/14/2021	Viewed	06/08/2021	
Amerex Energy Services (Amerex Brokers LLC)	Sugar Land, TX	05/14/2021	Viewed	05/19/2021	
AMERICAN FLOORING SERVICES	Richmond, TX	05/14/2021			
AMERICAN MADE SOLAR AND WIND (MARDEL SOUZA INC)	BROWNSVILLE, TX	05/14/2021			
AMS Electric Inc.	Tempe, AZ	05/14/2021			
Anderson Hydra Platforms, Inc.	York, SC	05/14/2021			
Aramark Management Services Limited Partnership (Aramark SMMS LLC)	Philadelphia, PA	05/14/2021			
ATViroTech Inc.	Missouri City, TX	05/14/2021			
Bath Fitter	San Antonio, TN	05/14/2021			
Batteries Plus Bulbs #468 (Kingdom Alliance,LLC)	College Station, TX	05/14/2021			
Batteries Plus Bulbs, Humble (Shookalot, Inc.)	Humble, TX	05/14/2021			
BEASLEY TIRE SERVICE, INC	HOUSTON, TX	05/14/2021			
Bee (Nodal Partners)	Austin, TX	05/14/2021			
BenchMark Facility Solutions, LLC	Dallas, TX	05/14/2021			
Bernhard (Bernhard MCC LLC)	Houston, TX	05/14/2021			
Better Efficiency Solutions and Technologies	Austin, TX	05/14/2021			
Beyond Controls Inc.	Houston, TX	05/14/2021			
BidDesk Analytics	Lincoln Park, NJ	05/14/2021			

BioSafe Systems, LLC	East Hartford, CT	05/14/2021			
Blackland Glass & Construction	Greenville, TX	05/14/2021			
Bocci Engineering, LLC	Cypress, TX	05/14/2021			
Bolo Stick LLC	Warren, OH	05/14/2021			
Brahmarsk Corporation	Sugar Land, TX	05/14/2021			
BRB Supply	Houston, TX	05/14/2021			
Briar Patch	Houston, TX	05/14/2021			
Brooke's Learning Corner LLC.	houston, TX	05/14/2021			
BTM SOLUTIONS LLC	Spring, TX	05/14/2021			
BUDGET RESTAURANT SUPPLY (TAI HING CORPORATION)	Houston, TX	05/14/2021			
Building Material Supply, Inc.	Austin, TX	05/14/2021			
Building Optimization Technologies	Houston, TX	05/14/2021			
C&L Consulting	Houston, TX	05/14/2021			
C&W Electric Supply (CRAWFORD AND WILSON ENTERPRISES INC.)	Plano, TX	05/14/2021			
Capitol Air Conditioning Services (Capitol Air Conditioning Services LLC,)	Georgetown, TX	05/14/2021			
Caprock Electric	Houston, TX	05/14/2021			
Catalyst PR INC	Conroe, TX	05/14/2021			
CB Solutions LP	Lago Vista, TX	05/14/2021			
CDM Contracting Services	Brownsville, TX	05/14/2021			
Child Care Associates	FORT WORTH, TX	05/14/2021			
Choice! Energy Services Retail, LP	HOUSTON, TX	05/14/2021	No Bid	05/14/2021	05/14/2021
cleaningsence LLC	HOUSTON, TX	05/14/2021			
Climatec LLC	Houston, TX	05/14/2021	Viewed	05/24/2021	
Coastal Air Balance Corp.	Metairie, LA	05/14/2021			
Combined Refrigeration Resources, Inc.	Humble, TX	05/14/2021			
Comflow Mechanical Services	Houston, TX	05/14/2021			
Computer Station Corporation	Houston, TX	05/14/2021			
Computrols of Texas (Computrols, Inc)	Gretna, LA	05/14/2021			
ConEd Solutions (Consolidated Edison Solutions, Inc.)	Valhalla, NY	05/14/2021			
Conservation Station	Chapel Hill, NC	05/14/2021			
Constellation Energy (Constellation NewEnergy, Inc.)	Houston, TX	05/14/2021			
Control Products (C.P. Distributors LLP)	Houston, TX	05/14/2021			
Control Specialties	Gainesville, GA	05/14/2021			
Convergentz (Greens Road B, LLC)	Houston, TX	05/14/2021			
Cotton Commercial USA	Katy, TX	05/14/2021			
Council Rock Enterprises, LLC	Rochester, NY	05/14/2021			
Crawford Electric Supply Co.	Houston, TX	05/14/2021			
Custom Air Products & Services, Inc.	Houston, TX	05/14/2021			
CVAL Innovations (CVAL Innovations LLC)	Irving, TX	05/14/2021			
Cyclone FPV (Cyclone 3D, Inc.)	Spring, TX		Viewed	05/16/2021	
Cy-Fair Tire (Keilers Holdings, Inc.)	Brenham, TX		No Bid	06/08/2021	06/08/2021
D & R Electric Company	San Antonio, TX	05/14/2021			
Dalkia Energy Solutions	Beverly, MA	05/14/2021			
Danny's Laundry Service	Pasadena, TX	05/14/2021			
Dataprobe Inc.	Allendale, NJ	05/14/2021			
Delta Air Conditioning and Heating LLC	Houston, TX	05/14/2021			
Demand Lighting USA, Inc.	Austin, TX	05/14/2021			
DGR United	houston, TX	05/14/2021			
Direct Energy	Houston, TX		Viewed	06/07/2021	
Duran Industries Inc.	Richardson, TX	05/14/2021			
Eaton (Eaton Corporation)	Cleveland, OH	05/14/2021			
Educational Systems Consulting	Binghamton, NY	05/14/2021			
EL PASO BOLT & SCREW CO., INC	El Paso, TX	05/14/2021			
Electrical Distributors LLC	Houston, TX	05/14/2021			
Elite Water and Coffee	Ridgeland, MS	05/14/2021			
E-Logic, Inc.	Washington, DC	05/14/2021			
Empowered Network Services, LLC	Huffman, TX	05/14/2021			
Energy Saving Advisor Distributors	Dallas, TX	05/14/2021	Viewed	05/17/2021	
Epic Solar Control, LLC	Mckinney, TX		Viewed	06/01/2021	
Evco Partners LP dba Burgoon Company	Galveston, TX	05/14/2021			
Evertex LLC	Flemington, NJ	05/14/2021			
ExerPlay, Inc	Cedar Crest, NM	05/14/2021			

FACILITIES INTEGRATED SOLUTIONS & CONSULTING LLC	CYPRESS, TX	05/14/2021			
Facility Response Group	San Marcos, TX	05/14/2021			
Facility Solutions Group	houston, TX	05/14/2021			
Fastenal Company	Winona, MN	05/14/2021			
Flicgroup (Federal lighting illumination capital)	Southlake, TX	05/14/2021			
Fors Lux Group (Fors Lux Group Corporation)	Houston, TX	05/14/2021			
Franklin D Saulsberry LLC	Porter, TX		Viewed	05/22/2021	
G&E Industrial Supplies Inc.	El Paso, TX	05/14/2021	Viewed	05/14/2021	
G4C Enterprises, LLC	Pflugerville, TX		Viewed	05/23/2021	
Gazelle Capital, LLC	Saint Petersburg, FL	05/14/2021			
GDF Suez Energy Resources NA	Houston, TX	05/14/2021			
Geaux Crates & Storage, LLC	Houston, TX, TX	05/14/2021			
Gene's Machine, INC.	Victoria, TX	05/14/2021			
GermBlast (Infection Controls, Inc.)	Lubbock, TX	05/14/2021			
GermWrap	New Braunfels, TX	05/14/2021	Viewed	05/14/2021	
GH Mechanical and Services LLC	Houston, TX	05/14/2021			
Gilbarco Inc.	Greensboro, NC	05/14/2021			
GMP Media Group	Atlanta, GA	05/14/2021			
Good Faith Energy	Richardson, TX	05/14/2021			
Gray Mechanical (Gray Mechanical, LLC)	Houston, TX	05/14/2021			
Graybar Electric Company, Inc.	St Louis, MO	05/14/2021			
Gruber Power Services (Gruber Technical Inc.)	Phoenix, AZ	05/14/2021			
GSI Highway	Dallas, TX	05/14/2021			
Gulf Coast Nut & Bolt LLC	Corpus Christi, TX	05/14/2021			
Gulf States Laundry Machinery	Houston, TX	05/14/2021			
Gulftex (B J Interest, Inc.)	Houston, TX	05/14/2021			
Haynes Mechanical Systems, Inc.	Greenwood Village, CO	05/14/2021			
Heat Transfer Solutions (HTS Texas)	Houston, TX	05/14/2021			
Herc Rentals	Houston, TX	05/14/2021			
Hercules Poly	Eclectic, AL	05/14/2021			
Heritage Institute of Sustainability LLC	Dallas, TX	05/14/2021			
Hill Country Computer (HCC)	Waxahachie, TX	05/14/2021			
Honesty Construction Group (HCG Management LLC)	Manvel, TX	05/14/2021			
Hoodz of Greater Houston & College Station (SparkySpark Inc)	Montgomery, TX	05/14/2021			
Hou-Tex Glass & Mirror Co (Hou Tex Newnom Inc.)	Houston, TX	05/14/2021			
Hunton Services (HVAC Mechanical Services of Texas LTD)	Houston, TX	05/14/2021			
I/S Mechanical (Inno/lution)	Spring, TX	05/14/2021			
Indatatech (Instant Data Technologies, Inc.)	San Antonio, TX	05/14/2021			
INFINITY CONTRACTORS INT'L LTD	FORT WORTH, TX	05/14/2021			
Influent Energy (Distributed Generation and Storage, LLC)	Kansas City, MO	05/14/2021	Viewed	05/14/2021	
Information & Energy Services, Inc.	SAN DIEGO, CA	05/14/2021			
Interstate All Battery Center (Interstate Battery)	EULESS, TX	05/14/2021			
ISC Sales, Inc.	Plano, TX	05/14/2021			
J&H Energy Consultants	Houston, TX	05/14/2021	Viewed	05/14/2021	
JAVACCS, LLC	Humble, TX	05/14/2021			
JEGAS Construction	Houston, TX	05/14/2021			
Jet Industrial Service Group	Vidor, TX	05/14/2021			
Jorrie Martin LLC	San Antonio, TX	05/14/2021			
kaizen Renewable Energy (kaizen Endeavors, Inc.)	Dallas, TX	05/14/2021			
KANKO (Floyd's Chores & Odd Jobs)	Dallas, TX	05/14/2021			
Kentech Inc.	Porter, TX	05/14/2021	No Bid	06/08/2021	06/08/2021
Koch Filter Corporation	Louisville, KY	05/14/2021			
L&S Associates, LLC	Montgomery, TX	05/14/2021			
Landmark Electric Company (Landmark Electric Co.)	Corpus Christi, TX	05/14/2021			
Lange Mechanical Services, L.P.	Houston, TX	05/14/2021			
Laser Imaging (Hallmarks Laser Imaging)	Houston, TX	05/14/2021			
Leather Only Products	Houston, TX	05/14/2021			
LEDs Unlimited LLC	Lago Vista, TX	05/14/2021			
Levy's Tutorial and Enrichment Center (Mary Baumann)	Houston, TX		No Bid	05/28/2021	05/28/2021

Lexine Group (Lexine Inc)	McAllen, TX	05/14/2021			
Lowes Companies Inc	Mooreville, NC	05/14/2021			
LVI Energy	Plano, TX	05/14/2021			
M&H Lighting Systems (Mapenzi Group)	Pearland, TX	05/14/2021			
M.E.N. (Mentoring, Educating & Nurturing) Incorporated (MEN Inc.)	Houston, TX		No Bid	05/15/2021	05/15/2021
MAINLAND SUPPLY	San Marcos, CA	05/14/2021			
Malor & Company Inc	New York, NY	05/14/2021			
MANS DISTRIBUTORS, INC.	Carrollton, TX	05/14/2021			
Mansfield Power and Gas, LLC	Gainesville, GA	05/14/2021			
Mata Boxing Promotions- MBP (Jason Mata)	SAN ANTONIO, TX	05/14/2021			
Mats Unlimited	Terrell, TX	05/14/2021			
MAVICH	Southlake, TX	05/14/2021			
Mayfield Paper Co	San Angelo, TX	05/14/2021			
McKinstry (McKinstry Essention, Inc.)	Dallas, TX	05/14/2021			
McMac Commissioning Services, LLC.	Houston, TX	05/14/2021			
MCS Enterprises	Houston, TX	05/14/2021			
Meredith Digital	SANTA ANA, CA	05/14/2021			
METCO Engineering, Inc.	Dallas, TX	05/14/2021			
Midstate Energy, LLC, A Veregy Company	Phoenix, AZ	05/14/2021			
Miracle Method of Austin (Nartor Associates Inc)	Austin, TX	05/14/2021			
Morris Boiler Service (JEMDSI, Inc.)	Mercedes, TX	05/14/2021			
MP2 Energy (MP2 Energy Texas LLC)	The Woodlands, TX	05/14/2021	Viewed	06/08/2021	
MRU-Instruments Inc.	Houston, TX	05/14/2021			
MSC Industrial Supply (Sid Tool Co.)	Melville, NY	05/14/2021			
Mtech (Mechanical Technical Services, Inc.)	Austin, TX	05/14/2021			
Nathan Branch	Alpharetta, GA	05/14/2021			
National Glazing Solutions, LLC	Garland, TX	05/14/2021			
NEC co-op energy	Robstown, TX	05/14/2021			
NetworkThermostat (J Drew Inc.)	Grapevine, TX	05/14/2021			
Neutex Advanced Energy Group, Inc	Houston, TX	05/14/2021			
NORESCO	Houston, TX	05/14/2021	Viewed	05/17/2021	
NuEnergen, LLC	White Plains, NY	05/14/2021	Viewed	05/19/2021	
O3 Energy Solutions (O3 Energy LLC)	DALLAS, TX	05/14/2021			
OBELLO, INC	Dallas, TX	05/14/2021			
OfficePro Supply Company LLC	HOUSTON, TX	05/14/2021			
OGH Services, Inc	Houston, TX	05/14/2021			
Ogni Inc	Wood Dale, IL	05/14/2021			
Omega Roofing & Construction	Houston, TX	05/14/2021			
Opal R. Helm, LLC	Houston, TX	05/14/2021			
PANTHEON Advanced Illumination LLC	San Antonio, TX	05/14/2021			
PARADISE AIR (Luck & Logic Inc.)	Kemah, TX	05/14/2021			
PC Specialists Inc. (Technology Integration Group)	San Antonio, TX	05/14/2021			
PCJ Consultants Inc.	Rosharon, TX	05/14/2021			
Pepco Energy Services	Irving, TX	05/14/2021			
Perry Mechanical Service	Edinburg, TX	05/14/2021			
PKJ International LLC	Stafford, TX		Viewed	05/25/2021	
PREMIER & COMPANIES	NEW YORK, NY	05/14/2021			
Premier Wireless	Stafford, TX	05/14/2021			
Preschool Express Learning Academy	Humble, TX	05/14/2021			
Prime Central Store (Waretrack, Inc.)	HOUSTON, TX	05/14/2021			
Principle Information Technology	Houston, TX	05/14/2021			
Pro Tech Mechanical,Inc	Corpus Christi, TX	05/14/2021			
Professional Plastics Inc.	CARROLLTON, TX	05/14/2021			
Prosperity Project Management LLC (N/A)	Washington, DC	05/14/2021	Viewed	05/25/2021	
ProSport Logistics	Springdale, AR	05/14/2021			
Providence Office Products LLC	Conroe, TX	05/14/2021			
Rave Energy	Plano, TX		Submitted	06/10/2021	06/10/2021
RCK Equipment Solutions (Curtis Collins and Katina Collins)	Cleveland, TX	05/14/2021			
RDI Mechanical	Houston, TX	05/14/2021			
Ready Trans Limited Liability Company	Frisco, TX	05/14/2021			
Reflective Energy Solutions	Hackensack, NJ	05/14/2021			
Refrigeration Technologies, LLC	Pottstown, PA	05/14/2021			
Region One ESC	Edinburg, TX	05/14/2021			
Reliant Energy (Reliant Energy Retail Services, LLC)	Houston, TX	05/14/2021	Submitted	06/10/2021	06/10/2021

Renaissance Power Conservation	Norfolk, VA	05/14/2021			
Resource Energy Systems, LLC	Stamford, CT	05/14/2021			
Retro Lighting & Conservation	Sugar Land, TX	05/14/2021			
Ringdale, Inc.	Georgetown, TX	05/14/2021			
Rio Paper & Supply LLC	Pharr, TX	05/14/2021			
RKD Enterprise	Humble, TX	05/14/2021			
Sabari Tech Solutions LLC	Richmond, TX		Viewed	06/09/2021	
Scogin Aire Mehanical (Scogin Aire Mechanical)	Conroe, TX	05/14/2021			
Seahurst Energy Services (Seahurst Electric)	Everett, WA	05/14/2021			
Sempra Energy Solutions	Houston, TX	05/14/2021			
SETEX Facilities & Maintenance, LLC	Beaumont, TX	05/14/2021			
Siemens Industry, Inc	Houston, TX	05/14/2021			
Smith & Company Architects	Stafford, TX	05/14/2021			
Solar Conduit, LLC	San Antonio, TX	05/14/2021			
SourceOne, Inc.	Boston, MA	05/14/2021			
SOUTH TEXAS PUMP INC	WESLACO, TX	05/14/2021			
Spark Power Corp	San Antonio, TX	05/14/2021	Viewed	06/08/2021	
Sparkling Clear Industries	CLUTE, TX	05/14/2021	Viewed	06/08/2021	
SPZ GLOBAL ENERGY LLC	north bergen, NJ	05/14/2021			
Stanley Convergent Security	Houston, TX	05/14/2021			
Stauffer Glove and Safety	Red Hill, PA	05/14/2021			
StoneX Financial Inc.	Lawrence, KS		Viewed	05/17/2021	
Strategic Partnerships, Inc.	Austin, TX	05/14/2021			
Successful Starters Learning Academy II	Houston, TX	05/14/2021			
Summit Electric Supply Co. Inc.	Houston, TX	05/14/2021			
Supply Works (Interline Brands)	Jacksonville, FL	05/14/2021			
Sylvania Lighting Solutions (Sylvania Lighting Services Corp)	Wilmington, MA	05/14/2021			
TD Industries	Dallas, TX	05/14/2021			
Techno Mechanical Solutions, LLC	Austin, TX	05/14/2021			
Texas Art Supply Company	Houston, TX		No Bid	06/08/2021	06/08/2021
Texas Association of African American Chambers of Commerce (TAAACC)	Austin, TX	05/14/2021			
Texas Motor and Control	Waller, TX	05/14/2021			
Texas Solar Resources, Inc.	Friendswood, TX	05/14/2021			
TFC MECHANICAL (TFC Mechanical LLC)	WALLER, TX	05/14/2021			
The Brandt Companies, LLC	Carrollton, TX	05/14/2021			
The Comfort King (Gideon Lynn LLC)	Conroe, TX	05/14/2021			
The Filter Guy	Sunnyvale, TX	05/14/2021			
The Filter Man LLC	New Caney, TX	05/14/2021			
The Green Alliance	Katy, TX	05/14/2021			
The Home Depot	Atlanta, GA	05/14/2021			
The MarketinGroup, LLC	Kingwood, TX	05/14/2021			
The National Behavioral Intervention Team Association	King of Prussia, PA	05/14/2021			
The Reynolds Company	Houston, TX	05/14/2021			
The TEAMS Group, LLC	Austin, TX	05/14/2021			
THG Energy Solutions	Houston, TX	05/14/2021	Viewed	05/14/2021	
Tico Telehealth Inc.	Austin, TX	05/14/2021			
Timilon Corporation	Bonita Springs, FL	05/14/2021			
Tradition Energy	Houston, TX	05/14/2021			
Trane Energy Supply Services (Trane U.S. Inc.)	Carrollton, TX	05/14/2021			
Transcare llc	Houston, TX	05/14/2021			
Turner Power and Construction, LLC (Turner Power Systems and Conctractors, LLC)	Houston, TX	05/14/2021			
TXU Energy	Irving, TX	05/14/2021	Submitted	06/10/2021	06/10/2021
U. S. WHOLESALE PRODUCTS	SAN ANTONIO, TX	05/14/2021			
U.S Electronics recycling Center Inc (Isaac F Sunday)	Houston, TX	05/14/2021			
ULE Group	Hauppauge, NY	05/14/2021			
Unified Sunergy Systems LLC	Flower Mound, TX	05/14/2021			
UniFirst Corporation	Corpus Christi, TX	05/14/2021			
Unify Energy Solutions	Houston, TX	05/14/2021			
Uninex International (Unicorp)	Commerce, CA	05/14/2021			
Ursin's Energy Efficent Lighting,LLC.	Houston, TX	05/14/2021			
Utilities Dynamics Inc.	Paducah, KY	05/14/2021			
Van Brunt & Associates, Inc.	Houston, TX	05/14/2021	Viewed	05/14/2021	

Way Service, Ltd.	Houston, TX	05/14/2021
Whitener Enterprises, Inc	Conroe, TX	05/14/2021
Willbanks & Associates, Inc.	Houston, TX	05/14/2021
Worldwide Power Products	Houston, TX	05/14/2021
Xyple LLC	Round Rock, TX	05/14/2021
Your Pro Medical Inc. (Your Pro Consultant Inc.)	Bedford, TX	05/14/2021
Zenith Designs, LLC	Houston, TX	05/14/2021
Zerimar Lighting Solutions (Ram Ramirez Enterprises Inc.)	McAllen, TX	05/14/2021

---

### External Invitations

Invite Email	Auto Approve	Invitation Date	Status	Status Date
bcovington@mississippi.org	No	05/14/2021	Invitation Sent	05/14/2021
BEP.CMS@Illinois.gov	No	05/14/2021	Invitation Sent	05/14/2021
BusinessDevelopment@dgs.ca.gov	No	05/14/2021	Invitation Sent	05/14/2021
ccanorro@omwbe.wa.gov	No	05/14/2021	Invitation Sent	05/14/2021
Celeste.Metcalf@oa.mo.gov	No	05/14/2021	Invitation Sent	05/14/2021
Charles.Newton@doa.ri.gov	No	05/14/2021	Invitation Sent	05/14/2021
Clarence.Mann@adeca.alabama.gov	No	05/14/2021	Invitation Sent	05/14/2021
davida.manning@admin.sc.gov	No	05/14/2021	Invitation Sent	05/14/2021
deborah.sacra@state.de.us	No	05/14/2021	Invitation Sent	05/14/2021
Dennis.English@doa.nc.gov	No	05/14/2021	Invitation Sent	05/14/2021
DOABDMBD@wisconsin.gov	No	05/14/2021	Invitation Sent	05/14/2021
froseburgh@idoa.in.gov	No	05/14/2021	Invitation Sent	05/14/2021
gs-bmwbo@pa.gov	No	05/14/2021	Invitation Sent	05/14/2021
ida.mcpherson@dembe.virginia.gov	No	05/14/2021	Invitation Sent	05/14/2021
kristiana.j.oliver@wv.gov	No	05/14/2021	Invitation Sent	05/14/2021
Lourdes.Zapata@esd.ny.gov	No	05/14/2021	Invitation Sent	05/14/2021
meg.yetishefsky@ct.gov	No	05/14/2021	Invitation Sent	05/14/2021
mmdhelp.line@state.mn.us	No	05/14/2021	Invitation Sent	05/14/2021
rachel.snell@cpa.state.tx.us	No	05/14/2021	Invitation Sent	05/14/2021
raleigh.lewis@state.or.us	No	05/14/2021	Invitation Sent	05/14/2021
reggie.nunnally@massmail.state.ma.us	No	05/14/2021	Invitation Sent	05/14/2021
rharris@kansascommerce.com	No	05/14/2021	Invitation Sent	05/14/2021
Thad.Fortune@dms.myflorida.com	No	05/14/2021	Invitation Sent	05/14/2021
todd.mcgonigle@das.state.oh.us	No	05/14/2021	Invitation Sent	05/14/2021
TSB@dia.iowa.gov	No	05/14/2021	Invitation Sent	05/14/2021

---

### Participant Detail

#### 1-Stop Enterprises LLC

Address 2640 Deer Hollow Dr. Participation Type: Active Supplier  
Little Elm, TX 75068

Classifications MBE,SBE (Primary),HUB

Invitation Date 05/14/2021  
Invitation Type Automatic  
Invitation Email(s)

#### 2Tier Wholesalers

Address 6022 Jester Drive Participation Type: Active Supplier  
Garland, TX 75044

Classifications MBE,SBE,HUB (Primary),WBE

Invitation Date 05/14/2021  
Invitation Type Automatic  
Invitation Email(s) donnie@2tierwholesaleinc.com

365 Paving & Construction LLC

Address 1618 E. Griffin Parkway Participation Type: Active Supplier  
Mission, TX 78572

Invitation Date 05/14/2021  
Invitation Type Automatic  
Invitation Email(s) 365paving@gmail.com

A C Electric Rental & Sales (Alt Current Electric Rental,LLC)

Address 13825 Lewis Lane Participation Type: Active Supplier  
Montgomery, TX 77316

Classifications WBE (Primary)

Invitation Date 05/14/2021  
Invitation Type Automatic  
Invitation Email(s) amber@acelectricrental.com

A.J.Hurt,Jr.,Inc. dba Reladyne

Address 3310 Alice Street Participation Type: Active Supplier  
Houston, TX 77021

Invitation Date 05/14/2021  
Invitation Type Automatic  
Invitation Email(s) crayton.nelson@reladyne.com

AAA Painting

Address 6005 Westview Rd. Participation Type: Active Supplier  
Houston, TX 77055

Invitation Date 05/14/2021  
Invitation Type Automatic  
Invitation Email(s)

AARACO ENERGY SERVICES (AARACO EXPLORATION, INC.)

Address 6030 Spring Oak Hollow Participation Type: Active Supplier  
Spring, TX 77379, TX 77379

Classifications SBE (Primary)

Invitation Date 05/14/2021  
Invitation Type Automatic  
Invitation Email(s)

AC/DC Synergy Group

Address 623 S. Chestnut St Participation Type: Active Supplier  
Tomball, TX 77375

Classifications WBE (Primary)

Invitation Date 05/14/2021  
Invitation Type Automatic  
Invitation Email(s) dennis.thomas@acdc-sg.com  
Response Date 06/08/2021  
Response Status No Bid  
Status Date 06/08/2021

Acclaim Energy Advisors (Acclaim Energy, Ltd.)

Address Two Riverway, Suite 800 Participation Type: Active Supplier  
Houston, TX 77056

Classifications TCP (Primary)

Invitation Date 05/14/2021  
Invitation Type Automatic  
Invitation Email(s) rholden@acclaimenergy.com



advanced fleet maintenance

---

Address po box 2004  
Cleveland, TX 77328 Participation Type: Active Supplier

Invitation Date 05/14/2021  
Invitation Type Automatic  
Invitation Email(s) richard@afmdpfcleaning.com

Advantage office products

---

Address 5722 Bingle Suite B  
Houston, TX 77092 Participation Type: Active Supplier

Classifications MBE (Primary)

Invitation Date 05/14/2021  
Invitation Type Automatic  
Invitation Email(s)

Advantage Office Products, LLC

---

Address 7513 Benbrook Pkwy, Ste 102  
Benbrook, TX 76126 Participation Type: Active Supplier

Invitation Date 05/14/2021  
Invitation Type Automatic  
Invitation Email(s) dennis@youradvantageonline.com

AEG Affiliated Energy Group

---

Address 2401 Fountain View, Suite 462  
Houston, TX 77057 Participation Type: Active Supplier

Invitation Date 05/14/2021  
Invitation Type Automatic  
Invitation Email(s) abarbeau@affiliatedenergy.com

AES Enterprises

---

Address 64 Ash PL  
New Caney, TX 77357 Participation Type: Active Supplier

Classifications WBE (Primary)

Invitation Date 05/14/2021  
Invitation Type Automatic  
Invitation Email(s) apssupply14@gmail.com

AGH2O Holdings, LLC

---

Address 3817 Bent Brook Drive  
Round Rock, TX 78664 Participation Type: Active Supplier

Invitation Date 05/14/2021  
Invitation Type Automatic  
Invitation Email(s) jlesko@austin.rr.com

Air Comfort, Inc.

---

Address 625 N Main  
Beaumont, TX 77701 Participation Type: Active Supplier

Invitation Date 05/14/2021  
Invitation Type Automatic  
Invitation Email(s) sbabineaux@aircomfort.ac  
Response Status Viewed  
Status Date 06/08/2021

Aleddra (Lightel Technologies, Inc.)

Address 2210 Lind Ave. SW Suite 100 Participation Type: Active Supplier  
Renton, WA 98057

Invitation Date 05/14/2021  
Invitation Type Automatic  
Invitation Email(s) matthew\_maa@aleddra.com

Alexander Development and Leasing Company LLC

Address 1174 REILEY CT Participation Type: Active Supplier  
RACINE, WI 53403

Classifications MBE,SBE,WBE (Primary)

Invitation Date 05/14/2021  
Invitation Type Automatic  
Invitation Email(s) carolyn@alexanderdevlsgcompany.biz

Allied Signs

Address 6820 Harwin Dr. Participation Type: Active Supplier  
Houston, TX 77036

Response Status Viewed  
Status Date 05/28/2021

Alspaugh's Ace Hardware in The Woodlands, LLC

Address 10720 Kuykendahl Rd. Participation Type: Active Supplier  
The Woodlands, TX 77381

Classifications WBE (Primary)

Invitation Date 05/14/2021  
Invitation Type Automatic  
Invitation Email(s) b2b@woodlandsace.net

Alvin Equipment Company

Address 3375 E Highway 6 Participation Type: Active Supplier  
Alvin, TX 77511

Invitation Date 05/14/2021  
Invitation Type Automatic  
Invitation Email(s) chris@alvinequipment.com

Ameresco, Inc.

Address 111 Speen Street Participation Type: Active Supplier  
Framingham, MA 01701

Classifications TCP (Primary),TIP

Invitation Date 05/14/2021  
Invitation Type Automatic  
Invitation Email(s) grash@ameresco.com rgeorgeoff@ameresco.com sprice@ameresco.com vdrieling@ameresco.com  
wmccord@ameresco.com dallums@ameresco.com cnobles@ameresco.com  
Response Status Viewed  
Status Date 06/08/2021

Amerex Energy Services (Amerex Brokers LLC)

Address One Sugar Creek Center Blvd. Participation Type: Active Supplier  
Sugar Land, TX 77478

Invitation Date 05/14/2021  
Invitation Type Automatic  
Invitation Email(s) celliott@amerexenergy.com  
Response Status Viewed  
Status Date 05/19/2021

AMERICAN FLOORING SERVICES

---

Address 310 Morton Street Suite 357 Participation Type: Active Supplier  
Richmond, TX 77469

Invitation Date 05/14/2021  
Invitation Type Automatic  
Invitation Email(s) msmith7449@comcast.net

AMERICAN MADE SOLAR AND WIND (MARDEL SOUZA INC)

---

Address 4255 OLD HWY 77 Participation Type: Active Supplier  
BROWNSVILLE, TX 78520

Classifications MBE (Primary),TAS,HUB

Invitation Date 05/14/2021  
Invitation Type Automatic  
Invitation Email(s) alexpena@ausasolar.com

AMS Electric Inc.

---

Address 1038 W 23rd St. Participation Type: Active Supplier  
Tempe, AZ 85282

Invitation Date 05/14/2021  
Invitation Type Automatic  
Invitation Email(s)

Anderson Hydra Platforms, Inc.

---

Address 7703 Park Place Rd Participation Type: Active Supplier  
York, SC 29745

Invitation Date 05/14/2021  
Invitation Type Automatic  
Invitation Email(s) cyndi@inspectabridge.com

Aramark Management Services Limited Partnership (Aramark SMMS LLC)

---

Address 2400 Market Street Participation Type: Active Supplier  
Philadelphia, PA 19103

Invitation Date 05/14/2021  
Invitation Type Automatic  
Invitation Email(s) growth@aramark.com

ATViroTech Inc.

---

Address 1918 Mackenzie Way Participation Type: Active Supplier  
Missouri City, TX 77489

Classifications MBE (Primary),SBE,HUB

Invitation Date 05/14/2021  
Invitation Type Automatic  
Invitation Email(s) altownsend@atvirotech.com

Bath Fitter

---

Address 5911 Rittiman Plaza #2 Participation Type: Active Supplier  
San Antonio, TN 78218

Invitation Date 05/14/2021  
Invitation Type Automatic  
Invitation Email(s) wnewberry@bathfitter.com

Batteries Plus Bulbs #468 (Kingdom Alliance,LLC)

Address 528 S Mason  
Katy, TX 77450 Participation Type: Active Supplier

Classifications SBE (Primary),WBE

Invitation Date 05/14/2021  
Invitation Type Automatic  
Invitation Email(s) sales774@batteriesplus.net

Batteries Plus Bulbs, Humble (Shookalot, Inc.)

Address 9477 FM 1960 Bypass Rd W  
Humble, TX 77338 Participation Type: Active Supplier

Classifications SBE (Primary)

Invitation Date 05/14/2021  
Invitation Type Automatic  
Invitation Email(s) sam.shook@batteriesplus.com

BEASLEY TIRE SERVICE, INC

Address 11802 EASTEX FRWY  
HOUSTON, TX 77039 Participation Type: Active Supplier

Classifications TXM (Primary)

Invitation Date 05/14/2021  
Invitation Type Automatic  
Invitation Email(s) b davidson@beasleytire.com gtrevino@beasleytire.com

Bee (Nodal Partners)

Address 13640 Briarwick Dr., Suite 180  
Austin, TX 78729 Participation Type: Active Supplier

Classifications MBE, TXM, SBE (Primary), HUB

Invitation Date 05/14/2021  
Invitation Type Automatic  
Invitation Email(s)

BenchMark Facility Solutions, LLC

Address 5050 Quorum Drive, Suite 700, #147  
Dallas, TX 75254-1410 Participation Type: Active Supplier

Classifications SBE (Primary)

Invitation Date 05/14/2021  
Invitation Type Automatic  
Invitation Email(s) brian.jones@bfsmanagement.com

Bernhard (Bernhard MCC LLC)

Address 4888 Loop Central Drive  
Houston, TX 77081 Participation Type: Active Supplier

Invitation Date 05/14/2021  
Invitation Type Automatic  
Invitation Email(s) rbalentine@bernhardmcc.com

Better Efficiency Solutions and Technologies

Address 1401 Terrapin, Ste. B  
Austin, TX 78746 Participation Type: Active Supplier

Classifications SBE (Primary)

Invitation Date 05/14/2021  
Invitation Type Automatic  
Invitation Email(s) howard.cleaver@betterefficientsolutions.com

Beyond Controls Inc.

Address 12036 Windfern Rd  
Houston, TX 77064 Participation Type: Active Supplier

Invitation Date 05/14/2021  
Invitation Type Automatic  
Invitation Email(s) gbalentine@beyondcontrols.com

BidDesk Analytics

Address 4 Beaver Brook Rd  
Lincoln Park, NJ 07035 Participation Type: Active Supplier

Invitation Date 05/14/2021  
Invitation Type Automatic  
Invitation Email(s) jw@biddesk.com

BioSafe Systems, LLC

Address 22 Meadow Street  
East Hartford, CT 06108 Participation Type: Active Supplier

Invitation Date 05/14/2021  
Invitation Type Automatic  
Invitation Email(s)

Blackland Glass & Construction

Address 120 Taylor Plaza Drive  
Greenville, TX 75402 Participation Type: Active Supplier

Invitation Date 05/14/2021  
Invitation Type Automatic  
Invitation Email(s) billy@blacklandglass.com

Bocci Engineering, LLC

Address 12709 Pine Drive  
Cypress, TX 77429 Participation Type: Active Supplier

Invitation Date 05/14/2021  
Invitation Type Automatic  
Invitation Email(s) marketing\_bid\_notice@bocciengineering.com

Bolo Stick LLC

Address PO Box 8626  
Warren, OH 44484 Participation Type: Active Supplier

Invitation Date 05/14/2021  
Invitation Type Automatic  
Invitation Email(s) bill@bolostick.net

Brahmarsk Corporation

Address 19901 SOUTHWEST FREEWAY #305  
Sugar Land, TX 77479 Participation Type: Active Supplier

Invitation Date 05/14/2021  
Invitation Type Automatic  
Invitation Email(s) sri@brahmarsk.com

BRB Supply

Address 11807 Catalpa Circle  
Houston, TX 77065 Participation Type: Active Supplier

Classifications MBE,SBE,HUB (Primary)

Invitation Date 05/14/2021  
Invitation Type Automatic  
Invitation Email(s) brbsupply@swbell.net

Briar Patch

Address 12283-A Veterans Memorial Dr. Participation Type: Active Supplier  
Houston, TX 77067

Classifications MBE (Primary),SBE,WBE

Invitation Date 05/14/2021  
Invitation Type Automatic  
Invitation Email(s) tpensonwilson@yahoo.com

Brooke's Learning Corner LLC.

Address 8431 Bigwood st Participation Type: Active Supplier  
houston, TX 77078

Classifications MBE (Primary)

Invitation Date 05/14/2021  
Invitation Type Automatic  
Invitation Email(s) brookeslearningcorner@gmail.com

BTM SOLUTIONS LLC

Address 9450 Pincroft Drive # 7030 Participation Type: Active Supplier  
The Woodlands, TX 77387

Invitation Date 05/14/2021  
Invitation Type Automatic  
Invitation Email(s)

BUDGET RESTAURANT SUPPLY (TAI HING CORPORATION)

Address 8800 W. Sam Houston Parkway So. Participation Type: Active Supplier  
Houston, TX 77099

Classifications MBE (Primary),HUB

Invitation Date 05/14/2021  
Invitation Type Automatic  
Invitation Email(s) fawn.griffin@budgetrs.com

Building Material Supply, Inc.

Address 13492 Research Blvd; Suite 120 - #688 Participation Type: Active Supplier  
Austin, TX 78750

Invitation Date 05/14/2021  
Invitation Type Automatic  
Invitation Email(s) cstevens@bmsizone.com

Building Optimization Technologies

Address 800 Wilcrest Dr Participation Type: Active Supplier  
Houston, TX 77042

Invitation Date 05/14/2021  
Invitation Type Automatic  
Invitation Email(s) jmitterhofer@bldgot.com

C&L Consulting

Address 3514 Wentworth Street Participation Type: Active Supplier  
Houston, TX 77004

Classifications MBE (Primary),SBE,HUB,WBE

Invitation Date 05/14/2021  
Invitation Type Automatic  
Invitation Email(s)

C&W Electric Supply (CRAWFORD AND WILSON ENTERPRISES INC.)

---

Address 1251 Industrial Blvd. Suite A Participation Type: Active Supplier  
Plano, TX 75074

Classifications SBE (Primary),HUB,WBE

Invitation Date 05/14/2021  
Invitation Type Automatic  
Invitation Email(s) cwelectric@att.net

---

Capitol Air Conditioning Services (Capitol Air Conditioning Services LLC,)

Address PO Box 5085 Participation Type: Active Supplier  
Georgetown, TX 78627

Classifications WBE (Primary)

Invitation Date 05/14/2021  
Invitation Type Automatic  
Invitation Email(s) jeandavis2@verizon.net

---

Caprock Electric

Address 900 Hogan Participation Type: Active Supplier  
Houston, TX 77009

Classifications SBE,HUB,WBE (Primary)

Invitation Date 05/14/2021  
Invitation Type Automatic  
Invitation Email(s) joshlovoi@caprockelectric.com

---

Catalyst PR INC

Address 1701 N Thompson St Participation Type: Active Supplier  
Conroe, TX 77301-1989

Classifications SBE,HUB (Primary),WBE

Invitation Date 05/14/2021  
Invitation Type Automatic  
Invitation Email(s) holly@catalystpr.net

---

CB Solutions LP

Address 20811 Dawn Dr. #905 Participation Type: Active Supplier  
Lago Vista, TX 78645

Invitation Date 05/14/2021  
Invitation Type Automatic  
Invitation Email(s) connor@cbsolutionslp.com

---

CDM Contracting Services

Address 175 Duncan Road Participation Type: Active Supplier  
Brownsville, TX 78526

Invitation Date 05/14/2021  
Invitation Type Automatic  
Invitation Email(s) cdm174@sbcglobal.net

---

Child Care Associates

Address 3000 E BELKNAP ST Participation Type: Active Supplier  
FORT WORTH, TX 76111-4142

Invitation Date 05/14/2021  
Invitation Type Automatic  
Invitation Email(s) patricia.looper@childcareassociates.org

Choice! Energy Services Retail, LP

Address 5151 San Felipe St  
Houston, TX 77056 Participation Type: Active Supplier

Classifications MBE,TCP

Invitation Date 05/14/2021

Invitation Type Automatic

Invitation Email(s) jes@choiceenergyservices.com osting.t@choiceenergymgt.com Jones.l@choiceenergymgt.com  
Sisson.j@choiceenergymgt.com

Response Date 05/14/2021

Response Status No Bid

Status Date 05/14/2021

cleaningessence LLC

Address 19716 SAUMS RD  
HOUSTON, TX 77084 Participation Type: Active Supplier

Classifications SBE (Primary)

Invitation Date 05/14/2021

Invitation Type Automatic

Invitation Email(s) john.taylor@cleaningessence.com

Climatec LLC

Address 7240 Brittmoore  
Houston, TX 77041 Participation Type: Active Supplier

Invitation Date 05/14/2021

Invitation Type Automatic

Invitation Email(s) lwestbrook@climatec.com tcrittenden@climatec.com

Response Status Viewed

Status Date 05/24/2021

Coastal Air Balance Corp.

Address 1005 Harimaw CT. West STE 102  
Metairie, LA 70001 Participation Type: Active Supplier

Invitation Date 05/14/2021

Invitation Type Automatic

Invitation Email(s) john@coastalabcorp.com

Combined Refrigeration Resources, Inc.

Address 1118 1st Street East  
Humble, TX 77338 Participation Type: Active Supplier

Invitation Date 05/14/2021

Invitation Type Automatic

Invitation Email(s) service@combinedrefrigeration.com

Comflow Mechanical Services

Address 6411 Lawford Lane  
Houston, TX 77040 Participation Type: Active Supplier

Invitation Date 05/14/2021

Invitation Type Automatic

Invitation Email(s) cevett@comflowco.com

Computer Station Corporation

Address 6611 Bissonnet St.  
Houston, TX 77074 Participation Type: Active Supplier

Classifications MBE,HUB,WBE (Primary)

Invitation Date 05/14/2021

Invitation Type Automatic

Invitation Email(s) cpbid@computerstationcorp.com



Computrols of Texas (Computrols, Inc)

---

Address 2520 Belle Chasse Highway Gretna, LA 70053 Participation Type: Active Supplier

Invitation Date 05/14/2021  
Invitation Type Automatic  
Invitation Email(s) Engineering@Computrols.com

ConEd Solutions (Consolidated Edison Solutions, Inc.)

---

Address 1900 West Loop South Houston, TX 77027 Participation Type: Active Supplier

Invitation Date 05/14/2021  
Invitation Type Automatic  
Invitation Email(s) longb@conedsolutions.com

Conservation Station

---

Address 60 Sun Forest Way Chapel Hill, NC 27857 Participation Type: Active Supplier

Classifications SBE (Primary),HUB,WBE

Invitation Date 05/14/2021  
Invitation Type Automatic  
Invitation Email(s) doreen@conservationstation.net

Constellation Energy (Constellation NewEnergy, Inc.)

---

Address 1221 Lamar Street Houston, TX 77010 Participation Type: Active Supplier

Classifications HGA (Primary)

Invitation Date 05/14/2021  
Invitation Type Automatic  
Invitation Email(s)

Control Products (C.P. Distributors LLP)

---

Address 9101 Jameel Rd. Suite 130 Houston, TX 77040 Participation Type: Active Supplier

Invitation Date 05/14/2021  
Invitation Type Automatic  
Invitation Email(s) debbiev@control-products.cc

Control Specialties

---

Address 2503 Monroe Drive Gainesville, GA 30507 Participation Type: Active Supplier

Classifications WBE (Primary)

Invitation Date 05/14/2021  
Invitation Type Automatic  
Invitation Email(s) margie@control-specialties.com

Convergentz (Greens Road B, LLC)

---

Address 10555 Westpark Drive Houston, TX 77042 Participation Type: Active Supplier

Classifications TCP (Primary)

Invitation Date 05/14/2021  
Invitation Type Automatic  
Invitation Email(s) avasquez@convergentz.com RBalentine@convergentz.com

Cotton Commercial USA

Address 5443 Katy Hockley Cutoff  
Katy, TX 77493 Participation Type: Active Supplier

Classifications HGA (Primary),TCP,TPA

Invitation Date 05/14/2021  
Invitation Type Automatic  
Invitation Email(s) jennifer.fox@cottonteam.com

Council Rock Enterprises, LLC

Address 11 Centre Park  
Rochester, NY 14614 Participation Type: Active Supplier

Classifications MBE,SBE,HUB (Primary)

Invitation Date 05/14/2021  
Invitation Type Automatic  
Invitation Email(s)

Crawford Electric Supply Co.

Address 7390 Northcourt Road  
Houston, TX 77040 Participation Type: Active Supplier

Classifications TAS (Primary)

Invitation Date 05/14/2021  
Invitation Type Automatic  
Invitation Email(s) Anthony.Merola@crawfordelectricsupply.com chogan@crawfordelectricsupply.com  
mfont@crawfordelectricsupply.com jwells@crawfordelectricsupply.com

Custom Air Products & Services, Inc.

Address 35 Southbelt Industrial Dr  
Houston, TX 77047 Participation Type: Active Supplier

Invitation Date 05/14/2021  
Invitation Type Automatic  
Invitation Email(s) Bea.amaya@customairproducts.com corrie.haines@customairproducts.com  
susan.archer@customairproducts.com

CVAL Innovations (CVAL Innovations LLC)

Address 9701 Raven Ln  
Irving, TX 75063 Participation Type: Active Supplier

Invitation Date 05/14/2021  
Invitation Type Automatic  
Invitation Email(s) info@cvalinnovations.com

Cyclone FPV (Cyclone 3D, Inc.)

Address 5546 Silent Timber Path LN.  
Spring, TX 77386 Participation Type: Active Supplier

Response Status Viewed  
Status Date 05/16/2021

Cy-Fair Tire (Keilers Holdings, Inc.)

Address 3201 Texas 36 South  
Brenham, TX 77833 Participation Type: Active Supplier

Response Date 06/08/2021  
Response Status No Bid  
Status Date 06/08/2021

D & R Electric Company

Address 1430 N. Flores  
San Antonio, TX 78212 Participation Type: Active Supplier

Classifications MBE,TAS,SBE (Primary),HUB,WBE

Invitation Date 05/14/2021  
Invitation Type Automatic  
Invitation Email(s) debbie.dnrelectric@yahoo.com

Dalkia Energy Solutions

Address 200 Cummings Center, 177-C  
Beverly, MA 01915 Participation Type: Active Supplier

Invitation Date 05/14/2021  
Invitation Type Automatic  
Invitation Email(s) jc.florenson@dalkiasolutions.com

Danny's Laundry Service

Address 1001 Burke #B  
Pasadena, TX 77506 Participation Type: Active Supplier

Invitation Date 05/14/2021  
Invitation Type Automatic  
Invitation Email(s) texlaundry@yahoo.com

Dataprobe Inc.

Address 1-B Pearl Court  
Allendale, NJ 07401 Participation Type: Active Supplier

Classifications SBE (Primary)

Invitation Date 05/14/2021  
Invitation Type Automatic  
Invitation Email(s) dvolkov@dataprobe.com

Delta Air Conditioning and Heating LLC

Address 9612 Westpark Drive  
Houston, TX 77063 Participation Type: Active Supplier

Classifications SBE (Primary)

Invitation Date 05/14/2021  
Invitation Type Automatic  
Invitation Email(s) deltaac2000@yahoo.com

Demand Lighting USA, Inc.

Address 8027 Exchange Dr  
Austin, TX 78754 Participation Type: Active Supplier

Classifications SBE (Primary),HUB,WBE

Invitation Date 05/14/2021  
Invitation Type Automatic  
Invitation Email(s) matthewrubino@demandlighting.com garymorrissey@demandlighting.com

DGR United

Address 6402 Oaknut Dr  
houston, TX 77088 Participation Type: Active Supplier

Classifications MBE (Primary),SBE,HUB

Invitation Date 05/14/2021  
Invitation Type Automatic  
Invitation Email(s) info@dgrunited.com

Direct Energy

Address 12 Greenway Plaza  
Houston, TX 77046 Participation Type: Active Supplier

Response Status Viewed  
Status Date 06/07/2021

Duran Industries Inc.

Address 504 Business Parkway  
Richardson, TX 75081 Participation Type: Active Supplier

Classifications MBE (Primary),SBE,HUB

Invitation Date 05/14/2021  
Invitation Type Automatic  
Invitation Email(s) jduran@duranco.com

Eaton (Eaton Corporation)

Address 5800 Cross Park Drive  
Austin, TX 78746 Participation Type: Active Supplier

Classifications TXM (Primary)

Invitation Date 05/14/2021  
Invitation Type Automatic  
Invitation Email(s)

Educational Systems Consulting

Address 60 Victoria Drive  
Binghamton, NY 13904 Participation Type: Active Supplier

Invitation Date 05/14/2021  
Invitation Type Automatic  
Invitation Email(s) consult@edsystemsconsulting.org

EL PASO BOLT & SCREW CO., INC

Address 7058 Alameda Ave  
El Paso, TX 79915 Participation Type: Active Supplier

Classifications MBE (Primary),HUB

Invitation Date 05/14/2021  
Invitation Type Automatic  
Invitation Email(s) elpasobolt1@gmail.com

Electrical Distributors LLC

Address 6399 Windfern  
Houston, TX 77040 Participation Type: Active Supplier

Classifications TAS,SBE (Primary)

Invitation Date 05/14/2021  
Invitation Type Automatic  
Invitation Email(s) pchiozza@ed-tx.com

Elite Water and Coffee

Address 710 Ridgewood Road  
Ridgeland, MS 39157 Participation Type: Active Supplier

Invitation Date 05/14/2021  
Invitation Type Automatic  
Invitation Email(s)

E-Logic, Inc.

---

Address 1025 Connecticut Avenue NW Participation Type: Active Supplier  
Washington, DC 20036

Invitation Date 05/14/2021  
Invitation Type Automatic  
Invitation Email(s) LPadilla@e-logic.us

Empowered Network Services, LLC

---

Address 27406 Farmcreek Drive Participation Type: Active Supplier  
Huffman, TX 77336

Invitation Date 05/14/2021  
Invitation Type Automatic  
Invitation Email(s) tom@empowerednetwork.us

Energy Saving Advisor Distributors

---

Address P.O.BOX131943 Participation Type: Active Supplier  
Dallas, TX 75313

Invitation Date 05/14/2021  
Invitation Type Automatic  
Invitation Email(s) Support@TelecomMNC.com  
Response Status Viewed  
Status Date 05/17/2021

Epic Solar Control, LLC

---

Address 180 Industrial Blvd Ste R Participation Type: Active Supplier  
Mckinney, TX 75069

Response Status Viewed  
Status Date 06/01/2021

Evco Partners LP dba Burgoon Company

---

Address PO Box 1168 Participation Type: Active Supplier  
Galveston, TX 77553

Invitation Date 05/14/2021  
Invitation Type Automatic  
Invitation Email(s) office@burgooncompany.com

Evertek LLC

---

Address 159 Main St Participation Type: Active Supplier  
Flemington, NJ 08822

Classifications SBE,WBE (Primary)

Invitation Date 05/14/2021  
Invitation Type Automatic  
Invitation Email(s) ceo@evertekllc.com

ExerPlay, Inc

---

Address 12220 N Hwy 14, Suite 5 Participation Type: Active Supplier  
Cedar Crest, NM 87008

Invitation Date 05/14/2021  
Invitation Type Automatic  
Invitation Email(s) vicki@exerplay.com

FACILITIES INTEGRATED SOLUTIONS & CONSULTING LLC

---

Address 21145 FM 529 SUITE 1114 Participation Type: Active Supplier  
CYPRESS, TX 77433

Classifications MBE,HUB (Primary),WBE

Invitation Date 05/14/2021  
Invitation Type Automatic  
Invitation Email(s) nhamler@fiscllc.com

Facility Response Group

---

Address 100 Crescent Ct #700 Ste Participation Type: Active Supplier  
Dallas, TX 75201

Invitation Date 05/14/2021  
Invitation Type Automatic  
Invitation Email(s)

Facility Solutions Group

---

Address 5091 Steadmont Dr Participation Type: Active Supplier  
houston, TX 77040

Invitation Date 05/14/2021  
Invitation Type Automatic  
Invitation Email(s) Briand@fsgi.com

Fastenal Company

---

Address 2001 Theurer Blvd Participation Type: Active Supplier  
Winona, MN 55987

Invitation Date 05/14/2021  
Invitation Type Automatic  
Invitation Email(s) afolkers@fastenal.com

Flicgroup (Federal lighting illumination capital)

---

Address 1256 Main Street Participation Type: Active Supplier  
Southlake, TX 76092

Classifications SBE (Primary)

Invitation Date 05/14/2021  
Invitation Type Automatic  
Invitation Email(s) J.sheehan@flicgroup.com

Fors Lux Group (Fors Lux Group Corporation)

---

Address 2425 W. Loop South Participation Type: Active Supplier  
Houston, TX 77027

Invitation Date 05/14/2021  
Invitation Type Automatic  
Invitation Email(s) c.ashmeade@forsluxgroup.com

Franklin D Saulsberry LLC

---

Address 19078 Larry Wayne St Participation Type: Active Supplier  
Porter, TX 77365

Classifications MBE (Primary),SBE,HUB

Response Status Viewed  
Status Date 05/22/2021

G&E Industrial Supplies Inc.

Address 857 Pendale Rd  
El Paso, TX 79907 Participation Type: Active Supplier

Classifications HUB (Primary)

Invitation Date 05/14/2021  
Invitation Type Automatic  
Invitation Email(s) john@geindustrialsupplies.com  
Response Status Viewed  
Status Date 05/14/2021

G4C Enterprises, LLC

Address P.O. Box 1272  
Pflugerville, TX 78691 Participation Type: Active Supplier

Classifications MBE,SBE,HUB (Primary)

Response Status Viewed  
Status Date 05/23/2021

Gazelle Capital, LLC

Address 6785 58TH AVE N  
Saint Petersburg, FL 33709 Participation Type: Active Supplier

Classifications SBE (Primary)

Invitation Date 05/14/2021  
Invitation Type Automatic  
Invitation Email(s) bids@gazelle.capital

GDF Suez Energy Resources NA

Address 1990 Post Oak Blvd., Suite 1900  
Houston, TX 77056 Participation Type: Active Supplier

Invitation Date 05/14/2021  
Invitation Type Automatic  
Invitation Email(s)

Geaux Crates & Storage, LLC

Address 14504 North Freeway  
Houston, TX, TX 77090 Participation Type: Active Supplier

Invitation Date 05/14/2021  
Invitation Type Automatic  
Invitation Email(s) kerry@geauxcrates.com

Gene's Machine, INC.

Address 235 Leeper Lane  
Victoria, TX 77904 Participation Type: Active Supplier

Invitation Date 05/14/2021  
Invitation Type Automatic  
Invitation Email(s) mattapodackis@genesmachine.com

GermBlast (Infection Controls, Inc.)

Address 1414 Avenue J  
Lubbock, TX 79401 Participation Type: Active Supplier

Invitation Date 05/14/2021  
Invitation Type Automatic  
Invitation Email(s) wes@germblast.com kroye@germblast.com

GermWrap

Address 499 Pecan Forest  
New Braunfels, TX 78130 Participation Type: Active Supplier

Invitation Date 05/14/2021  
Invitation Type Automatic  
Invitation Email(s) marcos@germwrap.com  
Response Status Viewed  
Status Date 05/14/2021

GH Mechanical and Services LLC

Address 6321 Theall Road  
Houston, TX 77066 Participation Type: Active Supplier

Classifications MBE (Primary),SBE

Invitation Date 05/14/2021  
Invitation Type Automatic  
Invitation Email(s) kaidoo@thesquarebutton.com rguajardo@ghmech.com sgieseler@thesquarebutton.com

Gilbarco Inc.

Address 7300 West Friendly Ave.  
Greensboro, NC 27410 Participation Type: Active Supplier

Invitation Date 05/14/2021  
Invitation Type Automatic  
Invitation Email(s) allen.goetz@gilbarco.com

GMP Media Group

Address 534 Pryor Street  
Atlanta, GA 30312 Participation Type: Active Supplier

Invitation Date 05/14/2021  
Invitation Type Automatic  
Invitation Email(s) gromoeprod@gmail.com

Good Faith Energy

Address 1300 E Arapaho suite 201  
Richardson, TX 75081 Participation Type: Active Supplier

Classifications SBE (Primary)

Invitation Date 05/14/2021  
Invitation Type Automatic  
Invitation Email(s) michael@goodfaithenergy.com

Gray Mechanical (Gray Mechanical, LLC)

Address 15534 West Hardy Rd. Ste. 100  
Houston, TX 77060 Participation Type: Active Supplier

Invitation Date 05/14/2021  
Invitation Type Automatic  
Invitation Email(s) jody.vowell@graymechanical.com

Graybar Electric Company, Inc.

Address 6161 Bingle Rd  
Houston, TX 77092 Participation Type: Active Supplier

Classifications DIR (Primary),USC

Invitation Date 05/14/2021  
Invitation Type Automatic  
Invitation Email(s)



Gruber Power Services (Gruber Technical Inc.)

Address 21439 North 2nd Avenue Participation Type: Active Supplier  
Phoenix, AZ 85027

Invitation Date 05/14/2021  
Invitation Type Automatic  
Invitation Email(s)

GSI Highway

Address 2861 S Beltline Rd Participation Type: Active Supplier  
Dallas, TX 75253

Classifications SBE (Primary)

Invitation Date 05/14/2021  
Invitation Type Automatic  
Invitation Email(s) valeriec@gsihighway.com

Gulf Coast Nut & Bolt LLC

Address 4501 Leopard st Participation Type: Active Supplier  
Corpus Christi, TX 78408

Invitation Date 05/14/2021  
Invitation Type Automatic  
Invitation Email(s) Paul@gcnbolt.com

Gulf States Laundry Machinery

Address 12647 Memorial Drive Participation Type: Active Supplier  
Houston, TX 77024

Invitation Date 05/14/2021  
Invitation Type Automatic  
Invitation Email(s) laundrylady2015@gmail.com

Gulftex (B J Interest, Inc.)

Address 7710 Cherry Park Dr., Suite T-425 Participation Type: Active Supplier  
Houston, TX 77095

Classifications SBE (Primary)

Invitation Date 05/14/2021  
Invitation Type Automatic  
Invitation Email(s) billt@gulftex92.com

Haynes Mechanical Systems, Inc.

Address 5700 S Quebec St. Participation Type: Active Supplier  
Greenwood Village, CO 80111

Classifications SBE (Primary)

Invitation Date 05/14/2021  
Invitation Type Automatic  
Invitation Email(s) tpekalski@haynesmechanical.com

Heat Transfer Solutions (HTS Texas)

Address 3350 Yale Street Participation Type: Active Supplier  
Houston, TX 77018

Invitation Date 05/14/2021  
Invitation Type Automatic  
Invitation Email(s) Tarynbeth.pilutti@hts.com todd.mccullough@hts.com kelley.barrett@hts.com eric.swilley@hts.com  
jason.mitchell@hts.com

Herc Rentals

Address 3920 North Freeway Participation Type: Active Supplier  
Houston, TX 77022

Invitation Date 05/14/2021  
Invitation Type Automatic  
Invitation Email(s) avery.braggs@hercrentals.com

Hercules Poly

Address 315 Main St Participation Type: Active Supplier  
Eclectic, AL 36024

Invitation Date 05/14/2021  
Invitation Type Automatic  
Invitation Email(s) thelington@herculespoly.com

Heritage Institute of Sustainability LLC

Address 15707C Coit Rd. Suite 133 Participation Type: Active Supplier  
Dallas, TX 75248

Invitation Date 05/14/2021  
Invitation Type Automatic  
Invitation Email(s) info@heritageios.com

Hill Country Computer (HCC)

Address 791 N Highway 77 Participation Type: Active Supplier  
Waxahachie, TX 75165

Classifications SBE (Primary)

Invitation Date 05/14/2021  
Invitation Type Automatic  
Invitation Email(s) webmaster@hillcountrycomputer.com

Honesty Construction Group (HCG Management LLC)

Address 3102 Brahman Dr Participation Type: Active Supplier  
Manvel, TX 77578

Classifications MBE (Primary),SBE,HUB

Invitation Date 05/14/2021  
Invitation Type Automatic  
Invitation Email(s) gregw@honestycg.com julie@juliehartman.com

Hoodz of Greater Houston & College Station (SparkySpark Inc)

Address 183 Wade Pointe DR Participation Type: Active Supplier  
Montgomery, TX 77316

Invitation Date 05/14/2021  
Invitation Type Automatic  
Invitation Email(s) dan.langdon@hoodz.us.com

Hou-Tex Glass & Mirror Co (Hou Tex Newnom Inc.)

Address 1153 Brittmoore Rd Participation Type: Active Supplier  
Houston, TX 77043

Invitation Date 05/14/2021  
Invitation Type Automatic  
Invitation Email(s) rick@houtexglass.com

Hunton Services (HVAC Mechanical Services of Texas LTD)

Address 5622 Luce Street Participation Type: Active Supplier  
Houston, TX 77087

Classifications TCP (Primary)

Invitation Date 05/14/2021  
Invitation Type Automatic  
Invitation Email(s) blecompte@huntongroup.com khardin@huntongroup.com smixon@huntongroup.com  
saguiar@huntongroup.com

I/S Mechanical (Inno/lution)

Address 29811 Spring Acres Participation Type: Active Supplier  
Spring, TX 77386

Classifications MBE (Primary),WBE

Invitation Date 05/14/2021  
Invitation Type Automatic  
Invitation Email(s) brandon.markgraf@gmail.com

Indatatech (Instant Data Technologies, Inc.)

Address 85 NE Loop 410 Participation Type: Active Supplier  
San Antonio, TX 78216

Classifications MBE,SBE (Primary)

Invitation Date 05/14/2021  
Invitation Type Automatic  
Invitation Email(s) bramcharan@indatatech.com brivera@indatatech.com

INFINITY CONTRACTORS INT'L LTD

Address 2563 E LOOP 820 N Participation Type: Active Supplier  
FORT WORTH, TX 76118

Invitation Date 05/14/2021  
Invitation Type Automatic  
Invitation Email(s) JBSALTER@INFINITYCONTRACTORS.COM

Influent Energy (Distributed Generation and Storage, LLC)

Address PO Box 412034 Participation Type: Active Supplier  
Kansas City, MO 64141

Invitation Date 05/14/2021  
Invitation Type Automatic  
Invitation Email(s) accounting@influentenergy.com  
Response Status Viewed  
Status Date 05/14/2021

Information & Energy Services, Inc.

Address 1306 Gulfstream St. Participation Type: Active Supplier  
Pleasanton, CA 94588

Invitation Date 05/14/2021  
Invitation Type Automatic  
Invitation Email(s) jase@iesenergy.com

Interstate All Battery Center (Interstate Battery)

Address 1301 W GLADE RD STE 156 Participation Type: Active Supplier  
EULESS, TX 76039

Invitation Date 05/14/2021  
Invitation Type Automatic  
Invitation Email(s) Eulesstx@ibsa.com

ISC Sales, Inc.

Address 4421 Tradition Trail  
Plano, TX 75093 Participation Type: Active Supplier

Invitation Date 05/14/2021  
Invitation Type Automatic  
Invitation Email(s) iscinfo@iscsales.com

J&H Energy Consultants

Address 5811 Tidewater Dr.  
Houston, TX 77085 Participation Type: Active Supplier

Classifications MBE (Primary),SBE,HUB

Invitation Date 05/14/2021  
Invitation Type Automatic  
Invitation Email(s) harlishahomer@jhenergyconsultants.com  
Response Status Viewed  
Status Date 05/14/2021

JAVACCS, LLC

Address 9473 Fm 1960 West Suite 100  
Humble, TX 77338 Participation Type: Active Supplier

Classifications MBE (Primary),SBE,WBE

Invitation Date 05/14/2021  
Invitation Type Automatic  
Invitation Email(s) johnson2va@gmail.com

JEGAS Construction

Address PO Box 25183  
Houston, TX 77265 Participation Type: Active Supplier

Invitation Date 05/14/2021  
Invitation Type Automatic  
Invitation Email(s)

Jet Industrial Service Group

Address 23264 IH 10  
Vidor, TX 77662 Participation Type: Active Supplier

Invitation Date 05/14/2021  
Invitation Type Automatic  
Invitation Email(s) c.townley@jetisg.com

Jorrie Martin LLC

Address 4407 Walzem Road, Suite 210  
San Antonio, TX 78218 Participation Type: Active Supplier

Classifications MBE,SBE (Primary)

Invitation Date 05/14/2021  
Invitation Type Automatic  
Invitation Email(s)

kaizen Renewable Energy (kaizen Endeavors, Inc.)

Address 6060 N. Central Expressway  
Dallas, TX 75206 Participation Type: Active Supplier

Classifications MBE,SBE (Primary),HUB,WBE

Invitation Date 05/14/2021  
Invitation Type Automatic  
Invitation Email(s) lmr@kaizenrenewableenergy.com

KANKO (Floyd's Chores & Odd Jobs)

Address 2031 Cedar Valley  
Dallas, TX 75232 Participation Type: Active Supplier

Invitation Date 05/14/2021  
Invitation Type Automatic  
Invitation Email(s) kankobidops@gmail.com

Kentech Inc.

Address 21855 E. Hammond Dr.  
Porter, TX 77365 Participation Type: Active Supplier

Classifications HGA,HUB,WBE (Primary)

Invitation Date 05/14/2021  
Invitation Type Automatic  
Invitation Email(s) bthompson@kentechpower.com  
Response Date 06/08/2021  
Response Status No Bid  
Status Date 06/08/2021

Koch Filter Corporation

Address 8401 Air Commerce Drive  
Louisville, KY 40219 Participation Type: Active Supplier

Invitation Date 05/14/2021  
Invitation Type Automatic  
Invitation Email(s)

L&S Associates, LLC

Address 135 Victoria Drive E  
Montgomery, TX 77356 Participation Type: Active Supplier

Invitation Date 05/14/2021  
Invitation Type Automatic  
Invitation Email(s) gllookabaugh@yahoo.com

Landmark Electric Company (Landmark Electric Co.)

Address 4033 Bradford  
Corpus Christi, TX 78411 Participation Type: Active Supplier

Invitation Date 05/14/2021  
Invitation Type Automatic  
Invitation Email(s)

Lange Mechanical Services, L.P.

Address 933 Wakefield Drive  
Houston, TX 77018 Participation Type: Active Supplier

Invitation Date 05/14/2021  
Invitation Type Automatic  
Invitation Email(s) BRamos@langemechanical.com

Laser Imaging (Hallmarks Laser Imaging)

Address 11101 Cutten Rd. STE 107  
Houston, TX 77066 Participation Type: Active Supplier

Classifications HUB (Primary),WBE

Invitation Date 05/14/2021  
Invitation Type Automatic  
Invitation Email(s) shallmark@laserimaginginc.com

Leather Only Products

---

Address 9220 Summerbell Lane Participation Type: Active Supplier  
Houston, TX 77074

Classifications SBE (Primary)

Invitation Date 05/14/2021  
Invitation Type Automatic  
Invitation Email(s) cn@leatheronlyproducts.com

LEDs Unlimited LLC

---

Address 3300 Parliament Participation Type: Active Supplier  
Lago Vista, TX 78645

Classifications TIP,SBE,WBE (Primary)

Invitation Date 05/14/2021  
Invitation Type Automatic  
Invitation Email(s) tracy@leds-unlimited.com

Levy's Tutorial and Enrichment Center (Mary Baumann)

---

Address 4814 Burma Rd Participation Type: Active Supplier  
Houston, TX 77033

Classifications MBE (Primary),SBE,WBE

Response Date 05/28/2021  
Response Status No Bid  
Status Date 05/28/2021

Lexine Group (Lexine Inc)

---

Address 322 N 3rd St Participation Type: Active Supplier  
McAllen, TX 78501

Classifications HUB (Primary)

Invitation Date 05/14/2021  
Invitation Type Automatic  
Invitation Email(s) anna@lexinegroup.com

Lowes Companies Inc

---

Address 1000 Lowes Blvd Participation Type: Active Supplier  
 Mooresville, NC 28117

Invitation Date 05/14/2021  
Invitation Type Automatic  
Invitation Email(s)

LVI Energy

---

Address 701 E Plano Pkwy. Participation Type: Active Supplier  
Plano, TX 75074

Invitation Date 05/14/2021  
Invitation Type Automatic  
Invitation Email(s)

M&H Lighting Systems (Mapenzi Group)

---

Address 706 Maple Branch Ln Participation Type: Active Supplier  
Pearland, TX 77584

Classifications MBE (Primary)

Invitation Date 05/14/2021  
Invitation Type Automatic  
Invitation Email(s) wmartin@mhlightsystems.com

M.E.N. (Mentoring, Educating & Nurturing) Incorporated (MEN Inc.)

---

Address 3033 CHIMNEY ROCK ROAD Participation Type: Active Supplier  
Houston, TX 77056

Response Date 05/15/2021  
Response Status No Bid  
Status Date 05/15/2021

MAINLAND SUPPLY

---

Address 1070 Vega Way Participation Type: Active Supplier  
San Marcos, CA 92078

Classifications WBE (Primary)

Invitation Date 05/14/2021  
Invitation Type Automatic  
Invitation Email(s) gguizon@mainlandsupply.com

Malor & Company Inc

---

Address 554 West 54th Participation Type: Active Supplier  
New York, NY 10019

Classifications MBE (Primary),SBE

Invitation Date 05/14/2021  
Invitation Type Automatic  
Invitation Email(s) garly.b@malorcompany.com

MANS DISTRIBUTORS, INC.

---

Address 3120 Kellway Dr Participation Type: Active Supplier  
Carrollton, TX 75006

Classifications MBE,SBE (Primary),HUB,WBE

Invitation Date 05/14/2021  
Invitation Type Automatic  
Invitation Email(s) SADHNA@MANS.US

Mansfield Power and Gas, LLC

---

Address 1025 Airport Parkway SW Participation Type: Active Supplier  
Gainesville, GA 30501

Invitation Date 05/14/2021  
Invitation Type Automatic  
Invitation Email(s) mpgbids@mansfieldpowergas.com

Mata Boxing Promotions- MBP (Jason Mata)

---

Address 2925 W COMMERCE ST Participation Type: Active Supplier  
SAN ANTONIO, TX 78207-3719

Classifications MBE,SBE,HUB (Primary)

Invitation Date 05/14/2021  
Invitation Type Automatic  
Invitation Email(s) jmata146@gmail.com

Mats Unlimited

---

Address 311 Elm Drive Participation Type: Active Supplier  
Terrell, TX 75160

Classifications MBE (Primary),SBE,WBE

Invitation Date 05/14/2021  
Invitation Type Automatic  
Invitation Email(s) teabell@sbcglobal.net

MAVICH

---

Address 525 Commerce Street Participation Type: Active Supplier  
Southlake, TX 76092

Invitation Date 05/14/2021  
Invitation Type Automatic  
Invitation Email(s) sales@mavich.com

Mayfield Paper Co

---

Address 1115 S. Hill Street Participation Type: Active Supplier  
San Angelo, TX 76903

Classifications TAS (Primary)

Invitation Date 05/14/2021  
Invitation Type Automatic  
Invitation Email(s) dcreecy@mayfieldpaper.com

McKinstry (McKinstry Essention, Inc.)

---

Address 4201 Spring Valley Rd. Participation Type: Active Supplier  
Dallas, TX 75244

Classifications TIP (Primary)

Invitation Date 05/14/2021  
Invitation Type Automatic  
Invitation Email(s) brookm@mckinstry.com

McMac Commissioning Services, LLC.

---

Address 712 E 20th St. Participation Type: Active Supplier  
Houston, TX 77008

Invitation Date 05/14/2021  
Invitation Type Automatic  
Invitation Email(s) david.maclean@mcmaccx.net

MCS Enterprises

---

Address 4112 Fannin Participation Type: Active Supplier  
Houston, TX 77004

Classifications MBE,SBE (Primary)

Invitation Date 05/14/2021  
Invitation Type Automatic  
Invitation Email(s)

Meredith Digital

---

Address 20725 S Western ste 150 Participation Type: Active Supplier  
torrance, CA 90501

Classifications SBE (Primary)

Invitation Date 05/14/2021  
Invitation Type Automatic  
Invitation Email(s)

METCO Engineering, Inc.

---

Address 3333 Lee PKWY Participation Type: Active Supplier  
Dallas, TX 75219

Invitation Date 05/14/2021  
Invitation Type Automatic  
Invitation Email(s) tara@metcoengineering.com



Midstate Energy, LLC, A Veregy Company

Address 23325 N 23rd Ave Participation Type: Active Supplier  
Phoenix, AZ 85027

Invitation Date 05/14/2021  
Invitation Type Automatic  
Invitation Email(s) vesparza@veregy.com

Miracle Method of Austin (Nartor Associates Inc)

Address 8906 Wall St, Suite 501 Participation Type: Active Supplier  
Austin, TX 78754

Invitation Date 05/14/2021  
Invitation Type Automatic  
Invitation Email(s) adominick@miraclemethod.com

Morris Boiler Service (JEMDSI, Inc.)

Address 1201 W 2nd Street Participation Type: Active Supplier  
Mercedes, TX 78570

Invitation Date 05/14/2021  
Invitation Type Automatic  
Invitation Email(s) ericmancias@yahoo.com

MP2 Energy (MP2 Energy Texas LLC)

Address 21 Waterway Ave., Ste. 450 Participation Type: Active Supplier  
The Woodlands, TX 77380

Invitation Date 05/14/2021  
Invitation Type Automatic  
Invitation Email(s) jodie.adams@mp2energy.com  
Response Status Viewed  
Status Date 06/08/2021

MRU-Instruments Inc.

Address 13514 Breakwater Path Loop Participation Type: Active Supplier  
Houston, TX 77044

Classifications SBE (Primary)

Invitation Date 05/14/2021  
Invitation Type Automatic  
Invitation Email(s)

MSC Industrial Supply (Sid Tool Co.)

Address P O Box 953635 Participation Type: Active Supplier  
St. Louis, MO 63195-3635

Invitation Date 05/14/2021  
Invitation Type Automatic  
Invitation Email(s) ralph.walton@mscdirect.com stumpm@mscdirect.com

Mtech (Mechanical Technical Services, Inc.)

Address 17305 IH 35 North, Ste. 105 Participation Type: Active Supplier  
Schertz, TX 78154

Invitation Date 05/14/2021  
Invitation Type Automatic  
Invitation Email(s) stephanie.rainbow@csusa.us

Nathan Branch

Address 2321 Commerce St Participation Type: Active Supplier  
Alpharetta, GA 30009

Invitation Date 05/14/2021  
Invitation Type Automatic  
Invitation Email(s) nathan@uvmedical.us

National Glazing Solutions, LLC

Address 981 Joseph E Lowery Blvd NW Suite 106 Participation Type: Active Supplier  
Atlanta, GA 30318

Invitation Date 05/14/2021  
Invitation Type Automatic  
Invitation Email(s) Donnie@filmsandgraphics.com

NEC co-op energy

Address 14353 Cooperative Ave Participation Type: Active Supplier  
Robstown, TX 78380

Invitation Date 05/14/2021  
Invitation Type Automatic  
Invitation Email(s) agarza@neccoopenergy.com

NetworkThermostat (J Drew Inc.)

Address 932 Jean Street Participation Type: Active Supplier  
Grapevine, TX 76051

Invitation Date 05/14/2021  
Invitation Type Automatic  
Invitation Email(s) sdrew@networkthermostat.com

Neutex Advanced Energy Group, Inc

Address 14340 Torrey Chase Blvd, Suite 250 Participation Type: Active Supplier  
Houston, TX 77014

Invitation Date 05/14/2021  
Invitation Type Automatic  
Invitation Email(s) msamjr@neutexworld.com

NORESKO

Address 10607 Haddington Drive Participation Type: Active Supplier  
Houston, TX 77043

Classifications DIR (Primary),USC

Invitation Date 05/14/2021  
Invitation Type Automatic  
Invitation Email(s) ksissingh@noresko.com cgibson@noresko.com egranhaug@noresko.com  
Response Status Viewed  
Status Date 05/17/2021

NuEnergen, LLC

Address 10 Bank Street Participation Type: Active Supplier  
White Plains, NY 10606

Invitation Date 05/14/2021  
Invitation Type Automatic  
Invitation Email(s) mlee@nuenergen.com  
Response Status Viewed  
Status Date 05/19/2021

O3 Energy Solutions (O3 Energy LLC)

Address 325 NORTH ST PAUL ST STE 3100 Participation Type: Active Supplier  
DALLAS, TX 75201

Invitation Date 05/14/2021  
Invitation Type Automatic  
Invitation Email(s)

OBELLO, INC

Address 12500 Merit Drive Participation Type: Active Supplier  
Dallas, TX 75251

Classifications MBE (Primary),WBE

Invitation Date 05/14/2021  
Invitation Type Automatic  
Invitation Email(s) dobcalldemo@gmail.com

OfficePro Supply Company LLC

Address 15340 Vantage Pkwy E Suite 250 Participation Type: Active Supplier  
HOUSTON, TX 77032

Invitation Date 05/14/2021  
Invitation Type Automatic  
Invitation Email(s) Rachael@opsupply.com

OGH Services, Inc

Address 3730 Creekmont Drive Participation Type: Active Supplier  
Houston, TX 77091

Classifications HUB (Primary)

Invitation Date 05/14/2021  
Invitation Type Automatic  
Invitation Email(s) ggibson@oghservices.com vinceb@oghservices.com wendy@oghservices.com

Ogni Inc

Address 140 E Commercial St, Suite 1 Participation Type: Active Supplier  
Wood Dale, IL 60191

Classifications MBE (Primary)

Invitation Date 05/14/2021  
Invitation Type Automatic  
Invitation Email(s) bidresponse@ognigroup.net

Omega Roofing & Construction

Address 16215 Westheimer Rd Participation Type: Active Supplier  
Houston, TX 77082

Classifications MBE (Primary),SBE,HUB

Invitation Date 05/14/2021  
Invitation Type Automatic  
Invitation Email(s) jessica@omegarc.com

Opal R. Helm, LLC

Address 718 Peddie St Participation Type: Active Supplier  
Houston, TX 77008

Classifications MBE (Primary),SBE,WBE

Invitation Date 05/14/2021  
Invitation Type Automatic  
Invitation Email(s) jennifer@halseyandhelm.com

PANTHEON Advanced Illumination LLC

Address 10526 N-135 Participation Type: Active Supplier  
San Antonio, TX 78233

Classifications MBE,SBE,HUB (Primary)

Invitation Date 05/14/2021  
Invitation Type Automatic  
Invitation Email(s) matthew@pantheonled.com

PARADISE AIR (Luck & Logic Inc.)

Address 351 Columbia Memorial Pkwy Participation Type: Active Supplier  
Kemah, TX 77565

Classifications SBE (Primary),WBE

Invitation Date 05/14/2021  
Invitation Type Automatic  
Invitation Email(s) paradiseairkemah@gmail.com

PC Specialists Inc. (Technology Integration Group)

Address 121 Interpark Blvd. Participation Type: Active Supplier  
San Antonio, TX 78232

Classifications MBE (Primary)

Invitation Date 05/14/2021  
Invitation Type Automatic  
Invitation Email(s) mario.gonzalez@tig.com jerrie.dodd@tig.com

PCJ Consultants Inc.

Address 13110 Green Shores Lane Participation Type: Active Supplier  
Rosharon, TX 77583

Invitation Date 05/14/2021  
Invitation Type Automatic  
Invitation Email(s) pcj@pcj-usa.com

Pepco Energy Services

Address 1200 W. Walnut Hill Lane Participation Type: Active Supplier  
Irving, TX 75035

Invitation Date 05/14/2021  
Invitation Type Automatic  
Invitation Email(s)

Perry Mechanical Service

Address 3623 W Alberta Rd Participation Type: Active Supplier  
Edinburg, TX 78539

Invitation Date 05/14/2021  
Invitation Type Automatic  
Invitation Email(s) brennan@perry-mechanical.com

PKJ International LLC

Address 12999 Murphy Road, Ste. N6 Participation Type: Active Supplier  
Stafford, TX 77477

Classifications MBE,SBE (Primary)

Response Status Viewed  
Status Date 05/25/2021

PREMIER & COMPANIES

Address 237 WEST 35TH STREET Participation Type: Active Supplier  
NEW YORK, NY 10001

Classifications SBE (Primary)

Invitation Date 05/14/2021  
Invitation Type Automatic  
Invitation Email(s)

Premier Wireless

Address 12220 Murphy Rd.,  
Stafford, TX 77477 Participation Type: Active Supplier

Invitation Date 05/14/2021  
Invitation Type Automatic  
Invitation Email(s) bids@premierwirelesstx.com

Preschool Express Learning Academy

Address 1502 First St  
Humble, TX 77338 Participation Type: Active Supplier

Classifications MBE (Primary),WBE

Invitation Date 05/14/2021  
Invitation Type Automatic  
Invitation Email(s) miss.brittany2006@yahoo.com

Prime Central Store (Waretrack, Inc.)

Address 6229 Theall Road  
HOUSTON, TX 77066 Participation Type: Active Supplier

Invitation Date 05/14/2021  
Invitation Type Automatic  
Invitation Email(s) gms@medisouth.com

Principle Information Technology

Address 9301 Southwest fwy, Suite 475  
Houston, TX 77074 Participation Type: Active Supplier

Classifications MBE,DIR,SBE (Primary),HUB

Invitation Date 05/14/2021  
Invitation Type Automatic  
Invitation Email(s) reddy@principleinfotech.com

Pro Tech Mechanical, Inc

Address 6436 Harwick Dr.  
Corpus Christi, TX 78417 Participation Type: Active Supplier

Classifications SBE (Primary)

Invitation Date 05/14/2021  
Invitation Type Automatic  
Invitation Email(s) Dan@protechmech.com

Professional Plastics Inc.

Address 2060 LUNA RD SUITE 120  
CARROLLTON, TX 75006 Participation Type: Active Supplier

Invitation Date 05/14/2021  
Invitation Type Automatic  
Invitation Email(s) M.Freed@proplas.com

Prosperity Project Management LLC (N/A)

Address 1230 Euclid Street NW  
Washington, DC 20009 Participation Type: Active Supplier

Classifications MBE (Primary),WBE

Invitation Date 05/14/2021  
Invitation Type Automatic  
Invitation Email(s) Jousett@prosperityprojectmanagementllc.com  
Response Status Viewed  
Status Date 05/25/2021

ProSport Logistics

Address 3806 Kelley Ave. Suite A  
Springdale, AR 72762 Participation Type: Active Supplier

Invitation Date 05/14/2021  
Invitation Type Automatic  
Invitation Email(s)

Providence Office Products LLC

Address 16753  
Conroe, TX 77385 Participation Type: Active Supplier

Invitation Date 05/14/2021  
Invitation Type Automatic  
Invitation Email(s) admin@providenceofficeproducts.com

Rave Energy

Address 7700 Windrose Ave.  
Plano, TX 75024 Participation Type: Active Supplier

Classifications MBE (Primary)

Response Date 06/10/2021  
Response Status Submitted  
Status Date 06/10/2021

RCK Equipment Solutions (Curtis Collins and Katina Collins)

Address 6000 N Sam Houston Pkwy E #610  
Humble, TX 77396 Participation Type: Active Supplier

Invitation Date 05/14/2021  
Invitation Type Automatic  
Invitation Email(s) Katina@rckequip.com

RDI Mechanical

Address 7150 Breen Dr.  
Houston, TX 77086 Participation Type: Active Supplier

Invitation Date 05/14/2021  
Invitation Type Automatic  
Invitation Email(s) chris@rdimechanical.com

Ready Trans Limited Liability Company

Address 14560 Pensham Dr  
Frisco, TX 75035 Participation Type: Active Supplier

Invitation Date 05/14/2021  
Invitation Type Automatic  
Invitation Email(s) udaymachchhar@gmail.com

Reflective Energy Solutions

Address One University Plaza Suite 407  
Hackensack, NJ 07601 Participation Type: Active Supplier

Invitation Date 05/14/2021  
Invitation Type Automatic  
Invitation Email(s) kevind@reflectivees.com

Refrigeration Technologies, LLC

Address 1055 South Hanover St.  
Pottstown, PA 19465 Participation Type: Active Supplier

Classifications SBE (Primary)

Invitation Date 05/14/2021  
Invitation Type Automatic  
Invitation Email(s) sj.wezel@gmail.com myannessa@refrigerationtechnologiesllc.com

Region One ESC

---

Address 1900 W. Schunior  
Edinburg, TX 78541 Participation Type: Active Supplier

Invitation Date 05/14/2021  
Invitation Type Automatic  
Invitation Email(s) laramos@esc1.net

Reliant Energy (Reliant Energy Retail Services, LLC)

---

Address 1201 Fannin  
Houston, TX 77002 Participation Type: Active Supplier

Invitation Date 05/14/2021  
Invitation Type Automatic  
Invitation Email(s) frances.perkins@nrg.com pbrian@reliant.com RFPTeam@nrg.com bradford.pete-hill@nrg.com  
Response Date 06/10/2021  
Response Status Submitted  
Status Date 06/10/2021

Renaissance Power Conservation

---

Address PO Box 11723  
Norfolk, VA 23517 Participation Type: Active Supplier

Classifications SBE (Primary)

Invitation Date 05/14/2021  
Invitation Type Automatic  
Invitation Email(s)

Resource Energy Systems, LLC

---

Address 4 High Ridge Park  
Stamford, CT 06905 Participation Type: Active Supplier

Invitation Date 05/14/2021  
Invitation Type Automatic  
Invitation Email(s) mhyland@resglobal.com

Retro Lighting & Conservation

---

Address 3407 Autumn Bend Dr  
Sugar Land, TX 77479 Participation Type: Active Supplier

Classifications SBE (Primary)

Invitation Date 05/14/2021  
Invitation Type Automatic  
Invitation Email(s) retrolighting@comcast.net

Ringdale, Inc.

---

Address 101 Halmar Covd  
Georgetown, TX 78628 Participation Type: Active Supplier

Invitation Date 05/14/2021  
Invitation Type Automatic  
Invitation Email(s) cmcclanahan@ringdale.com

Rio Paper & Supply LLC

---

Address 1800 Mozelle Avenue  
Pharr, TX 78577 Participation Type: Active Supplier

Invitation Date 05/14/2021  
Invitation Type Automatic  
Invitation Email(s) Rickcriopaper@yahoo.com

RKD Enterprise

Address 17202 Quiet Grove Ln  
Humble, TX 77346 Participation Type: Active Supplier

Classifications SBE (Primary)

Invitation Date 05/14/2021  
Invitation Type Automatic  
Invitation Email(s) dmdavis75@aol.com

Sabari Tech Solutions LLC

Address 16914 Clola Ct  
Richmond, TX 77407 Participation Type: Active Supplier

Classifications MBE (Primary),WBE

Response Status Viewed  
Status Date 06/09/2021

Scogin Aire Mechanical (Scogin Aire Mechanical)

Address 3091 College Park Suite 240 #2  
The Woodlands, TX 77384 Participation Type: Active Supplier

Invitation Date 05/14/2021  
Invitation Type Automatic  
Invitation Email(s) Customerservice@scoginaire.com

Seahurst Energy Services (Seahurst Electric)

Address PO Box 131974  
The Woodlands, TX 77393 Participation Type: Active Supplier

Classifications SBE (Primary)

Invitation Date 05/14/2021  
Invitation Type Automatic  
Invitation Email(s) ereeves@seahurst.com

Sempra Energy Solutions

Address 2500 City West Blvd., Suite 1800  
Houston, TX 77042 Participation Type: Active Supplier

Invitation Date 05/14/2021  
Invitation Type Automatic  
Invitation Email(s) frodriguez@semprasolutions.com

SETEX Facilities & Maintenance, LLC

Address PO Box 20678  
Beaumont, TX 77720 Participation Type: Active Supplier

Classifications SBE

Invitation Date 05/14/2021  
Invitation Type Automatic  
Invitation Email(s) Shannane@setexconstruction.com Lynidac@setexconstruction.com

Siemens Industry, Inc

Address 8850 Fallbrook Rd  
Houston, TX 77063 Participation Type: Active Supplier

Classifications TXM (Primary)

Invitation Date 05/14/2021  
Invitation Type Automatic  
Invitation Email(s) keith.chase@seimens.com



Smith & Company Architects

Address 12603 Southwest Freeway  
Stafford, TX 77477 Participation Type: Active Supplier

Classifications MBE,SBE,HUB (Primary)

Invitation Date 05/14/2021  
Invitation Type Automatic  
Invitation Email(s) icanez@sc-arch.com

Solar Conduit, LLC

Address 1840 Grandstand Drive  
San Antonio, TX 78238 Participation Type: Active Supplier

Classifications MBE,SBE (Primary)

Invitation Date 05/14/2021  
Invitation Type Automatic  
Invitation Email(s) laura.carr@solarconduit.com

SourceOne, Inc.

Address 135 Overbrook Drive  
Killington, VT 05751 Participation Type: Active Supplier

Invitation Date 05/14/2021  
Invitation Type Automatic  
Invitation Email(s) amalatzky@s1inc.com

SOUTH TEXAS PUMP INC

Address PO BOX 1852  
WESLACO, TX 78599 Participation Type: Active Supplier

Invitation Date 05/14/2021  
Invitation Type Automatic  
Invitation Email(s) stpump@gmail.com

Spark Power Corp

Address 6131 Woodlake Center  
San Antonio, TX 78244 Participation Type: Active Supplier

Invitation Date 05/14/2021  
Invitation Type Automatic  
Invitation Email(s) smercer@sparkpowercorp.com nsanchez@sparkpowercorp.com jgarza@sparkpowercorp.com  
Response Status Viewed  
Status Date 06/08/2021

Sparkling Clear Industries

Address 422 WEST PLANTATION  
CLUTE, TX 77531 Participation Type: Active Supplier

Classifications SBE (Primary)

Invitation Date 05/14/2021  
Invitation Type Automatic  
Invitation Email(s) sjohnson@sparklingclear.com  
Response Status Viewed  
Status Date 06/08/2021

SPZ GLOBAL ENERGY LLC

Address 8-3 bergen ridge rd  
north bergen, NJ 07047 Participation Type: Active Supplier

Classifications WBE (Primary)

Invitation Date 05/14/2021  
Invitation Type Automatic  
Invitation Email(s) keara@spzcap.com

Stanley Convergent Security

Address 6699 Portwest Drive, 100 Houston, TX 77024 Participation Type: Active Supplier

Invitation Date 05/14/2021  
Invitation Type Automatic  
Invitation Email(s) christine.perry@sbdinc.com

Stauffer Glove and Safety

Address 361 E 6th Street Red Hill, PA 18076 Participation Type: Active Supplier

Invitation Date 05/14/2021  
Invitation Type Automatic  
Invitation Email(s) dalton@stauffersafety.com

StoneX Financial Inc.

Address 1425 Oread West #105 Lawrence, KS 66049 Participation Type: Active Supplier

Response Status Viewed  
Status Date 05/17/2021

Strategic Partnerships, Inc.

Address 901 S. Mopac Expy Austin, TX 78746 Participation Type: Active Supplier

Classifications WBE (Primary)

Invitation Date 05/14/2021  
Invitation Type Automatic  
Invitation Email(s) kyoshida@spartnerships.com

Successful Starters Learning Academy II

Address P.O. Box 111144 Hosuton, TX 77293 Participation Type: Active Supplier

Classifications MBE (Primary),SBE,WBE

Invitation Date 05/14/2021  
Invitation Type Automatic  
Invitation Email(s) carlasmithford@sbcglobal.net

Summit Electric Supply Co. Inc.

Address 8718 West Little York #100 Houston, TX 77040 Participation Type: Active Supplier

Invitation Date 05/14/2021  
Invitation Type Automatic  
Invitation Email(s)

Supply Works (Interline Brands)

Address 701 San Marco Blvd Jacksonville, FL 32207 Participation Type: Active Supplier

Classifications TAS (Primary)

Invitation Date 05/14/2021  
Invitation Type Automatic  
Invitation Email(s) jim.kij@supplyworks.com jknight@supplyworks.com Mike.canales@sexauer.com institutional-governmentbidsteam@interlinebrands.com

Sylvania Lighting Solutions (Sylvania Lighting Services Corp)

---

Address 200 Ballardvale Road Participation Type: Active Supplier  
Wilmington, MA 01887

Invitation Date 05/14/2021  
Invitation Type Automatic  
Invitation Email(s) larry.daniels@osram.com

TD Industries

---

Address 13850 Diplomat Drive Participation Type: Active Supplier  
Dallas, TX 75234

Invitation Date 05/14/2021  
Invitation Type Automatic  
Invitation Email(s) Lorraine.Vuong@TDIndustries.com

Techno Mechanical Solutions, LLC

---

Address 7000 N MO PAC EXPY STE 200 Participation Type: Active Supplier  
Austin, TX 78731

Classifications MBE (Primary),SBE,WBE

Invitation Date 05/14/2021  
Invitation Type Automatic  
Invitation Email(s) yortiz@techno-ms.com

Texas Art Supply Company

---

Address 2001 Montrose Blvd. Participation Type: Active Supplier  
Houston, TX 77006

Classifications TCP (Primary),SBE

Response Date 06/08/2021  
Response Status No Bid  
Status Date 06/08/2021

Texas Association of African American Chambers of Commerce (TAAACC)

---

Address 807 Brazos Street Participation Type: Active Supplier  
Austin, TX 78701

Classifications MBE,SBE (Primary),WBE

Invitation Date 05/14/2021  
Invitation Type Automatic  
Invitation Email(s) info@taaacc.org

Texas Motor and Control

---

Address 1500 Alegacy Place Participation Type: Active Supplier  
Waller, TX 77484

Invitation Date 05/14/2021  
Invitation Type Automatic  
Invitation Email(s) christiem@txmac.com

Texas Solar Resources, Inc.

---

Address 109A Laurel Drive Participation Type: Active Supplier  
Friendswood, TX 77546

Classifications SBE,WBE (Primary)

Invitation Date 05/14/2021  
Invitation Type Automatic  
Invitation Email(s)

TFC MECHANICAL (TFC Mechanical LLC)

Address 1010 squire wylie, TX 75098 Participation Type: Active Supplier

Invitation Date 05/14/2021  
Invitation Type Automatic  
Invitation Email(s) jack@tfcmechanical.com

The Brandt Companies, LLC

Address 13810 Hollister Rd Houston, TX 77086 Participation Type: Active Supplier

Classifications TXM (Primary)

Invitation Date 05/14/2021  
Invitation Type Automatic  
Invitation Email(s) micah.hunter@Brandt.us Toni.whitaker@brandt.us Trey.calvery@brandt.us Christopher.clegg@brandt.us

The Comfort King (Gideon Lynn LLC)

Address 590 Brandon rd. Conroe, TX 78309 Participation Type: Active Supplier

Invitation Date 05/14/2021  
Invitation Type Automatic  
Invitation Email(s) Garrettcomfortking@gmail.com

The Filter Guy

Address 536 Long Creek Road Bldg 3 Sunnyvale, TX 75182 Participation Type: Active Supplier

Invitation Date 05/14/2021  
Invitation Type Automatic  
Invitation Email(s) thefilterguy@tx.rr.com

The Filter Man LLC

Address 18924 E. Industrial Parkway New Caney, TX 77357 Participation Type: Active Supplier

Invitation Date 05/14/2021  
Invitation Type Automatic  
Invitation Email(s) cathy@filtermanltd.com

The Green Alliance

Address 1795 N. Fry Rd. Katy, TX 77449 Participation Type: Active Supplier

Invitation Date 05/14/2021  
Invitation Type Automatic  
Invitation Email(s) amy@thegreenalliance.co

The Home Depot

Address 999 North Loop West Houston, TX 77008 Participation Type: Active Supplier

Classifications TXM (Primary),USC

Invitation Date 05/14/2021  
Invitation Type Automatic  
Invitation Email(s) Luke\_s\_vancantfort@homedepot.com

The MarketinGroup, LLC

Address 2261 North Park Dr. Kingwood, TX 77339 Participation Type: Active Supplier

Invitation Date 05/14/2021  
Invitation Type Automatic  
Invitation Email(s) tmg@themarketinggroup.us

The National Behavioral Intervention Team Association

Address 475 Allendale Rd Suite 200 Participation Type: Active Supplier  
King of Prussia, PA 19102

Invitation Date 05/14/2021  
Invitation Type Automatic  
Invitation Email(s) Christopher.Simmons@TNGConsulting.com

The Reynolds Company

Address 10502 Greens Crossing Blvd. Participation Type: Active Supplier  
Houston, TX 77038

Classifications TAS (Primary)

Invitation Date 05/14/2021  
Invitation Type Automatic  
Invitation Email(s) wlglas@reynco.com

The TEAMS Group, LLC

Address 143 Emma Loop Participation Type: Active Supplier  
Austin, TX 78737

Invitation Date 05/14/2021  
Invitation Type Automatic  
Invitation Email(s) lg@theteamsgroup.com

THG Energy Solutions

Address 7155 Old Katy Road Participation Type: Active Supplier  
Houston, TX 77024

Classifications SBE (Primary)

Invitation Date 05/14/2021  
Invitation Type Automatic  
Invitation Email(s) cburden@thgenergy.com mfrey@thgenergy.com  
Response Status Viewed  
Status Date 05/14/2021

Tico Telehealth Inc.

Address 10712 Culberson Participation Type: Active Supplier  
Austin, TX 78748

Classifications SBE (Primary),WBE

Invitation Date 05/14/2021  
Invitation Type Automatic  
Invitation Email(s) l.bibby@ticotelehealth.com

Timilon Corporation

Address 24301 Walden Center Dr Participation Type: Active Supplier  
Bonita Springs, FL 34134

Invitation Date 05/14/2021  
Invitation Type Automatic  
Invitation Email(s) lkitman@timilon.com

Tradition Energy

Address 3050 Post Oak Blvd, Suite 530 Participation Type: Active Supplier  
Houston, TX 77056

Invitation Date 05/14/2021  
Invitation Type Automatic  
Invitation Email(s) kristin.demarco@traditionenergy.com

Trane Energy Supply Services (Trane U.S. Inc.)

Address 1617 Hutton Dr  
Carrollton, TX 75006 Participation Type: Active Supplier

Invitation Date 05/14/2021  
Invitation Type Automatic  
Invitation Email(s) trevor.joelson@trane.com

Transcare llc

Address 9203 hwy 6 S  
Houston, TX 77083 Participation Type: Active Supplier

Invitation Date 05/14/2021  
Invitation Type Automatic  
Invitation Email(s) transcarehou@gmail.com

Turner Power and Construction, LLC (Turner Power Systems and Conctractors, LLC)

Address 12707 Haynes Rd  
Houston, TX 77066 Participation Type: Active Supplier

Invitation Date 05/14/2021  
Invitation Type Automatic  
Invitation Email(s) ron@turnerpower.com kimberly@turnerpower.com

TXU Energy

Address 2603 Augusta Dr  
Houston, TX 77057 Participation Type: Active Supplier

Invitation Date 05/14/2021  
Invitation Type Automatic  
Invitation Email(s) Emily.Sohlden@txu.com  
Response Date 06/10/2021  
Response Status Submitted  
Status Date 06/10/2021

U. S. WHOLESALE PRODUCTS

Address PO BOX 34483  
SAN ANTONIO, TX 78265 Participation Type: Active Supplier

Classifications SBE (Primary)

Invitation Date 05/14/2021  
Invitation Type Automatic  
Invitation Email(s) uswpsanantonio@gmail.com

U.S Electronics recycling Center Inc (Isaac F Sunday)

Address 6210 S Dairly Ashford Suite A4  
Houston, TX 77072 Participation Type: Active Supplier

Classifications MBE (Primary),SBE

Invitation Date 05/14/2021  
Invitation Type Automatic  
Invitation Email(s) sunif1985@yahoo.com

ULE Group

Address 60 Hoffman Ave  
Hauppauge, NY 11788 Participation Type: Active Supplier

Invitation Date 05/14/2021  
Invitation Type Automatic  
Invitation Email(s) mbocian@ulegrp.com

Unified Sunergy Systems LLC

Address 2204 Sagebrush Drive Participation Type: Active Supplier  
Flower Mound, TX 75028

Classifications MBE (Primary),SBE

Invitation Date 05/14/2021  
Invitation Type Automatic  
Invitation Email(s) Ali.Mehmud@unifiedsunergy.com

UniFirst Corporation

Address 455 Airport Rd. Participation Type: Active Supplier  
Corpus Christi, TX 78405

Invitation Date 05/14/2021  
Invitation Type Automatic  
Invitation Email(s) ryan\_jay@unifirst.com

Unify Energy Solutions

Address 770 Bradfield, Suite 585 Participation Type: Active Supplier  
Houston, TX 77060

Classifications TIP (Primary)

Invitation Date 05/14/2021  
Invitation Type Automatic  
Invitation Email(s) jeffn@unifyes.com todds@unifytexas.com

Uninex International (Unicorp)

Address 5780 Smithway Street Participation Type: Active Supplier  
Commerce, CA 90040

Invitation Date 05/14/2021  
Invitation Type Automatic  
Invitation Email(s) cinthyac@uninex.com

Ursin's Energy Efficient Lighting,LLC.

Address 505 N. Sam Houston pkwy east ste#304 Participation Type: Active Supplier  
Houston, TX 77060

Classifications MBE,TPA,TXM,SBE (Primary),HUB

Invitation Date 05/14/2021  
Invitation Type Automatic  
Invitation Email(s) edursin@ursinsighting.net

Utilities Dynamics Inc.

Address 9316 N. 147th E. Ave Participation Type: Active Supplier  
Owasso, OK 74055

Invitation Date 05/14/2021  
Invitation Type Automatic  
Invitation Email(s)

Van Brunt & Associates, Inc.

Address 3609 Albans Participation Type: Active Supplier  
Houston, TX 77005

Classifications MBE,HUB,WBE (Primary)

Invitation Date 05/14/2021  
Invitation Type Automatic  
Invitation Email(s) avanbrunt@vbenergy.com  
Response Status Viewed  
Status Date 05/14/2021

Way Service, Ltd.

Address 5308 Ashbrook Dr. Participation Type: Active Supplier  
Houston, TX 77081

Classifications TIP (Primary)

Invitation Date 05/14/2021  
Invitation Type Automatic  
Invitation Email(s) btripathi@wayservice.com rdombrowski@wayservice.com

Whitener Enterprises, Inc

Address 1296 FM 3083 Participation Type: Active Supplier  
Conroe, TX 77301

Invitation Date 05/14/2021  
Invitation Type Automatic  
Invitation Email(s) beth@whient.com bryan@whient.com wwatts4@aol.com

Willbanks & Associates, Inc.

Address 6610 Stillwell St Participation Type: Active Supplier  
Houston, TX 77087

Invitation Date 05/14/2021  
Invitation Type Automatic  
Invitation Email(s) treyw@willbanksinc.com

Worldwide Power Products

Address 5711 Brittmoore Road Participation Type: Active Supplier  
Houston, TX 77041

Invitation Date 05/14/2021  
Invitation Type Automatic  
Invitation Email(s) sspidle@wpowerproducts.com

Xyple LLC

Address 2601 La Frontera Blvd Participation Type: Active Supplier  
Round Rock, TX 78681

Invitation Date 05/14/2021  
Invitation Type Automatic  
Invitation Email(s) tokonkwor@xyple.com

Your Pro Medical Inc. (Your Pro Consultant Inc.)

Address P.O. Box 111487 Participation Type: Active Supplier  
Carrollton, TX 75011

Classifications MBE (Primary),SBE,WBE

Invitation Date 05/14/2021  
Invitation Type Automatic  
Invitation Email(s) admin@yourpromedical.org

Zenith Designs, LLC

Address 12823 Kingsbridge Lane Participation Type: Active Supplier  
Houston, TX 77077

Classifications MBE (Primary),SBE

Invitation Date 05/14/2021  
Invitation Type Automatic  
Invitation Email(s) chris@zenithdesigns.co



Zerimar Lighting Solutions (Ram Ramirez Enterprises Inc.)

Address 2010 W. Houston Ave Participation Type: Active Supplier  
McAllen, TX 78501

Classifications MBE,SBE (Primary),HUB

Invitation Date 05/14/2021  
Invitation Type Automatic  
Invitation Email(s) zerimarlightingleo@sbcglobal.net

---

**Bid Activity Detail**

1st Advertisement

Activity Date 5/14/2021 12:00:00 AM (CT)  
Description

2nd Advertisement

Activity Date 5/17/2021 12:00:00 AM (CT)  
Description

Virtual Pre-Proposal Meeting - Not Mandatory

Activity Date 5/19/2021 10:00:00 AM (CT)  
Description The Pre-Proposal Meeting will be held virtually via Zoom conferencing.

Topic: RFP# 21/058MJ Energy Purchase Virtual Pre-Proposal Meeting  
Time: May 19, 2021 10:00 AM Central Time (US and Canada)

Join Zoom Meeting  
<https://zoom.us/j/97611331208?pwd=TFpqbUZGcnhmWExTRERkWWIJUVJsUT09>

Meeting ID: 976 1133 1208  
Passcode: PSMZ0L

Virtual Public Bid Opening - Not Mandatory

Activity Date 6/10/2021 02:00:00 PM (CT)  
Description Public Bid Opening will be held virtually via Zoom conferencing. All bids are to be submitted electronically and are due by 2 pm CT. No late bids will be accepted - NO EXCEPTIONS!

Topic: RFP# 21/058MJ Energy Virtual Public Bid Opening  
Time: Jun 10, 2021 02:00 PM Central Time (US and Canada)

Join Zoom Meeting  
<https://zoom.us/j/94542762946?pwd=TmZzVnN5bkZqUWF0eFhPQnBwTHY5UT09>

Meeting ID: 945 4276 2946  
Passcode: abP7hS

Anticipated Board Award

Activity Date 7/21/2021 02:00:00 PM (CT)  
Description

**Regular Board Meeting****8.E.9.**

**Meeting Date:** July 21, 2021  
**Title:** Master Service Interlocal Agreement  
**Submitted For:** Joann Nichols, Choice Partners  
**Recommended Action:** Approve

**Submitted By:** Cora Day  
**HCDE Goal(s):** 4. Provide cost savings by leveraging tax dollars

**Additional Resource Personnel:** Joann Nichols, Jeff Drury, Richard Vela, Yaritza Roman, Kendra Jackson and Dr. Jesus Amezcua

**Facilities/Technology Approval Needed?:** None

**Information****Posted Agenda Item:**

**HCDE Interlocal Agreements with:** Barbers Hill ISD, Mont Belvieu, Texas - Signature Only; Deer Park ISD, Deer Park, Texas - Signature Only; Cisco ISD, Cisco, Texas; New Mexico State University (NMSU), Las Cruces, New Mexico - Signature Only, and Polk County, Livingston, Texas.

**Subject:**

HCDE Interlocal Agreement with:

Entity Name	Entity Type	City	State	Region
Barbers Hill ISD - Signature Only	School District (Outside of Harris County)	Mont Belvieu	TX	04
Deer Park ISD - Signature Only	School District (Outside of Harris County)	Deer Park	TX	04
Cisco ISD	School District (Outside of Harris County)	Cisco	TX	14
New Mexico State University - Signature Only	University	Las Cruces	NM	0
Polk County	County	Livingston	TX	06

**Rationale:**

HCDE Interlocal Agreement with:

Entity Name	Entity Type	City	State	Region
Barbers Hill ISD - Signature Only	School District (Outside of Harris County)	Mont Belvieu	TX	04
Deer Park ISD - Signature Only	School District (Outside of Harris County)	Deer Park	TX	04
Cisco ISD	School District (Outside of Harris County)	Cisco	TX	14
New Mexico State University - Signature Only	University	Las Cruces	NM	0
Polk County	County	Livingston	TX	06

## Fiscal Impact

Included in FY budget Y/N:

Y

Included in current budget amendment Y/N: N

---

## Attachments

Barbers Hill ISD

Cisco ISD

Deer Park ISD

NMSU

Polk County

Interlocal Map

---

## Form Review

### Inbox

Choice Partners

Purchasing

Assistant Superintendent - Business

Form Started By: Cora Day

Final Approval Date: 07/06/2021

### Reviewed By

Jeff Drury

Kendra Jackson

Venetia Baldwin

### Date

06/24/2021 05:23 PM

06/30/2021 08:03 AM

07/06/2021 09:58 AM

Started On: 06/16/2021 10:46 AM

**Interlocal Agreement**  
**between Harris County Department of Education**  
& Barbers Hill Independent School District

Pursuant to the Interlocal Cooperation Act, Chapter 791 of the Texas Government Code, and Chapter 271, Subchapter F of the Texas Local Government Code, and other similar, applicable laws of other states, this Interlocal Agreement (“Agreement”) is made and entered into by and between Harris County Department of Education (“HCDE”), located in Houston, Texas, and Barbers Hill ISD, a local governmental entity and/or political subdivision (“LGE”), located in Mont Belvieu (city), Texas (state), for the purpose of contracting for the performance of governmental functions and services. The undersigned may be referred to in this Agreement individually as a “Party” and collectively as the “Parties.”

**Preamble**

HCDE is a local governmental entity established to promote education in Harris County, Texas and is duly authorized to provide programs and services in the State of Texas. Both HCDE and LGE desire to set forth, in writing, the terms and conditions of their agreement.

**General Terms and Conditions**

In consideration of the mutual covenants and conditions contained in this Agreement and other good and valuable consideration, the receipt and sufficiency of which are hereby acknowledged, the parties, intending to be legally bound, agree as follows:

1. **Term.** The term of this Agreement shall commence on the date of the first signature of this Agreement (“Effective Date”) and shall automatically renew annually, unless either Party gives thirty (30) days prior written notice of non-renewal.
2. **Agreement.** The terms of this Agreement shall apply and will be considered a part of any addendum, purchase order, or contract for programs and services delivered by HCDE. This Agreement and the attached and incorporated addenda, purchase orders, or exhibits, if any, contain the entire agreement of the parties, and there are no representations, agreements, arrangements, or undertakings, oral or written, between the Parties to this Agreement other than those set forth in this Agreement and duly executed in writing.
3. **Purpose and Scope of Work.**
  - A. **HCDE agrees to:**
    - Provide LGE with descriptive offerings of each of the programs and services that HCDE provides.
    - Provide programs and services upon LGE’s submission of independent contracts or purchase orders to HCDE and HCDE’s acceptance thereof. HCDE’s obligations to provide programs and services is contingent on HCDE acquiring and maintaining sufficient staffing through reasonable efforts to satisfy HCDE’s obligations under this Agreement and all similar obligations under its contracts with other local governmental entities.
    - Conduct, at a minimum, an annual audit or survey, as appropriate, for each of the programs and services that HCDE delivers.
  - B. **LGE agrees to:**
    - Participate in any or all of the programs and services that HCDE offers, in LGE’s sole discretion.

- Submit purchase order(s) or independent contract(s) for each of the HCDE programs and/or services that LGE desires to purchase and/or collaborate.
  - Agree to follow the terms and conditions of each independent contract or purchase order.
  - Designate a person to act as LGE's representative to each respective HCDE program and/or service delivered.
4. As is. HCDE makes this Agreement available to HCDE participating entities "as is" and is under no obligation to revise the terms, conditions, scope, prices, and/or any requirements of the Agreement for the benefit of LGE.
5. Master Contract. This Agreement can be utilized as a Master Contract. The general terms and conditions in this Agreement will serve to outline the working relationship between HCDE and LGE.

LGE agrees to adhere to the specific terms and conditions set forth for the HCDE programs and/or services as contracted by LGE. In the case of a conflict between this Agreement and any addendum, purchase order, or individual contract for a specific HCDE program or service, the provisions of the addendum, purchase order, or individual contract will govern.

6. Payments. The Parties agree that all payments made under this Agreement will be in an amount that fairly compensates the performing Party for the services or functions performed under this Agreement. The Parties further agree that each Party paying for the performance of governmental functions or services pursuant to this Agreement must make those payments from current revenues available to the paying Party.
7. Invoices. HCDE will invoice LGE for the HCDE programs and services that LGE purchases from HCDE. LGE agrees to remit payment to HCDE within thirty (30) days after the later of the following: (1) the date LGE receives the goods; (2) the date the performance of the service is completed; or (3) the date LGE receives an invoice for the goods or service. If LGE makes a payment to HCDE with a credit card, LGE agrees to pay to HCDE a surcharge fee consisting of any applicable credit card fees and/or costs incurred by HCDE, including, without limitation, the processing fee(s) charged to HCDE by the credit card company(ies).
8. Participation in HCDE's Cooperative Purchasing Program. If LGE elects to participate in HCDE's cooperative purchasing program, Choice Partners, LGE shall be permitted to purchase goods and services using the contracts competitively procured by HCDE. HCDE does not assess a fee to LGE for participation in Choice Partners. LGE shall make payments directly to vendors. LGE shall be responsible for ordering, inspecting, and accepting the goods and services purchased through Choice Partners. LGE shall further be responsible for the vendors' compliance with provisions relating to the specific quality of goods and services delivered and terms of delivered, as set forth between LGE and the vendor. HCDE is not responsible or liable for the performance of any vendor used by LGE as a result of this Agreement or LGE's participation in Choice Partners.
9. Compliance with Laws. Each Party is responsible for complying with applicable laws and regulations relating to this Agreement and any purchase made under this Agreement.

10. Termination. This Agreement may be terminated prior to the expiration of the Term hereof as follows:
- By either Party, with or without cause, upon thirty (30) days' prior written notice;
  - By mutual written agreement of the Parties; or
  - By either Party immediately if the other Party commits a material breach of any of the terms of this Agreement and no remedial action can be agreed upon by the Parties.

Termination of this Agreement by a Party shall not terminate an existing purchase order or individual contract between HCDE and LGE or between LGE and an HCDE cooperative purchasing program vendor. In the event of termination of this Agreement or any purchase order or individual contract, LGE shall be responsible for compensating HCDE for programs and services provided by HCDE up to the effective date of termination.

11. Assignment. Neither this Agreement nor any duties or obligations entered in subsequent contracts because of this agreement shall be assignable by either party without the prior written acknowledgment and authorization of both parties.
12. Conflict of Interest. During the Term of HCDE's service to LGE, LGE, its personnel and agents, shall not, directly or indirectly, whether for LGE's own account or with any other person or entity whatsoever, employ, solicit or endeavor to entice away any person who is employed by HCDE.
13. Contract Amendment. This Agreement may be amended only by the mutual agreement of all Parties, in writing, to be attached to and incorporated into this Agreement.
14. Notice. Any notice provided under the terms of this Agreement by either party to the other shall be in writing and shall be sent by **certified mail, return receipt requested**. Notice to shall be sufficient if made or addressed as follows:

Harris County Department of Education  
 Attn: James Colbert, Jr.  
 County School Superintendent  
 6300 Irvington Blvd.  
 Houston, Texas 77022  
 713-694-6300

Barbers Hill Independent School District ("LGE")  
 Attn: Becky McManus  
 Title: Assistant Superintendent of Finance  
 Address: PO Box 1108  
 City, State, Zip: Mont Belvieu, TX 77580  
 Phone: 281-576-2221  
 Email: bmcmanus@bhisd.net

15. Relation of Parties. It is the intention of the parties that LGE is independent of HCDE and not an employee, agent, joint venturer, or partner of HCDE and nothing in this Agreement shall be interpreted or construed as creating or establishing the relationship of employer and employee, agent, joint venturer or partner, between HCDE and LGE or HCDE and any of LGE's representatives.
16. Non-Exclusivity of Services. Nothing in this Agreement may be construed to imply that HCDE has exclusive right to provide LGE with programs or services. During the Term of this Agreement, LGE reserves the right to use all available resources to procure other programs and services as needed and, in doing so, will not violate any rights of HCDE.

17. Disclaimer. HCDE DOES NOT WARRANT THAT THE OPERATION OR USE OF HCDE PROGRAMS AND/OR SERVICES WILL BE UNINTERRUPTED OR ERROR FREE. HCDE HEREBY DISCLAIMS ANY AND ALL WARRANTIES, EXPRESS OR IMPLIED, IN REGARD TO ANY INFORMATION, PRODUCT, PROGRAM, OR SERVICE FURNISHED UNDER THIS AGREEMENT, INCLUDING, WITHOUT LIMITATION, ANY AND ALL IMPLIED WARRANTIES OF MERCHANTABILITY OR FITNESS FOR A PARTICULAR PURPOSE.
18. Limitation of Liability. Without waiver of the Disclaimer in Article 17 of this Agreement, the Parties agree that:
  - Neither Party waives any immunity afforded to it under applicable law; and
  - Neither Party shall be liable to the other Party for special, incidental, or exemplary damages with regard to any lawsuit or formal adjudication arising out of or relating to this Agreement.
19. Severability. In the event that any one or more of the provisions contained in this Agreement shall for any reason be held to be invalid, illegal, or unenforceable in any respect, such invalidity, illegality, or unenforceability shall not affect any other provisions, and the Agreement shall be construed as if such invalid, illegality, or unenforceable provision had never been contained in it.
20. Governing Law and Venue. This Agreement shall be governed by and construed in accordance with the laws of the State of Texas, without regard to its conflicts of laws provisions. The mandatory and exclusive venue for the adjudication or resolution of any dispute arising out of this Agreement shall be in Houston, Harris County, Texas.
21. No Waiver. Nothing in this Agreement shall be deemed to waive, modify, or amend any legal defense available at law or equity to a Party, including the defense(s) of immunity. No failure on the part of either Party at any time to require the performance by the other Party of any term hereof shall be taken or held to be a waiver of such term or in any way affect such Party's right to enforce such term, and no waiver on the part of either Party of any term hereof shall be taken or held to be a waiver of any other term hereof or the breach thereof. No waiver, alteration, or modification of any of the provisions of this Agreement shall be binding unless in writing and signed by duly authorized representatives of the Parties hereto.
22. Benefit for Signatory Parties Only. Neither this Agreement, nor any term or provisions hereof, not any inclusion by reference, shall be construed as being for the benefit of any party not in signatory hereto.
23. Authorization. Each party acknowledges that the governing body of each Party to the Agreement has authorized and approved this Agreement.
24. Counterparts. This Agreement may be executed in any number of counterparts, each of which shall be deemed an original constituting one and the same instrument.

In witness whereof, HCDE and LGE have executed this Agreement to be effective on the date specified in Article 1. Term above:

**Barbers Hill ISD**

Name of Local Governmental Entity

  
Authorized Signature

**George Barrera**

Printed Name

**President, Board of Trustees**

Title

**April 26, 2021**

Date

Harris County Department of Education

James Colbert, Jr.

County School Superintendent

Date

Type of Local Governmental Entity (*select one*):

- School District       Charter School
- County                       City/Municipality
- University                   College
- State Entity
- Governmental entity/other: \_\_\_\_\_



**Interlocal Agreement**  
**between Harris County Department of Education**  
**& CISCO INDEPENDENT SCHOOL DISTRICT**

Pursuant to the Interlocal Cooperation Act, Chapter 791 of the Texas Government Code, and Chapter 271, Subchapter F of the Texas Local Government Code, and other similar, applicable laws of other states, this Interlocal Agreement (“Agreement”) is made and entered into by and between Harris County Department of Education (“HCDE”), located in Houston, Texas, and Cisco Independent School District, a local governmental entity and/or political subdivision (“LGE”), located in Cisco (city), Texas (state), for the purpose of contracting for the performance of governmental functions and services. The undersigned may be referred to in this Agreement individually as a “Party” and collectively as the “Parties.”

**Preamble**

HCDE is a local governmental entity established to promote education in Harris County, Texas and is duly authorized to provide programs and services in the State of Texas. Both HCDE and LGE desire to set forth, in writing, the terms and conditions of their agreement.

**General Terms and Conditions**

In consideration of the mutual covenants and conditions contained in this Agreement and other good and valuable consideration, the receipt and sufficiency of which are hereby acknowledged, the parties, intending to be legally bound, agree as follows:

1. **Term.** The term of this Agreement shall commence on the date of the first signature of this Agreement (“Effective Date”) and shall automatically renew annually, unless either Party gives thirty (30) days prior written notice of non-renewal.
2. **Agreement.** The terms of this Agreement shall apply and will be considered a part of any addendum, purchase order, or contract for programs and services delivered by HCDE. This Agreement and the attached and incorporated addenda, purchase orders, or exhibits, if any, contain the entire agreement of the parties, and there are no representations, agreements, arrangements, or undertakings, oral or written, between the Parties to this Agreement other than those set forth in this Agreement and duly executed in writing.
3. **Purpose and Scope of Work.**
  - A. **HCDE agrees to:**
    - Provide LGE with descriptive offerings of each of the programs and services that HCDE provides.
    - Provide programs and services upon LGE’s submission of independent contracts or purchase orders to HCDE and HCDE’s acceptance thereof. HCDE’s obligations to provide programs and services is contingent on HCDE acquiring and maintaining sufficient staffing through reasonable efforts to satisfy HCDE’s obligations under this Agreement and all similar obligations under its contracts with other local governmental entities.
    - Conduct, at a minimum, an annual audit or survey, as appropriate, for each of the programs and services that HCDE delivers.
  - B. **LGE agrees to:**
    - Participate in any or all of the programs and services that HCDE offers, in LGE’s sole discretion.

- Submit purchase order(s) or independent contract(s) for each of the HCDE programs and/or services that LGE desires to purchase and/or collaborate.
  - Agree to follow the terms and conditions of each independent contract or purchase order.
  - Designate a person to act as LGE's representative to each respective HCDE program and/or service delivered.
4. As is. HCDE makes this Agreement available to HCDE participating entities "as is" and is under no obligation to revise the terms, conditions, scope, prices, and/or any requirements of the Agreement for the benefit of LGE.
5. Master Contract. This Agreement can be utilized as a Master Contract. The general terms and conditions in this Agreement will serve to outline the working relationship between HCDE and LGE.

LGE agrees to adhere to the specific terms and conditions set forth for the HCDE programs and/or services as contracted by LGE. In the case of a conflict between this Agreement and any addendum, purchase order, or individual contract for a specific HCDE program or service, the provisions of the addendum, purchase order, or individual contract will govern.

6. Payments. The Parties agree that all payments made under this Agreement will be in an amount that fairly compensates the performing Party for the services or functions performed under this Agreement. The Parties further agree that each Party paying for the performance of governmental functions or services pursuant to this Agreement must make those payments from current revenues available to the paying Party.
7. Invoices. HCDE will invoice LGE for the HCDE programs and services that LGE purchases from HCDE. LGE agrees to remit payment to HCDE within thirty (30) days after the later of the following: (1) the date LGE receives the goods; (2) the date the performance of the service is completed; or (3) the date LGE receives an invoice for the goods or service. If LGE makes a payment to HCDE with a credit card, LGE agrees to pay to HCDE a surcharge fee consisting of any applicable credit card fees and/or costs incurred by HCDE, including, without limitation, the processing fee(s) charged to HCDE by the credit card company(ies).
8. Participation in HCDE's Cooperative Purchasing Program. If LGE elects to participate in HCDE's cooperative purchasing program, Choice Partners, LGE shall be permitted to purchase goods and services using the contracts competitively procured by HCDE. HCDE does not assess a fee to LGE for participation in Choice Partners. LGE shall make payments directly to vendors. LGE shall be responsible for ordering, inspecting, and accepting the goods and services purchased through Choice Partners. LGE shall further be responsible for the vendors' compliance with provisions relating to the specific quality of goods and services delivered and terms of delivered, as set forth between LGE and the vendor. HCDE is not responsible or liable for the performance of any vendor used by LGE as a result of this Agreement or LGE's participation in Choice Partners.
9. Compliance with Laws. Each Party is responsible for complying with applicable laws and regulations relating to this Agreement and any purchase made under this Agreement.

10. Termination. This Agreement may be terminated prior to the expiration of the Term hereof as follows:

- By either Party, with or without cause, upon thirty (30) days' prior written notice;
- By mutual written agreement of the Parties; or
- By either Party immediately if the other Party commits a material breach of any of the terms of this Agreement and no remedial action can be agreed upon by the Parties.

Termination of this Agreement by a Party shall not terminate an existing purchase order or individual contract between HCDE and LGE or between LGE and an HCDE cooperative purchasing program vendor. In the event of termination of this Agreement or any purchase order or individual contract, LGE shall be responsible for compensating HCDE for programs and services provided by HCDE up to the effective date of termination.

11. Assignment. Neither this Agreement nor any duties or obligations entered in subsequent contracts because of this agreement shall be assignable by either party without the prior written acknowledgment and authorization of both parties.

12. Conflict of Interest. During the Term of HCDE's service to LGE, LGE, its personnel and agents, shall not, directly or indirectly, whether for LGE's own account or with any other person or entity whatsoever, employ, solicit or endeavor to entice away any person who is employed by HCDE.

13. Contract Amendment. This Agreement may be amended only by the mutual agreement of all Parties, in writing, to be attached to and incorporated into this Agreement.

14. Notice. Any notice provided under the terms of this Agreement by either party to the other shall be in writing and shall be sent by **certified mail, return receipt requested**. Notice to shall be sufficient if made or addressed as follows:

Harris County Department of Education  
Attn: James Colbert, Jr.  
County School Superintendent  
6300 Irvington Blvd.  
Houston, Texas 77022  
713-694-6300

Cisco Independent School District ("LGE")  
Attn: Dr. Ryan Steele  
Title: Superintendent  
Address: P.O. Box 1645  
City, State, Zip: Cisco, Texas 76437  
Phone: 254-442-3056  
Email: rsteale@cisco.esc14.net

15. Relation of Parties. It is the intention of the parties that LGE is independent of HCDE and not an employee, agent, joint venturer, or partner of HCDE and nothing in this Agreement shall be interpreted or construed as creating or establishing the relationship of employer and employee, agent, joint venturer or partner, between HCDE and LGE or HCDE and any of LGE's representatives.

16. Non-Exclusivity of Services. Nothing in this Agreement may be construed to imply that HCDE has exclusive right to provide LGE with programs or services. During the Term of this Agreement, LGE reserves the right to use all available resources to procure other programs and services as needed and, in doing so, will not violate any rights of HCDE.

17. Disclaimer. HCDE DOES NOT WARRANT THAT THE OPERATION OR USE OF HCDE PROGRAMS AND/OR SERVICES WILL BE UNINTERRUPTED OR ERROR FREE. HCDE HEREBY DISCLAIMS ANY AND ALL WARRANTIES, EXPRESS OR IMPLIED, IN REGARD TO ANY INFORMATION, PRODUCT, PROGRAM, OR SERVICE FURNISHED UNDER THIS AGREEMENT, INCLUDING, WITHOUT LIMITATION, ANY AND ALL IMPLIED WARRANTIES OF MERCHANTABILITY OR FITNESS FOR A PARTICULAR PURPOSE.
18. Limitation of Liability. Without waiver of the Disclaimer in Article 17 of this Agreement, the Parties agree that:
  - Neither Party waives any immunity afforded to it under applicable law; and
  - Neither Party shall be liable to the other Party for special, incidental, or exemplary damages with regard to any lawsuit or formal adjudication arising out of or relating to this Agreement.
19. Severability. In the event that any one or more of the provisions contained in this Agreement shall for any reason be held to be invalid, illegal, or unenforceable in any respect, such invalidity, illegality, or unenforceability shall not affect any other provisions, and the Agreement shall be construed as if such invalid, illegality, or unenforceable provision had never been contained in it.
20. Governing Law and Venue. This Agreement shall be governed by and construed in accordance with the laws of the State of Texas, without regard to its conflicts of laws provisions. The mandatory and exclusive venue for the adjudication or resolution of any dispute arising out of this Agreement shall be in Houston, Harris County, Texas.
21. No Waiver. Nothing in this Agreement shall be deemed to waive, modify, or amend any legal defense available at law or equity to a Party, including the defense(s) of immunity. No failure on the part of either Party at any time to require the performance by the other Party of any term hereof shall be taken or held to be a waiver of such term or in any way affect such Party's right to enforce such term, and no waiver on the part of either Party of any term hereof shall be taken or held to be a waiver of any other term hereof or the breach thereof. No waiver, alteration, or modification of any of the provisions of this Agreement shall be binding unless in writing and signed by duly authorized representatives of the Parties hereto.
22. Benefit for Signatory Parties Only. Neither this Agreement, nor any term or provisions hereof, not any inclusion by reference, shall be construed as being for the benefit of any party not in signatory hereto.
23. Authorization. Each party acknowledges that the governing body of each Party to the Agreement has authorized and approved this Agreement.
24. Counterparts. This Agreement may be executed in any number of counterparts, each of which shall be deemed an original constituting one and the same instrument.

In witness whereof, HCDE and LGE have executed this Agreement to be effective on the date specified in Article 1. Term above:

Cisco I.S.D.

Name of Local Governmental Entity

*Ryan Steele*  
Authorized Signature

Dr. Ryan Steele

Printed Name

Superintendent

Title

4/17/21  
Date

Harris County Department of Education

James Colbert, Jr.

County School Superintendent

Date

Type of Local Governmental Entity (*select one*):

- School District       Charter School
- County                       City/Municipality
- University                   College
- State Entity
- Governmental entity/other: \_\_\_\_\_

**Interlocal Agreement**  
**between Harris County Department of Education**  
**& Deer Park ISD**

Pursuant to the Interlocal Cooperation Act, Chapter 791 of the Texas Government Code, and Chapter 271, Subchapter F of the Texas Local Government Code, and other similar, applicable laws of other states, this Interlocal Agreement (“Agreement”) is made and entered into by and between Harris County Department of Education (“HCDE”), located in Houston, Texas, and Deer Park ISD, a local governmental entity and/or political subdivision (“LGE”), located in Deer Park (city), Texas (state), for the purpose of contracting for the performance of governmental functions and services. The undersigned may be referred to in this Agreement individually as a “Party” and collectively as the “Parties.”

**Preamble**

HCDE is a local governmental entity established to promote education in Harris County, Texas and is duly authorized to provide programs and services in the State of Texas. Both HCDE and LGE desire to set forth, in writing, the terms and conditions of their agreement.

**General Terms and Conditions**

In consideration of the mutual covenants and conditions contained in this Agreement and other good and valuable consideration, the receipt and sufficiency of which are hereby acknowledged, the parties, intending to be legally bound, agree as follows:

1. **Term.** The term of this Agreement shall commence on the date of the first signature of this Agreement (“Effective Date”) and shall automatically renew annually, unless either Party gives thirty (30) days prior written notice of non-renewal.
2. **Agreement.** The terms of this Agreement shall apply and will be considered a part of any addendum, purchase order, or contract for programs and services delivered by HCDE. This Agreement and the attached and incorporated addenda, purchase orders, or exhibits, if any, contain the entire agreement of the parties, and there are no representations, agreements, arrangements, or undertakings, oral or written, between the Parties to this Agreement other than those set forth in this Agreement and duly executed in writing.
3. **Purpose and Scope of Work.**
  - A. **HCDE agrees to:**
    - Provide LGE with descriptive offerings of each of the programs and services that HCDE provides.
    - Provide programs and services upon LGE’s submission of independent contracts or purchase orders to HCDE and HCDE’s acceptance thereof. HCDE’s obligations to provide programs and services is contingent on HCDE acquiring and maintaining sufficient staffing through reasonable efforts to satisfy HCDE’s obligations under this Agreement and all similar obligations under its contracts with other local governmental entities.
    - Conduct, at a minimum, an annual audit or survey, as appropriate, for each of the programs and services that HCDE delivers.
  - B. **LGE agrees to:**
    - Participate in any or all of the programs and services that HCDE offers, in LGE’s sole discretion.

- Submit purchase order(s) or independent contract(s) for each of the HCDE programs and/or services that LGE desires to purchase and/or collaborate.
  - Agree to follow the terms and conditions of each independent contract or purchase order.
  - Designate a person to act as LGE's representative to each respective HCDE program and/or service delivered.
4. As is. HCDE makes this Agreement available to HCDE participating entities "as is" and is under no obligation to revise the terms, conditions, scope, prices, and/or any requirements of the Agreement for the benefit of LGE.
5. Master Contract. This Agreement can be utilized as a Master Contract. The general terms and conditions in this Agreement will serve to outline the working relationship between HCDE and LGE.

LGE agrees to adhere to the specific terms and conditions set forth for the HCDE programs and/or services as contracted by LGE. In the case of a conflict between this Agreement and any addendum, purchase order, or individual contract for a specific HCDE program or service, the provisions of the addendum, purchase order, or individual contract will govern.

6. Payments. The Parties agree that all payments made under this Agreement will be in an amount that fairly compensates the performing Party for the services or functions performed under this Agreement. The Parties further agree that each Party paying for the performance of governmental functions or services pursuant to this Agreement must make those payments from current revenues available to the paying Party.
7. Invoices. HCDE will invoice LGE for the HCDE programs and services that LGE purchases from HCDE. LGE agrees to remit payment to HCDE within thirty (30) days after the later of the following: (1) the date LGE receives the goods; (2) the date the performance of the service is completed; or (3) the date LGE receives an invoice for the goods or service. If LGE makes a payment to HCDE with a credit card, LGE agrees to pay to HCDE a surcharge fee consisting of any applicable credit card fees and/or costs incurred by HCDE, including, without limitation, the processing fee(s) charged to HCDE by the credit card company(ies).
8. Participation in HCDE's Cooperative Purchasing Program. If LGE elects to participate in HCDE's cooperative purchasing program, Choice Partners, LGE shall be permitted to purchase goods and services using the contracts competitively procured by HCDE. HCDE does not assess a fee to LGE for participation in Choice Partners. LGE shall make payments directly to vendors. LGE shall be responsible for ordering, inspecting, and accepting the goods and services purchased through Choice Partners. LGE shall further be responsible for the vendors' compliance with provisions relating to the specific quality of goods and services delivered and terms of delivered, as set forth between LGE and the vendor. HCDE is not responsible or liable for the performance of any vendor used by LGE as a result of this Agreement or LGE's participation in Choice Partners.
9. Compliance with Laws. Each Party is responsible for complying with applicable laws and regulations relating to this Agreement and any purchase made under this Agreement.

10. Termination. This Agreement may be terminated prior to the expiration of the Term hereof as follows:
- By either Party, with or without cause, upon thirty (30) days' prior written notice;
  - By mutual written agreement of the Parties; or
  - By either Party immediately if the other Party commits a material breach of any of the terms of this Agreement and no remedial action can be agreed upon by the Parties.

Termination of this Agreement by a Party shall not terminate an existing purchase order or individual contract between HCDE and LGE or between LGE and an HCDE cooperative purchasing program vendor. In the event of termination of this Agreement or any purchase order or individual contract, LGE shall be responsible for compensating HCDE for programs and services provided by HCDE up to the effective date of termination.

11. Assignment. Neither this Agreement nor any duties or obligations entered in subsequent contracts because of this agreement shall be assignable by either party without the prior written acknowledgment and authorization of both parties.
12. Conflict of Interest. During the Term of HCDE's service to LGE, LGE, its personnel and agents, shall not, directly or indirectly, whether for LGE's own account or with any other person or entity whatsoever, employ, solicit or endeavor to entice away any person who is employed by HCDE.
13. Contract Amendment. This Agreement may be amended only by the mutual agreement of all Parties, in writing, to be attached to and incorporated into this Agreement.
14. Notice. Any notice provided under the terms of this Agreement by either party to the other shall be in writing and shall be sent by **certified mail, return receipt requested**. Notice to shall be sufficient if made or addressed as follows:

Harris County Department of Education  
 Attn: James Colbert, Jr.  
 County School Superintendent  
 6300 Irvington Blvd.  
 Houston, Texas 77022  
 713-694-6300

Deer Park IS D ("LGE")  
 Attn: John Knowlton  
 Title: Director of Purchasing  
 Address: 2800 Texas Ave  
 City, State, Zip: Deer Park Tx 77536  
 Phone: 832-668-7061  
 Email: knowlton@dpsid.org

15. Relation of Parties. It is the intention of the parties that LGE is independent of HCDE and not an employee, agent, joint venturer, or partner of HCDE and nothing in this Agreement shall be interpreted or construed as creating or establishing the relationship of employer and employee, agent, joint venturer or partner, between HCDE and LGE or HCDE and any of LGE's representatives.
16. Non-Exclusivity of Services. Nothing in this Agreement may be construed to imply that HCDE has exclusive right to provide LGE with programs or services. During the Term of this Agreement, LGE reserves the right to use all available resources to procure other programs and services as needed and, in doing so, will not violate any rights of HCDE.



17. Disclaimer. HCDE DOES NOT WARRANT THAT THE OPERATION OR USE OF HCDE PROGRAMS AND/OR SERVICES WILL BE UNINTERRUPTED OR ERROR FREE. HCDE HEREBY DISCLAIMS ANY AND ALL WARRANTIES, EXPRESS OR IMPLIED, IN REGARD TO ANY INFORMATION, PRODUCT, PROGRAM, OR SERVICE FURNISHED UNDER THIS AGREEMENT, INCLUDING, WITHOUT LIMITATION, ANY AND ALL IMPLIED WARRANTIES OF MERCHANTABILITY OR FITNESS FOR A PARTICULAR PURPOSE.
18. Limitation of Liability. Without waiver of the Disclaimer in Article 17 of this Agreement, the Parties agree that:
  - Neither Party waives any immunity afforded to it under applicable law; and
  - Neither Party shall be liable to the other Party for special, incidental, or exemplary damages with regard to any lawsuit or formal adjudication arising out of or relating to this Agreement.
19. Severability. In the event that any one or more of the provisions contained in this Agreement shall for any reason be held to be invalid, illegal, or unenforceable in any respect, such invalidity, illegality, or unenforceability shall not affect any other provisions, and the Agreement shall be construed as if such invalid, illegality, or unenforceable provision had never been contained in it.
20. Governing Law and Venue. This Agreement shall be governed by and construed in accordance with the laws of the State of Texas, without regard to its conflicts of laws provisions. The mandatory and exclusive venue for the adjudication or resolution of any dispute arising out of this Agreement shall be in Houston, Harris County, Texas.
21. No Waiver. Nothing in this Agreement shall be deemed to waive, modify, or amend any legal defense available at law or equity to a Party, including the defense(s) of immunity. No failure on the part of either Party at any time to require the performance by the other Party of any term hereof shall be taken or held to be a waiver of such term or in any way affect such Party's right to enforce such term, and no waiver on the part of either Party of any term hereof shall be taken or held to be a waiver of any other term hereof or the breach thereof. No waiver, alteration, or modification of any of the provisions of this Agreement shall be binding unless in writing and signed by duly authorized representatives of the Parties hereto.
22. Benefit for Signatory Parties Only. Neither this Agreement, nor any term or provisions hereof, not any inclusion by reference, shall be construed as being for the benefit of any party not in signatory hereto.
23. Authorization. Each party acknowledges that the governing body of each Party to the Agreement has authorized and approved this Agreement.
24. Counterparts. This Agreement may be executed in any number of counterparts, each of which shall be deemed an original constituting one and the same instrument.

In witness whereof, HCDE and LGE have executed this Agreement to be effective on the date specified in Article 1. Term above:

Deer Park ISD  
Name of Local Governmental Entity

Harris County Department of Education

David Edgar  
Authorized Signature

\_\_\_\_\_

**David Edgar**  
Printed Name

James Colbert, Jr.

Assistant Superintendent for Business Services  
Title

County School Superintendent

12/14/2020  
Date

\_\_\_\_\_ Date

Type of Local Governmental Entity (*select one*):

- School District       Charter School
- County                       City/Municipality
- University                   College
- State Entity
- Governmental entity/other: \_\_\_\_\_

**Interlocal Contract - Interstate**  
**Between Harris County Department of Education**  
& Regents of New Mexico State University

Pursuant to the Interlocal Cooperation Act, Chapter 791 of the Texas Government Code, this Interstate Contract (“Contract”) is made and entered into by and between the Harris County Department of Education (“HCDE”), located in Houston, Texas, and the Regents of New Mexico State University (“Entity”), located in Las Cruces, New Mexico, for the purpose of allowing Entity to purchase services under the same terms, conditions, and prices as are available to all participants of HCDE’s Choice Partners cooperative.

**Preamble**

HCDE is a local governmental entity established to promote education in Harris County, Texas and is also duly authorized to provide programs and services in the State of Texas and to agencies of other states, pursuant to Texas Government Code § 791.011(b)(2). Both HCDE and Entity desire to set forth, in writing, the terms and conditions of their agreement.

**General Terms and Conditions**

In consideration of the mutual covenants and conditions contained in this Contract and other good and valuable consideration, the receipt and sufficiency of which are hereby acknowledged, the parties intending to be legally bound agree as follows:

1. **Term.** This Contract is effective from the date of the first signature and shall automatically renew unless either party gives thirty (30) days prior written notice of non-renewal. This Contract may be terminated by either party with or without cause with thirty (30) days written notice. See other means of terminating the contract in Article 11, below. Any such notice shall be sent according to Article 8.
2. **Agreement.** The terms of this Contract shall apply and will be considered a part of any Addendum for programs and services delivered by HCDE. This Contract and the attached and incorporated Addendum, purchase orders, or exhibits, if any, contain the entire agreement of the parties and there are no representations, agreements, arrangements, or undertakings, oral or written, between the parties to this Contract other than those set forth in this Contract and duly executed in writing.
3. **Purpose and Scope of Work.**
  - A. HCDE:**
    - Represents that it has secured the vendor(s)’ agreement to provide commodities and/or services to its non-Texas members under the terms, conditions, and prices as contracted for Texas governmental entities.
    - Represents that it has reviewed the contract(s) and determined that it complies with any and all applicable rules, regulations, and statutes applicable to competitive procurement and cooperative purchasing in the State of Texas.
  - B. Entity:**
    - Agrees that it is Entity’s responsibility to ensure that its State’s rules, regulations, and statutes applicable to competitive procurement and cooperative purchasing allow Entity’s participation in out-of-state contracts.
    - Agrees that it shall issue any and all purchase orders or other applicable authorizations for purchases made on its behalf to Choice Partner’s vendors.
    - Agrees that it shall provide Choice Partners with a copy of any contract or purchase order based on a Choice Partners contract.

- Agrees to follow the terms and conditions of each independent contract or purchase orders for each Choice Partner vendor.
4. As is. HCDE makes this Contract available to Choice Partners participating entities “as is” and are under no obligation to revise the terms, conditions, scope, prices, and/or any other requirements of the Contract for the benefit of Entity.
  5. Assignment. Neither this Contract nor any duties or obligations entered in subsequent contracts because of this agreement shall be assignable by either party without the prior written acknowledgment and authorization of both parties.
  6. Conflict of Interest. During the Term of HCDE’s service to Entity, Entity, its personnel and agents, shall not, directly or indirectly, whether for Entity’s own account or with any other person or entity whatsoever, employ, solicit or endeavor to entice away any person who is employed by HCDE.
  7. Contract Amendment. This Contract shall not be altered, changed, or amended except by the mutual agreement of all parties in writing to be attached to and incorporated into this Contract.
  8. Notice. Any notice provided under the terms of this Contract by either party to the other shall be in writing and shall be sent by **certified mail, return receipt requested**. Notice to shall be sufficient if made or addressed as follows:

Harris County Department of Education  
 Attn: James Colbert, Jr.  
 County School Superintendent  
 6300 Irvington Blvd.  
 Houston, Texas 77022  
 Phone: 713-694-6300

Entity: Regent of New Mexico State University  
 Attn: Javier Cordero  
 Title: Director, Procurement Services  
 Address: MSC 3890, PO Box 30001  
 City, State, Zip: Las Cruces, NM 88003-3890  
 Phone: (575) 646-2916  
 Email: javierco@nmsu.edu

9. Relation of Parties. It is the intention of the parties that Entity is independent of HCDE and is not an employee, agent, joint venturer, or partner of HCDE and nothing in this Contract shall be interpreted or construed as creating or establishing the relationship of employer and employee, agent, joint venturer or partner, between HCDE and Entity or HCDE and any of Entity’s agents.
10. Non-Exclusivity of Services. Nothing in this Contract may be construed to imply that HCDE has exclusive right to provide Entity these services. During the Term of Contract, Entity reserves the right to use all available resources to procure other services as needed and, in doing so, will not violate any rights of HCDE.
11. Termination. This Contract may be terminated prior to the expiration of the Term hereof as follows:
  - By Entity upon 30 days notice if the work/service is not provided in a satisfactory and proper manner after a remedy has been reported and discussed;
  - By mutual written agreement of the parties, upon thirty (30) days prior notice;
  - By either party by giving thirty (30) days written notice to the other party; or
  - By either party immediately if the other party commits a material breach any of the terms of this Contract and no remedial action can be agreed upon by the parties.
12. Master Contract. This Contract can be utilized as the Master Contract. The general terms and conditions in this Contract will serve to outline the working relationship between HCDE and

Entity. Both parties agree to allow the Entity to use any or all of the following programs and/or services with no charge from HCDE including Choice Partners.

Entity agrees to adhere to the terms and conditions set forth for the programs and/or services as contracted under these programs. All other programs and/or services provided by HCDE requiring a fee will need an addendum to the approved Master Interstate Contract. The specific terms and conditions of the addendum will govern that individual contract. In the case of a conflict between the Contract and any addendum, the provisions of the addendum will govern.

- 13. Severability. In the event that any one or more of the provisions contained in this Contract shall for any reason be held to be invalid, illegal, or unenforceable in any respect, such invalidity, illegality, or unenforceability shall not affect any other provisions, and the Contract shall be construed as if such invalid, illegality, or unenforceable provision had never been contained in it.
- 14. Authorization. Each party acknowledges that the governing body of each party to the Contract has authorized this Contract.
- 15. Benefit for Signatory Parties Only. Neither this Contract, nor any term or provisions hereof, nor any inclusion by reference, shall be construed as being for the benefit of any party not in signatory hereto.

In witness whereof, HCDE and Entity have executed this Contract to be effective on the date specified in Article 1. Term above:

Regents of New Mexico State University

Harris County Department of Education

Entity Name

Javier Cordero Digitally signed by Javier Cordero  
Date: 2021.06.21 18:34:21 -06'00'

Signature

Javier Cordero

James Colbert, Jr.

Printed Name

Director, Procurement Services

County School Superintendent

Title

Date

Date: \_\_\_\_\_

**Interlocal Agreement**  
**between Harris County Department of Education**  
& Polk County

Pursuant to the Interlocal Cooperation Act, Chapter 791 of the Texas Government Code, and Chapter 271, Subchapter F of the Texas Local Government Code, and other similar, applicable laws of other states, this Interlocal Agreement (“Agreement”) is made and entered into by and between Harris County Department of Education (“HCDE”), located in Houston, Texas, and Polk County, a local governmental entity and/or political subdivision (“LGE”), located in Livingston (city), Texas (state), for the purpose of contracting for the performance of governmental functions and services. The undersigned may be referred to in this Agreement individually as a “Party” and collectively as the “Parties.”

**Preamble**

HCDE is a local governmental entity established to promote education in Harris County, Texas and is duly authorized to provide programs and services in the State of Texas. Both HCDE and LGE desire to set forth, in writing, the terms and conditions of their agreement.

**General Terms and Conditions**

In consideration of the mutual covenants and conditions contained in this Agreement and other good and valuable consideration, the receipt and sufficiency of which are hereby acknowledged, the parties, intending to be legally bound, agree as follows:

1. **Term.** The term of this Agreement shall commence on the date of the first signature of this Agreement (“Effective Date”) and shall automatically renew annually, unless either Party gives thirty (30) days prior written notice of non-renewal.
2. **Agreement.** The terms of this Agreement shall apply and will be considered a part of any addendum, purchase order, or contract for programs and services delivered by HCDE. This Agreement and the attached and incorporated addenda, purchase orders, or exhibits, if any, contain the entire agreement of the parties, and there are no representations, agreements, arrangements, or undertakings, oral or written, between the Parties to this Agreement other than those set forth in this Agreement and duly executed in writing.
3. **Purpose and Scope of Work.**
  - A. **HCDE agrees to:**
    - Provide LGE with descriptive offerings of each of the programs and services that HCDE provides.
    - Provide programs and services upon LGE’s submission of independent contracts or purchase orders to HCDE and HCDE’s acceptance thereof. HCDE’s obligations to provide programs and services is contingent on HCDE acquiring and maintaining sufficient staffing through reasonable efforts to satisfy HCDE’s obligations under this Agreement and all similar obligations under its contracts with other local governmental entities.
    - Conduct, at a minimum, an annual audit or survey, as appropriate, for each of the programs and services that HCDE delivers.
  - B. **LGE agrees to:**
    - Participate in any or all of the programs and services that HCDE offers, in LGE’s sole discretion.

- Submit purchase order(s) or independent contract(s) for each of the HCDE programs and/or services that LGE desires to purchase and/or collaborate.
  - Agree to follow the terms and conditions of each independent contract or purchase order.
  - Designate a person to act as LGE's representative to each respective HCDE program and/or service delivered.
4. As is. HCDE makes this Agreement available to HCDE participating entities "as is" and is under no obligation to revise the terms, conditions, scope, prices, and/or any requirements of the Agreement for the benefit of LGE.
5. Master Contract. This Agreement can be utilized as a Master Contract. The general terms and conditions in this Agreement will serve to outline the working relationship between HCDE and LGE.

LGE agrees to adhere to the specific terms and conditions set forth for the HCDE programs and/or services as contracted by LGE. In the case of a conflict between this Agreement and any addendum, purchase order, or individual contract for a specific HCDE program or service, the provisions of the addendum, purchase order, or individual contract will govern.

6. Payments. The Parties agree that all payments made under this Agreement will be in an amount that fairly compensates the performing Party for the services or functions performed under this Agreement. The Parties further agree that each Party paying for the performance of governmental functions or services pursuant to this Agreement must make those payments from current revenues available to the paying Party.
7. Invoices. HCDE will invoice LGE for the HCDE programs and services that LGE purchases from HCDE. LGE agrees to remit payment to HCDE within thirty (30) days after the later of the following: (1) the date LGE receives the goods; (2) the date the performance of the service is completed; or (3) the date LGE receives an invoice for the goods or service. If LGE makes a payment to HCDE with a credit card, LGE agrees to pay to HCDE a surcharge fee consisting of any applicable credit card fees and/or costs incurred by HCDE, including, without limitation, the processing fee(s) charged to HCDE by the credit card company(ies).
8. Participation in HCDE's Cooperative Purchasing Program. If LGE elects to participate in HCDE's cooperative purchasing program, Choice Partners, LGE shall be permitted to purchase goods and services using the contracts competitively procured by HCDE. HCDE does not assess a fee to LGE for participation in Choice Partners. LGE shall make payments directly to vendors. LGE shall be responsible for ordering, inspecting, and accepting the goods and services purchased through Choice Partners. LGE shall further be responsible for the vendors' compliance with provisions relating to the specific quality of goods and services delivered and terms of delivered, as set forth between LGE and the vendor. HCDE is not responsible or liable for the performance of any vendor used by LGE as a result of this Agreement or LGE's participation in Choice Partners.
9. Compliance with Laws. Each Party is responsible for complying with applicable laws and regulations relating to this Agreement and any purchase made under this Agreement.

10. Termination. This Agreement may be terminated prior to the expiration of the Term hereof as follows:

- By either Party, with or without cause, upon thirty (30) days' prior written notice;
- By mutual written agreement of the Parties; or
- By either Party immediately if the other Party commits a material breach of any of the terms of this Agreement and no remedial action can be agreed upon by the Parties.

Termination of this Agreement by a Party shall not terminate an existing purchase order or individual contract between HCDE and LGE or between LGE and an HCDE cooperative purchasing program vendor. In the event of termination of this Agreement or any purchase order or individual contract, LGE shall be responsible for compensating HCDE for programs and services provided by HCDE up to the effective date of termination.

11. Assignment. Neither this Agreement nor any duties or obligations entered in subsequent contracts because of this agreement shall be assignable by either party without the prior written acknowledgment and authorization of both parties.

12. Conflict of Interest. During the Term of HCDE's service to LGE, LGE, its personnel and agents, shall not, directly or indirectly, whether for LGE's own account or with any other person or entity whatsoever, employ, solicit or endeavor to entice away any person who is employed by HCDE.

13. Contract Amendment. This Agreement may be amended only by the mutual agreement of all Parties, in writing, to be attached to and incorporated into this Agreement.

14. Notice. Any notice provided under the terms of this Agreement by either party to the other shall be in writing and shall be sent by **certified mail, return receipt requested**. Notice to shall be sufficient if made or addressed as follows:

Harris County Department of Education  
Attn: James Colbert, Jr.  
County School Superintendent  
6300 Irvington Blvd.  
Houston, Texas 77022  
713-694-6300

Polk County \_\_\_\_\_ (“LGE”)  
Attn: Sydney Murphy  
Title: County Judge  
Address: 101 W. Church St  
City, State, Zip: Livingston, TX 77351  
Phone: 936-327-6813  
Email: county.judge@co.polk.tx.us

15. Relation of Parties. It is the intention of the parties that LGE is independent of HCDE and not an employee, agent, joint venturer, or partner of HCDE and nothing in this Agreement shall be interpreted or construed as creating or establishing the relationship of employer and employee, agent, joint venturer or partner, between HCDE and LGE or HCDE and any of LGE's representatives.

16. Non-Exclusivity of Services. Nothing in this Agreement may be construed to imply that HCDE has exclusive right to provide LGE with programs or services. During the Term of this Agreement, LGE reserves the right to use all available resources to procure other programs and services as needed and, in doing so, will not violate any rights of HCDE.



17. **Disclaimer.** HCDE DOES NOT WARRANT THAT THE OPERATION OR USE OF HCDE PROGRAMS AND/OR SERVICES WILL BE UNINTERRUPTED OR ERROR FREE. HCDE HEREBY DISCLAIMS ANY AND ALL WARRANTIES, EXPRESS OR IMPLIED, IN REGARD TO ANY INFORMATION, PRODUCT, PROGRAM, OR SERVICE FURNISHED UNDER THIS AGREEMENT, INCLUDING, WITHOUT LIMITATION, ANY AND ALL IMPLIED WARRANTIES OF MERCHANTABILITY OR FITNESS FOR A PARTICULAR PURPOSE.
18. **Limitation of Liability.** Without waiver of the Disclaimer in Article 17 of this Agreement, the Parties agree that:
  - Neither Party waives any immunity afforded to it under applicable law; and
  - Neither Party shall be liable to the other Party for special, incidental, or exemplary damages with regard to any lawsuit or formal adjudication arising out of or relating to this Agreement.
19. **Severability.** In the event that any one or more of the provisions contained in this Agreement shall for any reason be held to be invalid, illegal, or unenforceable in any respect, such invalidity, illegality, or unenforceability shall not affect any other provisions, and the Agreement shall be construed as if such invalid, illegality, or unenforceable provision had never been contained in it.
20. **Governing Law and Venue.** This Agreement shall be governed by and construed in accordance with the laws of the State of Texas, without regard to its conflicts of laws provisions. The mandatory and exclusive venue for the adjudication or resolution of any dispute arising out of this Agreement shall be in Houston, Harris County, Texas.
21. **No Waiver.** Nothing in this Agreement shall be deemed to waive, modify, or amend any legal defense available at law or equity to a Party, including the defense(s) of immunity. No failure on the part of either Party at any time to require the performance by the other Party of any term hereof shall be taken or held to be a waiver of such term or in any way affect such Party's right to enforce such term, and no waiver on the part of either Party of any term hereof shall be taken or held to be a waiver of any other term hereof or the breach thereof. No waiver, alteration, or modification of any of the provisions of this Agreement shall be binding unless in writing and signed by duly authorized representatives of the Parties hereto.
22. **Benefit for Signatory Parties Only.** Neither this Agreement, nor any term or provisions hereof, not any inclusion by reference, shall be construed as being for the benefit of any party not in signatory hereto.
23. **Authorization.** Each party acknowledges that the governing body of each Party to the Agreement has authorized and approved this Agreement.
24. **Counterparts.** This Agreement may be executed in any number of counterparts, each of which shall be deemed an original constituting one and the same instrument.

In witness whereof, HCDE and LGE have executed this Agreement to be effective on the date specified in Article 1. Term above:

**Polk County**

Name of Local Governmental Entity

Harris County Department of Education

  
Authorized Signature

**Sydney Murphy**

James Colbert, Jr.

Printed Name

**Polk County Judge**

County School Superintendent

Title

**April 12, 2021**

Date

Date

Type of Local Governmental Entity (*select one*):

- School District       Charter School
- County                       City/Municipality
- University                   College
- State Entity
- Governmental entity/other: \_\_\_\_\_

**Participation Agreement**  
**between Harris County Department of Education**  
**& POLK COUNTY**

This Participation Agreement (“Agreement”) is made and entered into by and between Harris County Department of Education (“HCDE”), located in Houston, Texas, and Polk County, a non-profit corporation (“Non-Profit”), located in Livingston (*city*), Texas (*state*), for the purpose of permitting Non-Profit to participate in any or all of the programs and services that HCDE offers, including, without limitation, HCDE’s cooperative purchasing program, Choice Partners. The undersigned may be referred to in this Agreement individually as a “Party” and collectively as the “Parties.”

**Preamble**

HCDE is a local governmental entity established to promote education in Harris County, Texas and is duly authorized to provide programs and services in the State of Texas. Non-Profit certifies, represents, and warrants that it is a non-profit, tax-exempt entity. Both HCDE and Non-Profit desire to set forth, in writing, the terms and conditions of their agreement.

**General Terms and Conditions**

In consideration of the mutual covenants and conditions contained in this Agreement and other good and valuable consideration, the receipt and sufficiency of which are hereby acknowledged, the parties, intending to be legally bound, agree as follows:

1. **Term.** The term of this Agreement shall commence on the date of the first signature of this Agreement (“Effective Date”) and shall automatically renew annually, unless either Party gives thirty (30) days prior written notice of non-renewal.
2. **Agreement.** The terms of this Agreement shall apply and will be considered a part of any addendum, purchase order, or contract for programs and services delivered by HCDE. This Agreement and the attached and incorporated addenda, purchase orders, or exhibits, if any, contain the entire agreement of the parties, and there are no representations, agreements, arrangements, or undertakings, oral or written, between the Parties to this Agreement other than those set forth in this Agreement and duly executed in writing.
3. **Purpose and Scope of Work.**
  - A. **HCDE agrees to:**
    - Provide Non-Profit with descriptive offerings of each of the programs and services that HCDE provides.
    - Provide programs and services upon Non-Profit’s submission of independent contracts or purchase orders to HCDE and HCDE’s acceptance thereof. HCDE’s obligations to provide programs and services is contingent on HCDE acquiring and maintaining sufficient staffing through reasonable efforts to satisfy HCDE’s obligations under this Agreement and all similar obligations under its contracts with other local governmental entities.
    - Conduct, at a minimum, an annual audit or survey, as appropriate, for each of the programs and services that HCDE delivers.
  - B. **Non-Profit agrees to:**

- Participate in any or all of the programs and services that HCDE offers, in Non-Profit's sole discretion.
  - Submit purchase order(s) or independent contract(s) for each of the HCDE programs and/or services that Non-Profit desires to purchase and/or collaborate.
  - Agree to follow the terms and conditions of each independent contract or purchase order.
  - Designate a person to act as Non-Profit's representative to each respective HCDE program and/or service delivered.
4. As is. HCDE makes this Agreement available to HCDE participating entities "as is" and is under no obligation to revise the terms, conditions, scope, prices, and/or any requirements of the Agreement for the benefit of Non-Profit.
5. Master Contract. This Agreement can be utilized as a Master Contract. The general terms and conditions in this Agreement will serve to outline the working relationship between HCDE and Non-Profit.

Non-Profit agrees to adhere to the specific terms and conditions set forth for the HCDE programs and/or services as contracted by Non-Profit. In the case of a conflict between this Agreement and any addendum, purchase order, or individual contract for a specific HCDE program or service, the provisions of the addendum, purchase order, or individual contract will govern.

6. Payments. The Parties agree that all payments made under this Agreement will be in an amount that fairly compensates the performing Party for the services or functions performed under this Agreement. The Parties further agree that each Party paying for the performance of governmental functions or services pursuant to this Agreement must make those payments from current revenues available to the paying Party.
7. Invoices. HCDE will invoice Non-Profit for the HCDE programs and services that Non-Profit purchases from HCDE. Non-Profit agrees to remit payment to HCDE within thirty (30) days after the later of the following: (1) the date Non-Profit receives the goods; (2) the date the performance of the service is completed; or (3) the date Non-Profit receives an invoice for the goods or service. If Non-Profit makes a payment to HCDE with a credit card, Non-Profit agrees to pay to HCDE a surcharge fee consisting of any applicable credit card fees and/or costs incurred by HCDE, including, without limitation, the processing fee(s) charged to HCDE by the credit card company(ies).
8. Participation in HCDE's Cooperative Purchasing Program. If Non-Profit elects to participate in HCDE's cooperative purchasing program, Choice Partners, Non-Profit shall be permitted to purchase goods and services using the contracts competitively procured by HCDE. HCDE does not assess a fee to Non-Profit for participation in Choice Partners. Non-Profit shall make payments directly to vendors. Non-Profit shall be responsible for ordering, inspecting, and accepting the goods and services purchased through Choice Partners. Non-Profit shall further be responsible for the vendors' compliance with provisions relating to the specific quality of goods and services delivered and terms of delivered, as set forth between Non-Profit and the vendor. HCDE is not responsible or liable for the performance of any vendor used by Non-Profit as a result of this Agreement or Non-Profit's participation in Choice Partners.

9. Compliance with Laws. Each Party is responsible for complying with applicable laws and regulations relating to this Agreement and any purchase made under this Agreement.
10. Termination. This Agreement may be terminated prior to the expiration of the Term hereof as follows:
  - By either Party, with or without cause, upon thirty (30) days' prior written notice;
  - By mutual written agreement of the Parties; or
  - By either Party immediately if the other Party commits a material breach of any of the terms of this Agreement and no remedial action can be agreed upon by the Parties.

Termination of this Agreement by a Party shall not terminate an existing purchase order or individual contract between HCDE and Non-Profit or between Non-Profit and an HCDE cooperative purchasing program vendor. In the event of termination of this Agreement or any purchase order or individual contract, Non-Profit shall be responsible for compensating HCDE for programs and services provided by HCDE up to the effective date of termination.

11. Assignment. Neither this Agreement nor any duties or obligations entered in subsequent contracts because of this agreement shall be assignable by either party without the prior written acknowledgment and authorization of both parties.
12. Conflict of Interest. During the Term of HCDE's service to Non-Profit, Non-Profit, its personnel and agents, shall not, directly or indirectly, whether for Non-Profit's own account or with any other person or entity whatsoever, employ, solicit or endeavor to entice away any person who is employed by HCDE.
13. Certificate of Interested Parties. HCDE is required to comply with House Bill 1295, which amended the Texas Government Code by adding Section 2252.908, Disclosure of Interested Parties. Section 2252.908 prohibits HCDE from entering into a contract with a business entity unless the business entity submits a Disclosure of Interested Parties (Form 1295) to HCDE at the time business entity submits the signed contract. Non-Profit agrees to complete the Certificate of Interested Parties electronically with the Texas Ethics Commission and submit the original signed, notarized certificate to HCDE with submission of this signed Agreement.
14. Contract Amendment. This Agreement may be amended only by the mutual agreement of all Parties, in writing, to be attached to and incorporated into this Agreement.
15. Notice. Any notice provided under the terms of this Agreement by either party to the other shall be in writing and shall be sent by **certified mail, return receipt requested.** Notice to shall be sufficient if made or addressed as follows:

Harris County Department of Education  
 Attn: James Colbert, Jr.  
 County School Superintendent  
 6300 Irvington Blvd.  
 Houston, Texas 77022  
 713-694-6300

Polk County \_\_\_\_\_ Non-Profit")  
 Attn: Sydney Murphy  
 Title: County Judge  
 Address: 101 W. Church St.  
 City, State, Zip: Livingston, Texas 77351  
 Phone: 936-327-6813  
 Email: county.judge@co.polk.tx.us

16. Relation of Parties. It is the intention of the parties that Non-Profit is independent of HCDE and not an employee, agent, joint venturer, or partner of HCDE and nothing in this Agreement shall be interpreted or construed as creating or establishing the relationship of employer and employee, agent, joint venturer or partner, between HCDE and Non-Profit or HCDE and any of Non-Profit's representatives.
17. Non-Exclusivity of Services. Nothing in this Agreement may be construed to imply that HCDE has exclusive right to provide Non-Profit with programs or services. During the Term of this Agreement, Non-Profit reserves the right to use all available resources to procure other programs and services as needed and, in doing so, will not violate any rights of HCDE.
18. Disclaimer. HCDE DOES NOT WARRANT THAT THE OPERATION OR USE OF HCDE PROGRAMS AND/OR SERVICES WILL BE UNINTERRUPTED OR ERROR FREE. HCDE HEREBY DISCLAIMS ANY AND ALL WARRANTIES, EXPRESS OR IMPLIED, IN REGARD TO ANY INFORMATION, PRODUCT, PROGRAM, OR SERVICE FURNISHED UNDER THIS AGREEMENT, INCLUDING, WITHOUT LIMITATION, ANY AND ALL IMPLIED WARRANTIES OF MERCHANTABILITY OR FITNESS FOR A PARTICULAR PURPOSE.
19. Limitation of Liability. Without waiver of the Disclaimer in Article 17 of this Agreement, the Parties agree that:
  - Neither Party waives any immunity afforded to it under applicable law; and
  - Neither Party shall be liable to the other Party for special, incidental, or exemplary damages with regard to any lawsuit or formal adjudication arising out of or relating to this Agreement.
20. Severability. In the event that any one or more of the provisions contained in this Agreement shall for any reason be held to be invalid, illegal, or unenforceable in any respect, such invalidity, illegality, or unenforceability shall not affect any other provisions, and the Agreement shall be construed as if such invalid, illegality, or unenforceable provision had never been contained in it.
21. Governing Law and Venue. This Agreement shall be governed by and construed in accordance with the laws of the State of Texas, without regard to its conflicts of laws provisions. The mandatory and exclusive venue for the adjudication or resolution of any dispute arising out of this Agreement shall be in Houston, Harris County, Texas.
22. No Waiver. Nothing in this Agreement shall be deemed to waive, modify, or amend any legal defense available at law or equity to a Party, including the defense(s) of immunity. No failure on the part of either Party at any time to require the performance by the other Party of any term hereof shall be taken or held to be a waiver of such term or in any way affect such Party's right to enforce such term, and no waiver on the part of either Party of any term hereof shall be taken or held to be a waiver of any other term hereof or the breach thereof. No waiver, alteration, or modification of any of the provisions of this Agreement shall be binding unless in writing and signed by duly authorized representatives of the Parties hereto.

- 23. Benefit for Signatory Parties Only. Neither this Agreement, nor any term or provisions hereof, not any inclusion by reference, shall be construed as being for the benefit of any party not in signatory hereto.
- 24. Authorization. Each party acknowledges that the governing body of each Party to the Agreement has authorized and approved this Agreement.
- 25. Counterparts. This Agreement may be executed in any number of counterparts, each of which shall be deemed an original constituting one and the same instrument.

In witness whereof, HCDE and Non-Profit have executed this Agreement to be effective on the date specified in Article 1. Term above:

Polk County  
Name of Non-Profit Corporation

Harris County Department of Education

  
Authorized Signature

\_\_\_\_\_

Sydney  
Printed Name

James Colbert, Jr.

Polk County Judge  
Title

County School Superintendent

April 12, 2021  
Date

\_\_\_\_\_ Date



Choice Partners national purchasing cooperative offers quality, legal procurement and contract solutions to meet government purchasing requirements. We also meet all of the EDGAR/Uniform Guidance/2 CFR 200 requirements!

Member Login



877.696.2122

[Home](#)

[About Us](#)

[Members](#)

[Vendors](#)

[Services](#)

[Bidders/RFPs](#)

[About Us](#)

All-in-One Cooperative

# All-in-One Cooperative

HCDE: Choice Partners, 85 million lunches



Since the 1960's, Harris County

Department of Education (HCDE) has been providing cooperative purchasing services. Rebranded in 2012 as Choice Partners, the cooperative traces its history as one of the first, if not the first, government cooperative in Texas.

As a division of a government agency and former school district, Choice Partners contracts are awarded by the HCDE governing board of



trustees. Interlocal government-to-government agreements are between HCDE and the government entity wishing to use the Choice Partners cooperative contract. Because Choice Partners is a division of Harris County Department of Education, it does not need an additional affiliation to make its operation legal. Some cooperatives are not based in a government entity, so must affiliate with one so they will have a government “lead agency.” Using that language, HCDE is the lead agency for Choice Partners.

HCDE merged their three procurement cooperatives into Choice Partners in 2012 to make purchasing even easier for their cooperative members. To optimize processes, Choice Facility Partners, HCDE Purchasing Cooperative and the Gulf Coast Food Co-op, were combined into Choice Partners national cooperative. Combining all contract procurement services for education, facilities, food, supplies and services, and technology makes it easy for client members to access the contracts they need.

Choice Partners national cooperative provides quality services, legal procurement and contract solutions for governmental entities, including school districts, private and charter schools, colleges and universities, municipalities, counties and nonprofits.

To join as a Member, [sign up here](#) today!



Choice Partners national purchasing cooperative offers quality, legal procurement and contract solutions to meet government purchasing requirements. We also meet all of the EDGAR/Uniform Guidance/2 CFR 200 requirements!

Search...  
Member Login



877.696.2122

[Home](#)

[About Us](#)

[Members](#)

[Vendors](#)

[Services](#)

[Bidders/RFPs](#)

[About Us](#)

[About Choice Partners](#)

# Choice Partners Cooperative

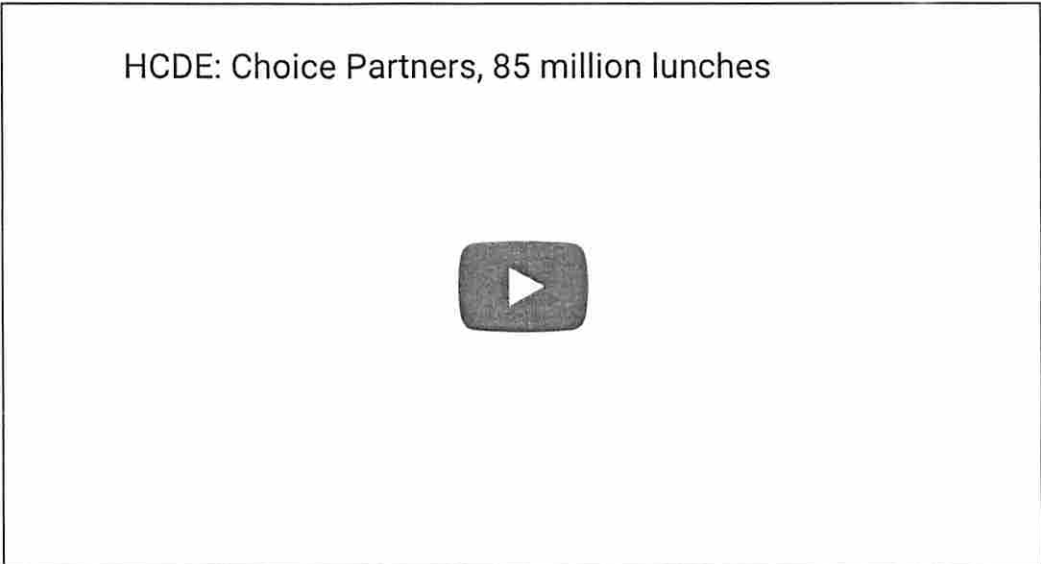

Choice Partners national purchasing cooperative offers procurement and contract solutions to meet government purchasing requirements. Staff at Choice Partners complete the legal, competitively bid government procurement process so YOU can act immediately to access the contract YOU need, saving time and money on the bidding process and purchase. Choice Partners national cooperative includes:

- Facility contracts to meet needs for repair, remediation, renovation and remodeling.

- Supplies, including a unique school supply catalog.
- Service contracts
- Food contracts for bread, dairy, grocery, produce and cleaning/ware washing products.
- Technology products, cloud services, software, consulting and resources for today's electronic demands.

Become a member!

To access the Choice Partners shared services solutions, please register. If you represent a governmental entity in Texas, [sign-up](#) to download the interlocal contract that you need for your governing board's approval. Once it is approved, send it to Choice Partners for our HCDE governing board approval.

If you are in a state other than Texas, simply [sign-up](#), then follow your state's procurement laws.

Contracts may only be used by governmental entities, such as school districts, private and charter schools, colleges and universities, municipalities, counties, other governmental agencies and nonprofits. [Become a member](#) today and enjoy the procurement services and solutions we provide.

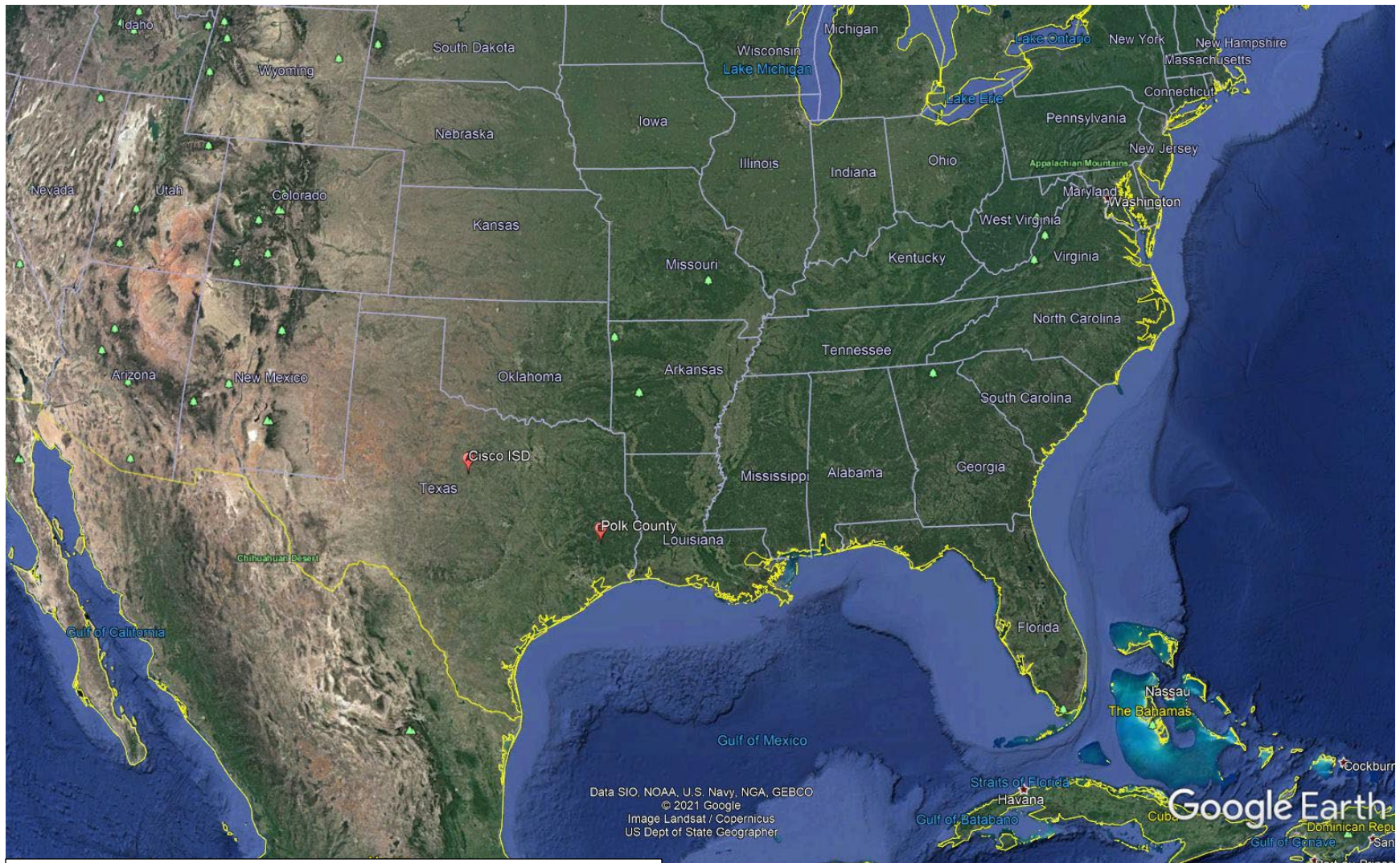

**July 21, 2021**

**HCDE Board Agenda Interlocal Map:**

**A: Cisco ISD**

**B. Polk County, Texas**

**Regular Board Meeting**

**8.F.1.**

**Meeting Date:** July 21, 2021  
**Title:** Contract Renewal for RFP No. 17/046MR Playground Equipment and Supplies  
**Submitted For:** Kendra Jackson, Purchasing  
**Submitted By:** Inga Ash  
**Recommended Action:** Approve  
**HCDE Goal(s):** 2. Deliver value responsibly  
 4. Provide cost savings by leveraging tax dollars

**Additional Resource Personnel:** Venetia Peacock, Dr. Jesus Amezcua, Kendra Jackson, Inga Ash  
**Facilities/Technology Approval Needed?:** None

**Information**

**Posted Agenda Item:**

**Approval of Contract Renewal option for job no. 17/046MR for Playground Equipment and Supplies with the following vendor:**Kaplan Early Learning Company for the period of 08/16/2021 through 08/15/2022.

**Subject:**

Head Start, Purchasing, Playground Equipment

**Rationale:**

HCDE contract no. 17/046MR was awarded for one (2) years from 08/16/2017 through 08/15/2019. The contract has the option for three (3) annual renewals. HCDE recommends exercising the last option for renewal period of 08/16/2021 through 08/15/2022 for the vendor listed above in Post Agenda Item. This contract Contract is in accordance with Texas Education Code 44.031.

**Fiscal Impact**

**Attachments**

Execution of Offer

**Form Review**

**Inbox**  
 Purchasing (Originator)  
 Assistant Superintendent - Business  
 Form Started By: Inga Ash  
 Final Approval Date: 07/06/2021

**Reviewed By**  
 Kendra Jackson  
 Venetia Baldwin

**Date**  
 06/30/2021 01:34 PM  
 07/06/2021 09:58 AM  
 Started On: 06/30/2021 12:27 PM

**HARRIS COUNTY DEPARTMENT OF EDUCATION  
EXECUTION OF OFFER – CONTRACT RENEWAL**

The undersigned company representative has carefully examined all instructions, requirements, specifications, terms, and conditions of the original proposal and this contract renewal and certifies:

- 1) It has the necessary experience, knowledge, abilities, skills, and resources to satisfactorily perform the requirements, specifications, terms and conditions of the original RFP.
- 2) All statements, information, and representations prepared and submitted in response to this contract renewal request are current, complete, true, and accurate.
- 3) It is not currently barred or suspended from doing business with the Federal government, any of the members represented, or any of their respective agencies.
- 4) It shall be bound by all statements, representations, warranties, and guarantees made in the original proposal and the updated terms and conditions.
- 5) That all of the requirements of this contract renewal have been read and understood. In addition, compliance with all requirements, terms and conditions will be assumed by HCDE if not otherwise noted.
- 6) The individual signing below has authority to enter into this contract renewal on behalf of Vendor.
- 7) Vendor acknowledges that the Agreement may be canceled if any conflict of interest or appearance of a conflict of interest is discovered by HCDE.
- 8) This contract is subject to purchase orders duly authorized and executed by HCDE.

<b>CORPORATE NAME:</b>	Kaplan Early Learning Company		
<b>AUTHORIZED SIGNATURE:</b>			
<b>PRINT NAME:</b>	Elizabeth Patterson		
<b>TITLE:</b>	Associate Director of Bids/Contracts		
<b>DATE:</b>	6-7-21		
<b>ADDRESS:</b>	1310 Lewisville-Clemmons Rd		
<b>CITY, STATE, ZIP CODE:</b>	Lewisville, NC 27023		
<b>PHONE:</b>	800-334-2014	<b>FAX:</b>	336-712-2243
<b>EMAIL ADDRESS:</b>	bids@kaplanco.com		

-----  
**This section to be completed by HCDE**

Contract Number: \_\_\_\_\_ Original term of contract: \_\_\_\_\_ to \_\_\_\_\_

Contract Renewal Term: \_\_\_\_\_ to \_\_\_\_\_ Number of Renewal Options Left \_\_\_\_\_

This contract renewal shall be for the period of one (1) year if agreed to by HCDE and awarded vendor.

Approved by Harris County Department of Education:

\_\_\_\_\_  
Jesus J. Amezcua, Ph.D., CPA, RTSBA  
Assistant Superintendent for Business Services

\_\_\_\_\_  
Approval Date

**Regular Board Meeting**

**8.F.2.**

**Meeting Date:** July 21, 2021

**Title:** Contract renewal for RFP No. 18/049YR for CASE for Kids After School and Summer Direct Service Providers

**Submitted For:** Kendra Jackson, Purchasing

**Submitted By:** Inga Ash

**Recommended Action:** Approve

**HCDE Goal(s):**  
1. Impact education/respond to evolving needs  
5. Recruit high-quality professionals

**Additional Resource Personnel:** Dr. Lisa Caruthers, Dr. Jesus Amezcua, Kendra Jackson, Inga Ash

**Facilities/Technology Approval Needed?:**

**Information**

**Posted Agenda Item:**

**Approval of Contract Renewal options for job no. 18/049YR for CASE for Kids After School and Summer Direct Service Providers with the following vendors:**Alliance Financial Ministries, Inc., American Robotics Academy (Animation Station Inc), Color of Life (Color of Life Community Resource & Activity Center), JumpBunch (CSCRM, Inc.), Mad Science of Houston (Little Scientists Inc.), and Young Picassos Houston for the period of 08/15/2021 through 08/14/2022.

**Subject:**

After School; Summer; Consultants; CASE

**Rationale:**

HCDE contract no 18/049YR was awarded for one (1) year from 08/15/2018 through 08/14/2019. The contract has the option for four (4) annual renewals. HCDE recommends exercising the third (3rd) option for renewal period 08/15/2021 through 08/14/2022 for the vendor listed above in Posted Agenda Item.

Contract is in accordance with Texas Education Code 44.031.

**Fiscal Impact**

**Attachments**

Execution of Offers

**Form Review**

**Inbox**

Purchasing (Originator)  
Assistant Superintendent - Business  
Form Started By: Inga Ash  
Final Approval Date: 07/09/2021

**Reviewed By**

Kendra Jackson  
Jesus Amezcua

**Date**

07/06/2021 01:07 PM  
07/09/2021 03:54 PM  
Started On: 06/30/2021 02:34 PM

**HARRIS COUNTY DEPARTMENT OF EDUCATION  
EXECUTION OF OFFER – CONTRACT RENEWAL**

The undersigned company representative has carefully examined all instructions, requirements, specifications, terms, and conditions of the original proposal and this contract renewal and certifies:

- 1) It has the necessary experience, knowledge, abilities, skills, and resources to satisfactorily perform the requirements, specifications, terms and conditions of the original RFP.
- 2) All statements, information, and representations prepared and submitted in response to this contract renewal request are current, complete, true, and accurate.
- 3) It is not currently barred or suspended from doing business with the Federal government, any of the members represented, or any of their respective agencies.
- 4) It shall be bound by all statements, representations, warranties, and guarantees made in the original proposal and the updated terms and conditions.
- 5) That all of the requirements of this contract renewal have been read and understood. In addition, compliance with all requirements, terms and conditions will be assumed by HCDE if not otherwise noted.
- 6) The individual signing below has authority to enter into this contract renewal on behalf of Vendor.
- 7) Vendor acknowledges that the Agreement may be canceled if any conflict of interest or appearance of a conflict of interest is discovered by HCDE.
- 8) This contract is subject to purchase orders duly authorized and executed by HCDE.

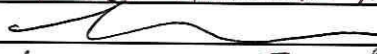
<b>CORPORATE NAME:</b>	Alliance Financial Ministries, Inc.		
<b>AUTHORIZED SIGNATURE:</b>			
<b>PRINT NAME:</b>	Lennie Mathews		
<b>TITLE:</b>	Director		
<b>DATE:</b>	6/14/2021		
<b>ADDRESS:</b>	2600 South Loop W Ste 271		
<b>CITY, STATE, ZIP CODE:</b>	Houston, TX 77054		
<b>PHONE:</b>	281 386-7951	<b>FAX:</b>	
<b>EMAIL ADDRESS:</b>	lennie@alliancefinancialministries.org		

**This section to be completed by HCDE**

Contract Number: \_\_\_\_\_ Original term of contract: \_\_\_\_\_ to \_\_\_\_\_

Contract Renewal Term: \_\_\_\_\_ to \_\_\_\_\_ Number of Renewal Options Left \_\_\_\_\_

This contract renewal shall be for the period of one (1) year if agreed to by HCDE and awarded vendor.

Approved by Harris County Department of Education:

\_\_\_\_\_  
Jesus J. Amezcua, Ph.D., CPA, RTSBA  
Assistant Superintendent for Business Services

\_\_\_\_\_  
Approval Date



**HARRIS COUNTY DEPARTMENT OF EDUCATION  
EXECUTION OF OFFER – CONTRACT RENEWAL**

The undersigned company representative has carefully examined all instructions, requirements, specifications, terms, and conditions of the original proposal and this contract renewal and certifies:

- 1) It has the necessary experience, knowledge, abilities, skills, and resources to satisfactorily perform the requirements, specifications, terms and conditions of the original RFP.
- 2) All statements, information, and representations prepared and submitted in response to this contract renewal request are current, complete, true, and accurate.
- 3) It is not currently barred or suspended from doing business with the Federal government, any of the members represented, or any of their respective agencies.
- 4) It shall be bound by all statements, representations, warranties, and guarantees made in the original proposal and the updated terms and conditions.
- 5) That all of the requirements of this contract renewal have been read and understood. In addition, compliance with all requirements, terms and conditions will be assumed by HCDE if not otherwise noted.
- 6) The individual signing below has authority to enter into this contract renewal on behalf of Vendor.
- 7) Vendor acknowledges that the Agreement may be canceled if any conflict of interest or appearance of a conflict of interest is discovered by HCDE.
- 8) This contract is subject to purchase orders duly authorized and executed by HCDE.

<b>CORPORATE NAME:</b>	Animation Station, INC dba AMERICAN		
<b>AUTHORIZED SIGNATURE:</b>	<i>Daphney Kirby</i>		
<b>PRINT NAME:</b>	DAPHNEY KIRBY		
<b>TITLE:</b>	Director		
<b>DATE:</b>	6/20/21		
<b>ADDRESS:</b>	35750 SIENZEL RD		
<b>CITY, STATE, ZIP CODE:</b>	PARKER, TX 77423		
<b>PHONE:</b>	281-642-5903	<b>FAX:</b>	
<b>EMAIL ADDRESS:</b>	DAPHNEY.KIRBY@ROBOTICSACADEMY.COM		

**This section to be completed by HCDE**

Contract Number: \_\_\_\_\_ Original term of contract: \_\_\_\_\_ to \_\_\_\_\_

Contract Renewal Term: \_\_\_\_\_ to \_\_\_\_\_ Number of Renewal Options Left \_\_\_\_\_

This contract renewal shall be for the period of one (1) year if agreed to by HCDE and awarded vendor.

Approved by Harris County Department of Education:

\_\_\_\_\_  
Jesus J. Amezcua, Ph.D., CPA, RTSBA  
Assistant Superintendent for Business Services

\_\_\_\_\_  
Approval Date

**HARRIS COUNTY DEPARTMENT OF EDUCATION  
EXECUTION OF OFFER – CONTRACT RENEWAL**

The undersigned company representative has carefully examined all instructions, requirements, specifications, terms, and conditions of the original proposal and this contract renewal and certifies:

- 1) It has the necessary experience, knowledge, abilities, skills, and resources to satisfactorily perform the requirements, specifications, terms and conditions of the original RFP.
- 2) All statements, information, and representations prepared and submitted in response to this contract renewal request are current, complete, true, and accurate.
- 3) It is not currently barred or suspended from doing business with the Federal government, any of the members represented, or any of their respective agencies.
- 4) It shall be bound by all statements, representations, warranties, and guarantees made in the original proposal and the updated terms and conditions.
- 5) That all of the requirements of this contract renewal have been read and understood. In addition, compliance with all requirements, terms and conditions will be assumed by HCDE if not otherwise noted.
- 6) The individual signing below has authority to enter into this contract renewal on behalf of Vendor.
- 7) Vendor acknowledges that the Agreement may be canceled if any conflict of interest or appearance of a conflict of interest is discovered by HCDE.
- 8) This contract is subject to purchase orders duly authorized and executed by HCDE.

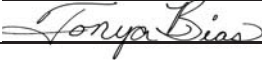
<b>CORPORATE NAME:</b>	Color of Life Community Resource & Activity Center		
<b>AUTHORIZED SIGNATURE:</b>			
<b>PRINT NAME:</b>	Tonya Bias		
<b>TITLE:</b>	Founder/CEO		
<b>DATE:</b>	6/14/21		
<b>ADDRESS:</b>	13105 Northwest Freeway, Suite 764		
<b>CITY, STATE, ZIP CODE:</b>	Houston, TX 77040		
<b>PHONE:</b>	832-409-0079	<b>FAX:</b>	
<b>EMAIL ADDRESS:</b>	tonya@coloroflifeyouth.org		

-----  
**This section to be completed by HCDE**

Contract Number: \_\_\_\_\_ Original term of contract: \_\_\_\_\_ to \_\_\_\_\_

Contract Renewal Term: \_\_\_\_\_ to \_\_\_\_\_ Number of Renewal Options Left \_\_\_\_\_

This contract renewal shall be for the period of one (1) year if agreed to by HCDE and awarded vendor.

Approved by Harris County Department of Education:

\_\_\_\_\_  
Jesus J. Amezcua, Ph.D., CPA, RTSBA  
Assistant Superintendent for Business Services

\_\_\_\_\_  
Approval Date

**HARRIS COUNTY DEPARTMENT OF EDUCATION  
EXECUTION OF OFFER – CONTRACT RENEWAL**

The undersigned company representative has carefully examined all instructions, requirements, specifications, terms, and conditions of the original proposal and this contract renewal and certifies:

- 1) It has the necessary experience, knowledge, abilities, skills, and resources to satisfactorily perform the requirements, specifications, terms and conditions of the original RFP.
- 2) All statements, information, and representations prepared and submitted in response to this contract renewal request are current, complete, true, and accurate.
- 3) It is not currently barred or suspended from doing business with the Federal government, any of the members represented, or any of their respective agencies.
- 4) It shall be bound by all statements, representations, warranties, and guarantees made in the original proposal and the updated terms and conditions.
- 5) That all of the requirements of this contract renewal have been read and understood. In addition, compliance with all requirements, terms and conditions will be assumed by HCDE if not otherwise noted.
- 6) The individual signing below has authority to enter into this contract renewal on behalf of Vendor.
- 7) Vendor acknowledges that the Agreement may be canceled if any conflict of interest or appearance of a conflict of interest is discovered by HCDE.
- 8) This contract is subject to purchase orders duly authorized and executed by HCDE.

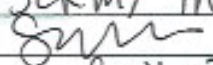
CORPORATE NAME:	CSCRM, INC. dba: JumpBunch		
AUTHORIZED SIGNATURE:			
PRINT NAME:	Cindy Taylor		
TITLE:	Owner		
DATE:	6/14/2021		
ADDRESS:	4436 HDH ST. #		
CITY, STATE, ZIP CODE:	Belvaire TX 77401		
PHONE:	713-894-7477	FAX:	N/A
EMAIL ADDRESS:	COACHcindy1@yahoo.com		

**This section to be completed by HCDE**

Contract Number: \_\_\_\_\_ Original term of contract: \_\_\_\_\_ to \_\_\_\_\_

Contract Renewal Term: \_\_\_\_\_ to \_\_\_\_\_ Number of Renewal Options Left \_\_\_\_\_

This contract renewal shall be for the period of one (1) year if agreed to by HCDE and awarded vendor.

Approved by Harris County Department of Education:

\_\_\_\_\_  
Jesus J. Amezcua, Ph.D., CPA, RTSBA  
Assistant Superintendent for Business Services

\_\_\_\_\_  
Approval Date

**HARRIS COUNTY DEPARTMENT OF EDUCATION  
EXECUTION OF OFFER – CONTRACT RENEWAL**

The undersigned company representative has carefully examined all instructions, requirements, specifications, terms, and conditions of the original proposal and this contract renewal and certifies:

- 1) It has the necessary experience, knowledge, abilities, skills, and resources to satisfactorily perform the requirements, specifications, terms and conditions of the original RFP.
- 2) All statements, information, and representations prepared and submitted in response to this contract renewal request are current, complete, true, and accurate.
- 3) It is not currently barred or suspended from doing business with the Federal government, any of the members represented, or any of their respective agencies.
- 4) It shall be bound by all statements, representations, warranties, and guarantees made in the original proposal and the updated terms and conditions.
- 5) That all of the requirements of this contract renewal have been read and understood. In addition, compliance with all requirements, terms and conditions will be assumed by HCDE if not otherwise noted.
- 6) The individual signing below has authority to enter into this contract renewal on behalf of Vendor.
- 7) Vendor acknowledges that the Agreement may be canceled if any conflict of interest or appearance of a conflict of interest is discovered by HCDE.
- 8) This contract is subject to purchase orders duly authorized and executed by HCDE.

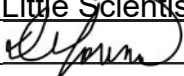
<b>CORPORATE NAME:</b>	Little Scientist Inc. DBA Mad Science of Houston		
<b>AUTHORIZED SIGNATURE:</b>			
<b>PRINT NAME:</b>	Diana Moreno		
<b>TITLE:</b>	Operations Manager		
<b>DATE:</b>	5/17/2021		
<b>ADDRESS:</b>	6300 Westpark Ste. 500		
<b>CITY, STATE, ZIP CODE:</b>	Houston, Texas, 77057		
<b>PHONE:</b>	713-663-7623	<b>FAX:</b>	713-663-7664
<b>EMAIL ADDRESS:</b>	Operations@madscienceofhouston.com		

-----  
**This section to be completed by HCDE**

Contract Number: \_\_\_\_\_ Original term of contract: \_\_\_\_\_ to \_\_\_\_\_

Contract Renewal Term: \_\_\_\_\_ to \_\_\_\_\_ Number of Renewal Options Left \_\_\_\_\_

This contract renewal shall be for the period of one (1) year if agreed to by HCDE and awarded vendor.

Approved by Harris County Department of Education:

\_\_\_\_\_  
Jesus J. Amezcua, Ph.D., CPA, RTSBA  
Assistant Superintendent for Business Services

\_\_\_\_\_  
Approval Date

**HARRIS COUNTY DEPARTMENT OF EDUCATION  
EXECUTION OF OFFER – CONTRACT RENEWAL**

The undersigned company representative has carefully examined all instructions, requirements, specifications, terms, and conditions of the original proposal and this contract renewal and certifies:

- 1) It has the necessary experience, knowledge, abilities, skills, and resources to satisfactorily perform the requirements, specifications, terms and conditions of the original RFP.
- 2) All statements, information, and representations prepared and submitted in response to this contract renewal request are current, complete, true, and accurate.
- 3) It is not currently barred or suspended from doing business with the Federal government, any of the members represented, or any of their respective agencies.
- 4) It shall be bound by all statements, representations, warranties, and guarantees made in the original proposal and the updated terms and conditions.
- 5) That all of the requirements of this contract renewal have been read and understood. In addition, compliance with all requirements, terms and conditions will be assumed by HCDE if not otherwise noted.
- 6) The individual signing below has authority to enter into this contract renewal on behalf of Vendor.
- 7) Vendor acknowledges that the Agreement may be canceled if any conflict of interest or appearance of a conflict of interest is discovered by HCDE.
- 8) This contract is subject to purchase orders duly authorized and executed by HCDE.

<b>CORPORATE NAME:</b>	Young Picassos		
<b>AUTHORIZED SIGNATURE:</b>	<i>Angelina Rodriguez</i>		
<b>PRINT NAME:</b>	Angelina H. Rodriguez		
<b>TITLE:</b>	Owner		
<b>DATE:</b>	05/18/2021		
<b>ADDRESS:</b>	4747 Bellaire Blvd., Ste. 545		
<b>CITY, STATE, ZIP CODE:</b>	Bellaire, TX 77401		
<b>PHONE:</b>	713-206-8429	<b>FAX:</b>	N/A
<b>EMAIL ADDRESS:</b>	info@youngpicassoshouston.com		

-----  
**This section to be completed by HCDE**

Contract Number: \_\_\_\_\_ Original term of contract: \_\_\_\_\_ to \_\_\_\_\_

Contract Renewal Term: \_\_\_\_\_ to \_\_\_\_\_ Number of Renewal Options Left \_\_\_\_\_

This contract renewal shall be for the period of one (1) year if agreed to by HCDE and awarded vendor.

Approved by Harris County Department of Education:

\_\_\_\_\_  
Jesus J. Amezcua, Ph.D., CPA, RTSBA  
**Assistant Superintendent for Business Services**

\_\_\_\_\_  
Approval Date

**Regular Board Meeting**

**8.F.3.**

**Meeting Date:** July 21, 2021

**Title:** Contract Renewal option for Job No. 19/050IA Contracted Services for TLC

**Submitted For:** Kendra Jackson, Purchasing

**Submitted By:** Inga Ash

**Recommended Action:** Approve

**HCDE Goal(s):** 2. Deliver value responsibly  
4. Provide cost savings by leveraging tax dollars

**Additional Resource Personnel:** Dr. Jesus J. Amezcua, Kendra Jackson, Inga Ash

**Facilities/Technology Approval Needed?:**

**Information**

**Posted Agenda Item:**

**Approval of Contract Renewal option for job no. 19/050IA - Contracted Services for the Teaching Learning Center with the following vendor:** PrepForward, for the period of 9/01/2021 through 8/31/2022.

**Subject:**

Contracted Services for the Teaching Learning Center

**Rationale:**

HCDE contract no. 19/050IA was awarded for one (1) year from of 9/1/2019 through 8/31/2020. This contract has the option for four (4) annual renewals.

HCDE recommends exercising the second (2nd) option for renewal period 9/01/2021 through 8/31/2022 for the vendor listed above in Posted Agenda Item. This contract is in accordance with Texas Education Code 44.031.

**Fiscal Impact**

**Attachments**

Execution of Offer

**Form Review**

**Inbox**

Purchasing (Originator)  
Purchasing (Originator)  
Assistant Superintendent - Business  
Form Started By: Inga Ash  
Final Approval Date: 07/06/2021

**Reviewed By**

Kendra Jackson  
Kendra Jackson  
Venetia Baldwin

**Date**

06/28/2021 02:03 PM  
06/30/2021 09:08 AM  
07/06/2021 09:58 AM  
Started On: 06/23/2021 04:52 PM

**HARRIS COUNTY DEPARTMENT OF EDUCATION  
EXECUTION OF OFFER – CONTRACT RENEWAL**

The undersigned company representative has carefully examined all instructions, requirements, specifications, terms, and conditions of the original proposal and this contract renewal and certifies:

- 1) It has the necessary experience, knowledge, abilities, skills, and resources to satisfactorily perform the requirements, specifications, terms and conditions of the original RFP.
- 2) All statements, information, and representations prepared and submitted in response to this contract renewal request are current, complete, true, and accurate.
- 3) It is not currently barred or suspended from doing business with the Federal government, any of the members represented, or any of their respective agencies.
- 4) It shall be bound by all statements, representations, warranties, and guarantees made in the original proposal and the updated terms and conditions.
- 5) That all of the requirements of this contract renewal have been read and understood. In addition, compliance with all requirements, terms and conditions will be assumed by HCDE if not otherwise noted.
- 6) The individual signing below has authority to enter into this contract renewal on behalf of Vendor.
- 7) Vendor acknowledges that the Agreement may be canceled if any conflict of interest or appearance of a conflict of interest is discovered by HCDE.
- 8) This contract is subject to purchase orders duly authorized and executed by HCDE.

<b>CORPORATE NAME:</b>	PrepForward		
<b>AUTHORIZED SIGNATURE:</b>	<i>Mary Stephens</i>		
<b>PRINT NAME:</b>	Mary Stephens		
<b>TITLE:</b>	CEO		
<b>DATE:</b>	6/12/2021		
<b>ADDRESS:</b>	31 Maynard Farm Circle		
<b>CITY, STATE, ZIP CODE:</b>	Sudbury, MA 01776		
<b>PHONE:</b>	617-299-6835	<b>FAX:</b>	
<b>EMAIL ADDRESS:</b>	mary@prepforward.com		

-----  
**This section to be completed by HCDE**

Contract Number: \_\_\_\_\_ Original term of contract: \_\_\_\_\_ to \_\_\_\_\_

Contract Renewal Term: \_\_\_\_\_ to \_\_\_\_\_ Number of Renewal Options Left \_\_\_\_\_

This contract renewal shall be for the period of one (1) year if agreed to by HCDE and awarded vendor.

Approved by Harris County Department of Education:

\_\_\_\_\_  
Jesus J. Amezcua, Ph.D., CPA, RTSBA  
**Assistant Superintendent for Business Services**

\_\_\_\_\_  
Approval Date

**Regular Board Meeting**

**8.F.4.**

**Meeting Date:** July 21, 2021

**Title:** Contract renewal for job no. 20/044KJ for Workers' Compensation Insurance for HCDE

**Submitted For:** Kendra Jackson, Purchasing

**Submitted By:** Kendra Jackson

**Recommended Action:** Approve

**HCDE Goal(s):**  
1. Impact education/respond to evolving needs  
5. Recruit high-quality professionals

**Additional Resource Personnel:** Natasha Truitt, Dr. Jesus Amezcua, Kendra Jackson, Inga Ash

**Facilities/Technology Approval Needed?:** None

**Information**

**Posted Agenda Item:**

**Approval of Contract Renewal option for job no. 20/044KJ for Workers' Compensation Insurance for HCDE through the Texas Association of School Boards (TASB) Risk Management Fund** (fully insured product) for the period of 09/01/2021 through 08/31/2022 and the contract with TASB Risk Management Fund for the period of 09/01/2021 through 08/31/2022 in the amount of \$395,211.00.

**Subject:**

Workers' Compensation Insurance

**Rationale:**

Renewal with the Texas Association of School Boards (TASB) Risk Management Fund for Workers' Compensation insurance coverage for all HCDE employees.

**Fiscal Impact**

**Attachments**

Renewal Form  
TASB Renewal Form

**Form Review**

**Inbox**

Purchasing  
Assistant Superintendent - Business  
Form Started By: Kendra Jackson  
Final Approval Date: 07/06/2021

**Reviewed By**

Kendra Jackson  
Venetia Baldwin

**Date**

06/30/2021 10:04 AM  
07/06/2021 09:58 AM  
Started On: 06/30/2021 09:48 AM



**HARRIS COUNTY DEPARTMENT OF EDUCATION  
EXECUTION OF OFFER – CONTRACT RENEWAL**

**\*The Fund confirms that the 2021-22 Workers’ Compensation renewal for Harris County Department of Education has no changes or exceptions from the terms and conditions provided in the original RFP #20/044KJ.**

- 1) It has the necessary experience, knowledge, abilities, skills, and resources to satisfactorily perform the requirements, specifications, terms, and conditions of the original RFP.
- 2) All statements, information, and representations prepared and submitted in response to this contract renewal request are current, complete, true, and accurate.
- 3) It is not currently barred or suspended from doing business with the Federal government, any of the members represented, or any of their respective agencies.
- 4) It shall be bound by all statements, representations, warranties, and guarantees made in the original proposal and the updated terms and conditions.
- 5) That all of the requirements of this contract renewal have been read and understood. In addition, compliance with all requirements, terms and conditions will be assumed by HCDE if not otherwise noted.
- 6) The individual signing below has authority to enter into this contract renewal on behalf of Vendor.
- 7) Vendor acknowledges that the Agreement may be canceled if any conflict of interest or appearance of a conflict of interest is discovered by HCDE.
- 8) This contract is subject to purchase orders duly authorized and executed by HCDE.

CORPORATE NAME:	<b>TASB Risk Management Fund</b>		
AUTHORIZED SIGNATURE:	<i>Dubravka H. Romano</i>		
PRINT NAME:	<b>Dubravka H. Romano</b>		
TITLE:	<b>Associate Executive Director Risk Management Services Texas Association of School Boards, Inc.</b>		
DATE:	<b>June 24, 2021</b>		
ADDRESS:	<b>PO Box 301</b>		
CITY, STATE, ZIP CODE:	<b>Austin, Texas 78767-0301</b>		
PHONE:	<b>800.482.7276 or 512.467.3699</b>	FAX:	<b>512.467.3645</b>
EMAIL ADDRESS:	<b>RFPUnderwriting@tasb.org</b>		

-----  
**This section to be completed by HCDE**

Contract Number: \_\_\_\_\_ Original term of contract: \_\_\_\_\_ to \_\_\_\_\_

Contract Renewal Term: \_\_\_\_\_ to \_\_\_\_\_ Number of Renewal Options Left \_\_\_\_\_

This contract renewal shall be for the period of one (1) year if agreed to by HCDE and awarded vendor.

Approved by Harris County Department of Education:

\_\_\_\_\_  
Jesus J. Amezcua, Ph.D., CPA, RTSBA  
**Assistant Superintendent for Business Services**

\_\_\_\_\_  
Approval Date



June 11, 2021

Natasha Truitt

Harris County Department of Education

Dear Natasha Truitt,

Strong risk management resources and reliable coverage partners are critical to managing operations at your organization. Thank you for trusting the TASB Risk Management Fund to support your efforts.

When you choose the Fund, you get more than a coverage provider. You get a stable ally that has served members for nearly five decades and is the choice of more than 1,000 Texas school districts and other educational entities for their risk management and coverage needs.

- **Financial Security:** The Fund's financial strength, with over \$200 million in Members' Equity, means we have the financial resources to handle your claims.
- **Responsive and Adaptable:** A risk pool, like the Fund, offers flexibility to customize coverage agreements to meet Texas public schools' unique needs. We pair a broad array of coverage options with comprehensive risk solutions so you can work compliantly, train and educate staff, and prevent and mitigate losses. We meet you where you are and deliver the services you need to navigate the ever-evolving risk landscape.
- **Trusted:** The Fund is administered by the Texas Association of School Boards (TASB), an organization founded on understanding the uniqueness of each school community in Texas. Led by a board of Texas public school board members and administrators, the Fund is focused on your needs.

We are pleased to provide you with a renewal proposal for the 2021–22 coverage term. As an added convenience, **you may accept your renewal proposal online**. There are no changes in the coverage agreements this year. Coverage agreements may be accessed on the Fund's website. Please carefully review all terms and when ready, complete your electronic acceptance on the page where you accessed these documents. Enter your first and last name and then click "Accept and Sign." You may also sign these documents and return them by email to your Risk Management Marketing Consultant or to [TASBRMF@tasbrmf.org](mailto:TASBRMF@tasbrmf.org).

**Please note that coverage will automatically renew under the terms of this renewal proposal unless we receive written notice of termination at least 30 days prior to your renewal date.** If you are unsure of your plans to renew or have any questions about the renewal proposal or any aspect of your Fund membership, please contact Rosa Brown or any member of TASB's Underwriting and Marketing Division at 800.482.7276.

Thank you for your membership in the Fund. We look forward to our continued partnership in the coming year.

Sincerely,  
Rosa Brown  
Senior Risk Management Consultant  
Division of Underwriting & Marketing  
Texas Association of Schools Boards, Inc.

TASB Risk Management Fund  
12007 Research Blvd., Austin, Texas 78759-2439  
P.O. Box 301, Austin, Texas 78767-0301  
Toll-Free: 800.482.7276 | Austin area: 512.467.3699

CC:



**Harris County Department of Education**

**Contribution & Coverage Summary (CCS)**  
**Participation Period: 9/1/2021 through 8/31/2022**

The following is a summary of coverages, limits, deductibles, and contribution amounts. More information about coverage, limits, deductibles, terms, and conditions are found on following pages and are part of this CCS. Please review all pages of this CCS document.

<b>Coverage</b>	<b>Limit</b>	<b>Deductible</b>	<b>Contribution</b>
<b>Workers' Comp Fully Funded</b>	Statutory	Statutory	<b>\$395,211</b>
<b>Total Contribution</b>			<b>\$395,211</b>

***THIS IS NOT AN INVOICE.*** The TASB Risk Management Fund will issue an invoice when coverage is accepted by the Member. Total Contribution is an estimate and is subject to exposure audit.



**Harris County Department of Education**

**Workers' Compensation – Fully Funded**

**Participation Period: 9/1/2021 through 8/31/2022**

**Total Workers' Compensation – Fully Funded Contribution: \$395,211**

The following is a summary of estimated payrolls and contribution for Workers' Compensation coverage. The amounts shown are subject to audit at the end of the Participation Period.

Classification	Estimated Payroll	Net Annual Rate	Estimated Contribution
7380 - BUS DRIVERS	\$44,450	0.03637824	\$1,617
8810 - CLERICAL OFFICE EMPLOYEES	\$13,146,492	0.00238497	\$31,354
8868 - PROFESSIONAL/ADMINISTRATON	\$29,976,402	0.00643963	\$193,037
9101 - ALL OTHERS	\$3,547,168	0.04770087	\$169,203
<b>Total</b>	<b>\$46,714,512</b>		<b>\$395,211</b>

<b>Estimated Contribution</b>	<b>\$395,211</b>
-------------------------------	------------------

**Workers' Compensation – Fully Funded Conditions**

**Benefit Limits:** Workers' Compensation benefits paid to Fund Member's employees under this Agreement will be as defined in the Texas Workers' Compensation Act (the Act). The Fund is responsible for claims payments as reflected in this CCS. This Agreement does not cover the defense of any suit or claim against a Fund Member except a workers' compensation claim by an eligible employee or former employee of Fund Member for the payment of statutory workers' compensation benefits.

**Cooperation:** The Fund Member designates the TASB Risk Management Fund as the Workers' Compensation claim administrator of record for all purposes. Fund Member agrees to use the Fund's contractors for services related to the administration of claims and to follow the Fund's election under Section 504.053 of the Labor Code to direct care through the Political Subdivision Workers' Compensation Alliance.

**Claims Reporting:** For Workers' Compensation claims arising during the CCS Participation Period, the Fund Member agrees that it will timely report those claims solely to the Fund. The report of Workers' Compensation claims to any other entity, regardless of reporting sequence, will waive all Fund liability under this agreement for those claims. Any fines levied against the Fund for Fund Member's failure to comply with the rules and regulations of the Act will be the sole responsibility of the Fund Member.



## Program Coordinators

The Fund Member is required to designate a Program Coordinator (Coordinator) with express authority to represent and bind the Fund Member in all program matters. Below are the current Coordinators associated with the Fund Member. If a Coordinator's name and e-mail address are not listed or the Coordinator identified needs to be updated, please provide updated information to the Fund as soon as possible or include updates on this document.

### Current Program Coordinators

Program	Name	Title	E-mail
TASB Risk Management Fund-Workers' Compensation	Natasha Truitt	Human Resources Executive Director	ntruitt@hcde-texas.org

### Program Coordinator Updates

Program	Name	Title	E-mail

If accepting this proposal electronically, you may scan and email this page to [tasbrmf@tasbrmf.org](mailto:tasbrmf@tasbrmf.org) to provide Program Coordinator updates.



## Contribution & Coverage Summary General Conditions

**Coverage:** Coverage terms and limits provided are as set out in this CCS and the Fund's corresponding Coverage Agreements for this Participation Period.

**Claims Reporting:** Fund Member will provide to the Fund timely notice of all claims as required in the Interlocal Participation Agreement, the applicable Fund Coverage Agreement, or this CCS.

**Definitions:** Any terms not defined in this CCS will use the definition for that term from the corresponding Fund Coverage Agreement.

**Payment:** The Fund Member agrees to pay contributions based on a plan developed by the Fund. All contributions are payable upon receipt of an invoice from the Fund. The Fund shall determine the contribution for each program and how each contribution is applied. Termination under this Agreement of any program shall not affect the remaining programs.

**Termination:** This CCS may be terminated by either party with termination to be effective on any successive renewal date by giving written notice to the other party no later than 30 days prior to automatic renewal in accordance with Termination provisions in the Interlocal Participation Agreement. If this CCS is not terminated, the renewal of the CCS becomes effective on the automatic renewal date and the member shall be bound by the terms of the renewal CCS.

### Fund Member Authorization:

I approve this Contribution and Coverage Summary (CCS) and certify that this information is correct. I affirm that I am duly authorized to approve this CCS and that I have read and agree to this CCS and the Interlocal Participation Agreement.

\_\_\_\_\_  
Authorized Signature

\_\_\_\_\_  
Date

\_\_\_\_\_  
Printed Name

\_\_\_\_\_  
Title

**Regular Board Meeting**

**8.F.5.**

**Meeting Date:** July 21, 2021

**Title:** RFP 21/051KJ - Depository Banking Services for HCDE

**Submitted For:** Kendra Jackson, Purchasing

**Submitted By:** Kendra Jackson

**Recommended Action:** Approve

**HCDE Goal(s):** 4. Provide cost savings by leveraging tax dollars

**Additional Resource Personnel:** Dr. Jesus J. Amezcua, Kendra Jackson

**Facilities/Technology Approval Needed?:**

**Information**

**Posted Agenda Item:**

**Approval of Contract Award for job no. 21/051KJ for Depository Banking Services** for HCDE with the following proposer: J.P. Morgan Chase Bank for the period of 09/01/2021 through 08/31/2023.

**Subject:**

Depository Banking Services for HCDE

**Rationale:**

The process enacted was a Request for Proposals (RFP) to acquire proposals from vendors to provide Depository Banking Services for HCDE. Nine hundred and ninety-nine (999) invitations were extended for proposals. Seven (7) responses were received from vendors. Each response was reviewed for compliance with the requirements of RFP, were evaluated, and scored. One (1) vendor offering the best value to HCDE was recommended for an award.

The contract period shall be for an initial term of two years beginning 09/01/2021 through 08/31/2023 with an option to extend three (3) additional two-year terms in accordance with the TEC §45.205(b) to the vendor stated above in Posted Agenda Item.

The legal provisions providing for the naming of a Depository of the Department are set forth in Subchapter G, School Department Depositories, Sections 45.201 through 45.209, of the Texas Education Code. Investments by the Department will be governed by the Government Code, Chapter 2256, Public Funds Investment. Securities pledged as collateral to secure Department deposits will be governed by the Government Code, Chapter 2257, Collateral for Public Funds.

**Fiscal Impact**

**Attachments**

- EC Form
- RFP Project Recap
- Participation Detail

**Form Review**

**Inbox**

Purchasing  
Assistant Superintendent - Business  
Form Started By: Kendra Jackson

**Reviewed By**

Kendra Jackson  
Jesus Amezcua

**Date**

06/28/2021 09:30 AM  
06/28/2021 02:13 PM  
Started On: 06/24/2021 11:08 AM





**Harris County Department of Education  
Business Office /Purchasing Division**

**EC Form**

**Effectiveness and Compliance Review**

[This form is used to document due diligence by Buyer]

---

To: Purchasing Audit File and Jesus J. Amezcua, Ph.D., CPA, Assistant Supt. for Business

From: Kendra Jackson –Director of Purchasing

Job- Bid or RFP# and Name: 21/051KJ – Depository Banking Services for HCDE

Board Meeting Date: July 21, 2021

Date: June 28, 2021

**Procurement Requirements Applicable:**

Check One

- Under \$2,500 (Requires Division Director and Asst Supt. Approval)
- From \$2,500 to \$49,999 (Requires Buyer, Purchasing Director/CFO Approval)
- Over \$50,000 (per CH Local)
- Cooperative Programs (Requires Board Approval)

I certify that I have reviewed the attached job (bid or RFQ) and certify that all of my actions as a Recommendations Committee Member are within the procurement requirements in accordance with local Board Policies (CH local/legal) and legal (federal and state) policies and administrative guidelines set by the Business Office and the Purchasing Division.

I certify that I have adhered to the Purchasing Policies of HCDE concerning the review of this job (bid or RFQ) to include policies on conflict of interest.

I certify that I am aware of all purchasing policies (CH Local and CH Legal) and administrative procedures of HCDE.

I certify that I am aware of the penalties of not following the purchasing policies and procedures and in specific with section 44.032 of the Texas Education Code which deals with the penalties related to sequential or component purchases.

I further certify that I recommend the issuance of a purchase order after Board approval and execution of a contract.

(Note: This form is required of all jobs (bids and RFQs) prepared by HCDE Purchasing Division)



June 24, 2021

Dr. Jesus Amezcua  
Assistant Superintendent – Business Services  
Harris County Department of Education  
6300 Irvington Blvd.  
Houston, TX 77022

Dear Dr. Amezcua:

We sincerely appreciated and welcomed the opportunity to assist the Harris County Department of Education (HCDE) with this Primary Depository Bank Services Request for Proposals (the “RFP”) project.

The objective of this engagement was to select a primary depository bank following the expiration of the current contract which ends August 31, 2021. This agreement, when approved, will commence on September 1, 2021 and terminate on August 31, 2023. At the option of HCDE, the contract may be extended for three (3) additional two-year periods under the same terms and conditions for a possible total term of eight (8) years.

In addition to soliciting for the Primary Depository Bank Services, the RFP included Merchant Services Processing, Procurement Card Processing, and Payroll Card Processing, with the goal of having one financial institution as the provider of all services.

### **Solicitation Process**

The project began with the establishment of a calendar of events to ensure that the required project steps were performed in a timely and sequential manner.

The process for selecting a depository bank is governed by various State of Texas statutes, including: Texas Education Code, Chapter 45, Subchapter G School Department Depositories; Chapter 176 Conflict of Interest Act; Chapter 2256 Public Funds Investment Act; and Chapter 2257 Public Funds Collateral Act.

In addition to complying with these State statutory requirements, it was necessary to understand and comply with HCDE’s financial and purchasing policies and Investment Policy.

The RFP project was conducted as follows:

1. Analyzed historical bank service usage and balance records.
2. Reviewed the minimum banking services and potential additional services.
3. Developed a list of seventy-five (75) eligible financial institutions within HCDE’s service area.

4. Contacted each of the financial institutions to confirm distribution information, describe the process, and identify the designated recipient.
5. Drafted the RFP for Department review and approval.
6. Posted the notice and advertised the RFP.
7. Distributed RFPs to the identified and receptive financial institutions.
8. Held a non-mandatory pre-proposal conference that was attended by representatives of:
  - a. Bank OZK
  - b. Cadence Bank, N.A.
  - c. Capital One, N.A.
  - d. Frost Bank
  - e. Independent Financial
  - f. JPMorgan Chase Bank, N.A. (Incumbent)
  - g. Plains Capital Bank
  - h. Texas Gulf Bank, N.A.
  - i. The Moody National Bank
9. By the closing deadline, proposals were received from:
  - a. Bank OZK
  - b. Cadence Bank, N.A.
  - c. Frost Bank
  - d. Independent Financial
  - e. JPMorgan Chase Bank, N.A (Incumbent)
  - f. Plains Capital
  - g. Texas Gulf Bank, N.A.
10. No additional RFP responses were received as a result of the advertisement.

The evaluation of the proposals was based on, but not limited to, the following criteria:

<u>Criteria</u>	<u>Weight</u>
a. Interest rates offered on demand or time deposits	10
b. Cost of Services (charges for keeping Department accounts, records, and reports and furnishing checks)	20
c. Ability to provide the necessary services and perform the duties as Depository	25
d. Any other matter that in the judgement of the Board of Trustees would be to the best interest of the Department	5
e. Current and or past relationship with the Department	10
f. Collateralization policy and type of third-party institutional holding collateral	10
g. Automated and additional services offered and available, and	10
h. Funds availability and deposit and payment cut-off times	10

## Proposal Analysis

Proposal response analysis began with an overall review of each financial institution’s general financial strength and ability to provide the services necessary to meet HCDE’s current and future service needs. Each of the qualified responding financial institutions exhibited acceptable financial strength and the ability to provide services that HCDE requested.

The next step was to review each financial institution’s fee schedule, which was analyzed based on HCDE’s banking service needs and estimated activity levels. The table below summarizes the estimated monthly fee proposed by each institution, along with their proposed earnings credit rate, floor rates offered, if any, and the interest rates offered on balances:

Summary of Estimated Monthly Fees and ECR and Interest Rates							
	JPMorgan Chase Bank (BAFO)	Bank OZK	Cadence Bank	Frost Bank	Independent Financial	PlainsCapital Bank	Texas Gulf Bank
<b>Estimated Fees (Monthly)</b>	(\$1,369.00)	(\$1,438.00)	(\$1,374.00)	(\$2,414.00)	(\$1,238.00)	(\$1,209.00)	(\$1,928.00)
<b>Earnings Credit Rate</b>	0.23%	0.35%	0.75%	0.25%	0.00%	0.25%	0.01%
<b>Floor Rate</b>	None	None	None	None	None	Low end of FED Funds Target currently 0.25%	30 Day T-Bill No Floor Currently 0.01%
<b>Interest Rate on Investible Balances</b>	0.16%	0.08%	0.03%	0.02%	Upper end of FED Funds Rate Currently 0.25%	Low end of FED Funds Target Floor 0.10%	30 Day T-Bill No Floor Currently 0.01%
<b>Floor Rate</b>	None	None	None	None	None	0.10%	None

The following contract incentives were also incorporated into the overall cost of each institution’s proposal.

Contract Incentives							
<b>Estimated Waived Fees</b>	16,430	0	1,374	7,242	0	0	0
<b>Retention and or Incentive Offer</b>	0	0	0	2,500	0	0	0
<b>Tamperproof Bags &amp;</b>	0	0	0	0	0	500	0

HCDE staff conducted an additional analysis by assigning a weight to the listed criteria and evaluating the strength of each proposal against the listed criteria and assigned weights. The bottom line of the Table reflects the ranking of the proposals based on the staffs internal evaluation.

Based on the overall evaluation which covered, service capabilities, cost of services, interest rates, and incentives offered, JPMorgan Chase’s proposal was deemed the most advantageous to HCDE with an overall score of 88.27 points.

As the top finalist, the staff met with representatives of JPMorgan Chase to discuss possible adjustments to their proposal as a ‘best and final’ offer. As a result of that meeting, the team from JPMorgan Chase agreed to increase their offered Earnings Credit Rate to 0.23% and to extend the period of fee waivers from nine months to the first twelve months of the new contract, resulting in additional savings for HCDE.

The analysis below is for both the two (2) year initial contract term, and the full eight (8) year term which provides for the three (3) possible two-year extensions at the option of HCDE.

Combined Bank, MSP and Pcard Net Costs							
	JPMorgan Chase Bank (BAFO)	Bank OZK	Cadence Bank	Frost Bank	Independent Financial	PlainsCapital Bank	Texas Gulf Bank
Two Years	2,193	(6,011)	11,552	(33,949)	(15,481)	(388)	(52,762)
Eight Years	(54,187)	(24,042)	41,336	(165,023)	(61,924)	(64,477)	(211,049)
Potential Bank Transition Expense (Hard and Soft Dollar)	0	(15,000)	(15,000)	(15,000)	(15,000)	(15,000)	(15,000)
Total for Eight Years	(54,187)	(39,042)	26,336	(180,023)	(92,405)	(79,477)	(226,049)
				NR	No Bid MSP		
Number of Branch Locations in Houston	95	4	10	27	6	4	2
Closest location to Harris County Department of Education	5207 Airline Drive, Houston, TX 77022	4328 Old Spanish Trail, Houston, TX 77021	909 Fannin, Houston, TX 77010	3500 Little York Road, Houston, TX 77093	4040 Washington Ave, Houston, TX 77007	5 Riverway, Suite 100, Houston, TX 77056	1626 South Voss Road, Houston, TX 77057
Distance from office to closest location (per Google Maps)	3.6 Miles 7 Mins	11.5 Miles 22 Mins	5.6 Miles 12 Mins	6.4 Miles 11 Mins	6.1 Miles 11 Mins	8.8 Miles 14 Mins	12.3 Miles 20 Mins
Total HCDE Evaluation Score	88.27	82.49	73.98	83.87	79.88	76.05	50.80

Note that the Frost proposal was considered to be non-responsive (NR) because they did not provide a fee schedule from which a meaningful estimate could be developed. Independent Financial does not offer Merchant Services Processing and did not offer a bid for that part of the requested services.

### Recommendation

As the incumbent, JPMorgan Chase has been a sound and stable business partner for HCDE over the past depository contract term and after all proposals were reviewed, HCDE is confident that they will continue to provide the highest level of service that HCDE has come to expect.

We concur with the staff recommendation that the Board of Trustees award the Primary Depository Bank Services contract to JPMorgan Chase Bank, N.A., which will include Merchant Services and Procurement Card processing, and authorize the Superintendent to execute the agreements necessary to implement the total banking relationship.

Upon approval, the new contract will commence on Sunday, September 1, 2021.

Please contact Dick Long, E.K. Hufstедler, Tom Ross or me to discuss any questions or additional information needs.

Thank you for this opportunity to serve the Harris County Department of Education.

Sincerely,



Tim Pinon  
Valley View Consulting, L.L.C.

# Harris County Department of Education

## Participation Detail as of 6/28/2021 08:54:44 AM (CT)

### Bid Information

Bid Creator Kendra Jackson Assistant Director  
 Email kjackson@hcde-texas.org  
 Phone (713) 696-0744  
 Fax (713) 696-0720  
  
 Bid Number 21/051KJ Addendum 2  
 Title Depository Banking Services  
 Bid Type Request for Proposal  
 Issue Date 4/23/2021 03:01 PM (CT)  
 Close Date 5/25/2021 02:00:00 PM (CT)

### Participation Summary

Company Name	City, State	Invitation Date	Status	Status Date	Response Date
@RISK Technologies	Dallas, TX	04/23/2021			
2 Inspire Peace	Dallas, TX	04/23/2021			
2*2*4 Solutions Education Consulting Service	Red Oak, TX	04/23/2021			
365 Media (365 Media LLC)	Portsmouth, NH	04/23/2021			
365 Paving & Construction LLC	Mission, TX	04/23/2021			
3rd I Process FX	Houston, TX	04/23/2021			
4.0 GPA	Houston, TX	04/23/2021			
4kboards	Keller, TX	04/23/2021			
4W Solutions, Inc	Houston, TX	04/23/2021			
7Mindsets	Roswell, GA	04/23/2021			
806 Technologies, Inc.	Plano, TX	04/23/2021			
A & R Holdings, LLC	Jacksonville, FL	04/23/2021			
A Better Resolutions, LLC	Houston, TX	04/23/2021			
A,N,H. Consulting, LLC.	New Orleans, LA	04/23/2021			
A.I.M. (Assessment Intervention Management, LLC)	San Antonio, TX	04/23/2021			
AAA Painting	Houston, TX	04/23/2021			
ABS (RJ Braniff Corporation)	Houston, TX	04/23/2021			
Abundance Educational Consulting, LLC	Humble, TX	04/23/2021			
AC Language School (Chavez & Associates)	Sugar Land, TX	04/23/2021			
Academic Learning Company (Velazquez Press)	El Monte, CA	04/23/2021			
Aceves Communications	Houston, TX	04/23/2021			
ACFS Security, LLC	Katy, TX	04/23/2021			
Achor Counseling & Associates LLC	HOUSTON, TX	04/23/2021			
ACS Engineering & Safety	Spring, TX	04/23/2021			
Acumen Enterprises, Inc.	Desoto, TX	04/23/2021			
AdaptiveX (Test4Me LLC)	Glenarden, MD	04/23/2021			
Adele's Coaching and Consulting	Missouri City, TX	04/23/2021			
Adira LLC	Savannah, TX	04/23/2021			
AdjuStar Services, Inc.	Houston, TX	04/23/2021			
ADMORE BEHAVIORAL THERAPY	Houston, TX	04/23/2021			
ADP, Inc.	Houston, TX	04/23/2021			
Adrian Garcia	Brownsville, TX	04/23/2021			
Advance Plus Therapy Services, LLC	Pasadena, TX	04/23/2021			
Advance Professional Consultants, LLC	Houston, TX	04/23/2021			
ADVANTAGE BENEFIT SOLUTIONS (Stefanick Insurance Services Inc.)	Houston, TX	04/23/2021			
Adwebvertising, LLC (Nick Covanes)	Katy, TX	04/23/2021			
AECOM (AECOM Technical Services Inc)	Houston, TX	04/23/2021			
Agular Systems, Inc.	Austin, TX	04/23/2021			
Agundez Inc, DBA Central Graphics	Houston, TX	04/23/2021			
Ajg	League city, TX	04/23/2021			
Alamo HR	San Antonio, TX	04/23/2021			
Alamo Music Center, Inc.	San Antonio, TX	04/23/2021			
Alba Educational Consulting, LLC	Kingwood, TX	04/23/2021			

Albert Johnson III, Inc.	Pearland, TX	04/23/2021			
Albom Translation Services (Albom & Associates, LLC)	Arlington, VA	04/23/2021			
Alegna Technologies, Inc.	Kennesaw, GA	04/23/2021			
ALIrving Enterprises LLC	San Antonio, TX	04/23/2021			
ALL AMERICAN SPECIALTY CONSTRUCTION LLC	IRVING, TX	04/23/2021			
All Educate Learning Resources	Livingston, TX	04/23/2021			
ALL VALLEY DRUG SCREENS	Brownsville, TX	04/23/2021			
Alliance Financial Ministries, Inc.	Pearland, TX	04/23/2021			
Allovue	Baltimore, MD	04/23/2021			
ALPHA Facilities Solutions	San Antonio, TX	04/23/2021			
AlphaGraphics (Lukitas Inc.)	Houston, TX	04/23/2021			
ALTERING THE EDUCATION XPECTATION LLC	Evanston, IL	04/23/2021			
Altitude Learning (AltSchool, PBC d/b/a Altitude Learning)	San Francisco, CA	04/23/2021			
Amaanah Refugee Services	Houston, TX	04/23/2021			
aMaezing Marketing Group dba Stryker-Munley Group (aMAEZing Marketing Group)	San Antonio, TX	04/23/2021			
Amanda Holdsworth Communications	South Lyon, MI	04/23/2021			
American Fire Systems Inc.	HOUSTON, TX	04/23/2021			
American Productivity & Quality Center	Houston, TX	04/23/2021			
American Vision Marketing LLC	Stafford, TX	04/23/2021			
Amparo Consulting & Design	Grand Junction, CO	04/23/2021			
AMTEX Security Inc.	Corpus Christi, TX	04/23/2021			
Anew Psychological Services, PLLC	Houston, TX	04/23/2021			
AnLar, LLC	Arlington, VA	04/23/2021			
Ann Marie Harbour	Richmond, TX	04/23/2021			
Antonia Y. Hamm	Humble, TX	04/23/2021			
APIA Source (APIA Source LLC)	Saginaw, TX	04/23/2021	No Bid	05/06/2021	05/06/2021
Apple Developmental Health	Houston, TX	04/23/2021			
Applications Software Technology Corporation	Naperville, IL	04/23/2021			
Aptim Environmental & Infrastructure	Baton Rouge, LA	04/23/2021			
Arctic Information Technology, Inc.	Anchorage, AK	04/23/2021			
ardurra group	houston, TX	04/23/2021			
Argument-Driven Inquiry	Austin, TX	04/23/2021			
ARMI Consulting (Account Receivable Management, Inc.)	Orlando, FL	04/23/2021			
ARRAY	Bellaire, TX	04/23/2021			
Arthur J Gallagher, Inc.	Huntington Beach, CA	04/23/2021			
Arts Alive! Inc (ARTS ALIVE!)	Houston, TX	04/23/2021			
As We Grow Learning Center	Houston, TX	04/23/2021			
ASA Builders, Inc	pasadena, TX	04/23/2021			
ASAP Business Services (Accurate Standards Available Professionals Business Services, LLC)	Houston, TX	04/23/2021			
ASAP Roofing (Koppel & Kozel, LLC)	Tyler, TX	04/23/2021			
ASD Consultants, Inc.	Austin, TX	04/23/2021			
Ashita.Design, LLC	Humble, TX	04/23/2021			
ASmart Consulting	Houston, TX	04/23/2021			
Aspell Services, Inc.	SAN ANTONIO, TX	04/23/2021			
Aspire Works LLC	San Antonio, TX	04/23/2021			
Assoc for the Advancement of Mexican Americans (AAMA)	Houston, TX	04/23/2021			
Astrov & Associates	Frisco, TX	04/23/2021			
AT&T Mobility LLC	Bellaire, TX	04/23/2021			
Atkins Powerhouse Consulting LLC	Fort Worth, TX	04/23/2021			
Atlas Civil Engineering PLLC	Houston, TX	04/23/2021			
Audimation Services Inc	Houston, TX	04/23/2021			
Auspicious Labs Inc. (same)	Houston, TX	04/23/2021			
AUSTIN LEARNING CENTER (CANDEO, LLC)	AUSTIN, TX	04/23/2021			
Automated Financial Systems (Robert Beyer Enterprises LLC)	San Antonio, TX	04/23/2021			
Baked With Confidence	Houston, TX	04/23/2021			
Balance Companies (Balance Group, LLC)	Houston, TX	04/23/2021			
Bank of America N.A.	Houston, TX	04/23/2021			
Bank of Texas (BOKF, NA)	Houston, TX	04/23/2021			



Bank OZK	Little Rock, AR		Submitted	05/21/2021	05/21/2021
Bara Infoware Inc.	Danville, CA	04/23/2021			
Barranco Educational Assessment, Counseling, and Consulting Svcs., PLLC	Montgomery, TX	04/23/2021			
Barstone, Inc.	San Antonio, TX	04/23/2021			
Battleground WTS	Houston, TX	04/23/2021			
BB&T	Winston Salem, NC	04/23/2021			
BBeauti AndLashes LLC	Houston, TX	04/23/2021			
BBVA Compass	Houston, TX	04/23/2021			
BCA DX LABORATORY	Livingston, TX	04/23/2021			
BCS Consulting	Humble, TX	04/23/2021			
BDK And Associates LLC	Colleyville, TX	04/23/2021			
BE GLAD LLC	San Jose, CA	04/23/2021	No Bid	04/27/2021	04/27/2021
BE Staffing Solutions LLC	Houston, TX	04/23/2021			
BEAL Safety and Performance	Sugar Land, TX	04/23/2021			
Bearing Fruit Early Childhood Training	HOUSTON, TX	04/23/2021			
Bedden & Associates, LLC (Bedden)	Richmond, VA	04/23/2021			
Bee Busy Wellness Center	Houston, TX	04/23/2021			
Bell and Smarts	Broken Arrow, OK	04/23/2021			
Belt Harris Pechacek	Houston, TX	04/23/2021			
BenCheri Educational Center	Houston, TX	04/23/2021			
Benchmark Displays, LLC	Palm Desert, CA		Viewed	05/12/2021	
BenefitScape (Benefit Coordinators of America, LLC)	Natick, MA	04/23/2021			
BENNETT MANAGEMENT SOLUTIONS LLC	Spring, TX	04/23/2021			
Best Lead Generation LLC	Conroe, TX	04/23/2021			
Best Practice Associates, Inc.	Houma, LA	04/23/2021			
BIAS Corporation	Atlanta, GA	04/23/2021			
Billtrust	Hamiton, NJ	04/23/2021			
Bio-Rad Laboratories, Inc	Hercules, CA	04/23/2021			
Black Topaz Consulting	Austin, TX	04/23/2021			
Black United Fund of Texas	Houston, TX	04/23/2021			
BlackBeltHelp	Chicago, IL	04/23/2021			
Blaylock Van, LLC	New York, NY	04/23/2021			
BLU PHIRE RESEARCH INSTITUTE INC	HOUSTON, TX	04/23/2021			
BluGreen Pest Control	Wallis, TX	04/23/2021			
BMHR - Better Man HR LLC	SAN ANTONIO, TX	04/23/2021			
BOLDplanning (BOLDplanning, inc)	Nashville, TN	04/23/2021			
Bond Program Management Services	Richards, TX	04/23/2021			
BookerDezigns	Richmond, TX	04/23/2021			
Bookwhisperer, Inc. (Donalyn Miller)	Colleyville, TX	04/23/2021			
Boundaryless Enterprises, LLC	Houston, TX	04/23/2021			
Bracane Company	Plano, TX	04/23/2021			
Brahmarsk Corporation	Sugar Land, TX	04/23/2021			
BrainStorm Advanced Learning Systems	Mansfield, TX	04/23/2021			
Brandi Spencer Consulting	Spring, TX	04/23/2021			
Brandi T. Brown	Manvel, TX	04/23/2021			
Braun Intertec Corporation	Houston, TX	04/23/2021			
BRB Supply	Houston, TX	04/23/2021			
Briar Patch	Houston, TX	04/23/2021			
Bridge to Leadership, LLC	Missouri City, TX	04/23/2021			
Bridgepoint Consulting, LLC	Austin, TX	04/23/2021			
Brighter Futures Counseling and Consulting	Houston, TX	04/23/2021			
Bruce Monical Design	Bacliff, TX	04/23/2021			
BTS Consulting (Business Trade and Services, inc.)	Doral, FL	04/23/2021			
Building Solutions	dallas, TX	04/23/2021			
Bureau of Education & Research	Bellevue, WA	04/23/2021			
Business & Financial Management Solutions, LLC	Austin, TX	04/23/2021			
BUSINESS 101 CONSULTANTS & TRAINERS	Houston, TX	04/23/2021			
C Change Consulting	Houston, TX	04/23/2021			
C1S Group, Inc.	Dallas, TX	04/23/2021			
Cadence Bank	houston, TX	04/27/2021	Submitted	05/25/2021	05/25/2021
cain & co llc	Concord, TX	04/23/2021			
CALPAA Inc (CALPAA, Inc)	Seattle, WA	04/23/2021			
Cam Light Enterprise Inc.	Conroe, TX	04/23/2021			

Camelback Displays Inc.	Spring, TX	04/23/2021			
Canyon Insurance Group	Houston, TX	04/23/2021			
Caperton-Brown & Poole Consulting	Ft. Pierce, FL	04/23/2021			
Capital One Bank	McLean, VA	04/27/2021	No Bid	04/28/2021	05/03/2021
Capitol Region Education Council	Hartford, CT	04/23/2021			
Career Resource Center	HUMBLE, TX	04/23/2021			
Carmen A. Handy	Corpus Christi, TX	04/23/2021			
Carol Cooper dba N&C Consulting	Garland, TX	04/23/2021			
Casablanca Productions	Spring, TX	04/23/2021			
Catapult Dreams, LLC	Pearland, TX	04/23/2021			
CBRE   Heery (CBRE Heery, Inc.)	Houston, TX	04/23/2021			
CBRE Valuation & Advisory Services	Houston, TX	04/23/2021			
CBTS Technology Solutions	Cincinnati, OH	04/23/2021			
CC Assessment Services, Inc	Houston, TX	04/23/2021			
CCS Global Tech (California Creative Solutions, Inc)	Poway, CA	04/23/2021			
CDR Maguire, Inc.	Miami, FL	04/23/2021			
CELLULAR WHOLESALERS, INC	Medley, FL	04/23/2021			
Center for Student Achievement Solutions	New York, NY	04/23/2021			
Center for Toxicology and Environmental Health, LLC.	North Little Rock, AR	04/23/2021			
Central IT Company LLC	Houston, TX	04/23/2021			
Certica Solutions	Wakefield, MA	04/23/2021			
CharacterStrong, LLC	PUYALLUP, WA	04/23/2021			
Charbonnet & Associates	New Orleans, LA	04/23/2021			
Chart Chicks LP	Lufkin, TX	04/23/2021			
Charter School Success, LLC	Galveston, TX	04/23/2021			
Chase in Dreams, Speech and Drama (Deadra Chase)	Houston, TX	04/23/2021			
CHAT (Culture of Health-Advancing Together)	Houston, TX	04/23/2021			
Chazey Partners (Chazey Partners Inc)	Campbell, CA	04/23/2021			
Cheryl R. Vital	Crosby, TX	04/23/2021			
Child Care Associates	FORT WORTH, TX	04/23/2021			
Child Champ Photography (Jody Goldstein)	Houston, TX	04/23/2021			
Childcare Masters LLC	Cypress, TX	04/23/2021			
Cindy Puryear Consulting Services (Cindy Puryear)	Houston, TX	04/23/2021			
Clark Hill Strasburger (Clark Hill PLC)	Houston, TX	04/23/2021			
Classware Systems (Classware L.P.)	Dallas, TX	04/23/2021			
cLI-Energy and Construction LL	Houston, TX	04/23/2021			
Clifton Gunderson LLP	Milwaukee, WI	04/23/2021			
Clinical Concepts! (The Entermedia Group, LLC)	Austin, TX	04/23/2021			
Club SciKidz Houston (Heir Consulting Group)	Houston, TX	04/23/2021			
Coaching Consultants Team	Houston, TX	04/23/2021			
Coatings Specialty Development Lab	Cypress, TX	04/23/2021			
Code Park Inc	Houston, TX	04/23/2021			
CohnReznick LLP	Austin, TX	04/23/2021			
Collaborate With Christina	Houston, TX	04/23/2021			
Color of Life (Color of Life Community Resource & Activity center)	Houston, TX	04/23/2021			
Comflow Mechanical Services	Houston, TX	04/23/2021			
Commerce Bank (Commerce Bancshares, Inc.)	Kansas City, TX	04/23/2021			
Communities In Schools of Houston	Houston, TX	04/23/2021			
(Communities In Schools of Houston, Inc.)					
Community Nutrition Outreach Services (Ellis A Morrow)	Houston, TX	04/23/2021			
Comprehensive Cloud Services	Houston, TX	04/23/2021			
CompuGroup Medical	Phoenix, AZ	04/23/2021			
Conscious Education Consulting, LLC.	Katy, TX	04/23/2021			
Consolidated Performance Consulting, LLC.	San Antonio, TX	04/23/2021			
Construction Journal	Stuart, FL	04/23/2021			
Control Systems Solutions, Inc.	Houston, TX	04/23/2021			
Convergent Nonprofit Solutions	Atlanta, GA	04/23/2021			
CoolSpeak, LLC	Pottstown, PA	04/23/2021			
Cooperative Strategies	Dublin, OH	04/23/2021			
Copy.com (Copydotcom, Inc.)	Houston, TX	04/23/2021			
CORE construction services of Texas, Inc.	Frisco, TX	04/23/2021			

Cossey's Services, LLC	The Woodlands, TX	04/23/2021		
Costello, Inc.	Houston, TX	04/23/2021		
Council Rock Enterprises, LLC	Rochester, NY	04/23/2021		
Covid Safety Glass (Silent West LLC)	LAS VEGAS, NV	04/23/2021		
CPS HR Consulting (Cooperative Personnel Services)	Sacramento, CA	04/23/2021		
CRAFT SAFETY INSPECTIONS (JMAC GROUP LLC)	HOUSTON, TX	04/23/2021		
Creative Circle, LLC	Los Angeles, CA	04/23/2021		
Creative Financial Staffing Inc	Houston, TX	04/23/2021		
Creatively Inspired Communications (ConSandra Jones)	Austin, TX	04/23/2021		
CReed Global Enterprises (CReed Global Media & Production)	Houston, TX	04/23/2021		
Crimson Vision Enterprises	Dickinson, TX	04/23/2021		
Crowe LLP	Oakbrook Terrace, IL	04/23/2021		
Crystal Clear Business Solutions	Sugar Land, TX	04/23/2021		
CVS Pharmacy, Inc.	Woonsocket, RI	04/23/2021		
Cyberstar, LLC	Austin, TX	04/23/2021		
Cyclone FPV (Cyclone 3D, Inc.)	Spring, TX	04/23/2021	Viewed	05/16/2021
D&M Leasing (Commercial Vehicle Leasing, LP)	Fort Worth, TX	04/23/2021		
D.A. Lamont Public Adjusters	Springtown, TX	04/23/2021		
Daintree Solutions LLC	Richmond, TX	04/23/2021		
Dalton Air Conditioning and Heating (Dalton Air Conditioning and Heating, LLC)	Pearland, TX	04/23/2021	No Bid	05/05/2021 05/05/2021
Dan L. Duncan Tutoring a part of the Children's Learning Institute (University of Texas Health Science Center)	Houston, TX	04/23/2021		
Dan St. Romain Educational Consulting, LLC	Universal City, TX	04/23/2021		
Dana Lee	Texas City, TX	04/23/2021		
Danny Steele (Daniel J. Steele)	Birmingham, AL	04/23/2021		
Data Facts, Inc	Cordova, TX	04/23/2021		
David James (David Hebert)	KEMAH, TX	04/23/2021		
David Rodriguez	San Antonio, TX	04/23/2021		
David Santana	Houston, TX	04/23/2021		
David Webb	Pasadena, TX	04/23/2021		
DB3 Unlimited Services LLC	San Antonio, TX	04/23/2021		
dba Stenhouse Publishers and dba Staff Development for Educators (SDE, Inc.)	Portsmouth, NH	04/23/2021		
Deacon Hill Research Associates LLC	Fredericksburg, VA	04/23/2021		
Debbie J. Anders Consulting	Cypress, TX	04/23/2021		
Decisions	Houston, TX	04/23/2021		
DeDe Church & Associates, LLC	AUSTIN, TX	04/23/2021		
Defined Learning	Northbrook, IL	04/23/2021		
DEMS,LLC	Houston, TX	04/23/2021		
Designum Media Group	New Orleans, LA	04/23/2021		
DG Grafix	Houston, TX	04/23/2021		
DGR United	houston, TX	04/23/2021		
Diamond Business Services, Inc.	Amarillo, TX	04/23/2021		
DIBSYS Inc	Naperville, IL	04/23/2021		
DigitalGenetix	San Antonio, TX	04/23/2021		
Dillon Claims & Consulting Services LLC	gonzales, LA	04/23/2021		
Disciplers Inc	Spring, TX	04/23/2021		
DiscoverU	Houston, TX	04/23/2021		
Diverse Consulting Enterprises, Inc.	HOUSTON, TX	04/23/2021		
Divine Dance (Peaceful Beginnings Montessori)	houston, TX	04/23/2021		
DK High Steppers (Doris Keener)	Houston, TX	04/23/2021		
DMS Disaster Consultants	Boca Raton, FL	04/23/2021		
Doherty and Associates Inc.	Wilmington, DE	04/23/2021		
DoLogic Inc.	Annandale, VA	04/23/2021		
Donald May	Adkins, TX	04/23/2021		
Doucet & Associates, Inc.	Austin, TX	04/23/2021		
Dr. Jeanne M. Hines	Port Arthur, TX	04/23/2021		
Dr. Ken Brumfield, Learning Empire	Santa Ana, CA	04/23/2021		
Dr. Mary E. White International, LLC	Houston, TX	04/23/2021		
Dr. Mike!	Wimberely, TX	04/23/2021		
Dr. Pope's STEM and Liberal Arts Academy	Pearland, TX	04/23/2021		

Dream Capital International, Inc	Houston, TX	04/23/2021			
DYS HOUSYON YOUTH ASSOCIATION	Houston, TX	04/23/2021			
E3 Alliance	Austin, TX	04/23/2021			
Earl P. Forbrich, Jr. Inc	San Antonio, TX	04/23/2021			
Early Start Development Inc	Humble, TX	04/23/2021			
E-Colors in Education	Austin, TX	04/23/2021			
EDU Specialist, LLC	Lake Dallas, TX	04/23/2021			
Educate To Edify (Educating While Black)	Pearland, TX	04/23/2021			
Education & Business Associates, Inc.	DeSoto, TX	04/23/2021			
Education Partners Solution, Inc.	Sugar Land, TX	04/23/2021			
Education Solutions Now, LLC	Houston, TX	04/23/2021			
Educational Epiphany LLC	WASHINGTON, DC	04/23/2021			
Educational Leadership Consultants	Houston, TX	04/23/2021			
Educational Research and Consulting, PLLC (Cynthia H. Williams, PhD)	Little Rock, AR	04/23/2021			
Educational Systems Consulting	Binghamton, NY	04/23/2021			
Edwards Sutarwalla PLLC	Houston, TX	04/23/2021			
Eichelbaum Wardell Hansen Powell & Mehl,	Austin, TX	04/23/2021			
Elaine Lange	Austin, TX	04/23/2021			
Electric Car Insider (Christopher Alan Consulting)	Spring Valley, CA	04/23/2021			
Elegant Enterprise Wide Solutions, Inc.	Chantilly, VA	04/23/2021			
Elevated Insights	Colorado Springs, CO	04/23/2021			
Elisa Rankin Consulting LLC	Uvalde, TX	04/23/2021			
Elite Change Inc.	Houston, TX	04/23/2021			
Elite Image Tax & Notary Service LLC	Houston, TX	04/23/2021			
Ellington Chastain Educational Initiative	San Antonio, TX	04/23/2021			
E-Logic, Inc.	Washington, DC	04/23/2021			
Emdin Support Services LLC	Bronx, NY	04/23/2021			
Emergent Professional Resources LP	Houston, TX	04/23/2021			
Emergent Risk Solutions	BATON ROUGE, LA	04/23/2021			
Emergent Tree Education	Austin, TX	04/23/2021			
Emma Oliver	Houston, TX	04/23/2021			
empower retirement (great-west life and annuity)	greenwood village, CO	04/23/2021			
Empowered Network Services, LLC	Huffman, TX	04/23/2021			
Energard Technologies (Ontracor, Inc.)	Lynnwood, WA	04/23/2021			
Energy Saving Advisor Distributors	Dallas, TX	04/23/2021			
engage2learn (Engage! Learning, Inc. dba engage2learn)	Portland, TX	04/23/2021			
Enterprise Fleet Management, Inc.	St. Louis, MO	04/23/2021			
Enterprise Pals, Inc.	Olathe, KS	04/23/2021			
ENTRAM CORP	PORT CHARLOTTE, FL	04/23/2021			
ERASCOGroup, LLC	Houston, TX	04/23/2021			
eRate 360 Solutions	Henderson, NV	04/23/2021			
E-Rate Elite Services, Inc.	Owings Mills, MD	04/23/2021			
Essential Wellness and Balance	Missouri City, TX	04/23/2021			
eTeachingMe (Love N Learn At Home)	Georgetown, TX	04/23/2021			
Eternal Media Solutions (Eternal Media Solutions LLC)	Katy, TX	04/23/2021			
Etrainers.org	Machesney Park, IL	04/23/2021			
Evergreen Solutions, LLC	Tallahassee, FL	04/23/2021			
Evolve Holdings Inc	Houston, TX	04/23/2021	No Bid	04/23/2021	04/23/2021
Ewing Strategic Communications	Houston, TX	04/23/2021			
Exceptional Pediatric Therapy, LLC	Houston, TX	04/23/2021			
ExecuTeam Staffing	Houston, TX	04/23/2021			
ExerPlay, Inc	Cedar Crest, NM	04/23/2021			
Exploros (Exploros, Inc.)	Wayland, MA	04/23/2021			
EXPRESSIONS PRODUCTIONS (1972)	Houston (and vicinity), TX	04/23/2021			
EY (Ernst & Young LLP)	Austin, TX	04/23/2021			
Facelift Graphics	Fresno, TX	04/23/2021			
FACILITIES INTEGRATED SOLUTIONS & CONSULTING LLC	CYPRESS, TX	04/23/2021			
Facility Engineering Associates, PC	Fairfax, VA	04/23/2021			
Faith Works Consulting Group, LLC	Houston, TX	04/23/2021			
Fannbassllc (Joseph Ball)	VA , Beach, VA	04/23/2021			
Fast Forward	Las Vegas, NV	04/23/2021			
FASTSIGNS 2073	GALVESTON, TX	04/23/2021			
Favor Consulting Inc (Demlan Solutions Inc)	Southlake, TX	04/23/2021			

Fazzio Consulting, LLC.	Round Rock, TX	04/23/2021			
Felicity Educational Services	Deerfield, IL	04/23/2021			
Ferrilli	Haddonfield, NJ	04/23/2021			
Finest Blood	Houston, TX	04/23/2021			
Fireworx International, LLC	Spring, TX	04/23/2021			
FIRST Educational Resources, LLC	Winneconne, WI	04/23/2021			
Floral Park Consulting LLC	Floral Park, NY	04/23/2021			
Foodservice Peeps LLC	Richmond, TX	04/23/2021			
For The Culture Literacy Development	Humble, TX	04/23/2021			
Forged Ed	Houston, TX	04/23/2021			
Fortify Experts, LLC (Energy Sourcing LLC)	Houston, TX	04/23/2021			
Foston International Communications Inc.	Richmond, TX	04/23/2021			
Frame-Work Consult	HOUSTON, TX	04/23/2021			
Freedom Profit Recovery (FPR Holdings, LP)	Irving, TX	04/23/2021			
Freese and Nichols, Inc.	Fort Worth, TX	04/23/2021			
Friends of the British Council USA Inc.	Washington, DC	04/23/2021			
From The Ground up Performance Enhancement (Deanna Voltz)	Houston, TX	04/23/2021			
From The Heart International Educational Services	Nashville, TN	04/23/2021			
FrontGate HR	Lubbock, TX	04/23/2021			
Frontier Services Group	Houston, TX	04/23/2021			
Frost Bank	Dallas, TX	04/23/2021	Submitted	05/24/2021	05/24/2021
Fullidity LLC	Houston, TX	04/23/2021			
Furness Law	Houston, TX	04/23/2021			
G S McCoy Inc PC	Houston, TX	04/23/2021			
G4C Enterprises, LLC	Pflugerville, TX	04/23/2021			
Gary Polland P.C.	Houston, TX	04/23/2021			
Garza/Gonzalez & Associates	San Antonio, TX	04/23/2021			
Gastile Consultant Group	Houston, TX	04/23/2021			
Gateway Solutions inc	overland park, KS	04/23/2021			
Gazelle Capital, LLC	Saint Petersburg, FL	04/23/2021			
Geaux Crates & Storage, LLC	Houston, TX, TX	04/23/2021			
Generation Ready	New York, NY	04/23/2021			
Generation Teach Inc.	Boston, MA	04/23/2021			
Gene's Machine, INC.	Victoria, TX	04/23/2021			
Gentle Minds Tutoring	Missouri City, TX	04/23/2021			
GermBlast (Infection Controls, Inc.)	Lubbock, TX	04/23/2021			
GET Technology and Accounting Solutions	Santo, TX	04/23/2021			
Getting Sorted (G. Yess Fisher & Co., LLC)	The Woodlands, TX	04/23/2021			
Gibson Consulting Group	Austin, TX	04/23/2021			
Gifting Grounds	Houston, TX	04/23/2021			
Gilberto D. Soto	Laredo, TX	04/23/2021			
GilCat Solutions (Gloria Lastra)	Spring, TX	04/23/2021			
Girlstart	Austin, TX	04/23/2021			
Glass View of Tech	Spring, TX	04/23/2021			
Global Education Systems Alliance (William H Prouty PhD)	Sun City, CA	04/23/2021			
GLOBAL EDUCATIONAL SOLUTIONS LLC	Canton, MI	04/23/2021			
GMC CONSULTANTS,LLC	Houston, TX	04/23/2021			
GMP Media Group	Atlanta, GA	04/23/2021			
GO M PAC	Houston, TX	04/23/2021			
GOD FEARING POWER HOUSE (POWER ROCK COMMUNITY CENTR)	HOUSTON, TX	04/23/2021			
Golden Mountain Consulting L.L.C	Houston, TX	04/23/2021			
GO-Strategic Management Services	Houston, TX	04/23/2021			
GovSense	Alpharetta, GA	04/23/2021			
GPR Ventures, LLC	Montgomery, TX	04/23/2021	No Bid	04/23/2021	04/23/2021
Gray Mechanical (Gray Mechanical, LLC)	Houston, TX	04/23/2021			
Gray Step Software	El Dorado Hills, CA	04/23/2021			
Gray&Pape, Inc.	Cincinnati, OH	04/23/2021			
Greatest in the Kingdom Ministries	The Woodlands, TX	04/23/2021			
Green Delete Inc.	Frankfort, IL	04/23/2021			
Greenberg Traurig LLP	Miami, FL	04/23/2021			
Grow Minds Consulting LLC	HOUSTON, TX	04/23/2021			
GT Educational Services (GT Educational Services, L.L.C.)	Houston, TX	04/23/2021			

GW Implementation Solutions	Nokomis, FL	04/23/2021			
H. J. DEBOER & ASSOCIATES	KINGWOOD, TX	04/23/2021			
Hagerty Consulting, Inc. (Freeman)	Evanston, IL	04/23/2021			
Hallmark Mitigation & Construction	Kingwood, TX	04/23/2021			
Happy Chapters, LLC	Austin, TX	04/23/2021			
Harmony Public Schools	Houston, TX	04/23/2021			
Harris County Houston Patrol, Inc.	Houston, TX	04/23/2021			
HARRIS-JONES STAFFING & RECRUITING	Katy, TX	04/23/2021			
Harvesting Wealth LLC	Houston, TX	04/23/2021			
Haude Tutoring	Spring, TX	04/23/2021			
Hayhouse Projects LLC	Brooklyn, NY	04/23/2021			
Hayley Wilson	Concord, NC	04/23/2021			
HCONE International IMPEX Inc (Enoch Kabutey)	Houston, PA	04/23/2021			
Healing Species of Texas	Montgomery, TX	04/23/2021			
Heart Nation Inc	Humble, TX	04/23/2021			
Heartwork Trending Counseling and Consulting, PLLC (Heartwork Trending Consulting Services)	Houston, TX	04/23/2021			
Heavenly Service, LLC	Webster, TX	04/23/2021			
Helping All Leaders Obtain Success (HALOS) (Helping All Leaders Obtain Success)	Homewood, IL	04/23/2021			
HENECO ENGINEERING AND CONSULTING	Houston, TX	04/23/2021			
Henry Deslaurier	Houston, TX	04/23/2021			
Hereford, Lynch, Sellars & Kirkham, P.C.	Cleveland, TX	04/23/2021			
Heritage Institute of Sustainability LLC	Dallas, TX	04/23/2021			
Herrera Talent Strategies LLC	Houston, TX	04/23/2021			
HillCo Partners, LLC	Austin, TX	04/23/2021			
HiMac Center for Creative Thinking	Humble, TX	04/23/2021			
HiTouch Business Services	LaVergne, TN	04/23/2021			
Hoensty Environmental Services	Houston, TX	04/23/2021	No Bid	04/29/2021	04/29/2021
Hogan's consulting (Deon I Hogan)	Pflugerville, TX	04/23/2021			
Holland Energy Consulting	Houston, TX	04/23/2021			
Holtz/Adams Construction and Consulting, LLC	Universal City, TX	04/23/2021			
Honesty Construction Group (HCG Management LLC)	Manvel, TX	04/23/2021			
Honor Moorman Consulting	Brazoria, TX	04/23/2021			
Hooper Strategies	Granbury, TX	04/23/2021			
Hope Over Hurt	Houston, TX	04/23/2021			
HORIZON SW PROPERTIES	SUGAR LAND, TX	04/23/2021			
Horn Solutions, Inc.	Sugar Land, TX	04/23/2021			
HORNE LLP	Austin, TX	04/23/2021			
Houston ISD - Medicaid Finance & Consulting Services	Houston, TX	04/23/2021			
Houston Modular Installation	Houston, TX	04/23/2021			
Houston Museum of Natural Science	Houston, TX	04/23/2021			
Houston Press, LP	Houston, TX	04/23/2021			
Houston Urban Debate League	Houston, TX	04/23/2021			
HR Best Practices (DIVA Solutions, LLC)	Franklin Lakes, NJ	04/23/2021			
HRchex, LLC (Intellisoft II, Inc.)	Irving, TX	04/23/2021			
HTEC-Houstons Training and Education Center, Inc. (Phillips)	Houston, TX	04/23/2021			
Hunt, Guillot & Associates	Baton Rouge, LA	04/23/2021			
Husch Blackwell LLP	Houston, TX	04/23/2021			
IA-Advanced Telecom Solutions, LLC	Richmond, TX	04/23/2021			
ICC Thermal Mapping and Data Analytcs (Infrared Concepts Corporation)	Maitland, FL	04/23/2021			
ID Media, Inc	Chicago, IL	04/23/2021			
IdentiFIE Special Education, LLC	Houston, TX	04/23/2021			
IECGTX (Insurance Estimating & Consulting Group, LLC)	SPRINGTOWN, TX	04/23/2021			
Imagine Excellence.Inc	Houston, TX	04/23/2021			
Imagine Me Academy	Crosby, TX	04/23/2021			
Imbue Cleaning Solutions	Augusta, GA	04/23/2021			
IMPACT 360	Missouri City, TX	04/23/2021			
Imperium Risk	Lubbock, TX	04/23/2021			
IMS Dodge	San Diego, CA	04/23/2021			
Indatatech (Instant Data Technologies, Inc.)	San Antonio, TX	04/23/2021			
Independent Financial	McKinney, TX	04/27/2021	Submitted	05/21/2021	05/21/2021

Infinite Education Solutions	Desoto, TX	04/23/2021		
Infinite Solutions Enterprises (The DDance Group, Inc.)	Glen Allen, VA	04/23/2021		
Infojini, Inc.	Columbia, MD	04/23/2021		
Ink International	Lawrenceville, GA	04/23/2021		
InnerChange Consulting Group	Houston, TX	04/23/2021		
Innovation Bridge, Inc.	Sacramento, CA	04/23/2021		
Innovative Texas Strategies LLC	Houston, TX	04/23/2021		
InnovsiteLLC	Decatur, GA	04/23/2021		
Insight Investments, LLC	Costa Mesa, CA	04/23/2021		
Instead	Kingwood, TX	04/23/2021		
Institute for Building Technology and Safety	VA, VA	04/23/2021		
Integrality (Integrality, LLC)	Dallas, TX	04/23/2021		
Integrity Operations	Katy, TX	04/23/2021		
Intellyk Inc	Piscataway, NJ	04/23/2021		
Interprise Software (Intrinity Incorporated)	Waterloo, ON	04/23/2021		
Interprise/Southwest Interior & Space Planning, Inc	Addison, TX	04/23/2021		
Invo Healthcare Associates (Invo Healthcare Associates, LLC)	Jamison, PA	04/23/2021		
IOS Acquisitions LLC	New York, NY	04/23/2021		
IPM Asset Solutions, Inc.	Houston, TX	04/23/2021		
IP Terra International Corporation	Houston, TX	04/23/2021		
I-Raos, Inc	Pearland, TX	04/23/2021		
Irving Hernandez	Austin, TX	04/23/2021		
ISE International Group	Bethesda, MD	04/23/2021		
ISES Corporation	Duluth, GA	04/23/2021		
Its Your Time To Flourish	Houston, TX	04/23/2021		
itsQuest, Inc.	Lubbock, TX	04/23/2021		
iWRITE (I Write)	Houston, TX	04/23/2021		
J Dorthen Martin, Speaker, Life Coach, Image Consultant	Houston, TX	04/23/2021		
Jackson Walker L.L.P.	Dallas, TX	04/23/2021		
JAGGAER	Morrisville, NC	04/23/2021		
Jaime Rios Financial Services Inc. (Money Concepts International Inc.)	Corpus Christi, TX	04/23/2021		
Janet Pozmantier, M.S., LPC, LMFT, RPT (Janet Pozmantier)	Houston, TX	04/23/2021		
JAVACCS, LLC	Humble, TX	04/23/2021		
JAVACCS, LLC and Johnson Second Chance - Vivian's Digital Learning Academy,LL	Houston, TX, TX	04/23/2021		
Javier Lopez	Houston, TX	04/23/2021		
JC Stonewall Constructors, LP	Houston, TX	04/23/2021		
Jean Polichino Consulting, LLC	Fredericksburg, TX	04/23/2021		
Jennifer Serravallo Consulting, LLC	South Orange, NJ	04/23/2021		
JER HR Group LLC	New York, NY	04/23/2021		
Jerry Gaither Enterprise	HOUSTON, TX	04/23/2021		
Jigsaw Learning LLC (TeachTown)	Woburn, MA	04/23/2021		
JLA Construction Solutions	Houston, TX	04/23/2021		
JLL (Jones Lang LaSalle, Americas, Inc.)	Houston, TX	04/23/2021		
JLL Valuation & Advisory Services, LLC	Houston, TX	04/23/2021		
Johnson Consulting (Adrian B. Johnson)	Houston, TX	04/23/2021		
Johnston, LLC	Houston, TX	04/23/2021		
Jon M. Warren, LLC	Decatur, TX	04/23/2021		
Jones Lang LaSalle (JLL)	Houston, TX	04/23/2021		
Jose Villarreal Consulting Services	Houston, TX	04/23/2021		
Journeys Managing Group LLC	Houston, TX	04/23/2021		
Joyce Davis/Erin Whitney	Houston, TX	04/23/2021		
JPMorgan	Houston, TX	04/23/2021	Submitted	05/21/2021 05/21/2021
JPMorgan Chase	Fort Worth, TX	04/23/2021		
JQ Infrastructure, LLC	Dallas, TX	04/23/2021		
JS&D Sports Development Outreach Ministries	Humble, TX	04/23/2021		
Jv-janitorial	Fortworth, TX	04/23/2021		
K Gab Assessments, Inc	Missouri City, TX	04/23/2021		
K&R Group, INC	Houston, TX	04/23/2021		
K12 Food Pros	La Mesa, CA	04/23/2021		
K12 Insight	Herndon, VA	04/23/2021		
K2 Consulting (K2 Construction Consultants, Inc.)	Bethsda, MD	04/23/2021		

KAEKA GROUP INC	Lacey, WA	04/23/2021		
Kagan Publishing & Professional Development	San Clemente, CA	04/23/2021		
KANKO (Floyd's Chores & Odd Jobs)	Dallas, TX	04/23/2021		
Karczewski Bradshaw, LLP	Nacogdoches, TX	04/23/2021		
KATTA INFOTEK INC	HOUSTON, TX	04/23/2021		
KCP Educational Consulting (Kristi Clarkson Pharaon)	Brenham, TX	04/23/2021		
Keey Group LLC	Rosharon, TX	04/23/2021		
Kennesaw State University iTeach (Elkins Pointe MS)	Kennesaw, GA	04/23/2021		
Keter Environmental Services	Indianapolis, IN	04/23/2021		
Keys to Literacy	Rowley, MA	04/23/2021		
KGBTexas Communications	Houston, TX	04/23/2021		
KH Literacy Education LLC (Kristen Leanne Henry)	San Antonio, TX	04/23/2021		
Kijo Consulting LLC	Houston, TX	04/23/2021		
Kinetic Potential Scholars (Digital Network Group)	Largo, MD	04/23/2021		
Kingham Dalton Wilson, Ltd.	Houston, TX	04/23/2021		
KLD PLAYSCAPES USA (TWO WORD COMPANY LLC)	Boca Raton, FL	04/23/2021		
KMD Hospitality (KMD Hospitality LLC)	Humble, TX	04/23/2021		
Konnecting the Dots	Houston, TX	04/23/2021	Viewed	05/12/2021
Kontrol Payables	Spokane, WA	04/23/2021		
Kriston Construction Company Inc	Beaumont, TX	04/23/2021		
KTM Educational Consulting, LLC	San Antonio, TX	04/23/2021		
L&S Associates, LLC	Montgomery, TX	04/23/2021		
L.SMURPHE.F Institute; Solutions by L.SMURPHE.F; L.SMURPHE.F Productions (L.SMURPHE.F Enterprises, Ltd. Co.)	League City, TX	04/23/2021		
La Capra Associates, Inc.	Boston, MA	04/23/2021		
Lady Liberty Group LLC	Eules, TX	04/23/2021		
Lan Nguyen	Houston, TX	04/23/2021		
Language Dynamics Group	Laramie, WY	04/23/2021		
Language Kids Houston, LLC	Sugar Land, TX	04/23/2021		
Lantana Communications	Arlington, TX	04/23/2021		
LaPorte CPAs and Busienss Advisors (LaPorte CPAs APAC)	Houston, TX	04/23/2021		
LATT Evaluations and Services, PLLC (La Shaun Arzu, PLLC)	Houston, TX	04/23/2021		
Launch Point CDC, Inc.	Houston, TX	04/23/2021	Unsubmitted	05/24/2021
LaVondia Menephee	Houston, TX	04/23/2021		
LBNM Corporation	Richmond, TX	04/23/2021		
Leading School Learning	Cypress, TX	04/23/2021		
Learning Omnivores (William Sommers)	Austin, TX	04/23/2021		
Lee Rutledge Consulting (Rutledge)	Austin, TX	04/23/2021		
Legends Do Live	Missouri City, TX	04/23/2021		
Leidos, Inc.	Maitland, FL	04/23/2021		
Levy's Tutorial and Enrichment Center (Mary Baumann)	Houston, TX		No Bid	05/04/2021 05/04/2021
Libra-Tech Corporation	Argyle, TX	04/23/2021		
Licensed To Solve (Dukes Global Works, INC)	CROSBY, TX	04/23/2021		
Lighthouse Groups LLC	Saint Louis, MO	04/23/2021		
Linder Consulting LLC	AUSTIN, TX	04/23/2021		
Liquid Studio Group	Laredo, TX	04/23/2021		
Lisa K Bailey	Missouri City, TX	04/23/2021		
Live Green Teams (CALPAA, Inc)	Seattle, WA	04/23/2021		
Logyx	Mountain View, CA	04/23/2021		
Lone Star Security Shield, Inc.	Houston, TX	04/23/2021		
Look to Success, LLC (Michelle Lee Pina)	Houston, TX	04/23/2021		
Love 2 the Max	Houston, TX	04/23/2021		
Lovescaping LLC	Houston, TX	04/23/2021		
Lowes Companies Inc	Mooresville, NC	04/23/2021		
LQI Consulting Group, LLC	Round Rock, TX	04/23/2021		
L-Sync, LLC	Grand Prairie, TX	04/23/2021		
Lucy Anderson	Houston, TX	04/23/2021		
Lurie, Ilp	Minneapolis, MN	04/23/2021		
Lynn Gomes, LLC (Lynn Gomes)	Houston, TX	04/23/2021		



M&H Lighting Systems (Mapenzi Group)	Pearland, TX	04/23/2021			
M.E.N. (Mentoring, Educating & Nurturing)	Houston, TX	04/23/2021	No Bid	05/07/2021	05/07/2021
Incorporated (MEN Inc.)					
M3 Inc	Brooklyn, NY	04/23/2021			
Main Stop Testing Svcs	Houston, TX	04/23/2021			
Majestic Transportation	Pearland, TX	04/23/2021			
Maker Maven	Tomball, TX	04/23/2021			
Makr U	Spring, TX	04/23/2021			
Malor & Company Inc	New York, NY	04/23/2021			
Marathon Partners Consulting	Moon Township, PA	04/23/2021			
Marathon Staffing Group, Inc.	Tyngsboro, MA	04/23/2021			
Mark Collins Construction LLC	League City, TX	04/23/2021			
Mark J. Rogers	Austin, TX	04/23/2021			
Mark Matranga	Fort Worth, TX	04/23/2021			
Marketing Addiction Inc.	Houston, TX	04/23/2021			
Marseal Group	Roanoke, TX	04/23/2021			
Mary Benton Communications and Public Affairs	Houston, TX	04/23/2021			
MAS Solutions LLC.	Fulshear, TX	04/23/2021			
Math-A-Matics Tutoring,LLC	Houston, TX	04/23/2021			
Maxim Healthcare Staffing Services, Inc.	San Luis Obispo, CA	04/23/2021			
MAXIMUS	Reston, VA	04/23/2021			
MCA Communications	Houston, TX	04/23/2021			
McConnell & Jones LLP	Houston, TX	04/23/2021			
McKinstry (McKinstry Essention, Inc.)	Dallas, TX	04/23/2021			
MCP Professional Services (Dr. Deloris L. Nelson)	Houston, TX	04/23/2021			
MedHelp, Inc.	Baltimore, MD	04/23/2021			
Mediators of Texas (Austin Texas Mediators LLC)	Florence, TX	04/23/2021			
Medicaid Claim Solutions of Texas, Inc.	Mansfield, TX	04/23/2021			
Melba Figueroa (HonestRx Consulting LLC)	Southlake, TX	04/23/2021			
Melton & Melton, LLP	Houston, TX	04/23/2021			
MERCER TECHNOLOGIES FIRM	Gary, IN	04/23/2021			
Metamorphosis Concepts	Manvel, TX	04/23/2021			
Meveau (Mercedes Watkins)	Houston, TX	04/23/2021			
Michael Best Strategies	Madison, WI	04/23/2021			
Microburst Learning, LLC	Columbia, SC	04/23/2021			
Mills Systems Solutions, LLC	Farmers Branch, TX	04/23/2021			
Millunzi & Associates	The Woodlands, TX	04/23/2021			
Minding YOB Services, LLC	Arlington, TX	04/23/2021			
Mitaja Corporation	Fulton, MD	04/23/2021			
Mixxdd Marketing	Kenedy, TX	04/23/2021			
MJR EDUCATIONAL SUPPLIES	Houston, TX	04/23/2021			
ML Deer Construction	Houston, TX	04/23/2021			
MMG Consulting Partners (Maryland Grier-Union)	Houston, TX	04/23/2021			
MNB Services	Houston, TX	04/23/2021			
Mobile Collegiate	Dallas, TX	04/23/2021			
Modified Logic	Prosper, TX	04/23/2021			
Monica Lewis School of Etiquette	Spring, TX	04/23/2021			
Moody National Bank	Galveston, TX	04/27/2021			
Moore Counseling and Psychological Services (Lorenzo Moore)	Houston, TX	04/23/2021			
Mosley School of Oratory	Houston, TX	04/23/2021			
MPACT STRATEGIC CONSULTING, LLC	Houston, TX	04/23/2021			
MSB Consulting LLC	Austin, TX	04/23/2021			
MSys inc	washington, DC	04/23/2021			
MVHL Consulting, LLC	San Antonio, TX	04/23/2021			
Namitzi Yoga (Mitzi Henderson)	HOUSTON, TX	04/23/2021			
Nasare Enterprises,LLC.	Houston, TX	04/23/2021			
National Energy Solutions	Houston, TX	04/23/2021			
NationSync (NationSync Corporation)	Houston, TX	04/23/2021			
Nazca Technologies and Consulting LLC	MONTGOMERY, TX	04/23/2021			
NEDRP, LLC (RD360 EDUCATIONAL CONSULTING)	Canyon Lake, TX	04/23/2021			
NERDY BIRDIE (ENOVATEKK)	SPRING, TX	04/23/2021			
New Spectrum Educational Consultants (Civil Society Educational Consultants)	Houston, TX	04/23/2021			
New Teacher Center	Santa Cruz, CA	04/23/2021			

Newspring	Houston, TX	04/23/2021		
Nichelle Pinkney, The Urban Scholar, Independent Consultant (Nichelle Pinkney) no bully here	Houston, TX	04/23/2021		
NO EGO APPAREL (NO EGO INC)	PASADENA, TX	04/23/2021		
NuHealth, Inc.	AUSTIN, TX	04/23/2021		
NURSES Etc STAFFING (Donald L Mooney Enterprises, LLC)	Houston, TX	04/23/2021		
Nurture to Blossom Services, Inc.	Houston, TX	04/23/2021		
Nuvalo LLC	Gig Harbor, WA	04/23/2021		
Nylinka School Solutions	Kensington, MD	04/23/2021		
Oak Hill Technology, Inc.	Driftwood, TX	04/23/2021		
Odigo Services LLC	Houston, TX	04/23/2021		
O'Hanlon, Demerath & Castillo	Austin, TX	04/23/2021		
Olivier, Inc.	Dallas, TX	04/23/2021		
Omega Engineers, Inc.	Houston, TX	04/23/2021		
Ondi Love Center Ministries	Houston, TX	04/23/2021		
One Source International, LLC	Houston, TX	04/23/2021		
One Way Education, LLC	Houston, TX	04/23/2021		
Operations Contracting Agency LLC	Schertz, TX	04/23/2021		
Optima Train (Delwar Enterprises LLC)	Houston, TX	04/23/2021		
Optimum Lifestyle CDC (www.olcdonline.org)	Houston, TX	04/23/2021		
Orrick, Herrington & Sutcliffe LLP	Houston, TX	04/23/2021	Viewed	05/12/2021
Own the Room Communication Coaching & Consulting (Rukiya M. Akua)	Houston, TX	04/23/2021		
Ozeal Consulting Group (Oziel Enriquez)	Sugar Land, TX	04/23/2021		
P Eugene Turner	Waller, TX	04/23/2021		
Padgett, Stratemann & Co., L.L.P.	San Antonio, TX	04/23/2021		
Pangea Biological (Okapi Environmental Group, Inc.)	Carlsbad, CA	04/23/2021		
Panorama Education	Boston, MA	04/23/2021		
Parker and Jamison LLC	Irving, TX	04/23/2021		
Patricia Monticello Kievlan (Patricia Marie Kievlan)	The Woodlands, TX	04/23/2021		
PAUL J. COSELLI, ATTORNEY AT LAW	BELLAIRE, TX	04/23/2021		
Payton, Nix & Associates, LLC	LUCAS, TX	04/23/2021		
Pcubed (Program Planning Professionals)	Ann Arbor, MI	04/23/2021		
Penelton Consulting Services, LLC	Houston, TX	04/23/2021		
Personal Touch Therapy (Shontai Thomas)	Houston, TX	04/23/2021		
Personnel Evaluation, Inc.	Milwaukee, WI	04/23/2021		
PESG of Texas	Houston, TX	04/23/2021		
PEX (Prepaid Expense Card Solutions, Inc)	New York, NY	04/23/2021		
PHD Resources & Taxes	Houston, TX	04/23/2021		
Phillip (Barker)	Houston, TX	04/23/2021		
Pinnacle Workforce Strategies	Tucson, AZ	04/23/2021		
Piper Sandler & Co.	Houston, TX	04/23/2021		
Pittman Training (Vision Educational Solutions)	Dallas, TX	04/23/2021		
PlainsCapital Bank	Pharr, TX	04/27/2021	Submitted	05/25/2021 05/25/2021
Plante & Moran, PLLC	Southfield, MI	04/23/2021		
Plexos Group LLC	Baton Rouge, LA	04/23/2021		
Point Alliance Solutions	Spring, TX	04/23/2021		
Porter Brown Associates	Alachua, FL	04/23/2021		
Positive Behavior Supports Corp	IRVING, TX	04/23/2021		
Postlethwaite & Netterville APAC (Lacher)	Baton Rouge, LA	04/23/2021		
Powell-Leon, LLP	Austin, TX	04/23/2021		
Power Institute LLC	Missouri City, TX	04/23/2021		
Power of Choosing Inc.	Texas, TX	04/23/2021		
Practical Parent Education	Mckinney, TX	04/23/2021		
Precision Medical Billing (PMB Precision Medical Billing, Inc.)	Houston, TX	04/23/2021		
Premier Employee Solutions	Provo, UT	04/23/2021		
Premier Staffing Source, Inc.	Lanham, MD	04/23/2021		
Premiere Speakers Bureau	Franklin, TN	04/23/2021		
Presidential Staffing Solutions	San Antonio, TX	04/23/2021		
Price Consulting, Inc.	Houston, TX	04/23/2021		
Prime Sanitizing	Mckinney, TX	04/23/2021		
Proactive Thought Leaders, LLC	Arlington, TX	04/23/2021		

ProBizAssoc.com (Beth Philley)	Canton, OH	04/23/2021			
Probolsky Research	Newport Beach, CA	04/23/2021			
PROCEDEO	Fort Worth, TX	04/23/2021			
Prodigi, LLC	Lewes, DE	04/23/2021			
Productive Ventures	Spring, TX	04/23/2021			
Professional Credit Service (Ray Klein Inc)	Vancouver, WA	04/23/2021			
Projects-Matter (Projects-Matter LLC)	Houston, TX	04/23/2021			
Promos On-Time	New York, NY	04/23/2021			
Pronto Shipping and Packaging Services Inc.	Houston, TX	04/23/2021			
PROTECHT Management Group, LLC	Austin, TX	04/23/2021			
Protection Engineering Consultants LLC	Austin, TX	04/23/2021			
Protiviti	Houston, TX	04/23/2021			
PSST, LLC (PSST Acquisition, LLC)	Louisville, KY	04/23/2021			
PST Services, Inc., a McKesson company (PST Services, Inc.)	Alpharetta, GA	04/23/2021			
Public Works LLC	West Chester, PA	04/23/2021			
PuckettPro (PuckettPro Inc)	TX, TX	04/23/2021			
Purposeful Parents	Webster, TX	04/23/2021			
PVH Consulting Group LLC	Austin, TX	04/23/2021			
PVMA, LLC (Project & Vendor Management Advisors, LLC)	Houston, TX	04/23/2021			
Quintero Enterprises (Zoom Technologies LLC)	Ridgewood, NY	04/23/2021			
Rachel Brownlie	Houston, TX	04/23/2021			
Ramos & Harrison	Corpus Christi, TX	04/23/2021			
Randles & Associates, LLC	Corpus Christi, TX	04/23/2021			
RDI Global Services	El Paso, TX	04/23/2021			
RDI Mechanical	Houston, TX	04/23/2021			
Real Good Technologies	Austin, TX	04/23/2021			
Recruiting In Motion	Orlando, FL	04/23/2021			
Recruiting Source International	Katy, TX	04/23/2021			
Reflective Energy Solutions	Hackensack, NJ	04/23/2021			
Refrigeration Technologies, LLC	Pottstown, PA		No Bid	05/06/2021	05/06/2021
Region One Education Service Center	Edinburg, TX	04/23/2021			
Reliable R&R Training Services	Dallas, TX	04/23/2021			
Reliant Elevators (Reliant Elevators, LLC)	Joshua, TX	04/23/2021			
Relocation Strategies (Luo & Chang Investment LLC)	houston, TX	04/23/2021			
Remember When Kids Were Kids (Jaelijah)	Spring, TX	04/23/2021			
Remy Dillenseger	Houston, TX	04/23/2021			
Resolute Educational Solutions, L.L.C.	Detroit, MI	04/23/2021			
Responsive Learning (Responsive Learning, LP)	El Paso, TX	04/23/2021			
RG Guillory Education & Consulting, LLC	Houston, TX	04/23/2021			
Rice & Associates, PC	Houston, TX	04/23/2021			
Richards/Carlberg (Richards Carlberg, Inc.)	Houston, TX	04/23/2021			
Ricoh USA	Houston, TX	04/23/2021			
Rising Star Academy	Houston, TX	04/23/2021			
Rivera-Vega Group, LLC.	San Antonio, TX	04/23/2021			
RND Technology	Houston, TX	04/23/2021			
Roberts Enterprise	Houston, TX	04/23/2021			
Rogers, Morris & Grover, LLP	Houston, TX	04/23/2021			
Roland Gonzales	Spring, TX	04/23/2021			
RR CONNECTION CONSULTING	Duncanville, TX	04/23/2021			
Rukaz Kultura	HOUSTON, TX	04/23/2021			
S Corporation	Phila, PA	04/23/2021			
s3strategies	Lubbock, TX	04/23/2021			
Sabari Tech Solutions LLC	Richmond, TX	04/23/2021			
SAMCO Capital Markets, Inc.	San Antonio, TX	04/23/2021			
Sanders Services (Richard Sanders)	Morrow, GA	04/23/2021			
Santos Alliances	Austin, TX	04/23/2021			
SBC Consulting (Tammy Smithers)	Houston, TX	04/23/2021			
SBL Solutions (Strategic Business Life Solutions)	Rosharon, TX	04/23/2021			
SBLM Architects	New York, NY	04/23/2021			
SCG Business Services, LLC	Douglasville, GA	04/23/2021			
School Food Service Innovations	Jourdanton, TX	04/23/2021			
Schulman, Lopez, Hoffer & Adelstein	Houston, TX	04/23/2021			
Schultz Center for Teaching and Leadership, Inc.	Jacksonville, FL	04/23/2021			
Science Unlimited, LLC	Missouri City, TX	04/23/2021			

Second Chance Learning Center	Houston, TX	04/23/2021			
Second Chance Technology Edge High School	Houston, TX	04/23/2021			
ServiceMaster Recovery Management (Service Environments of Texas, Inc.)	Kingwood, TX	04/23/2021			
Session Tax Consulting & Grant Writing (Session Tax Consulting and grant writing)	HOUSTON, TX	04/23/2021			
Shaneka Smith	Houston, TX	04/23/2021			
Sharron Helmke	Dickinson, TX	04/23/2021			
Shepherd Government Services Group (SGSG, LLC)	Carrollton, TX	04/23/2021			
Shine Bright Tutoring (LPOH, LLC)	Pearland, TX	04/23/2021			
Sierra Consulting, Inc	Itasca, IL	04/23/2021			
Sigga Workforce Technologies	Sugar Land, TX	04/23/2021			
Sigma Consulting Corp.	Metairie, LA	04/23/2021			
Sign Advisors (Cost Advisors of Texas, LLC)	Houston, TX	04/23/2021			
SilkWeb Consulting and Development, LLC	Scottsdale, AZ	04/23/2021			
SimiDigi Inc	Garland, TX	04/23/2021			
Sketch City	Houston, TX	04/23/2021			
Sky's the Limit	Houston, TX	04/23/2021			
SL King and Associates	Atlanta, GA	04/23/2021			
Slalom (Slalom LLC)	Houston, TX	04/23/2021			
SLL Services, LLC	Palestine, TX	04/23/2021			
Smart Scholars Foundation	Houston, TX	04/23/2021			
Smarter HR Solutions	Houston, TX	04/23/2021			
SMARTOX	Irving, TX	04/23/2021			
SMRT Solutions (SMRT Consulting LLC)	Washington DC, DC	04/23/2021			
SnapTemps Staffing, ProFinal Clean, ExactScreen, SafeSource (Affinity Professional Group, LLC.)	Houston, TX	04/23/2021			
SOA Fin1st	Pearland, TX	04/23/2021			
Social Motion, Inc.	Houston, TX	04/23/2021			
Social Studies Success	Spring, TX	04/23/2021			
Soffline International USA, Inc	Miami, FL	04/23/2021			
Solel International	Houston, TX	04/23/2021			
Solix Inc. dba Sivic Solutions (Sivic Solutions Group LLC)	Parsippany, NJ	04/23/2021			
south texas boiler	houston, TX	04/23/2021			
South Texas Counseling and Mentoring : Adult Education	Houston, TX	04/23/2021			
Southeast Technical Solutions	League City, TX	04/23/2021			
Southwest Glen Mission	Houston, TX	04/23/2021			
SPDF KIDS	Houston, TX	04/23/2021			
Special Evaluations & Consulting of Texas	Dallas, TX	04/23/2021			
Springsted Human Capital Advisors	St. Paul, MN	04/23/2021			
Spur Employment, Inc.	HUNTSVILLE, AL	04/23/2021			
SPZ GLOBAL ENERGY LLC	north bergen, NJ	04/23/2021			
SSCI Environmental (Separation Systems Consultants, Inc.)	Houston, TX	04/23/2021			
SSG-MUSIC	LAS VEGAS, NV	04/23/2021			
Staff Hunt LLC	Houston, TX	04/23/2021			
STAFF TODAY INC (STI)	COVINA, CA	04/23/2021			
Staffmark (Staffmark Investment LLC)	Cincinnati, OH	04/23/2021	No Bid	05/05/2021	05/05/2021
Standard Morgan Partners, LTD	Houston, TX	04/23/2021			
Steam Kidstitude (Insight Community Resources Inc)	Houston, TX	04/23/2021			
STEM Urban Perspective (Science, Technology, Engineering with an Urban Perspective)	Humble, TX	04/23/2021			
Sterling Empowerment	HOUSTON, TX	04/23/2021			
Sterling Staffing Solutions (Maceo Carter Investments, LLC)	Sugar Land, TX	04/23/2021			
Sterling Therapy & Rehabilitation	SUGAR LAND, TX	04/23/2021			
Stetson & Associates, Inc.	Houston, TX	04/23/2021			
Steve Spangler Inc.	Littleton, CO	04/23/2021			
Stevenson Workshop and Seminar Solutions	league city, TX	04/23/2021			
Stifel, Nicolaus & Company, Inc.	Houston, TX	04/23/2021			
Stone Oak Solutions, LLC	New Braunfels, TX	04/23/2021			
Storytelli' Time (MARY JO HUFF)	NEWBURGH, IN	04/23/2021			

Strahan Cain, PLLC	Houston, TX	04/23/2021			
Straight Defined	Copperas Cove, TX	04/23/2021			
Straight Line Management (Straight Line Management LLC)	San Antonio, TX	04/23/2021			
Strategar (Strategar LLC)	Addison, TX	04/23/2021			
Strategic Partnerships, Inc.	Austin, TX	04/23/2021			
Strategic Solutions Group	Needham, MA	04/23/2021			
STRAUS SYSTEMS INC	STAFFORD, TX	04/23/2021			
Streamline Health Services	San Juan Capistrano, CA	04/23/2021			
Students of Strength, Inc.	Cambridge, MA	04/23/2021			
Successful Starters Learning Academy II	Houston, TX	04/23/2021			
Supporting Educators Daily	Missouri City, TX	04/23/2021			
Susan M. Catlett, Ph.D., BCBA-D	Houston, TX	04/23/2021			
SWA International Company	Houston, TX	04/23/2021			
T.E.B Benefits Group Inc	El Paso, TX	04/23/2021			
Table SALT Group	Houston, TX	04/23/2021			
TalentStaff	Spring, TX	04/23/2021			
Tammy Rodney	Houston, TX	04/23/2021			
Tandi Oil and Gas LLC	KATY, TX	04/23/2021			
TCT Enterprises, LLC	Houston, TX	04/23/2021			
Teach2Learn (Elliott and McMahon)	Friendswood, TX	04/23/2021			
Teaching Strategies, LLC	Bethesda, MD	04/23/2021			
Team Driven Technology Inc.	Fort Worth, TX	04/23/2021			
TeamLogic IT (Philoxenus, Inc.)	Houston, TX	04/23/2021			
TEC Sales	college station, TX	04/23/2021			
Tecnics Consulting, Inc.	Houston, TX	04/23/2021			
TEEN TRUTH (TEEN TRUTH, LLC)	DRIPPING SPRINGS, TX	04/23/2021			
Tekgration LLC	San Antonio, TX	04/23/2021			
Tetra Tech, Inc.	Maitland, FL	04/23/2021			
Texan-French Alliance for the Arts	Houston, TX	04/23/2021			
Texans Together Education Fund Inc	Houston, TX	04/23/2021			
Texas Association of African American Chambers of Commerce (TAAACC)	Austin, TX	04/23/2021			
Texas Educational Consultative Services, Inc.	Austin, TX	04/23/2021			
Texas Gulf Bank N.A.	Houston, TX	04/27/2021	Submitted	05/20/2021	05/20/2021
Texas Initiative Programs (The K16 Ready Society, Inc.)	Fort Worth, TX	04/23/2021			
Texas STAAR Publishing, LLC	Sugarland, TX	04/23/2021			
Texas State Billing Services Inc	Kyle, TX	04/23/2021			
TexConnect Communications, LLC	Brazoria, TX	04/23/2021			
The Afterschool Professional	Pflugerville, TX	04/23/2021			
The A-List Network, LLC (Stephanie Belton)	Rosharon, TX	04/23/2021			
The Bob Pike Group	Bloomington, MN	04/23/2021			
The Box Program (Box Program)	Baytown, TX	04/23/2021			
The Business Concierge (Goodwill Houston)	Houston, TX	04/23/2021			
The Carmona Firm, PLLC	Houston, TX	04/23/2021			
The Christopher Quinn Group Inc.	Dallas, TX	04/23/2021			
The Class Ring Company	McAllen, TX	04/23/2021			
The CNA Corporation (CNA)	Arlington, VA	04/23/2021			
The Danielson Group	Chicago, IL	04/23/2021			
The Donatto Group	Houston, TX	04/23/2021			
The E2 Group, Inc.	Sugar Land, TX	04/23/2021			
The Educator Collaborative	Astoria, NY	04/23/2021			
The Fulton Law Group PLLC	Houston, TX	04/23/2021			
The Green Alliance	Katy, TX	04/23/2021			
The Hanover Research Council, LLC	Arlington, VA	04/23/2021			
The Harris Foundation	Houston, TX	04/23/2021			
The Healthy School Food Collaborative	New Orleans, LA	04/23/2021			
The Heart of God Restoration Ministry	Houston, TX	04/23/2021			
The K.N.E.W. Solutions (Keschia Matthews)	FRESNO, TX	04/23/2021			
The Kadence Collective, LLC	San Antonio, TX	04/23/2021			
The KD Company (Kim Y. Davis Enterprises, LLC)	Houston, TX	04/23/2021			
The King & Associates Firm	Brazoria, TX	04/23/2021			
The Knowledge Stack (The Knowledge Stack LLC)	Los Angeles, CA	04/23/2021			
The Kovacs Group	New Braunfels, TX	04/23/2021			

The MINT National Bank	Kingwood, TX	04/23/2021			
The National Behavioral Intervention Team Association	King of Prussia, PA	04/23/2021			
The Ombudsmen Group	Cibolo, TX	04/23/2021			
The Outreach Program Education/Counseling Services	Houston, TX	04/23/2021			
The Paper Plate, Inc	Dallas, TX	04/23/2021			
The Parent Coach	HOUSTON, TX	04/23/2021			
The Platform	Houston, TX	04/23/2021			
The Process Manager (Meliton Moya, Ph.D.)	Edinburg, TX	04/23/2021			
The Resilient Group	Houston, TX	04/23/2021			
The Schlueter Group (Stan Schlueter)	Austin, TX	04/23/2021			
The Style Signature	Carrollton, TX	04/23/2021			
The TEAMS Group, LLC	Austin, TX	04/23/2021			
The Trade Group	Carrollton, TX	04/23/2021			
The Yates Company	Houston, TX	04/23/2021			
TheDataFyles	Bellaire, TX	04/23/2021			
Therapy Consultants (MedPerm Placement Inc)	Houston, TX	04/23/2021			
Theresa Harris	HOUSTON, TX	04/23/2021			
thinkLaw (CS Educational Services, LLC)	Las Vegas, NV	04/23/2021			
Thomas Educational Solutions	Pearland, TX	04/23/2021	No Bid	04/23/2021	04/23/2021
Thompson & Horton LLP	Houston, TX	04/23/2021			
Thompson Educational Consulting, Inc.	Missouri City, TX	04/23/2021			
Tier One Learning, LLC	Sugar Land, TX	04/23/2021	Viewed	05/11/2021	
Timothy Project: Youth Mentoring Youth, Inc.	Houston, TX	04/23/2021			
TinMan Enterprises (TX TinMan Enterprises, LLC)	Fort Worth, TX	04/23/2021			
Tiphany Chambers Burrell	HOUSTON, TX	04/23/2021			
TISOMO Consulting Group, LLC	Jacksonville, FL	04/23/2021			
TITAN School Solutions, Inc.	Irvine, CA	04/23/2021			
TLE Inc (The Look Enterprises, Inc.)	Bellaire, TX	04/23/2021			
TMB Screen Printing & Embroidery Spring	Spring, TX	04/23/2021			
TMI Solutions, LLC	George West, TX	04/23/2021			
TNCPA	Houston, TX	04/23/2021			
TNR Accounting & Management Consulting, LLC (Nannette Ray)	Katy, TX	04/23/2021			
TNTP (The New Teacher Project, Inc.)	Brooklyn, NY	04/23/2021			
Tomorrow N Training	Houston, TX	04/23/2021			
Total Administrative Services Corporation	Madsion, WI	04/23/2021			
Total Special Education Solutions, LLC	Beaumont, TX	04/23/2021			
TPR Education LLC (The Princeton Review)	Natick, MA	04/23/2021			
Trace3, Inc.	Irvine, CA	04/23/2021			
Transaption	Wilmington, DE	04/23/2021			
Transcare llc	Houston, TX	04/23/2021			
Transformation7 by Tiffany A. Washington	Houston, TX	04/23/2021			
Translation & Interpretation Network (Catholic Charities Diocese of Fort Worth, Inc. d/b/a Translation & Interpretation Network)	Fort Worth, TX	04/23/2021			
TransLinguist Translation & Document Clearing LLC	Dubai,	04/23/2021			
Trezvant Academy, Inc	Houston, TX	04/23/2021			
Trinity Review Services Inc	Houston, TX	04/23/2021			
True Love Childcare	Humble, TX	04/23/2021			
Trustmark National Bank	Jackson, MS	04/23/2021			
TSC COGIC	houston, TX	04/23/2021			
TSG Industries (The Sithe Group, LLC.)	Houston, TX	04/23/2021			
Tutor Doctor	Navasota, TX	04/23/2021			
Tynker	Mountain View, CA	04/23/2021			
U. S. WHOLESALE PRODUCTS	SAN ANTONIO, TX	04/23/2021			
U.S. Dream Academy, Inc	Columbia, PA	04/23/2021			
U-Bridge Project Consulting, LLC	Sugarland, TX	04/23/2021			
UNICOM Government, Inc. F/K/A GTSI Corp.	Chantilly, VA	04/23/2021	Viewed	05/12/2021	
Unified Sunergy Systems LLC	Flower Mound, TX	04/23/2021			
Unity National Bank of Houston	Houston, TX		Viewed	05/11/2021	
Unlimited Visions Aftercare, Inc	Houston, TX	04/23/2021			
UNTAPPED Genius	Missouri City, TX	04/23/2021			
UP Educational Consulting	Conroe, TX	04/23/2021			
US Executive LLC	Tampa, FL	04/23/2021			

USG Staffing LLC	Humble, TX	04/23/2021		
Utturn Concepts Inc	Houston, TX	04/23/2021		
Vanguard Trading & Services, LLC	Houston, TX	04/23/2021		
VantagePoint Benefits (J. Peat & Associates)	Lynbrook, NY	04/23/2021		
Velvet Rope Experience (VRE Business Soultions)	Houston, TX	04/23/2021		
Victory Group	Houston, TX	04/23/2021		
Vinnove Consulting Group	San Antonio, TX	04/23/2021		
Virtuo Group Corporation	The Woodlands, TX	04/23/2021		
Visual Communication Services (Webbco Enterprises, LLC)	Houston, TX	04/23/2021		
Volition IIT Inc	ASHBURN, VA	04/23/2021		
VOX Global	Dallas, TX	04/23/2021		
VRJ & Associates, LLC	Sugar Land, TX	04/23/2021		
vTech Solution Inc.	Washington, DC	04/23/2021		
W.J. Alexander & Associates, P.C.	Houston, TX	04/23/2021		
Waits Consulting Group	Houston, TX	04/23/2021		
Walk the Walk Promotions	Richardson, TX	04/23/2021		
Walker Quality Services	Cypress, TX	04/23/2021		
Walsh Gallegos Treviño Russo & Kyle P.C.	Austin, TX	04/23/2021		
WaterLily Writing, LLC	Arlington, TX	04/23/2021		
Watkins & Associates Consulting Services LLC.	Houston, TX	04/23/2021		
Weaver	Houston, TX	04/23/2021		
Weaver and Tidwell, LLP	Houston, TX	04/23/2021		
Weber Services	Montgomery, TX	04/23/2021		
Wellesley College	Wellesley, MA	04/23/2021		
Wells Fargo Bank NA	Minneapolis, MN	04/23/2021		
Wells Fargo Bank. NA	Houston, TX	04/23/2021		
Wellspring Family & Community Institute	Houston, TX	04/23/2021		
Wendy Perry Coparenting Education (www.wendyjerry.com)	Watauga, TX	04/23/2021		
Westat	San Antonio, TX	04/23/2021		
Whiltey Penn	Houston, TX	04/23/2021		
Whitley Penn, LLP	Houston, TX	04/23/2021		
Willdan Engineering	Anaheim, CA	04/23/2021		
Williams Education Consulting	Houston, TX	04/23/2021		
Williams Technical Staffing	Sugar Land, TX	04/23/2021		
Workshop Houston	Houston, TX	04/23/2021		
Wright One Training	Flower Mound, TX	04/23/2021		
Writers in the Schools	Houston, TX	04/23/2021		
Writing with Design (The Learning Project)	Norman, OK	04/23/2021		
WRM Development	Selma, TX	04/23/2021		
Wylie Construction Services	Humble, TX	04/23/2021	Viewed	05/13/2021
xtremetees embroidery and printing	San Juan, TX	04/23/2021		
Yolah - Yolandra Drake	Houston, TX	04/23/2021		
Young Women Christian Association of Houston	Houston, TX	04/23/2021		
Your Business Solutions (Distinguished Network Engenuity, Inc.)	The Woodlands, TX	04/23/2021		
Your Pro Medical Inc. (Your Pro Consultant Inc.)	Bedford, TX	04/23/2021		
Youth Advocacy TEAM	Houston, TX	04/23/2021		
Youth Debate League (MDG Gulf Coast, LLC)	Missouri City, TX	04/23/2021		
Z Smart, LLC	Rockwall, TX	04/23/2021		
Zen Insurance Services, LLC	Austin, TX	04/23/2021		
Zenith Designs, LLC	Houston, TX	04/23/2021		
ZNA DESIGN (ZNA GROUP LLC)	Katy, TX	04/23/2021		
ZolonTech, Inc.	Herndon, VA	04/23/2021		

## External Invitations

Invite Email	Auto Approve	Invitation Date	Status	Status Date
afutrell@origin.bank	No	04/27/2021	Invitation Sent	04/27/2021
Alan.Villanueva@hancockwhitney.com	No	04/27/2021	Invitation Sent	04/27/2021
Amy.Wills@cadencebank.com	No	04/27/2021	Approved	04/28/2021
angela.tellez@amegybank.com	No	04/27/2021	Invitation Sent	04/27/2021
annesa.brewer@ozk.com	No	04/27/2021	Invitation Sent	04/27/2021
anthony.Justice@bbva.com	No	04/27/2021	Invitation Sent	04/27/2021

barnard.o.woodruff@bofa.com	No	04/27/2021	Invitation Sent	04/27/2021
bwhitlock@bankoftexas.com	No	04/27/2021	Invitation Sent	04/27/2021
cassandra.wiggins@bxs.com	No	04/27/2021	Invitation Sent	04/27/2021
CFloyd@cbotx.com	No	04/27/2021	Invitation Sent	04/27/2021
Corey.Huston@pnc.com	No	04/27/2021	Invitation Sent	04/27/2021
cpayne@gnty.com	No	04/27/2021	Invitation Sent	04/27/2021
Cpuccinelli@tcbsb.com	No	04/27/2021	Invitation Sent	04/27/2021
cwentzler@woodforest.com	No	04/27/2021	Invitation Sent	04/27/2021
DebbieLozano@ibc.com	No	04/27/2021	Invitation Sent	04/27/2021
Drew.Harper@ozk.com	No	04/27/2021	Invitation Sent	04/27/2021
Esau.Liu@eastwestbank.com	No	04/27/2021	Invitation Sent	04/27/2021
Ginger.Johnson@prosperitybankusa.com	No	04/27/2021	Invitation Sent	04/27/2021
Jeff.Nuckols@frostbank.com	No	04/27/2021	Invitation Sent	04/27/2021
jennifer.lavender@hancockwhitney.com	No	04/27/2021	Invitation Sent	04/27/2021
Jenny.Taylor@texanbank.com	No	04/27/2021	Invitation Sent	04/27/2021
Jessica.Pelache@1stnb.com	No	04/27/2021	Invitation Sent	04/27/2021
Jmoss@tcbsb.com	No	04/27/2021	Invitation Sent	04/27/2021
John.Taylor@texascapitalbank.com	No	04/27/2021	Invitation Sent	04/27/2021
Liz.Webb@texasfirst.bank	No	04/27/2021	Invitation Sent	04/27/2021
Merrill.Wautlet@regions.com	No	04/27/2021	Invitation Sent	04/27/2021
mfoster@moodybank.com	No	04/27/2021	Approved	04/27/2021
mhenson@texasgulfbank.com	No	04/27/2021	Approved	05/03/2021
Michael.Bradford@regions.com	No	04/27/2021	Invitation Sent	04/27/2021
Michelle.Valencia@allegiancebank.com	No	04/27/2021	Invitation Sent	04/27/2021
Mike.Weir@amegybank.com	No	04/27/2021	Invitation Sent	04/27/2021
nathan.hutson@bofa.com	No	04/27/2021	Invitation Sent	04/27/2021
Nbranch@gnty.com	No	04/27/2021	Invitation Sent	04/27/2021
Nelrod@jibt.com	No	04/27/2021	Approved	04/28/2021
nmirabal@BBandT.com	No	04/27/2021	Invitation Sent	04/27/2021
orlando.a.saenz@wellsfargo.com	No	04/27/2021	Invitation Sent	04/27/2021
patty.fougerat@texascapitalbank.com	No	04/27/2021	Invitation Sent	04/27/2021
Paul.Tyler@texasfirst.bank	No	04/27/2021	Invitation Sent	04/27/2021
PGlasson@city.bank	No	04/27/2021	Invitation Sent	04/27/2021
QHolmesSmith@trustmark.com	No	04/27/2021	Invitation Sent	04/27/2021
R.Michael.Erskine@BBandT.com	No	04/27/2021	Invitation Sent	04/27/2021
Roger.Sebesta@wallisbank.com	No	04/27/2021	Invitation Sent	04/27/2021
roxanna.deleon@plainscapital.com	No	04/27/2021	Approved	04/29/2021
Scilone@sotb.com	No	04/27/2021	Invitation Sent	04/27/2021
Tamara.Palmer@capitalone.com	No	04/27/2021	Approved	04/28/2021
Tim.Kreitzer@allegiancebank.com	No	04/27/2021	Invitation Sent	04/27/2021
tyrus.r.brailey@JPMorgan.com	No	04/27/2021	Invitation Sent	04/27/2021
vmweatherby@comerica.com	No	04/27/2021	Invitation Sent	04/27/2021
wabernethy@veritexbank.com	No	04/27/2021	Invitation Sent	04/27/2021
Wayne@capitalbanktx.com	No	04/27/2021	Invitation Sent	04/27/2021

## Participant Detail

### @RISK Technologies

Address 16400 N. Dallas Pkwy Unit 105 Participation Type: Active Supplier  
Dallas, TX 75248

Invitation Date 04/23/2021  
Invitation Type Automatic  
Invitation Email(s)

### 2 Inspire Peace

Address 1808 S. Good Latimer Expressway Participation Type: Active Supplier  
Dallas, TX 75226

Classifications MBE (Primary),SBE,WBE

Invitation Date 04/23/2021  
Invitation Type Automatic  
Invitation Email(s) 2inspirepeace@gmail.com



**Regular Board Meeting**

**8.F.6.**

**Meeting Date:** July 21, 2021

**Title:** Contract Award for Job No. 21/052KJ Bond Counsel Services for HCDE

**Submitted For:** Kendra Jackson, Purchasing

**Submitted By:** Kendra Jackson

**Recommended Action:** Approve

**HCDE Goal(s):** 2. Deliver value responsibly

**Additional Resource Personnel:** Dr. Jesus Amezcua, Kendra Jackson

**Facilities/Technology Approval Needed?:**

**Information**

**Posted Agenda Item:**

**Consideration and Approval of Contract Award for vendors for job no.21/052KJ Bond Counsel Services for HCDE’s Public Facility Corporation as follows:** (1) approval of a pool of vendors for job no. 21/052KJ for the period of 07/21/2021 through 07/20/2026 consisting of the following vendors Orrick, Herrington & Sutcliffe, Escamilla & Poneck, LLP, Hardwick Law Firm, LLC, and Hunton Andrews Kurth LLP; and (2) approval of a resolution authorizing Orrick, Herrington & Sutcliffe LLP to serve as HCDE and HCDE PFC’s Primary Bond Counsel and the remaining firms as Secondary Bond Counsel, subject to annual appropriations of funding.

**Subject:**

Bond Counsel Services

**Rationale:**

The process enacted was a Request for Qualifications (RFQ) to acquire proposals from vendors for Bond Counsel Services for Harris County Department of Education and HCDE's Public Facility Corporation. Eight hundred and seventy (870) invitations were extended for proposals. Four (4) responses were received from vendors. Each response was reviewed for compliance with the requirements of the RFQ, evaluated, and scored. Four vendors offering the best value to HCDE was recommended for an award. The Initial Term of the prospective contract is a period of five (5) years to the vendors stated above in Posted Agenda Item; subject to annual appropriations of funding. The Department may elect, with mutual agreement of the awarded vendor, to extend any contract awarded pursuant to this procurement solicitation for up to two (2) additional five-year terms (individually, a “Renewal Term”). The maximum duration of any contract resulting from this procurement is a total of fifteen (15) years, running from the date of execution of the contract by the authorized representative of the Department. Contracts are in accordance with Texas Education Code Section 44.031(f) and the Professional Services Procurement Act, Chapter 2254 of the Texas Government Code.

**Fiscal Impact**

**Attachments**

- EC Form
- Evaluation Summary
- Participation Detail
- Bond Counsel
- Bond

**Form Review**

Inbox

Reviewed By

Date



**Harris County Department of Education  
Business Office /Purchasing Division**

**EC Form**

**Effectiveness and Compliance Review**

[This form is used to document due diligence by Buyer]

---

To: Purchasing Audit File and Jesus J. Amezcua, Ph.D., CPA, Assistant Supt. for Business

From: Kendra Jackson – Director of Purchasing

Job- Bid or RFQ# and Name: 21/052KJ Bond Counsel Services for Harris County Department of Education and HCDE's Public Facility Corporation

Board Meeting Date: July 21, 2021

Date: July 7, 2021

**Procurement Requirements Applicable:**

Check One

- Under \$2,500 (Requires Division Director and Asst Supt. Approval)
- From \$2,500 to \$49,999 (Requires Buyer, Purchasing Director/CFO Approval)
- Over \$50,000 (per CH Local)
- Cooperative Programs (Requires Board Approval)

I certify that I have reviewed the attached job (bid or RFQ) and certify that all of my actions as a Recommendations Committee Member are within the procurement requirements in accordance with local Board Policies (CH local/legal) and legal (federal and state) policies and administrative guidelines set by the Business Office and the Purchasing Division.

I certify that I have adhered to the Purchasing Policies of HCDE concerning the review of this job (bid or RFQ) to include policies on conflict of interest.

I certify that I am aware of all purchasing policies (CH Local and CH Legal) and administrative procedures of HCDE.

I certify that I am aware of the penalties of not following the purchasing policies and procedures and in specific with section 44.032 of the Texas Education Code which deals with the penalties related to sequential or component purchases.

I further certify that I recommend the issuance of a purchase order after Board approval and execution of a contract.

(Note: This form is required of all jobs (bids and RFQs) prepared by all buyers and Director)

<b>Evaluation Summary - Job no. 21/052KJ - Bond Counsel Services for Harris County Department of Education and HCDE's Public Facility Corporation</b>	<b>Weighted Valued</b>	<b>Orrick Herrington and Sutcliffe, LLP</b>	<b>Escamilla and Poneck, LLP</b>	<b>Hardwick Law Firm, LLC</b>	<b>Hunton Andrews Kurth, LLP</b>
1. Bond Counsel experience in Texas public schools	15	14.50	14.25	6.50	14.50
2. Bond Counsel experience in governmental entities	10	9.75	7.75	8.50	9.00
3. Size/structure of the firm, including staff positions	20	20.00	17.00	14.50	17.50
4. Qualifications of supervisory personnel, consultants, and the team; education, including continuing education courses taken during the past two years; and years and type of experience	45	44.75	40.00	33.25	41.50
5. General direction and supervision to be exercised over the team by the firm's management personnel	5	5.00	4.50	4.25	4.50
6. Clear understanding of the work to be performed; comprehensiveness of the proposal	5	5.00	5.00	5.00	5.00
7. Total long-term cost to HCDE to acquire Vendor's goods and/or services	0	0.00	0.00	0.00	0.00
8. For a contract for goods and services, other than goods and services related to telecommunications and information services, building construction and maintenance, or instructional materials, whether the Consultant or the Consultant's ultimate parent company or majority owner: (A) has its principal place of business in this state; or (B) employs at least 500 persons in this state	0	0.00	0.00	0.00	0.00
9. Other (Previous Work with Governmental Agency)	0	0.00	0.00	0.00	0.00
<b>Total</b>	<b>100</b>	<b>99.00</b>	<b>88.50</b>	<b>72.00</b>	<b>92.00</b>
		<b>Award</b>	<b>Award</b>	<b>Award</b>	<b>Award</b>
		Primary	Secondary	Secondary	Secondary

# Harris County Department of Education

## Participation Detail as of 7/7/2021 03:17:03 PM (CT)

### Bid Information

Bid Creator Kendra Jackson Assistant Director  
 Email kjackson@hcde-texas.org  
 Phone (713) 696-0744  
 Fax (713) 696-0720  
  
 Bid Number 21/052KJ  
 Title Bond Counsel Services  
 Bid Type Request for Qualifications  
 Issue Date 5/14/2021 11:21 AM (CT)  
 Close Date 6/1/2021 02:00:00 PM (CT)

### Participation Summary

Company Name	City, State	Invitation Date	Status	Status Date	Response Date
@RISK Technologies	Dallas, TX	05/14/2021			
2 Inspire Peace	Dallas, TX	05/14/2021			
2*2*4 Solutions Education Consulting Service	Red Oak, TX	05/14/2021			
365 Media (365 Media LLC)	Portsmouth, NH	05/14/2021			
365 Paving & Construction LLC	Mission, TX	05/14/2021			
3rd I Process FX	Houston, TX	05/14/2021			
4.0 GPA	Houston, TX	05/14/2021			
4kboards	Keller, TX	05/14/2021			
4W Solutions, Inc	Houston, TX	05/14/2021			
7Mindsets	Roswell, GA	05/14/2021			
806 Technologies, Inc.	Plano, TX	05/14/2021			
A & R Holdings, LLC	Jacksonville, FL	05/14/2021			
A,N,H. Consulting, LLC.	New Orleans, LA	05/14/2021			
A.I.M. (Assessment Intervention Management, LLC)	San Antonio, TX	05/14/2021			
AAA Painting	Houston, TX	05/14/2021			
Abundance Educational Consulting, LLC	Humble, TX	05/14/2021			
AC Language School (Chavez & Associates)	Sugar Land, TX	05/14/2021			
Academic Learning Company (Velazquez Press)	El Monte, CA	05/14/2021			
Aceves Communications	Houston, TX	05/14/2021			
Achor Counseling & Associates LLC	HOUSTON, TX	05/14/2021			
ACS Engineering & Safety	Spring, TX	05/14/2021			
Acumen Enterprises, Inc.	Desoto, TX	05/14/2021			
AdaptiveX (Test4Me LLC)	Glenarden, MD	05/14/2021			
Adele's Coaching and Consulting	Missouri City, TX	05/14/2021			
Adira LLC	Savannah, TX	05/14/2021			
AdjuStar Services, Inc.	Houston, TX	05/14/2021			
ADMORE BEHAVIORAL THERAPY	Houston, TX	05/14/2021			
Adrian Garcia	Brownsville, TX	05/14/2021			
Advance Plus Therapy Services, LLC	Pasadena, TX	05/14/2021			
ADVANTAGE BENEFIT SOLUTIONS (Stefanick Insurance Services Inc.)	Houston, TX	05/14/2021			
Adwebvertising, LLC (Nick Covanes)	Katy, TX	05/14/2021			
AECOM (AECOM Technical Services Inc)	Houston, TX	05/14/2021			
Agular Systems, Inc.	Austin, TX	05/14/2021			
Alamo HR	San Antonio, TX	05/14/2021			
Alamo Music Center, Inc.	San Antonio, TX	05/14/2021			
Alba Educational Consulting, LLC	Kingwood, TX	05/14/2021			
Albert Johnson III, Inc.	Pearland, TX	05/14/2021			
Albourn Translation Services (Albourn & Associates, LLC)	Arlington, VA	05/14/2021			
Alegna Technologies, Inc.	Kennesaw, GA	05/14/2021			
ALL AMERICAN SPECIALTY CONSTRUCTION LLC	IRVING, TX	05/14/2021			
All Educate Learning Resources	Livingston, TX	05/14/2021			

ALL VALLEY DRUG SCREENS	Brownsville, TX	05/14/2021		
Alliance Financial Ministries, Inc.	Pearland, TX	05/14/2021		
Allovue	Baltimore, MD	05/14/2021		
ALPHA Facilities Solutions	San Antonio, TX	05/14/2021		
Alpha Testing, Inc.	Dallas, TX		Viewed	05/21/2021
AlphaGraphics (Lukitas Inc.)	Houston, TX	05/14/2021		
ALTERING THE EDUCATION XPECTATION LLC	Evanston, IL	05/14/2021		
Altitude Learning (AltSchool, PBC d/b/a Altitude Learning)	San Francisco, CA	05/14/2021		
Amaanah Refugee Services	Houston, TX	05/14/2021		
aMaezing Marketing Group dba Stryker-Munley Group (aMAEZing Marketing Group)	San Antonio, TX	05/14/2021		
Amanda Holdsworth Communications	South Lyon, MI	05/14/2021		
American Fire Systems Inc.	HOUSTON, TX	05/14/2021		
American Productivity & Quality Center	Houston, TX	05/14/2021		
American Vision Marketing LLC	Stafford, TX	05/14/2021		
Amparo Consulting & Design	Grand Junction, CO	05/14/2021		
AMTEX Security Inc.	Corpus Christi, TX	05/14/2021		
Anew Psychological Services, PLLC	Houston, TX	05/14/2021		
AnLar, LLC	Arlington, VA	05/14/2021		
Ann Marie Harbour	Richmond, TX	05/14/2021		
Another Chance Behavioral Consultants LLC	Conroe, TX		Viewed	05/30/2021
APIA Source (APIA Source LLC)	Saginaw, TX	05/14/2021		
Apple Developmental Health	Houston, TX	05/14/2021		
Applications Software Technology Corporation	Naperville, IL	05/14/2021		
Aptim Environmental & Infrastrure	Baton Rouge, LA	05/14/2021		
Arctic Information Technology, Inc.	Anchorage, AK	05/14/2021		
ardurra group	houston, TX	05/14/2021		
Argument-Driven Inquiry	Austin, TX	05/14/2021		
ARMI Consulting (Account Receivable Management, Inc.)	Orlando, FL	05/14/2021		
ARRAY	Bellaire, TX	05/14/2021		
Arts Alive! Inc (ARTS ALIVE!)	Houston, TX	05/14/2021		
As We Grow Learning Center	Houston, TX	05/14/2021		
ASAP Roofing (Koppel & Kozel, LLC)	Tyler, TX	05/14/2021		
ASD Consultants, Inc.	Austin, TX	05/14/2021		
ASmart Consulting	Houston, TX	05/14/2021		
Aspell Services, Inc.	SAN ANTONIO, TX	05/14/2021		
Aspire Works LLC	San Antonio, TX	05/14/2021		
Assoc for the Advancement of Mexican Americans (AAMA)	Houston, TX	05/14/2021		
Astrov & Associates	Frisco, TX	05/14/2021		
AT&T Mobility LLC	Bellaire, TX	05/14/2021		
Atkins Powerhouse Consulting LLC	Fort Worth, TX	05/14/2021		
Atlas Civil Engineering PLLC	Houston, TX	05/14/2021		
Audimation Services Inc	Houston, TX	05/14/2021		
AUSTIN LEARNING CENTER (CANDEO, LLC)	AUSTIN, TX	05/14/2021		
Automated Financial Systems (Robert Beyer Enterprises LLC)	San Antonio, TX	05/14/2021		
Baked With Confidence	Houston, TX	05/14/2021		
Balance Companies (Balance Group, LLC)	Houston, TX	05/14/2021		
Bara Infoware Inc.	Danville, CA	05/14/2021		
Barranco Educational Assessment, Counseling, and Consulting Svcs., PLLC	Montgomery, TX	05/14/2021		
Barstone, Inc.	San Antonio, TX	05/14/2021		
Battleground WTS	Houston, TX	05/14/2021		
BCA DX LABORATORY	Livingston, TX	05/14/2021		
BCS Consulting	Humble, TX	05/14/2021		
BE GLAD LLC	San Jose, CA	05/14/2021		
BEAL Safety and Performance	Sugar Land, TX	05/14/2021		
Bearing Fruit Early Childhood Training	HOUSTON, TX	05/14/2021		
Bedden & Associates, LLC (Bedden)	Richmond, VA	05/14/2021		
Bee Busy Wellness Center	Houston, TX	05/14/2021		
Bell and Smarts	Broken Arrow, OK	05/14/2021		
BenCheri Educational Center	Houston, TX	05/14/2021		
BenefitScape (Benefit Coordinators of America, LLC)	Natick, MA	05/14/2021		

BENNETT MANAGEMENT SOLUTIONS LLC	Spring, TX	05/14/2021		
Best Lead Generation LLC	Conroe, TX	05/14/2021		
Best Practice Associates, Inc.	Houma, LA	05/14/2021		
BIAS Corporation	Atlanta, GA	05/14/2021		
Bio-Rad Laboratories, Inc	Hercules, CA	05/14/2021		
Black Topaz Consulting	Austin, TX	05/14/2021		
Black United Fund of Texas	Houston, TX	05/14/2021		
BlackBeltHelp	Chicago, IL	05/14/2021		
Blaylock Van, LLC	New York, NY	05/14/2021		
BLU PHIRE RESEARCH INSTITUTE INC	HOUSTON, TX	05/14/2021		
BluGreen Pest Control	Wallis, TX	05/14/2021		
BMHR - Better Man HR LLC	SAN ANTONIO, TX	05/14/2021		
BOLDplanning (BOLDplanning, inc)	Nashville, TN	05/14/2021		
Bond Program Management Services	Richards, TX	05/14/2021		
BookerDezigns	Richmond, TX	05/14/2021		
Bookwhisperer, Inc. (Donalyn Miller)	Colleyville, TX	05/14/2021		
Boundaryless Enterprises, LLC	Houston, TX	05/14/2021		
Bracane Company	Plano, TX	05/14/2021		
Brahmarsk Corporation	Sugar Land, TX	05/14/2021		
BrainStorm Advanced Learning Systems	Mansfield, TX	05/14/2021		
Brandi Spencer Consulting	Spring, TX	05/14/2021		
Brandi T. Brown	Manvel, TX	05/14/2021		
Braun Intertec Corporation	Houston, TX	05/14/2021		
Briar Patch	Houston, TX	05/14/2021		
Bridge to Leadership, LLC	Missouri City, TX	05/14/2021		
Bridgepoint Consulting, LLC	Austin, TX	05/14/2021		
Brighter Futures Counseling and Consulting	Houston, TX	05/14/2021		
Bruce Monical Design	Bacliff, TX	05/14/2021		
BTS Consulting (Business Trade and Services, inc.)	Doral, FL	05/14/2021		
Building Solutions	dallas, TX	05/14/2021		
Bureau of Education & Research	Bellevue, WA	05/14/2021		
Business & Financial Management Solutions, LLC	Austin, TX	05/14/2021		
BUSINESS 101 CONSULTANTS & TRAINERS	Houston, TX	05/14/2021		
C Change Consulting	Houston, TX	05/14/2021		
C1S Group, Inc.	Dallas, TX	05/14/2021		
cain & co llc	Concord, TX	05/14/2021		
CALPAA Inc (CALPAA, Inc)	Seattle, WA	05/14/2021		
Canyon Insurance Group	Houston, TX	05/14/2021		
Caperton-Brown & Poole Consulting	Ft. Pierce, FL	05/14/2021		
Capitol Region Education Council	Hartford, CT	05/14/2021		
Career Resource Center	HUMBLE, TX	05/14/2021		
Carmen A. Handy	Corpus Christi, TX	05/14/2021		
Carol Cooper dba N&C Consulting	Garland, TX	05/14/2021		
Casablanca Productions	Spring, TX	05/14/2021		
Catapult Dreams, LLC	Pearland, TX	05/14/2021		
CBRE   Heery (CBRE Heery, Inc.)	Houston, TX	05/14/2021	Viewed	05/15/2021
CBRE Valuation & Advisory Services	Houston, TX	05/14/2021		
CBTS Technology Solutions	Cincinatti, OH	05/14/2021		
CC Assessment Services, Inc	Houston, TX	05/14/2021		
CCS Global Tech (California Creative Solutions, Inc)	Poway, CA	05/14/2021		
CDR Maguire, Inc.	Miami, FL	05/14/2021		
Center for Student Achievement Solutions	New York, NY	05/14/2021		
Center for Toxicology and Environmental Health, LLC.	North Little Rock, AR	05/14/2021		
Central IT Company LLC	Houston, TX	05/14/2021		
Certica Solutions	Wakefield, MA	05/14/2021		
CharacterStrong, LLC	PUYALLUP, WA	05/14/2021		
Charbonnet & Associates	New Orleans, LA	05/14/2021		
Chart Chicks LP	Lufkin, TX	05/14/2021		
Charter School Success, LLC	Galveston, TX	05/14/2021		
Chase in Dreams, Speech and Drama (Deadra Chase)	Houston, TX	05/14/2021		
CHAT (Culture of Health-Advancing Together)	Houston, TX	05/14/2021		
Chazey Partners (Chazey Partners Inc)	Campbell, CA	05/14/2021		

Cheryl R. Vital	Crosby, TX	05/14/2021
Child Care Associates	FORT WORTH, TX	05/14/2021
Childcare Masters LLC	Cypress, TX	05/14/2021
Cindy Puryear Consulting Services (Cindy Puryear)	Houston, TX	05/14/2021
Classware Systems (Classware L.P.)	Dallas, TX	05/14/2021
cLI-Energy and Construction LL	Houston, TX	05/14/2021
Clifton Gunderson LLP	Milwaukee, WI	05/14/2021
Clinical Concepts! (The Entermedia Group, LLC)	Austin, TX	05/14/2021
Club SciKidz Houston (Heir Consulting Group)	Houston, TX	05/14/2021
Coaching Consultants Team	Houston, TX	05/14/2021
Coatings Specialty Development Lab	Cypress, TX	05/14/2021
Code Park Inc	Houston, TX	05/14/2021
CohnReznick LLP	Austin, TX	05/14/2021
Collaborate With Christina	Houston, TX	05/14/2021
Color of Life (Color of Life Community Resource & Activity center)	Houston, TX	05/14/2021
Comflow Mechanical Services	Houston, TX	05/14/2021
Communities In Schools of Houston (Communities In Schools of Houston, Inc.)	Houston, TX	05/14/2021
Community Nutrition Outreach Services (Ellis A Morrow)	Houston, TX	05/14/2021
Comprehensive Cloud Services	Houston, TX	05/14/2021
Conscious Education Consulting, LLC.	Katy, TX	05/14/2021
Consolidated Performance Consulting, LLC.	San Antonio, TX	05/14/2021
Construction Journal	Stuart, FL	05/14/2021
Convergent Nonprofit Solutions	Atlanta, GA	05/14/2021
CoolSpeak, LLC	Pottstown, PA	05/14/2021
Cooperative Strategies	Dublin, OH	05/14/2021
CORE construction services of Texas, Inc.	Frisco, TX	05/14/2021
Cossey's Services, LLC	The Woodlands, TX	05/14/2021
Costello, Inc.	Houston, TX	05/14/2021
Covid Safety Glass (Silent West LLC)	LAS VEGAS, NV	05/14/2021
CPS HR Consulting (Cooperative Personnel Services)	Sacramento, CA	05/14/2021
CRAFT SAFETY INSPECTIONS (JMAC GROUP LLC)	HOUSTON, TX	05/14/2021
Creative Financial Staffing Inc	Houston, TX	05/14/2021
Creatively Inspired Communications (ConSandra Jones)	Austin, TX	05/14/2021
CReed Global Enterprises (CReed Global Media & Production)	Houston, TX	05/14/2021
Crimson Vision Enterprises	Dickinson, TX	05/14/2021
Crowe LLP	Oakbrook Terrace, IL	05/14/2021
Crystal Clear Business Solutions	Sugar Land, TX	05/14/2021
Cyberstar, LLC	Austin, TX	05/14/2021
Cyclone FPV (Cyclone 3D, Inc.)	Spring, TX	05/14/2021
D.A. Lamont Public Adjusters	Springtown, TX	05/14/2021
Dan L. Duncan Tutoring a part of the Children's Learning Institute (University of Texas Health Science Center)	Houston, TX	05/14/2021
Dan St. Romain Educational Consulting, LLC	Universal City, TX	05/14/2021
Danny Steele (Daniel J. Steele)	Birmingham, AL	05/14/2021
David James (David Hebert)	KEMAH, TX	05/14/2021
David Rodriguez	San Antonio, TX	05/14/2021
David Santana	Houston, TX	05/14/2021
David Webb	Pasadena, TX	05/14/2021
DB3 Unlimited Services LLC	San Antonio, TX	05/14/2021
dba Stenhouse Publishers and dba Staff Development for Educators (SDE, Inc.)	Portsmouth, NH	05/14/2021
Deacon Hill Research Associates LLC	Fredericksburg, VA	05/14/2021
Debbie J. Anders Consulting	Cypress, TX	05/14/2021
Decisions	Houston, TX	05/14/2021
DeDe Church & Associates, LLC	AUSTIN, TX	05/14/2021
Defined Learning	Northbrook, IL	05/14/2021
DEMS,LLC	Houston, TX	05/14/2021
Dennis Calloway	Houston, TX	05/14/2021

DG Grafix	Houston, TX	05/14/2021			
DGR United	houston, TX	05/14/2021			
Diamond Business Services, Inc.	Amarillo, TX	05/14/2021			
Dillon Claims & Consulting Services LLC	gonzales, LA	05/14/2021			
Disciplers Inc	Spring, TX	05/14/2021			
DiscoverU	Houston, TX	05/14/2021			
Diverse Consulting Enterprises, Inc.	HOUSTON, TX	05/14/2021			
DK High Steppers (Doris Keener)	Houston, TX	05/14/2021			
DMS Disaster Consultants	Boca Raton, FL	05/14/2021			
DoLogic Inc.	Annandale, VA	05/14/2021			
Doucet & Associates, Inc.	Austin, TX	05/14/2021			
Dr. Jeanne M. Hines	Port Arthur, TX	05/14/2021			
Dr. Ken Brumfield, Learning Empire	Santa Ana, CA	05/14/2021			
Dr. Mary E. White International, LLC	Houston, TX	05/14/2021			
Dr. Mike!	Wimberely, TX	05/14/2021			
Dr. Pope's STEM and Liberal Arts Academy	Pearland, TX	05/14/2021			
Dream Capital International, Inc	Houston, TX	05/14/2021			
DYS HOUSYON YOUTH ASSOCIATION	Houston, TX	05/14/2021			
E3 Alliance	Austin, TX	05/14/2021			
Earl P. Forbrich, Jr. Inc	San Antonio, TX	05/14/2021			
Early Start Development Inc	Humble, TX	05/14/2021			
E-Colors in Education	Austin, TX	05/14/2021			
EDU Specialist, LLC	Lake Dallas, TX	05/14/2021			
Educate To Edify (Educating While Black)	Pearland, TX	05/14/2021			
Education & Business Associates, Inc.	DeSoto, TX	05/14/2021			
Education Partners Solution, Inc.	Sugar Land, TX	05/14/2021			
Education Solutions Now, LLC	Houston, TX	05/14/2021	No Bid	05/26/2021	05/26/2021
Educational Epiphany LLC	WASHINGTON, DC	05/14/2021			
Educational Leadership Consultants	Houston, TX	05/14/2021			
Educational Research and Consulting, PLLC (Cynthia H. Williams, PhD)	Little Rock, AR	05/14/2021			
Educational Systems Consulting	Binghamton, NY	05/14/2021			
Edwards Sutarwalla PLLC	Houston, TX	05/14/2021			
Eichelbaum Wardell Hansen Powell & Mehl,	Austin, TX	05/14/2021			
Elaine Lange	Austin, TX	05/14/2021			
Electric Car Insider (Christopher Alan Consulting)	Spring Valley, CA	05/14/2021			
Elegant Enterprise Wide Solutions, Inc.	Chantilly, VA	05/14/2021			
Elevated Insights	Colorado Springs, CO	05/14/2021			
Elisa Rankin Consulting LLC	Uvalde, TX	05/14/2021			
Elite Change Inc.	Houston, TX	05/14/2021			
Elite Image Tax & Notary Service LLC	Houston, TX	05/14/2021			
Ellington Chastain Educational Initiative	San Antonio, TX	05/14/2021			
Emdin Support Services LLC	Bronx, NY	05/14/2021			
Emergent Risk Solutions	BATON ROUGE, LA	05/14/2021			
Emergent Tree Education	Austin, TX	05/14/2021			
Emma Oliver	Houston, TX	05/14/2021			
empower retirement (great-west life and annuity)	greenwood village, CO	05/14/2021			
Empowered Network Services, LLC	Huffman, TX	05/14/2021			
Energy Saving Advisor Distributors	Dallas, TX	05/14/2021	Viewed	05/17/2021	
engage2learn (Engage! Learning, Inc. dba engage2learn)	Portland, TX	05/14/2021			
Enterprise Fleet Management, Inc.	St. Louis, MO	05/14/2021			
Enterprise Pals, Inc.	Olathe, KS	05/14/2021			
ENTRAM CORP	PORT CHARLOTTE, FL	05/14/2021			
Epic Decisions, LLC	Kingwood, TX	05/14/2021			
ERASCOGroup, LLC	Houston, TX	05/14/2021			
eRate 360 Solutions	Henderson, NV	05/14/2021			
E-Rate Elite Services, Inc.	Owings Mills, MD	05/14/2021			
Escamilla & Poneck, LLP	San Antonio, TX	05/14/2021	Submitted	06/01/2021	06/01/2021
Essential Wellness and Balance	Missouri City, TX	05/14/2021			
eTeachingMe (Love N Learn At Home)	Georgetown, TX	05/14/2021			
Etrainers.org	Machesney Park, IL	05/14/2021			
Evergreen Solutions, LLC	Tallahassee, FL	05/14/2021			
Evolve Holdings Inc	Houston, TX	05/14/2021			
Ewing Strategic Communications	Houston, TX	05/14/2021			
Exceptional Pediatric Therapy, LLC	Houston, TX	05/14/2021			
ExecuTeam Staffing	Houston, TX	05/14/2021			



ExerPlay, Inc	Cedar Crest, NM	05/14/2021		
Exploros (Exploros, Inc.)	Wayland, MA	05/14/2021		
EY (Ernst & Young LLP)	Austin, TX	05/14/2021		
FACILITIES INTEGRATED SOLUTIONS & CONSULTING LLC	CYPRESS, TX	05/14/2021		
Facility Engineering Associates, PC	Fairfax, VA	05/14/2021		
Faith Works Consulting Group, LLC	Houston, TX	05/14/2021		
Fast Forward	Las Vegas, NV	05/14/2021		
Favor Consulting Inc (Demlan Solutions Inc)	Southlake, TX	05/14/2021		
Fazzio Consulting, LLC.	Round Rock, TX	05/14/2021		
Felicity Educational Services	Deerfield, IL	05/14/2021		
Ferrilli	Haddonfield, NJ	05/14/2021		
Fireworx International, LLC	Spring, TX	05/14/2021		
FIRST Educational Resources, LLC	Winneconne, WI	05/14/2021		
Floral Park Consulting LLC	Floral Park, NY	05/14/2021		
Foodservice Peeps LLC	Richmond, TX	05/14/2021		
For The Culture Literacy Development	Humble, TX	05/14/2021		
Forged Ed	Houston, TX	05/14/2021		
Fortify Experts, LLC (Energy Sourcing LLC)	Houston, TX	05/14/2021		
Frame-Work Consult	HOUSTON, TX	05/14/2021		
Freedom Profit Recovery (FPR Holdings, LP)	Irving, TX	05/14/2021		
Freese and Nichols, Inc.	Fort Worth, TX	05/14/2021		
Friends of the British Council USA Inc.	Washington, DC	05/14/2021		
From The Ground up Performance Enhancement (Deanna Voltz)	Houston, TX	05/14/2021		
From The Heart International Educational Services	Nashville, TN	05/14/2021		
FrontGate HR	Lubbock, TX	05/14/2021		
Frontier Services Group	Houston, TX	05/14/2021	Viewed	05/14/2021
Fullidity LLC	Houston, TX	05/14/2021		
Furness Law	Houston, TX	05/14/2021		
G4C Enterprises, LLC	Pflugerville, TX	05/14/2021		
Gary Pollard P.C.	Houston, TX	05/14/2021		
Gastile Consultant Group	Houston, TX	05/14/2021		
Gateway Solutions inc	overland park, KS	05/14/2021		
Gazelle Capital, LLC	Saint Petersburg, FL	05/14/2021		
Generation Ready	New York, NY	05/14/2021		
Generation Teach Inc.	Boston, MA	05/14/2021		
Gene's Machine, INC.	Victoria, TX	05/14/2021		
Gentle Minds Tutoring	Missouri City, TX	05/14/2021		
GermBlast (Infection Controls, Inc.)	Lubbock, TX	05/14/2021		
GET Technology and Accounting Solutions	Santo, TX	05/14/2021		
Getting Sorted (G. Yess Fisher & Co., LLC)	The Woodlands, TX	05/14/2021		
Gibson Consulting Group	Austin, TX	05/14/2021		
Gifting Grounds	Houston, TX	05/14/2021		
Gilberto D. Soto	Laredo, TX	05/14/2021		
GilCat Solutions (Gloria Lastra)	Spring, TX	05/14/2021		
Girlstart	Austin, TX	05/14/2021		
Glass View of Tech	Spring, TX	05/14/2021		
Global Education Systems Alliance (William H Prouty PhD)	Sun City, CA	05/14/2021		
GLOBAL EDUCATIONAL SOLUTIONS LLC	Canton, MI	05/14/2021		
GMC CONSULTANTS,LLC	Houston, TX	05/14/2021		
GOD FEARING POWER HOUSE (POWER ROCK COMMUNITY CENTR)	HOUSTON, TX	05/14/2021		
Golden Mountain Consulting L.L.C	Houston, TX	05/14/2021		
Golding Touch Education Consul	Manvel, TX	05/14/2021		
GO-Strategic Management Services	Houston, TX	05/14/2021		
GovSense	Alpharetta, GA	05/14/2021		
GPR Ventures, LLC	Montgomery, TX	05/14/2021		
Gray Mechanical (Gray Mechanical, LLC)	Houston, TX	05/14/2021		
Gray Step Software	El Dorado Hills, CA	05/14/2021		
Gray&Pape, Inc.	Cincinnati, OH	05/14/2021		
Greatest in the Kingdom Ministries	The Woodlands, TX	05/14/2021		
Green Delete Inc.	Frankfort, IL	05/14/2021		
Grow Minds Consulting LLC	HOUSTON, TX	05/14/2021		
GT Educational Services (GT Educational Services, L.L.C.)	Houston, TX	05/14/2021		

GW Implementation Solutions	Nokomis, FL	05/14/2021			
H. J. DEBOER & ASSOCIATES	KINGWOOD, TX	05/14/2021			
Hagerty Consulting, Inc. (Freeman)	Evanston, IL	05/14/2021			
Hallmark Mitigation & Construction	Kingwood, TX	05/14/2021			
Happy Chapters, LLC	Austin, TX	05/14/2021			
Hardwick Law Firm, LLC	Houston, TX		Submitted	06/01/2021	06/01/2021
Harmony Public Schools	Houston, TX	05/14/2021			
Harris County Houston Patrol, Inc.	Houston, TX	05/14/2021			
HARRIS-JONES STAFFING & RECRUITING	Katy, TX	05/14/2021			
Harvesting Wealth LLC	Houston, TX	05/14/2021			
Haude Tutoring	Spring, TX	05/14/2021			
Hayhouse Projects LLC	Brooklyn, NY	05/14/2021			
Healing Species of Texas	Montgomery, TX	05/14/2021			
Heartwork Trending Counseling and Consulting, PLLC (Heartwork Trending Consulting Services)	Houston, TX	05/14/2021			
Heavenly Service, LLC	Webster, TX	05/14/2021			
Helping All Leaders Obtain Success (HALOS) (Helping All Leaders Obtain Success)	Homewood, IL	05/14/2021			
HENECO ENGINEERING AND CONSULTING	Houston, TX	05/14/2021			
Henry Deslaurier	Houston, TX	05/14/2021			
Heritage Institute of Sustainability LLC	Dallas, TX	05/14/2021			
Herrera Talent Strategies LLC	Houston, TX	05/14/2021			
HillCo Partners, LLC	Austin, TX	05/14/2021			
HiMac Center for Creative Thinking	Humble, TX	05/14/2021			
Hoensty Environmental Services	Houston, TX	05/14/2021			
Hogan's consulting (Deon I Hogan)	Pflugerville, TX	05/14/2021			
Holland Energy Consulting	Houston, TX	05/14/2021			
Holtz/Adams Construction and Consulting, LLC	Universal City, TX	05/14/2021			
Honesty Construction Group (HCG Management LLC)	Manvel, TX	05/14/2021			
Honor Moorman Consulting	Brazoria, TX	05/14/2021			
Hooper Strategies	Granbury, TX	05/14/2021			
Hope Over Hurt	Houston, TX	05/14/2021			
HORIZON SW PROPERTIES	SUGAR LAND, TX	05/14/2021			
Horn Solutions, Inc.	Sugar Land, TX	05/14/2021			
HORNE LLP	Austin, TX	05/14/2021			
Houston ISD - Medicaid Finance & Consulting Services	Houston, TX	05/14/2021			
Houston Museum of Natural Science	Houston, TX	05/14/2021			
Houston Press, LP	Houston, TX	05/14/2021			
Houston Urban Debate League	Houston, TX	05/14/2021			
HRchex, LLC (Intellisoft II, Inc.)	Irving, TX	05/14/2021			
HTEC-Houstons Training and Education Center, Inc. (Phillips)	Houston, TX	05/14/2021			
Hunt, Guillot & Associates	Baton Rouge, LA	05/14/2021			
Hunton Andrews Kurth LLP	Houston, TX		Submitted	06/01/2021	06/01/2021
Husch Blackwell LLP	Houston, TX	05/14/2021			
IA-Advanced Telecom Solutions, LLC	Richmond, TX	05/14/2021			
ICC Thermal Mapping and Data Analytcs (Infrared Concepts Corporation)	Maitland, FL	05/14/2021			
ID Media, Inc	Chicago, IL	05/14/2021			
IdentiFIE Special Education, LLC	Houston, TX	05/14/2021			
IECGTX (Insurance Estimating & Consulting Group, LLC)	SPRINGTOWN, TX	05/14/2021			
Imagine Excellence.Inc	Houston, TX	05/14/2021			
Imagine Me Academy	Crosby, TX	05/14/2021			
IMPACT 360	Missouri City, TX	05/14/2021			
IMS Dodge	San Diego, CA	05/14/2021			
Indatatech (Instant Data Technologies, Inc.)	San Antonio, TX	05/14/2021			
Infinite Education Solutions	Desoto, TX	05/14/2021			
Infinite Solutions Enterprises (The DDance Group, Inc.)	Glen Allen, VA	05/14/2021			
Infojini,Inc.	Columbia, MD	05/14/2021			
Ink International	Lawrenceville, GA	05/14/2021			
InnerChange Consulting Group	Houston, TX	05/14/2021			
Innovation Bridge, Inc.	Sacramento, CA	05/14/2021			
Innovative Texas Strategies LLC	Houston, TX	05/14/2021			

InnovsiteLLC	Decatur, GA	05/14/2021
Insight Investments, LLC	Costa Mesa, CA	05/14/2021
Instead	Kingwood, TX	05/14/2021
Institute for Building Technology and Safety	VA, VA	05/14/2021
Integrality (Integrality, LLC)	Dallas, TX	05/14/2021
Integrity Operations	Katy, TX	05/14/2021
Intellyk Inc	Piscataway, NJ	05/14/2021
Interprise/Southwest Interior & Space Planning, In	Addison, TX	05/14/2021
Invo Healthcare Associates (Invo Healthcare Associates, LLC)	Jamison, PA	05/14/2021
IOS Acquisitions LLC	New York, NY	05/14/2021
IPM Asset Solutions, Inc.	Houston, TX	05/14/2021
IP Terra International Corporation	Houston, TX	05/14/2021
I-Raos, Inc	Pearland, TX	05/14/2021
Irving Hernandez	Austin, TX	05/14/2021
ISE International Group	Bethesda, MD	05/14/2021
ISES Corporation	Duluth, GA	05/14/2021
Its Your Time To Flourish	Houston, TX	05/14/2021
itsQuest, Inc.	Lubbock, TX	05/14/2021
iWRITE (I Write)	Houston, TX	05/14/2021
J Dorthen Martin, Speaker, Life Coach, Image Consultant	Houston, TX	05/14/2021
Jackson Walker L.L.P.	Dallas, TX	05/14/2021
JAGGAER	Morrisville, NC	05/14/2021
Jaime Rios Financial Services Inc. (Money Concepts International Inc.)	Corpus Christi, TX	05/14/2021
Janet Pozmantier, M.S., LPC, LMFT, RPT (Janet Pozmantier)	Houston, TX	05/14/2021
Javier Lopez	Houston, TX	05/14/2021
JC Stonewall Constructors, LP	Houston, TX	05/14/2021
Jean Polichino Consulting, LLC	Fredericksburg, TX	05/14/2021
Jennifer Serravallo Consulting, LLC	South Orange, NJ	05/14/2021
JER HR Group LLC	New York, NY	05/14/2021
Jerry Gaither Enterprise	HOUSTON, TX	05/14/2021
Jigsaw Learning LLC (TeachTown)	Woburn, MA	05/14/2021
JLA Construction Solutions	Houston, TX	05/14/2021
JLL (Jones Lang LaSalle, Americas, Inc.)	Houston, TX	05/14/2021
JLL Valuation & Advisory Services, LLC	Houston, TX	05/14/2021
Johnson Consulting (Adrian B. Johnson)	Houston, TX	05/14/2021
Johnston, LLC	Houston, TX	05/14/2021
Jon M. Warren, LLC	Decatur, TX	05/14/2021
Jones Lang LaSalle (JLL)	Houston, TX	05/14/2021
Jose Villarreal Consulting Services	Houston, TX	05/14/2021
Journeys Managing Group LLC	Houston, TX	05/14/2021
Joyce Davis/Erin Whitney	Houston, TX	05/14/2021
JPMorgan	Houston, TX	05/14/2021
JPMorgan Chase	Fort Worth, TX	05/14/2021
JQ Infrastructure, LLC	Dallas, TX	05/14/2021
JS&D Sports Development Outreach Ministries	Humble, TX	05/14/2021
K Gab Assessments, Inc	Missouri City, TX	05/14/2021
K&R Group, INC	Houston, TX	05/14/2021
K12 Food Pros	La Mesa, CA	05/14/2021
K12 Insight	Herndon, VA	05/14/2021
K2 Consulting (K2 Construction Consultants, Inc.)	Bethesda, MD	05/14/2021
KAEKA GROUP INC	Lacey, WA	05/14/2021
Kagan Publishing & Professional Development	San Clemente, CA	05/14/2021
Karczewski Bradshaw, LLP	Nacogdoches, TX	05/14/2021
KATTA INFOTEK INC	HOUSTON, TX	05/14/2021
KCP Educational Consulting (Kristi Clarkson Pharaon)	Brenham, TX	05/14/2021
Keey Group LLC	Rosharon, TX	05/14/2021
Kennesaw State University iTeach (Elkins Pointe MS)	Kennesaw, GA	05/14/2021
Keter Environmental Services	Indianapolis, IN	05/14/2021
Keys to Literacy	Rowley, MA	05/14/2021
KGBTexas Communications	Houston, TX	05/14/2021
KH Literacy Education LLC (Kristen Leanne Henry)	San Antonio, TX	05/14/2021

Kijo Consulting LLC	Houston, TX	05/14/2021		
Kiln Services of North Texas	Highland Village, TX	05/14/2021		
Kinetic Potential Scholars (Digital Network Group)	Largo, MD	05/14/2021		
Kingham Dalton Wilson, Ltd.	Houston, TX	05/14/2021		
KLD PLAYSCAPES USA (TWO WORD COMPANY LLC)	Boca Raton, FL	05/14/2021		
KMD Hospitality (KMD Hospitality LLC)	Humble, TX	05/14/2021		
Konnecting the Dots	Houston, TX	05/14/2021	Viewed	05/17/2021
KTM Educational Consulting, LLC	San Antonio, TX	05/14/2021		
L&S Associates, LLC	Montgomery, TX	05/14/2021		
L.SMURPHE.F Institute; Solutions by L.SMURPHE.F; L.SMURPHE.F Productions (L.SMURPHE.F Enterprises, Ltd. Co.)	League City, TX	05/14/2021		
La Capra Associates, Inc.	Boston, MA	05/14/2021		
Lady Liberty Group LLC	Eules, TX	05/14/2021		
Lan Nguyen	Houston, TX	05/14/2021		
Language Dynamics Group	Laramie, WY	05/14/2021		
Language Kids Houston, LLC	Sugar Land, TX	05/14/2021		
Lantana Communications	Arlington, TX	05/14/2021		
LATT Evaluations and Services, PLLC (La Shaun Arzu, PLLC)	Houston, TX	05/14/2021		
Launch Point CDC, Inc.	Houston, TX	05/14/2021	Unsubmitted	05/25/2021
LaVondia Menephee	Houston, TX	05/14/2021		
LBNM Corporation	Richmond, TX	05/14/2021		
Leading School Learning	Cypress, TX	05/14/2021		
Learning Omnivores (William Sommers)	Austin, TX	05/14/2021		
Lee Rutledge Consulting (Rutledge)	Austin, TX	05/14/2021		
Legends Do Live	Missouri City, TX	05/14/2021		
Leidos, Inc.	Maitland, FL	05/14/2021		
Levy's Tutorial and Enrichment Center (Mary Baumann)	Houston, TX		No Bid	05/28/2021 05/28/2021
Libra-Tech Corporation	Argyle, TX	05/14/2021		
Licensed To Solve (Dukes Global Works, INC)	CROSBY, TX	05/14/2021		
Lighthouse Groups LLC	Saint Louis, MO	05/14/2021		
Linder Consulting LLC	AUSTIN, TX	05/14/2021		
Liquid Studio Group	Laredo, TX	05/14/2021		
Lisa K Bailey	Missouri City, TX	05/14/2021		
Live Green Teams (CALPAA, Inc)	Seattle, WA	05/14/2021		
Logyx	Mountain View, CA	05/14/2021		
Lone Star Security Shield, Inc.	Houston, TX	05/14/2021		
Look to Success, LLC (Michelle Lee Pina)	Houston, TX	05/14/2021		
Love 2 the Max	Houston, TX	05/14/2021		
Lovescaping LLC	Houston, TX	05/14/2021		
Lowes Companies Inc	Mooresville, NC	05/14/2021		
LQI Consulting Group, LLC	Round Rock, TX	05/14/2021		
L-Sync, LLC	Grand Prairie, TX	05/14/2021		
Lucy Anderson	Houston, TX	05/14/2021		
Lurie, llp	Minneapolis, MN	05/14/2021		
Lynn Gomes, LLC (Lynn Gomes)	Houston, TX	05/14/2021		
M&H Lighting Systems (Mapenzi Group)	Pearland, TX	05/14/2021		
M.E.N. (Mentoring, Educating & Nurturing) Incorporated (MEN Inc.)	Houston, TX	05/14/2021	No Bid	05/14/2021 05/14/2021
M3 Inc	Brooklyn, NY	05/14/2021		
Main Stop Testing Svcs	Houston, TX	05/14/2021		
Majestic Transportation	Pearland, TX	05/14/2021		
Maker Maven	Tomball, TX	05/14/2021		
Makr U	Spring, TX	05/14/2021		
Malor & Company Inc	New York, NY	05/14/2021		
Marathon Partners Consulting	Moon Township, PA	05/14/2021		
Mark Collins Construction LLC	League City, TX	05/14/2021		
Mark J. Rogers	Austin, TX	05/14/2021		
Mark Matranga	Fort Worth, TX	05/14/2021		
Marketing Addiction Inc.	Houston, TX	05/14/2021		
Marseal Group	Roanoke, TX	05/14/2021		
Mary Benton Communications and Public Affairs	Houston, TX	05/14/2021		
MAS Solutions LLC.	Fulshear, TX	05/14/2021		
Math-A-Matics Tutoring,LLC	Houston, TX	05/14/2021		

Maxim Healthcare Staffing Services, Inc.	San Luis Obispo, CA	05/14/2021		
MAXIMUS	Reston, VA	05/14/2021		
MCA Communications	Houston, TX	05/14/2021		
McConnell & Jones LLP	Houston, TX	05/14/2021		
McKinstry (McKinstry Essention, Inc.)	Dallas, TX	05/14/2021		
MCP Professional Services (Dr. Deloris L. Nelson)	Houston, TX	05/14/2021		
Mediators of Texas (Austin Texas Mediators LLC)	Florence, TX	05/14/2021		
Medicaid Claim Solutions of Texas, Inc.	Mansfield, TX	05/14/2021		
Melba Figueroa (HonestRx Consulting LLC)	Southlake, TX	05/14/2021		
MERCER TECHNOLOGIES FIRM	Gary, IN	05/14/2021		
Metamorphosis Concepts	Manvel, TX	05/14/2021		
Meveau (Mercedes Watkins)	Houston, TX	05/14/2021		
Michael Best Strategies	Madison, WI	05/14/2021		
Microburst Learning, LLC	Columbia, SC	05/14/2021		
Mills Systems Solutions, LLC	Farmers Branch, TX	05/14/2021		
Millunzi & Associates	The Woodlands, TX	05/14/2021		
Minding YOB Services, LLC	Arlington, TX	05/14/2021		
Mitaja Corporation	Fulton, MD	05/14/2021		
Mixxdd Marketing	Kenedy, TX	05/14/2021		
ML Deer Construction	Houston, TX	05/14/2021		
MMG Consulting Partners (Maryland Grier-Union)	Houston, TX	05/14/2021		
MNB Services	Houston, TX	05/14/2021		
Modified Logic	Prosper, TX	05/14/2021		
Monica Lewis School of Etiquette	Spring, TX	05/14/2021		
Moore Counseling and Psychological Services (Lorenzo Moore)	Houston, TX	05/14/2021		
Mosley School of Oratory	Houston, TX	05/14/2021		
MPACT STRATEGIC CONSULTING, LLC	Houston, TX	05/14/2021		
MSB Consulting LLC	Austin, TX	05/14/2021		
MSys inc	washington, DC	05/14/2021		
MVHL Consulting, LLC	San Antonio, TX	05/14/2021		
Namitzi Yoga (Mitzi Henderson)	HOUSTON, TX	05/14/2021		
Nasare Enterprises,LLC.	Houston, TX	05/14/2021		
National Energy Solutions	Houston, TX	05/14/2021		
NationSync (NationSync Corporation)	Houston, TX	05/14/2021		
Nazca Technologies and Consulting LLC	MONTGOMERY, TX	05/14/2021		
NEDRP, LLC (RD360 EDUCATIONAL CONSULTING)	Canyon Lake, TX	05/14/2021		
NERDY BIRDIE (ENOVATEKK)	SPRING, TX	05/14/2021		
New Spectrum Educational Consultants (Civil Society Educational Consultants)	Houston, TX	05/14/2021		
New Teacher Center	Santa Cruz, CA	05/14/2021		
Newspring	Houston, TX	05/14/2021		
Nichelle Pinkney, The Urban Scholar, Independent Consultant (Nichelle Pinkney)	Houston, TX	05/14/2021		
no bully here	PASADENA, TX	05/14/2021		
NO EGO APPAREL (NO EGO INC)	AUSTIN, TX	05/14/2021		
NuHealth, Inc.	Houston, TX	05/14/2021		
Nurture to Blossom Services, Inc.	Houston, TX	05/14/2021		
Nuvalo LLC	Gig Harbor, WA	05/14/2021		
Nylinka School Solutions	Kensington, MD	05/14/2021		
Oak Hill Technology, Inc.	Driftwood, TX	05/14/2021		
Odigo Services LLC	Houston, TX	05/14/2021		
O'Hanlon, Demerath & Castillo	Austin, TX	05/14/2021		
Olivier, Inc.	Dallas, TX	05/14/2021		
Omega Engineers, Inc.	Houston, TX	05/14/2021		
Ondi Love Center Ministries	Houston, TX	05/14/2021		
One Source International, LLC	Houston, TX	05/14/2021		
One Way Education, LLC	Houston, TX	05/14/2021		
Operations Contracting Agency LLC	Schertz, TX	05/14/2021		
Optima Train (Delwar Enterprises LLC)	Houston, TX	05/14/2021		
Optimum Lifestyle CDC (www.olcdonline.org)	Houston, TX	05/14/2021		
Orrick, Herrington & Sutcliffe LLP	Houston, TX	05/14/2021	Submitted	05/31/2021 05/31/2021
Own the Room Communication Coaching & Consulting (Rukiya M. Akua)	Houston, TX	05/14/2021		
Ozeal Consulting Group (Oziel Enriquez)	Sugar Land, TX	05/14/2021		

P Eugene Turner	Waller, TX	05/14/2021
Pangea Biological (Okapi Environmental Group, Inc.)	Carlsbad, CA	05/14/2021
Panorama Education	Boston, MA	05/14/2021
Parker and Jamison LLC	Irving, TX	05/14/2021
Patricia Monticello Kievlan (Patricia Marie Kievlan)	The Woodlands, TX	05/14/2021
Payton, Nix & Associates, LLC	LUCAS, TX	05/14/2021
Pcubed (Program Planning Professionals)	Ann Arbor, MI	05/14/2021
Penelton Consulting Services, LLC	Houston, TX	05/14/2021
Personal Touch Therapy (Shontai Thomas)	Houston, TX	05/14/2021
Personnel Evaluation, Inc.	Milwaukee, WI	05/14/2021
PESG of Texas	Houston, TX	05/14/2021
PHD Resources & Taxes	Houston, TX	05/14/2021
Pinnacle Workforce Strategies	Tucson, AZ	05/14/2021
Piper Sandler & Co.	Houston, TX	05/14/2021
Pittman Training (Vision Educational Solutions)	Dallas, TX	05/14/2021
Plante & Moran, PLLC	Southfield, MI	05/14/2021
Plexos Group LLC	Baton Rouge, LA	05/14/2021
Point Alliance Solutions	Spring, TX	05/14/2021
Porter Brown Associates	Alachua, FL	05/14/2021
Positive Behavior Supports Corp	IRVING, TX	05/14/2021
Postlethwaite & Netterville APAC (Lacher)	Baton Rouge, LA	05/14/2021
Powell-Leon, LLP	Austin, TX	05/14/2021
Power Institute LLC	Missouri City, TX	05/14/2021
Power of Choosing Inc.	Texas, TX	05/14/2021
Practical Parent Education	Mckinney, TX	05/14/2021
Precision Medical Billing (PMB Precision Medical Billing, Inc.)	Houston, TX	05/14/2021
Premier Employee Solutions	Provo, UT	05/14/2021
Premiere Speakers Bureau	Franklin, TN	05/14/2021
Presidential Staffing Solutions	San Antonio, TX	05/14/2021
Price Consulting, Inc.	Houston, TX	05/14/2021
Proactive Thought Leaders, LLC	Arlington, TX	05/14/2021
ProBizAssoc.com (Beth Philley)	Canton, OH	05/14/2021
Probolsky Research	Newport Beach, CA	05/14/2021
PROCEDEO	Fort Worth, TX	05/14/2021
Prodigy, LLC	Lewes, DE	05/14/2021
Productive Ventures	Spring, TX	05/14/2021
Professional Credit Service (Ray Klein Inc)	Vancouver, WA	05/14/2021
Projects-Matter (Projects-Matter LLC)	Houston, TX	05/14/2021
Pronto Shipping and Packaging Services Inc.	Houston, TX	05/14/2021
Prosperity Project Management LLC (N/A)	Washington, DC	05/14/2021
PROTECHT Management Group, LLC	Austin, TX	05/14/2021
Protection Engineering Consultants LLC	Austin, TX	05/14/2021
Protiviti	Houston, TX	05/14/2021
PSST, LLC (PSST Acquisition, LLC)	Louisville, KY	05/14/2021
PST Services, Inc., a McKesson company (PST Services, Inc.)	Alpharetta, GA	05/14/2021
Public Works LLC	West Chester, PA	05/14/2021
Purposeful Parents	Webster, TX	05/14/2021
PVH Consulting Group LLC	Austin, TX	05/14/2021
Rachel Brownlie	Houston, TX	05/14/2021
Ramos & Harrison	Corpus Christi, TX	05/14/2021
RDI Global Services	El Paso, TX	05/14/2021
RDI Mechanical	Houston, TX	05/14/2021
Real Good Technologies	Austin, TX	05/14/2021
Recruiting In Motion	Orlando, FL	05/14/2021
Recruiting Source International	Katy, TX	05/14/2021
Reflective Energy Solutions	Hackensack, NJ	05/14/2021
Region One Education Service Center	Edinburg, TX	05/14/2021
Reliable R&R Training Services	Dallas, TX	05/14/2021
Reliant Elevators (Reliant Elevators, LLC)	Joshua, TX	05/14/2021
Relocation Strategies (Luo & Chang Investment LLC)	houston, TX	05/14/2021
Remember When Kids Were Kids (Jaelijah)	Spring, TX	05/14/2021
Remy Dillenseger	Houston, TX	05/14/2021

Resolute Educational Solutions, L.L.C.	Detroit, MI	05/14/2021		
Responsive Learning (Responsive Learning, LP)	El Paso, TX	05/14/2021		
RG Guillory Education & Consulting, LLC	Houston, TX	05/14/2021		
Rice & Associates, PC	Houston, TX	05/14/2021		
Richards/Carlberg (Richards Carlberg, Inc.)	Houston, TX	05/14/2021		
Rising Star Academy	Houston, TX	05/14/2021		
Rivera-Vega Group, LLC.	San Antonio, TX	05/14/2021	Viewed	05/14/2021
RND Technology	Houston, TX	05/14/2021		
Rogers, Morris & Grover, LLP	Houston, TX	05/14/2021		
Roland Gonzales	Spring, TX	05/14/2021		
RR CONNECTION CONSULTING	Duncanville, TX	05/14/2021		
Rukaz Kultura	HOUSTON, TX	05/14/2021		
S Corporation	Phila, PA	05/14/2021		
s3strategies	Lubbock, TX	05/14/2021		
Sabari Tech Solutions LLC	Richmond, TX	05/14/2021		
Santos Alliances	Austin, TX	05/14/2021		
SBC Consulting (Tammy Smithers)	Houston, TX	05/14/2021		
SBLM Architects	New York, NY	05/14/2021		
SCG Business Services, LLC	Douglasville, GA	05/14/2021		
School Food Service Innovations	Jourdanton, TX	05/14/2021		
Schulman, Lopez, Hoffer & Adelstein	Houston, TX	05/14/2021		
Schultz Center for Teaching and Leadership, Inc.	Jacksonville, FL	05/14/2021		
Science Unlimited, LLC	Missouri City, TX	05/14/2021		
Second Chance Technology Edge High School	Houston, TX	05/14/2021		
ServiceMaster Recovery Management (Service Environments of Texas, Inc.)	Kingwood, TX	05/14/2021		
Session Tax Consulting & Grant Writing (Session Tax Consulting and grant writing)	HOUSTON, TX	05/14/2021		
Shaneka Smith	Houston, TX	05/14/2021		
Sharron Helmke	Dickinson, TX	05/14/2021		
Shepherd Government Services Group (SGSG, LLC)	Carrollton, TX	05/14/2021		
Shine Bright Tutoring (LPOH, LLC)	Pearland, TX	05/14/2021		
Sierra Consulting, Inc	Itasca, IL	05/14/2021		
Sigma Consulting Corp.	Metairie, LA	05/14/2021		
Sign Advisors (Cost Advisors of Texas, LLC)	Houston, TX	05/14/2021		
SilkWeb Consulting and Development, LLC	Scottsdale, AZ	05/14/2021		
SimiDigi Inc	Garland, TX	05/14/2021		
Sketch City	Houston, TX	05/14/2021		
Sky Creations (Rachael Bassey)	Midland, TX	05/14/2021		
Sky's the Limit	Houston, TX	05/14/2021		
SL King and Associates	Atlanta, GA	05/14/2021		
Slalom (Slalom LLC)	Houston, TX	05/14/2021	Viewed	05/14/2021
SLL Services, LLC	Palestine, TX	05/14/2021		
Smart Scholars Foundation	Houston, TX	05/14/2021		
Smarter HR Solutions	Houston, TX	05/14/2021		
SMARTOX	Irving, TX	05/14/2021		
SMRT Solutions (SMRT Consulting LLC)	Washington DC, DC	05/14/2021		
SOA Fin1st	Pearland, TX	05/14/2021		
Social Motion, Inc.	Houston, TX	05/14/2021		
Social Studies Success	Spring, TX	05/14/2021		
Softline International USA, Inc	Miami, FL	05/14/2021		
Solel International	Houston, TX	05/14/2021		
Solix Inc. dba Sivic Solutions (Sivic Solutions Group LLC)	Parsippany, NJ	05/14/2021		
south texas boiler	houston, TX	05/14/2021		
South Texas Counseling and Mentoring : Adult Education	Houston, TX	05/14/2021		
Southeast Technical Solutions	League City, TX	05/14/2021		
SPDF KIDS	Houston, TX	05/14/2021		
Special Evaluations & Consulting of Texas	Dallas, TX	05/14/2021		
Springsted Human Capital Advisors	St. Paul, MN	05/14/2021		
SPZ GLOBAL ENERGY LLC	north bergen, NJ	05/14/2021		
SSCI Environmental (Separation Systems Consultants, Inc.)	Houston, TX	05/14/2021		
SSG-MUSIC	LAS VEGAS, NV	05/14/2021		
Staff Hunt LLC	Houston, TX	05/14/2021		

Standard Morgan Partners, LTD	Houston, TX	05/14/2021			
Steam Kidstitute (Insight Community Resources Inc)	Houston, TX	05/14/2021			
STEM Urban Perspective (Science, Technology, Engineering with an Urban Perspective)	Humble, TX	05/14/2021			
Sterling Empowerment	HOUSTON, TX	05/14/2021			
Sterling Staffing Solutions (Maceo Carter Investments, LLC)	Sugar Land, TX	05/14/2021			
Sterling Therapy & Rehabilitation	SUGAR LAND, TX	05/14/2021			
Stetson & Associates, Inc.	Houston, TX	05/14/2021			
Steve Spangler Inc.	Littleton, CO	05/14/2021			
Stevenson Workshop and Seminar Solutions	league city, TX	05/14/2021			
Stifel, Nicolaus & Company, Inc.	Houston, TX	05/14/2021			
Stone Oak Solutions, LLC	New Braunfels, TX	05/14/2021			
Storytelli' Time (MARY JO HUFF)	NEWBURGH, IN	05/14/2021			
Strahan Cain, PLLC	Houston, TX	05/14/2021			
Straight Defined	Copperas Cove, TX	05/14/2021			
Straight Line Management (Straight Line Management LLC)	San Antonio, TX	05/14/2021			
Strategar (Strategar LLC)	Addison, TX	05/14/2021			
Strategic Partnerships, Inc.	Austin, TX	05/14/2021			
Strategic Solutions Group	Needham, MA	05/14/2021			
STRAUS SYSTEMS INC	STAFFORD, TX	05/14/2021			
Streamline Health Services	San Juan Capistrano, CA	05/14/2021			
Students of Strength, Inc.	Cambridge, MA	05/14/2021			
Successful Starters Learning Academy II	Houston, TX	05/14/2021			
Supporting Educators Daily	Missouri City, TX	05/14/2021			
Susan M. Catlett, Ph.D., BCBA-D	Houston, TX	05/14/2021			
SWA International Company	Houston, TX	05/14/2021			
Table SALT Group	Houston, TX	05/14/2021			
Tammy Rodney	Houston, TX	05/14/2021			
Tandi Oil and Gas LLC	KATY, TX	05/14/2021			
TCT Enterprises, LLC	Houston, TX	05/14/2021			
Teach2Learn (Elliott and McMahon)	Friendswood, TX	05/14/2021			
Teaching Strategies, LLC	Bethesda, MD	05/14/2021			
Team Driven Technology Inc.	Fort Worth, TX	05/14/2021			
TeamLogic IT (Philoxenus, Inc.)	Houston, TX	05/14/2021			
Tecnics Consulting, Inc.	Houston, TX	05/14/2021			
TEEN TRUTH (TEEN TRUTH, LLC)	DRIPPING SPRINGS, TX	05/14/2021			
Tekgration LLC	San Antonio, TX	05/14/2021			
Tetra Tech, Inc.	Maitland, FL	05/14/2021			
Texan-French Alliance for the Arts	Houston, TX	05/14/2021			
Texans Together Education Fund Inc	Houston, TX	05/14/2021			
Texas Art Supply Company	Houston, TX		No Bid	06/01/2021	06/01/2021
Texas Association of African American Chambers of Commerce (TAAACC)	Austin, TX	05/14/2021			
Texas Educational Consultative Services, Inc.	Austin, TX	05/14/2021			
Texas Initiative Programs (The K16 Ready Society, Inc.)	Fort Worth, TX	05/14/2021			
Texas STAAR Publishing, LLC	Sugarland, TX	05/14/2021			
Texas State Billing Services Inc	Kyle, TX	05/14/2021			
TexConnect Communications, LLC	Brazoria, TX	05/14/2021			
The Afterschool Professional	Pflugerville, TX	05/14/2021			
The A-List Network, LLC (Stephanie Belton)	Rosharon, TX	05/14/2021			
The Bob Pike Group	Bloomington, MN	05/14/2021			
The Box Program (Box Program)	Baytown, TX	05/14/2021			
The Business Concierge (Goodwill Houston)	Houston, TX	05/14/2021			
The Carmona Firm, PLLC	Houston, TX	05/14/2021			
The Christopher Quinn Group Inc.	Dallas, TX	05/14/2021			
The CNA Corporation (CNA)	Arlington, VA	05/14/2021			
The Danielson Group	Chicago, IL	05/14/2021			
The Donatto Group	Houston, TX	05/14/2021			
The E2 Group, Inc.	Sugar Land, TX	05/14/2021			
The Educator Collaborative	Astoria, NY	05/14/2021			
The Fulton Law Group PLLC	Houston, TX	05/14/2021			
The Green Alliance	Katy, TX	05/14/2021			
The Hanover Research Council, LLC	Arlington, VA	05/14/2021			



The Harris Foundation	Houston, TX	05/14/2021			
The Healthy School Food Collaborative	New Orleans, LA	05/14/2021			
The K.N.E.W. Solutions (Keschia Matthews)	FRESNO, TX	05/14/2021			
The KD Company (Kim Y. Davis Enterprises, LLC)	Houston, TX	05/14/2021			
The King & Associates Firm	Brazoria, TX	05/14/2021			
The Knowledge Stack (The Knowledge Stack LLC)	Los Angeles, CA	05/14/2021			
The Kovacs Group	New Braunfels, TX	05/14/2021			
The MINT National Bank	Kingwood, TX	05/14/2021			
The National Behavioral Intervention Team Association	King of Prussia, PA	05/14/2021			
The Ombudsmen Group	Cibolo, TX	05/14/2021			
The Outreach Program Education/Counseling Services	Houston, TX	05/14/2021			
The Paper Plate, Inc	Dallas, TX	05/14/2021			
The Parent Coach	HOUSTON, TX	05/14/2021			
The Platform	Houston, TX	05/14/2021			
The Process Manager (Meliton Moya, Ph.D.)	Edinburg, TX	05/14/2021			
The Resilient Group	Houston, TX	05/14/2021			
The Schlueter Group (Stan Schlueter)	Austin, TX	05/14/2021			
The Style Signature	Carrollton, TX	05/14/2021			
The TEAMS Group, LLC	Austin, TX	05/14/2021			
The Trade Group	Carrollton, TX	05/14/2021			
The Yates Company	Houston, TX	05/14/2021			
TheDataFyles	Bellaire, TX	05/14/2021			
Therapy Consultants (MedPerm Placement Inc)	Houston, TX	05/14/2021			
Theresa Harris	HOUSTON, TX	05/14/2021			
thinkLaw (CS Educational Services, LLC)	Las Vegas, NV	05/14/2021			
Thomas Educational Solutions	Pearland, TX	05/14/2021	No Bid	05/18/2021	05/18/2021
Thompson & Horton LLP	Houston, TX	05/14/2021			
Thompson Educational Consulting, Inc.	Missouri City, TX	05/14/2021			
Tier One Learning, LLC	Sugar Land, TX	05/14/2021			
Timothy Project: Youth Mentoring Youth, Inc.	Houston, TX	05/14/2021			
TinMan Enterprises (TX TinMan Enterprises, LLC)	Fort Worth, TX	05/14/2021			
Tiphany Chambers Burrell	HOUSTON, TX	05/14/2021			
TISOMO Consulting Group, LLC	Jacksonville, FL	05/14/2021			
TLE Inc (The Look Enterprises, Inc.)	Bellaire, TX	05/14/2021			
TMI Solutions, LLC	George West, TX	05/14/2021			
TNR Accounting & Management Consulting, LLC (Nannette Ray)	Katy, TX	05/14/2021			
TNTP (The New Teacher Project, Inc.)	Brooklyn, NY	05/14/2021			
Total Administrative Services Corporation	Madsion, WI	05/14/2021			
Total Special Education Solutions, LLC	Beaumont, TX	05/14/2021			
TPR Education LLC (The Princeton Review)	Natick, MA	05/14/2021			
Trace3, Inc.	Irvine, CA	05/14/2021			
Transaption	Wilmington, DE	05/14/2021			
Transformation7 by Tiffany A. Washington	Houston, TX	05/14/2021			
Translation & Interpretation Network (Catholic Charities Diocese of Fort Worth, Inc. d/b/a Translation & Interpretation Network)	Fort Worth, TX	05/14/2021			
TransLinguist Translation & Document Clearing LLC	Dubai,	05/14/2021			
Trezvant Academy, Inc	Houston, TX	05/14/2021			
Trinity Review Services Inc	Houston, TX	05/14/2021			
True Love Childcare	Humble, TX	05/14/2021			
Trustmark National Bank	Jackson, MS	05/14/2021			
TSC COGIC	houston, TX	05/14/2021			
TSG Industries (The Sithe Group, LLC.)	Houston, TX	05/14/2021			
Tutor Doctor	Navasota, TX	05/14/2021			
Tynker	Mountain View, CA	05/14/2021			
U. S. WHOLESALE PRODUCTS	SAN ANTONIO, TX	05/14/2021			
U.S. Dream Academy, Inc	Columbia, PA	05/14/2021			
U-Bridge Project Consulting, LLC	Sugarland, TX	05/14/2021			
UNICOM Government, Inc. F/K/A GTSI Corp.	Chantilly, VA	05/14/2021			
Unified Sunergy Systems LLC	Flower Mound, TX	05/14/2021			
Unlimited Visions Aftercare, Inc	Houston, TX	05/14/2021			

UNTAPPED Genius	Missouri City, TX	05/14/2021		
UP Educational Consulting	Conroe, TX	05/14/2021		
US Executive LLC	Tampa, FL	05/14/2021		
Uturn Concepts Inc	Houston, TX	05/14/2021		
Vanguard Trading & Services, LLC	Houston, TX	05/14/2021		
VantagePoint Benefits (J. Peat & Associates)	Lynbrook, NY	05/14/2021		
Velvet Rope Experience (VRE Business Soutlions)	Houston, TX	05/14/2021		
Victory Group	Houston, TX	05/14/2021		
Vinnove Consulting Group	San Antonio, TX	05/14/2021		
Virtuo Group Corporation	The Woodlands, TX	05/14/2021		
Visual Communication Services (Webbco Enterprises, LLC)	Houston, TX	05/14/2021		
Vollitiion IIT Inc	ASHBURN, VA	05/14/2021		
VOX Global	Dallas, TX	05/14/2021		
VRJ & Associates, LLC	Sugar Land, TX	05/14/2021		
Waits Consulting Group	Houston, TX	05/14/2021		
Walk the Walk Promotions	Richardson, TX	05/14/2021		
Walker Quality Services	Cypress, TX	05/14/2021		
Walsh Gallegos Treviño Russo & Kyle P.C.	Austin, TX	05/14/2021	Viewed	05/14/2021
WaterLily Writing, LLC	Arlington, TX	05/14/2021		
Watkins & Associates Consulting Services LLC.	Houston, TX	05/14/2021		
Weaver	Houston, TX	05/14/2021		
Weaver and Tidwell, LLP	Houston, TX	05/14/2021		
Wellesley College	Wellesley, MA	05/14/2021		
Wells Fargo Bank NA	Minneapolis, MN	05/14/2021		
Wells Fargo Bank. NA	Houston, TX	05/14/2021		
Wellspring Family & Community Institute	Houston, TX	05/14/2021		
Wendy Perry Coparenting Education (www.wendyperry.com)	Watauga, TX	05/14/2021		
Westat	San Antonio, TX	05/14/2021		
Whitley Penn	Houston, TX	05/14/2021		
Willdan Engineering	Anaheim, CA	05/14/2021		
Williams Education Consulting	Houston, TX	05/14/2021		
Workshop Houston	Houston, TX	05/14/2021		
Wright One Training	Flower Mound, TX	05/14/2021		
Writers in the Schools	Houston, TX	05/14/2021		
Writing with Design (The Learning Project)	Norman, OK	05/14/2021		
WRM Development	Selma, TX	05/14/2021		
Wylie Construction Services	Humble, TX	05/14/2021	Viewed	05/20/2021
Yolah - Yolandra Drake	Houston, TX	05/14/2021		
Young Women Christian Association of Houston	Houston, TX	05/14/2021		
Your Pro Medical Inc. (Your Pro Consultant Inc.)	Bedford, TX	05/14/2021		
Youth Advocacy TEAM	Houston, TX	05/14/2021		
Youth Debate League (MDG Gulf Coast, LLC)	Missouri City, TX	05/14/2021		
Z Smart, LLC	Rockwall, TX	05/14/2021		
Zenith Designs, LLC	Houston, TX	05/14/2021		
ZNA DESIGN (ZNA GROUP LLC)	Katy, TX	05/14/2021		
ZolonTech, Inc.	Herndon, VA	05/14/2021		

## External Invitations

Invite Email	Auto Approve	Invitation Date	Status	Status Date
Alix.Cethoute@UMB.com	No	05/14/2021	Invitation Sent	05/14/2021
amattson@bokf.com	No	05/14/2021	Invitation Sent	05/14/2021
bcolon@rwbaird.com	No	05/14/2021	Invitation Sent	05/14/2021
bshiels@gobaker.com	No	05/14/2021	Invitation Sent	05/14/2021
Clarence.Grier@rbccm.com	No	05/14/2021	Invitation Sent	05/14/2021
cwhitlock@samcocapital.com	No	05/14/2021	Invitation Sent	05/14/2021
Darci.Doneff@psc.com	No	05/14/2021	Invitation Sent	05/14/2021
david.cisarik@fhnfinancial.com	No	05/14/2021	Invitation Sent	05/14/2021
debi.jones@raymondjames.com	No	05/14/2021	Invitation Sent	05/14/2021
don@ehmuni.com	No	05/14/2021	Invitation Sent	05/14/2021
dwesterman@samcocapital.com	No	05/14/2021	Invitation Sent	05/14/2021
frank.reed@ubs.com	No	05/14/2021	Invitation Sent	05/14/2021
kellyd@ms.com	No	05/14/2021	Invitation Sent	05/14/2021

lisa.donnely@raymondjames.com	No	05/14/2021	Invitation Sent	05/14/2021
mark.pryce@citi.com	No	05/14/2021	Invitation Sent	05/14/2021
Mason.McWilliams@fhnfinancial.com	No	05/14/2021	Invitation Sent	05/14/2021
megan.sienty@hilltopsecurities.com	No	05/14/2021	Invitation Sent	05/14/2021
mike.weir@amegybank.com	No	05/14/2021	Invitation Sent	05/14/2021

---

## Participant Detail

### @RISK Technologies

---

Address 16400 N. Dallas Pkwy Unit 105 Participation Type: Active Supplier  
Dallas, TX 75248

Invitation Date 05/14/2021  
Invitation Type Automatic  
Invitation Email(s)

### 2 Inspire Peace

---

Address 1808 S. Good Latimer Expressway Participation Type: Active Supplier  
Dallas, TX 75226

Classifications MBE (Primary),SBE,WBE

Invitation Date 05/14/2021  
Invitation Type Automatic  
Invitation Email(s) 2inspirepeace@gmail.com

### 2\*2\*4 Solutions Education Consulting Service

---

Address PO Box 2204 Participation Type: Active Supplier  
Red Oak, TX 75154

Invitation Date 05/14/2021  
Invitation Type Automatic  
Invitation Email(s) solution224@outlook.com

### 365 Media (365 Media LLC)

---

Address 59 Deer St #517 Participation Type: Active Supplier  
Portsmouth, NH 03801

Invitation Date 05/14/2021  
Invitation Type Automatic  
Invitation Email(s) donpaulwrites@gmail.com

### 365 Paving & Construction LLC

---

Address 1618 E. Griffin Parkway Participation Type: Active Supplier  
Mission, TX 78572

Invitation Date 05/14/2021  
Invitation Type Automatic  
Invitation Email(s) 365paving@gmail.com

### 3rd I Process FX

---

Address 4007 Floyd St. Participation Type: Active Supplier  
Houston, TX 77007

Invitation Date 05/14/2021  
Invitation Type Automatic  
Invitation Email(s) gmitchell@3rdiprocurement.com

### 4.0 GPA

---

Address P.O Box 940514 Participation Type: Active Supplier  
Houston, TX 77094

Invitation Date 05/14/2021  
Invitation Type Automatic  
Invitation Email(s) keculah@40gpa.com



**Harris County Department of Education  
Business Office /Purchasing Division  
Job (Bid-Proposal) Recommendation Form  
Program Review**

[This form is used to document due diligence by Recommendation Committee]

**To: Purchasing Division**

**From: Recommendation Committee**

**Dr. Jesus Amezcua  
Danielle Bartz  
Sarah Langlois  
Rosa Maria Torres**

*[Handwritten signatures in blue ink over horizontal lines]*  
Rosa Torres (Jul 7, 2021 11:03 CDT)

Job (Bid or RFQ#) and Name: 21/052KJ Bond Counsel Services for Harris County Department of Education and HCDE's Public Facility Corporation

Board Meeting Date: July 21, 2021

Date: July 7, 2021

**Procurement Requirements Available:**

Check One

- Under \$2,500 (Requires Division Director and Asst Supt. Approval)
- From \$2,500 to \$25,000 (Requires Buyer, Purchasing Director/CFO Approval)
- Over \$50,000 (Requires Board Approval)

I certify that I have reviewed the attached Job (bid, RFQ, RFP) and certify that all of my actions as a Recommendations Committee Member are within the procurement requirements in accordance with local Board Policies (CH local/legal) and legal (federal and state) policies and administrative guidelines set by the Business Office and Purchasing Division.

I certify that I have adhered to the Purchasing Policies of HCDE concerning the review of this job (bid or RFP) to include policies on conflict of interest (CIQ).

I certify that I am aware of all purchasing policies (CH Local and CH Legal) and administrative procedures of HCDE.

I certify that I am aware of the penalties of not following the purchasing policies and procedures and in specific with section 44.032 of the Texas Education Code which deals with the penalties related to sequential or component purchases.

I further certify that I recommend the issuance of a purchase order after Board approval and execution of a contract.









# HCDE RFQ 21 052KJ Bond Counsel Svcs PFC 7.7.21

Final Audit Report

2021-07-07

Created:	2021-07-07
By:	Jessica Bermea (jbermea@hcde-texas.org)
Status:	Signed
Transaction ID:	CBJCHBCAABAA7vxdVNIRb0vTtS_VZAv6qy2t4em--024

## "HCDE RFQ 21 052KJ Bond Counsel Svcs PFC 7.7.21" History

-  Document created by Jessica Bermea (jbermea@hcde-texas.org)  
2021-07-07 - 9:10:38 PM GMT- IP address: 170.39.204.253
-  Document emailed to Sarah Langlois (slanglois@kbslawgroup.com) for signature  
2021-07-07 - 9:11:07 PM GMT
-  Email viewed by Sarah Langlois (slanglois@kbslawgroup.com)  
2021-07-07 - 9:57:15 PM GMT- IP address: 216.201.148.122
-  Document e-signed by Sarah Langlois (slanglois@kbslawgroup.com)  
Signature Date: 2021-07-07 - 9:57:21 PM GMT - Time Source: server- IP address: 216.201.148.122
-  Document emailed to Rosa Torres (rosamtorres@hcde-texas.org) for signature  
2021-07-07 - 9:57:23 PM GMT
-  Email viewed by Rosa Torres (rosamtorres@hcde-texas.org)  
2021-07-07 - 10:01:50 PM GMT- IP address: 172.58.97.224
-  Document e-signed by Rosa Torres (rosamtorres@hcde-texas.org)  
Signature Date: 2021-07-07 - 10:03:30 PM GMT - Time Source: server- IP address: 172.58.97.224
-  Agreement completed.  
2021-07-07 - 10:03:30 PM GMT

**A RESOLUTION APPROVING ENGAGEMENT AGREEMENT FOR BOND COUNSEL AND APPROVAL OF OTHER MATTERS IN CONNECTION THEREWITH**

WHEREAS, the Harris County Department of Education (the “Issuer”) is considering issuing bonds or other obligations (“Bonds”) to pay the costs of one or more projects of the Issuer or the issuer’s public facilities corporation;

WHEREAS, the Board of Trustees of the Issuer (the “Board”) has determined that the Issuer should engage legal counsel that specializes in public finance and is well versed in federal tax law and federal securities law to provide bond counsel services to the Issuer in connection with the issuance of the Bonds;

WHEREAS, in this regard, the Board wishes to engage Orrick, Herrington & Sutcliffe LLP to provide bond counsel services pursuant to an engagement letter which includes a contingent fee payment provision under which payment of the fees for bond counsel shall be made at or immediately after the closing of the transaction for the issuance of the Bonds out of the proceeds of the Bonds; and

WHEREAS, pursuant to Section 2254.1036, Texas Government Code, the Issuer provided written notice to the public of the pendency of such contract, a copy of which is attached hereto as **Exhibit A** (the “Public Notice”).

NOW, THEREFORE, BE IT RESOLVED BY THE BOARD OF TRUSTEES OF THE HARRIS COUNTY DEPARTMENT OF EDUCATION THAT:

1. The recitals made in the Public Notice attached hereto as **Exhibit A** are hereby found to be true and are adopted as the findings of the Board.
2. The Board hereby further finds and declares: (i) there is a substantial need for the legal services to be provided by Orrick Herrington & Sutcliffe LLP; (ii) such legal services cannot be adequately performed by the attorneys and supporting personnel of the Issuer; and (iii) the legal services cannot reasonably be obtained from attorneys in private practice under a contract providing only for the payment of hourly fees, without regard to the outcome of the matter, because of the nature of the matter for which the services will be obtained and/or because the Issuer does not have funds to pay the estimated amounts required under a contract providing only for the payment of hourly fees.
3. Based on the foregoing, the Board hereby approves the Issuer entering into an engagement letter with a contingent fee payment provision with Orrick Herrington & Sutcliffe LLP in substantially the form presented to the Board, and authorizes the President of the Board of Trustees or such person’s designee, on behalf of the Issuer, to execute and deliver such engagement letter.
4. It is officially found, determined and declared that the meeting at which this resolution was adopted was open to the public and public notice of the time, place, and subject matter of this meeting and the notice required by Section 2254.1036, Texas Government Code, was given, all as required by Chapter 551, Texas Government Code.

5. This resolution shall be in force and effect from and after its final passage, and it is so resolved.

PASSED, ADOPTED AND APPROVED on this the 21st day of July, 2021.

HARRIS COUNTY DEPARTMENT OF EDUCATION

---

President

ATTEST:

---

Secretary

## Exhibit A

### PUBLIC NOTICE

At its meeting to be held at 6300 Irvington Boulevard in Houston, Texas on July 21, 2021, at 1:00 p.m., the Board of Trustees of the Harris County Department of Education (the "Issuer") will consider engaging Orrick Herrington Sutcliffe LLP ("Orrick") as bond counsel in connection with issuances of bonds or other obligations of the Issuer and the Issuer's public facilities corporation ("Bonds").

Pursuant to Section 2254.1036, Texas Government Code, the following written notice is given to the public:

1. The reason for pursuing issuance of Bonds (the matter that is the subject of the legal services for which Orrick would be retained) is to finance one or more projects or infrastructure improvements of the Issuer. The desired outcome of the matter is to issue Bonds in accordance with state, federal tax and securities law.
2. Orrick is a nationally recognized bond counsel firm specializing in the field of municipal finance law and it is among the largest municipal finance law firms in the nation. Orrick has advised thousands of clients on federal securities and tax matters in connection with the issuance of bonds and otherwise.
3. Orrick has previously served as Bond Counsel to the Issuer and the Issuer's public facilities corporation.
4. The Issuer does not have attorneys and/or supporting personnel who can perform this legal work.
5. The Issuer cannot reasonably engage attorneys for bond counsel services under hourly fee contracts without contingency because then the Issuer would have to pay such bond counsel fees from the Issuer's unrestricted general funds or, if any, other legally available funds, regardless of whether the Bonds are successfully issued, and such funds are limited and needed for other uses.
6. Contingency fee payment arrangements for bond counsel services would be in the best interest of the residents of the Issuer because the fees are fixed and only become due and payable when Bonds are successfully issued.

I hereby certify that the above public notice of Harris County Department of Education was posted in accordance with the Texas Open Meetings Act (Chapter 551 of the Texas Government Code) on or before July 17, 2021.

---

Authorized Representative of the Issuer



**Regular Board Meeting**

**8.F.7.**

**Meeting Date:** July 21, 2021

**Title:** Contract Award for Job No. 21/053KJ Financial Advisory Services for Harris County Department of Education and HCDE's Public Facility Corporation

**Submitted For:** Kendra Jackson, Purchasing

**Submitted By:** Kendra Jackson

**Recommended Action:** Approve

**HCDE Goal(s):** 2. Deliver value responsibly

**Additional Resource Personnel:** Dr. Jesus Amezcua, Kendra Jackson

**Facilities/Technology Approval Needed?:**

**Information**

**Posted Agenda Item:**

**Approval of Contract Award for pool of vendors for job no. 21/053KJ Financial Advisory Services for Harris County Department of Education and HCDE's Public Facility Corporation with the following proposer(s):** U.S. Capital Advisors, LLC, Estrada Hinojosa & Company, Inc., Hilltop Securities, Inc., Masterson Advisors, LLC, Stifel, Nicolaus & Company, Inc., and Tijerina Galvan Lawrence, LLC, for the period of 07/21/2021 through 07/20/2026, and approval of U.S. Capital Advisors, LLC to serve as HCDE and HCDE PFC's Primary Financial Advisor and the remaining firms as Secondary Financial Advisors, subject to annual appropriations of funding.

**Subject:**

Financial Advisory Services

**Rationale:**

The process enacted was a Request for Qualifications (RFQ) to acquire proposals from vendors for Financial Advisory Services for Harris County Department of Education and HCDE's Public Facility Corporation. One thousand and seven (1007) invitations were extended for proposals. Six (6) responses were received from vendors. Each response was reviewed for compliance with the requirements of the RFQ, evaluated, and scored. Six vendors offering the best value to HCDE was recommended for an award. The Initial Term of the prospective contract is a period of five (5) years to the vendors stated above in Posted Agenda Item; subject to annual appropriations of funding. The Department may elect, with mutual agreement of the awarded vendor, to extend any contract awarded pursuant to this procurement solicitation for up to two (2) additional five-year terms (individually, a "Renewal Term"). The maximum duration of any contract resulting from this procurement is a total of fifteen (15) years, running from the date of execution of the contract by the authorized representative of the Department. Contracts are in accordance with Texas Education Code Section 44.031(f) and the Professional Services Procurement Act, Chapter 2254 of the Texas Government Code.

**Fiscal Impact**

**Attachments**

- EC Form
- Evaluation Summary
- Participation Detail
- Financial Advisory

**Form Review**

**Inbox**  
Purchasing

**Reviewed By**  
Kendra Jackson

**Date**  
07/07/2021 04:17 PM



**Harris County Department of Education  
Business Office /Purchasing Division**

**EC Form**

**Effectiveness and Compliance Review**

[This form is used to document due diligence by Buyer]

---

To: Purchasing Audit File and Jesus J. Amezcua, Ph.D., CPA, Assistant Supt. for Business

From: Kendra Jackson – Director of Purchasing

Job- Bid or RFQ# and Name: 21/053KJ Financial Advisory Services for Harris County Department of Education and HCDE's Public Facility Corporation

Board Meeting Date: July 21, 2021

Date: July 7, 2021

**Procurement Requirements Applicable:**

Check One

- Under \$2,500 (Requires Division Director and Asst Supt. Approval)
- From \$2,500 to \$49,999 (Requires Buyer, Purchasing Director/CFO Approval)
- Over \$50,000 (per CH Local)
- Cooperative Programs (Requires Board Approval)

I certify that I have reviewed the attached job (bid or RFQ) and certify that all of my actions as a Recommendations Committee Member are within the procurement requirements in accordance with local Board Policies (CH local/legal) and legal (federal and state) policies and administrative guidelines set by the Business Office and the Purchasing Division.

I certify that I have adhered to the Purchasing Policies of HCDE concerning the review of this job (bid or RFQ) to include policies on conflict of interest.

I certify that I am aware of all purchasing policies (CH Local and CH Legal) and administrative procedures of HCDE.

I certify that I am aware of the penalties of not following the purchasing policies and procedures and in specific with section 44.032 of the Texas Education Code which deals with the penalties related to sequential or component purchases.

I further certify that I recommend the issuance of a purchase order after Board approval and execution of a contract.

(Note: This form is required of all jobs (bids and RFQs) prepared by all buyers and Director)

<b>Evaluation Summary - Job no. 21/053KJ - Financial Advisory Services for Harris County Department of Education and HCDE's Public Facility Corporation</b>	<b>Weighted Valued</b>	<b>US CAPITAL ADVISORS LLC</b>	<b>Estrada Hinojosa &amp; Company, Inc.</b>	<b>Hilltop Securities Inc.</b>	<b>Masterson Advisors LLC</b>	<b>Stifel, Nicolaus &amp; Company, Inc</b>	<b>Tijerina Galvan Lawrence LLC</b>
1. Bond Counsel experience in Texas public schools	15	15.00	13.75	15.00	13.00	11.50	12.50
2. Bond Counsel experience in governmental entities	10	9.75	7.00	10.00	6.25	8.00	4.75
3. Size/structure of the firm, including staff positions	20	20.00	16.00	18.00	14.50	13.00	15.25
4. Qualifications of supervisory personnel, consultants, and the team; education, including continuing education courses taken during the past two years; and years and type of experience	45	44.75	41.50	41.75	33.75	37.00	37.25
5. General direction and supervision to be exercised over the team by the firm's management personnel	5	5.00	4.75	4.75	4.50	3.75	4.00
6. Clear understanding of the work to be performed; comprehensiveness of the proposal	5	5.00	5.00	5.00	5.00	5.00	5.00
7. Total long-term cost to HCDE to acquire Vendor's goods and/or services	0	0.00	0.00	0.00	0.00	0.00	0.00
8. For a contract for goods and services, other than goods and services related to telecommunications and information services, building construction and maintenance, or instructional materials, whether the Consultant or the Consultant's ultimate parent company or majority owner: (A) has its principal place of business in this state; or (B) employs at least 500 persons in this state	0	0.00	0.00	0.00	0.00	0.00	0.00
9. Other (Previous Work with Governmental Agency)	0	0.00	0.00	0.00	0.00	0.00	0.00
<b>Total</b>	<b>100</b>	<b>99.50</b>	<b>88.00</b>	<b>94.50</b>	<b>77.00</b>	<b>78.25</b>	<b>78.75</b>
		<b>Award</b>	<b>Award</b>	<b>Award</b>	<b>Award</b>	<b>Award</b>	<b>Award</b>
		Primary	Secondary	Secondary	Secondary	Secondary	Secondary

# Harris County Department of Education

## Participation Detail as of 7/7/2021 03:54:17 PM (CT)

### Bid Information

Bid Creator Kendra Jackson Assistant Director  
 Email kjackson@hcde-texas.org  
 Phone (713) 696-0744  
 Fax (713) 696-0720  
  
 Bid Number 21/053KJ  
 Title Financial Advisory Services  
 Bid Type Request for Qualifications  
 Issue Date 5/14/2021 11:21 AM (CT)  
 Close Date 6/1/2021 02:00:00 PM (CT)

### Participation Summary

Company Name	City, State	Invitation Date	Status	Status Date	Response Date
@RISK Technologies	Dallas, TX	05/14/2021			
2 Inspire Peace	Dallas, TX	05/14/2021			
2*2*4 Solutions Education Consulting Service	Red Oak, TX	05/14/2021			
365 Media (365 Media LLC)	Portsmouth, NH	05/14/2021			
365 Paving & Construction LLC	Mission, TX	05/14/2021			
3rd I Process FX	Houston, TX	05/14/2021			
4.0 GPA	Houston, TX	05/14/2021			
4kboards	Keller, TX	05/14/2021			
4W Solutions, Inc	Houston, TX	05/14/2021			
7Mindsets	Roswell, GA	05/14/2021			
806 Technologies, Inc.	Plano, TX	05/14/2021			
A & R Holdings, LLC	Jacksonville, FL	05/14/2021			
A Better Resolutions, LLC	Houston, TX	05/14/2021			
A,N,H. Consulting, LLC.	New Orleans, LA	05/14/2021			
A.I.M. (Assessment Intervention Management, LLC)	San Antonio, TX	05/14/2021			
AAA Painting	Houston, TX	05/14/2021			
ABS (RJ Braniff Corporation)	Houston, TX	05/14/2021			
Abundance Educational Consulting, LLC	Humble, TX	05/14/2021			
AC Language School (Chavez & Associates)	Sugar Land, TX	05/14/2021			
Academic Learning Company (Velazquez Press)	El Monte, CA	05/14/2021			
Aceves Communications	Houston, TX	05/14/2021			
ACFS Security, LLC	Katy, TX	05/14/2021			
Achor Counseling & Associates LLC	HOUSTON, TX	05/14/2021			
ACS Engineering & Safety	Spring, TX	05/14/2021			
Acumen Enterprises, Inc.	Desoto, TX	05/14/2021			
AdaptiveX (Test4Me LLC)	Glenarden, MD	05/14/2021			
Adele's Coaching and Consulting	Missouri City, TX	05/14/2021			
Adira LLC	Savannah, TX	05/14/2021			
AdjuStar Services, Inc.	Houston, TX	05/14/2021			
ADMORE BEHAVIORAL THERAPY	Houston, TX	05/14/2021			
ADP, Inc.	Houston, TX	05/14/2021			
Adrian Garcia	Brownsville, TX	05/14/2021			
Advance Plus Therapy Services, LLC	Pasadena, TX	05/14/2021			
Advance Professional Consultants, LLC	Houston, TX	05/14/2021			
ADVANTAGE BENEFIT SOLUTIONS (Stefanick Insurance Services Inc.)	Houston, TX	05/14/2021			
Adwebvertising, LLC (Nick Covanes)	Katy, TX	05/14/2021			
AECOM (AECOM Technical Services Inc)	Houston, TX	05/14/2021			
Agular Systems, Inc.	Austin, TX	05/14/2021			
Agundez Inc, DBA Central Graphics	Houston, TX	05/14/2021			
Ajg	League city, TX	05/14/2021			
Alamo HR	San Antonio, TX	05/14/2021			
Alamo Music Center, Inc.	San Antonio, TX	05/14/2021			
Alba Educational Consulting, LLC	Kingwood, TX	05/14/2021			

Albert Johnson III, Inc.	Pearland, TX	05/14/2021
Albom Translation Services (Albom & Associates, LLC)	Arlington, VA	05/14/2021
Alegna Technologies, Inc.	Kennesaw, GA	05/14/2021
ALIrving Enterprises LLC	San Antonio, TX	05/14/2021
ALL AMERICAN SPECIALTY CONSTRUCTION LLC	IRVING, TX	05/14/2021
All Educate Learning Resources	Livingston, TX	05/14/2021
ALL VALLEY DRUG SCREENS	Brownsville, TX	05/14/2021
Alliance Financial Ministries, Inc.	Pearland, TX	05/14/2021
Allovue	Baltimore, MD	05/14/2021
ALPHA Facilities Solutions	San Antonio, TX	05/14/2021
AlphaGraphics (Lukitas Inc.)	Houston, TX	05/14/2021
ALTERING THE EDUCATION XPECTATION LLC	Evanston, IL	05/14/2021
Altitude Learning (AltSchool, PBC d/b/a Altitude Learning)	San Francisco, CA	05/14/2021
Amaanah Refugee Services	Houston, TX	05/14/2021
aMaezing Marketing Group dba Stryker-Munley Group (aMAEZing Marketing Group)	San Antonio, TX	05/14/2021
Amanda Holdsworth Communications	South Lyon, MI	05/14/2021
American Fire Systems Inc.	HOUSTON, TX	05/14/2021
American Productivity & Quality Center	Houston, TX	05/14/2021
American Vision Marketing LLC	Stafford, TX	05/14/2021
Amparo Consulting & Design	Grand Junction, CO	05/14/2021
AMTEX Security Inc.	Corpus Christi, TX	05/14/2021
Anew Psychological Services, PLLC	Houston, TX	05/14/2021
AnLar, LLC	Arlington, VA	05/14/2021
Ann Marie Harbour	Richmond, TX	05/14/2021
Antonia Y. Hamm	Humble, TX	05/14/2021
APIA Source (APIA Source LLC)	Saginaw, TX	05/14/2021
Apple Developmental Health	Houston, TX	05/14/2021
Applications Software Technology Corporation	Naperville, IL	05/14/2021
Aptim Environmental & Infrastructure	Baton Rouge, LA	05/14/2021
Arctic Information Technology, Inc.	Anchorage, AK	05/14/2021
ardurra group	houston, TX	05/14/2021
Argument-Driven Inquiry	Austin, TX	05/14/2021
ARMI Consulting (Account Receivable Management, Inc.)	Orlando, FL	05/14/2021
ARRAY	Bellaire, TX	05/14/2021
Arthur J Gallagher, Inc.	Huntington Beach, CA	05/14/2021
Arts Alive! Inc (ARTS ALIVE!)	Houston, TX	05/14/2021
As We Grow Learning Center	Houston, TX	05/14/2021
ASA Builders, Inc	pasadena, TX	05/14/2021
ASAP Business Services (Accurate Standards Available Professionals Business Services, LLC)	Houston, TX	05/14/2021
ASAP Roofing (Koppel & Kozel, LLC)	Tyler, TX	05/14/2021
ASD Consultants, Inc.	Austin, TX	05/14/2021
Ashita.Design, LLC	Humble, TX	05/14/2021
ASmart Consulting	Houston, TX	05/14/2021
Aspell Services, Inc.	SAN ANTONIO, TX	05/14/2021
Aspire Works LLC	San Antonio, TX	05/14/2021
Assoc for the Advancement of Mexican Americans (AAMA)	Houston, TX	05/14/2021
Astrov & Associates	Frisco, TX	05/14/2021
AT&T Mobility LLC	Bellaire, TX	05/14/2021
Atkins Powerhouse Consulting LLC	Fort Worth, TX	05/14/2021
Atlas Civil Engineering PLLC	Houston, TX	05/14/2021
Audimation Services Inc	Houston, TX	05/14/2021
Auspicious Labs Inc. (same)	Houston, TX	05/14/2021
AUSTIN LEARNING CENTER (CANDEO, LLC)	AUSTIN, TX	05/14/2021
Automated Financial Systems (Robert Beyer Enterprises LLC)	San Antonio, TX	05/14/2021
Baked With Confidence	Houston, TX	05/14/2021
Balance Companies (Balance Group, LLC)	Houston, TX	05/14/2021
Bank of America N.A.	Houston, TX	05/14/2021
Bank of Texas (BOKF, NA)	Houston, TX	05/14/2021

Bara Infoware Inc.	Danville, CA	05/14/2021		
Barranco Educational Assessment, Counseling, and Consulting Svcs., PLLC	Montgomery, TX	05/14/2021		
Barstone, Inc.	San Antonio, TX	05/14/2021		
Battleground WTS	Houston, TX	05/14/2021		
BB&T	Winston Salem, NC	05/14/2021		
BBeauti AndLashes LLC	Houston, TX	05/14/2021		
BBVA Compass	Houston, TX	05/14/2021		
BCA DX LABORATORY	Livingston, TX	05/14/2021		
BCS Consulting	Humble, TX	05/14/2021		
BDK And Associates LLC	Colleyville, TX	05/14/2021		
BE GLAD LLC	San Jose, CA	05/14/2021		
BE Staffing Solutions LLC	Houston, TX	05/14/2021		
BEAL Safety and Performance	Sugar Land, TX	05/14/2021		
Bearing Fruit Early Childhood Training	HOUSTON, TX	05/14/2021		
Bedden & Associates, LLC (Bedden)	Richmond, VA	05/14/2021		
Bee Busy Wellness Center	Houston, TX	05/14/2021		
Bell and Smarts	Broken Arrow, OK	05/14/2021		
Belt Harris Pechacek	Houston, TX	05/14/2021		
BenCheri Educational Center	Houston, TX	05/14/2021		
BenefitScape (Benefit Coordinators of America, LLC)	Natick, MA	05/14/2021		
BENNETT MANAGEMENT SOLUTIONS LLC	Spring, TX	05/14/2021		
Best Lead Generation LLC	Conroe, TX	05/14/2021		
Best Practice Associates, Inc.	Houma, LA	05/14/2021		
BIAS Corporation	Atlanta, GA	05/14/2021		
Billtrust	Hamiton, NJ	05/14/2021		
Bio-Rad Laboratories, Inc	Hercules, CA	05/14/2021		
Black Topaz Consulting	Austin, TX	05/14/2021		
Black United Fund of Texas	Houston, TX	05/14/2021		
BlackBeltHelp	Chicago, IL	05/14/2021		
Blaylock Van, LLC	New York, NY	05/14/2021		
BLU PHIRE RESEARCH INSTITUTE INC	HOUSTON, TX	05/14/2021		
BluGreen Pest Control	Wallis, TX	05/14/2021		
BMHR - Better Man HR LLC	SAN ANTONIO, TX	05/14/2021		
BOLDplanning (BOLDplanning, inc)	Nashville, TN	05/14/2021		
Bond Program Management Services	Richards, TX	05/14/2021		
BookerDezigns	Richmond, TX	05/14/2021		
Bookwhisperer, Inc. (Donalyn Miller)	Colleyville, TX	05/14/2021		
Boundaryless Enterprises, LLC	Houston, TX	05/14/2021		
Bracane Company	Plano, TX	05/14/2021		
Brahmarsk Corporation	Sugar Land, TX	05/14/2021		
BrainStorm Advanced Learning Systems	Mansfield, TX	05/14/2021		
Brandi Spencer Consulting	Spring, TX	05/14/2021		
Brandi T. Brown	Manvel, TX	05/14/2021		
Braun Intertec Corporation	Houston, TX	05/14/2021		
BRB Supply	Houston, TX	05/14/2021		
Briar Patch	Houston, TX	05/14/2021		
Bridge to Leadership, LLC	Missouri City, TX	05/14/2021		
Bridgepoint Consulting, LLC	Austin, TX	05/14/2021		
Brighter Futures Counseling and Consulting	Houston, TX	05/14/2021		
Bruce Monical Design	Bacliff, TX	05/14/2021		
BTS Consulting (Business Trade and Services, inc.)	Doral, FL	05/14/2021		
Building Solutions	dallas, TX	05/14/2021		
Bureau of Education & Research	Bellevue, WA	05/14/2021		
Business & Financial Management Solutions, LLC	Austin, TX	05/14/2021		
BUSINESS 101 CONSULTANTS & TRAINERS	Houston, TX	05/14/2021		
C Change Consulting	Houston, TX	05/14/2021		
C1S Group, Inc.	Dallas, TX	05/14/2021		
Cadence Bank	houston, TX	05/14/2021	Viewed	05/21/2021
cain & co llc	Concord, TX	05/14/2021		
CALPAA Inc (CALPAA, Inc)	Seattle, WA	05/14/2021	Viewed	05/17/2021
Cam Light Enterprise Inc.	Conroe, TX	05/14/2021		
Camelback Displays Inc.	Spring, TX	05/14/2021		
Canyon Insurance Group	Houston, TX	05/14/2021		

Caperton-Brown & Poole Consulting	Ft. Pierce, FL	05/14/2021			
Capital One Bank	McLean, VA	05/14/2021	No Bid	05/14/2021	05/14/2021
Capitol Region Education Council	Hartford, CT	05/14/2021			
Career Resource Center	HUMBLE, TX	05/14/2021			
Carmen A. Handy	Corpus Christi, TX	05/14/2021			
Carol Cooper dba N&C Consulting	Garland, TX	05/14/2021			
Casablanca Productions	Spring, TX	05/14/2021			
Catapult Dreams, LLC	Pearland, TX	05/14/2021			
CBRE   Heery (CBRE Heery, Inc.)	Houston, TX	05/14/2021			
CBRE Valuation & Advisory Services	Houston, TX	05/14/2021			
CBTS Technology Solutions	Cincinnati, OH	05/14/2021			
CC Assessment Services, Inc	Houston, TX	05/14/2021			
CCS Global Tech (California Creative Solutions, Inc)	Poway, CA	05/14/2021			
CDR Maguire, Inc.	Miami, FL	05/14/2021			
CELLULAR WHOLESALERS, INC	Medley, FL	05/14/2021			
Center for Student Achievement Solutions	New York, NY	05/14/2021			
Center for Toxicology and Environmental Health, LLC.	North Little Rock, AR	05/14/2021			
Central IT Company LLC	Houston, TX	05/14/2021			
Certica Solutions	Wakefield, MA	05/14/2021			
CharacterStrong, LLC	PUYALLUP, WA	05/14/2021			
Charbonnet & Associates	New Orleans, LA	05/14/2021			
Chart Chicks LP	Lufkin, TX	05/14/2021			
Charter School Success, LLC	Galveston, TX	05/14/2021			
Chase in Dreams, Speech and Drama (Deadra Chase)	Houston, TX	05/14/2021			
CHAT (Culture of Health-Advancing Together)	Houston, TX	05/14/2021			
Chazey Partners (Chazey Partners Inc)	Campbell, CA	05/14/2021			
Cheryl R. Vital	Crosby, TX	05/14/2021			
Child Care Associates	FORT WORTH, TX	05/14/2021			
Child Champ Photography (Jody Goldstein)	Houston, TX	05/14/2021			
Childcare Masters LLC	Cypress, TX	05/14/2021			
Cindy Puryear Consulting Services (Cindy Puryear)	Houston, TX	05/14/2021			
Clark Hill Strasburger (Clark Hill PLC)	Houston, TX	05/14/2021			
Classware Systems (Classware L.P.)	Dallas, TX	05/14/2021			
cLI-Energy and Construction LL	Houston, TX	05/14/2021			
Clifton Gunderson LLP	Milwaukee, WI	05/14/2021			
Clinical Concepts! (The Entermedia Group, LLC)	Austin, TX	05/14/2021			
Club SciKidz Houston (Heir Consulting Group)	Houston, TX	05/14/2021			
Coaching Consultants Team	Houston, TX	05/14/2021			
Coatings Specialty Development Lab	Cypress, TX	05/14/2021			
Code Park Inc	Houston, TX	05/14/2021			
CohnReznick LLP	Austin, TX	05/14/2021			
Collaborate With Christina	Houston, TX	05/14/2021			
Color of Life (Color of Life Community Resource & Activity center)	Houston, TX	05/14/2021			
Comflow Mechanical Services	Houston, TX	05/14/2021			
Commerce Bank (Commerce Bancshares, Inc.)	Kansas City, TX	05/14/2021			
Communities In Schools of Houston (Communities In Schools of Houston, Inc.)	Houston, TX	05/14/2021			
Community Nutrition Outreach Services (Ellis A Morrow)	Houston, TX	05/14/2021			
Comprehensive Cloud Services	Houston, TX	05/14/2021			
CompuGroup Medical	Phoenix, AZ	05/14/2021			
Conscious Education Consulting, LLC.	Katy, TX	05/14/2021			
Consolidated Performance Consulting, LLC.	San Antonio, TX	05/14/2021			
Construction Journal	Stuart, FL	05/14/2021			
Control Systems Solutions, Inc.	Houston, TX	05/14/2021			
Convergent Nonprofit Solutions	Atlanta, GA	05/14/2021			
CoolSpeak, LLC	Pottstown, PA	05/14/2021			
Cooperative Strategies	Dublin, OH	05/14/2021			
Copy.com (Copydotcom, Inc.)	Houston, TX	05/14/2021			
CORE construction services of Texas, Inc.	Frisco, TX	05/14/2021			
Cossey's Services, LLC	The Woodlands, TX	05/14/2021			
Costello, Inc.	Houston, TX	05/14/2021			

Council Rock Enterprises, LLC	Rochester, NY	05/14/2021
Covid Safety Glass (Silent West LLC)	LAS VEGAS, NV	05/14/2021
CPS HR Consulting (Cooperative Personnel Services)	Sacramento, CA	05/14/2021
CRAFT SAFETY INSPECTIONS (JMAC GROUP LLC)	HOUSTON, TX	05/14/2021
Creative Circle, LLC	Los Angeles, CA	05/14/2021
Creative Financial Staffing Inc	Houston, TX	05/14/2021
Creatively Inspired Communications (ConSandra Jones)	Austin, TX	05/14/2021
CReed Global Enterprises (CReed Global Media & Production)	Houston, TX	05/14/2021
Crimson Vision Enterprises	Dickinson, TX	05/14/2021
Crowe LLP	Oakbrook Terrace, IL	05/14/2021
Crystal Clear Business Solutions	Sugar Land, TX	05/14/2021
CVS Pharmacy, Inc.	Woonsocket, RI	05/14/2021
Cyberstar, LLC	Austin, TX	05/14/2021
Cyclone FPV (Cyclone 3D, Inc.)	Spring, TX	05/14/2021
D&M Leasing (Commercial Vehicle Leasing, LP)	Fort Worth, TX	05/14/2021
D.A. Lamont Public Adjusters	Springtown, TX	05/14/2021
Daintree Solutions LLC	Richmond, TX	05/14/2021
Dalton Air Conditioning and Heating (Dalton Air Conditioning and Heating, LLC)	Pearland, TX	05/14/2021
Dan L. Duncan Tutoring a part of the Children's Learning Institute (University of Texas Health Science Center)	Houston, TX	05/14/2021
Dan St. Romain Educational Consulting, LLC	Universal City, TX	05/14/2021
Dana Lee	Texas City, TX	05/14/2021
Danny Steele (Daniel J. Steele)	Birmingham, AL	05/14/2021
Data Facts, Inc	Cordova, TX	05/14/2021
David James (David Hebert)	KEMAH, TX	05/14/2021
David Rodriguez	San Antonio, TX	05/14/2021
David Santana	Houston, TX	05/14/2021
David Webb	Pasadena, TX	05/14/2021
DB3 Unlimited Services LLC	San Antonio, TX	05/14/2021
dba Stenhouse Publishers and dba Staff Development for Educators (SDE, Inc.)	Portsmouth, NH	05/14/2021
Deacon Hill Research Associates LLC	Fredericksburg, VA	05/14/2021
Debbie J. Anders Consulting	Cypress, TX	05/14/2021
Decisions	Houston, TX	05/14/2021
DeDe Church & Associates, LLC	AUSTIN, TX	05/14/2021
Defined Learning	Northbrook, IL	05/14/2021
DEMS,LLC	Houston, TX	05/14/2021
Dennis Calloway	Houston, TX	05/14/2021
Designum Media Group	New Orleans, LA	05/14/2021
DG Grafix	Houston, TX	05/14/2021
DGR United	houston, TX	05/14/2021
Diamond Business Services, Inc.	Amarillo, TX	05/14/2021
DIBSYS Inc	Naperville, IL	05/14/2021
DigitalGenetix	San Antonio, TX	05/14/2021
Dillon Claims & Consulting Services LLC	gonzales, LA	05/14/2021
Disciplers Inc	Spring, TX	05/14/2021
DiscoverU	Houston, TX	05/14/2021
Diverse Consulting Enterprises, Inc.	HOUSTON, TX	05/14/2021
Divine Dance (Peaceful Beginnings Montessori)	houston, TX	05/14/2021
DK High Steppers (Doris Keener)	Houston, TX	05/14/2021
DMS Disaster Consultants	Boca Raton, FL	05/14/2021
Doherty and Associates Inc.	Wilmington, DE	05/14/2021
DoLogic Inc.	Annandale, VA	05/14/2021
Doucet & Associates, Inc.	Austin, TX	05/14/2021
Dr. Jeanne M. Hines	Port Arthur, TX	05/14/2021
Dr. Ken Brumfield, Learning Empire	Santa Ana, CA	05/14/2021
Dr. Mary E. White International, LLC	Houston, TX	05/14/2021
Dr. Mike!	Wimberely, TX	05/14/2021
Dr. Pope's STEM and Liberal Arts Academy	Pearland, TX	05/14/2021
Dream Capital International, Inc	Houston, TX	05/14/2021
DYS HOUSYON YOUTH ASSOCIATION	Houston, TX	05/14/2021



E3 Alliance	Austin, TX	05/14/2021			
Earl P. Forbrich, Jr. Inc	San Antonio, TX	05/14/2021			
Early Start Development Inc	Humble, TX	05/14/2021			
E-Colors in Education	Austin, TX	05/14/2021			
EDU Specialist, LLC	Lake Dallas, TX	05/14/2021			
Educate To Edify (Educating While Black)	Pearland, TX	05/14/2021			
Education & Business Associates, Inc.	DeSoto, TX	05/14/2021			
Education Partners Solution, Inc.	Sugar Land, TX	05/14/2021			
Education Solutions Now, LLC	Houston, TX	05/14/2021	No Bid	05/26/2021	05/26/2021
Educational Epiphany LLC	WASHINGTON, DC	05/14/2021			
Educational Leadership Consultants	Houston, TX	05/14/2021			
Educational Research and Consulting, PLLC (Cynthia H. Williams, PhD)	Little Rock, AR	05/14/2021			
Educational Systems Consulting	Binghamton, NY	05/14/2021			
Edwards Sutarwalla PLLC	Houston, TX	05/14/2021			
Eichelbaum Wardell Hansen Powell & Mehl,	Austin, TX	05/14/2021			
Elaine Lange	Austin, TX	05/14/2021			
Electric Car Insider (Christopher Alan Consulting)	Spring Valley, CA	05/14/2021			
Elegant Enterprise Wide Solutions, Inc.	Chantilly, VA	05/14/2021			
Elevated Insights	Colorado Springs, CO	05/14/2021			
Elisa Rankin Consulting LLC	Uvalde, TX	05/14/2021			
Elite Change Inc.	Houston, TX	05/14/2021			
Elite Image Tax & Notary Service LLC	Houston, TX	05/14/2021			
Ellington Chastain Educational Initiative	San Antonio, TX	05/14/2021			
E-Logic, Inc.	Washington, DC	05/14/2021			
Emdin Support Services LLC	Bronx, NY	05/14/2021			
Emergent Professional Resources LP	Houston, TX	05/14/2021			
Emergent Risk Solutions	BATON ROUGE, LA	05/14/2021			
Emergent Tree Education	Austin, TX	05/14/2021			
Emma Oliver	Houston, TX	05/14/2021			
empower retirement (great-west life and annuity)	greenwood village, CO	05/14/2021			
Empowered Network Services, LLC	Huffman, TX	05/14/2021			
Energard Technologies (Ontracor, Inc.)	Lynnwood, WA	05/14/2021			
Energy Saving Advisor Distributors	Dallas, TX	05/14/2021			
engage2learn (Engage! Learning, Inc. dba engage2learn)	Portland, TX	05/14/2021			
Enterprise Fleet Management, Inc.	St. Louis, MO	05/14/2021			
Enterprise Pals, Inc.	Olathe, KS	05/14/2021			
ENTRAM CORP	PORT CHARLOTTE, FL	05/14/2021			
Epic Decisions, LLC	Kingwood, TX	05/14/2021			
ERASCOGroup, LLC	Houston, TX	05/14/2021			
eRate 360 Solutions	Henderson, NV	05/14/2021			
E-Rate Elite Services, Inc.	Owings Mills, MD	05/14/2021			
Essential Wellness and Balance	Missouri City, TX	05/14/2021			
Estrada Hinojosa & Company, Inc.	Dallas, TX		Submitted	06/01/2021	06/01/2021
eTeachingMe (Love N Learn At Home)	Georgetown, TX	05/14/2021			
Eternal Media Solutions (Eternal Media Solutions LLC)	Katy, TX	05/14/2021			
Etrainers.org	Machesney Park, IL	05/14/2021			
Evergreen Solutions, LLC	Tallahassee, FL	05/14/2021			
Evolve Holdings Inc	Houston, TX	05/14/2021			
Ewing Strategic Communications	Houston, TX	05/14/2021			
Exceptional Pediatric Therapy, LLC	Houston, TX	05/14/2021			
ExecuTeam Staffing	Houston, TX	05/14/2021			
ExerPlay, Inc	Cedar Crest, NM	05/14/2021			
Exploros (Exploros, Inc.)	Wayland, MA	05/14/2021			
EXPRESSIONS PRODUCTIONS (1972)	Houston (and vicinity), TX	05/14/2021			
EY (Ernst & Young LLP)	Austin, TX	05/14/2021			
Facelift Graphics	Fresno, TX	05/14/2021			
FACILITIES INTEGRATED SOLUTIONS & CONSULTING LLC	CYPRESS, TX	05/14/2021			
Facility Engineering Associates, PC	Fairfax, VA	05/14/2021			
Faith Works Consulting Group, LLC	Houston, TX	05/14/2021			
Fannbassllc (Joseph Ball)	VA , Beach, VA	05/14/2021			
Fast Forward	Las Vegas, NV	05/14/2021			
FASTSIGNS 2073	GALVESTON, TX	05/14/2021			
Favor Consulting Inc (Demlan Solutions Inc)	Southlake, TX	05/14/2021			

Fazzio Consulting, LLC.	Round Rock, TX	05/14/2021		
Felicity Educational Services	Deerfield, IL	05/14/2021		
Ferrilli	Haddonfield, NJ	05/14/2021		
Finest Blood	Houston, TX	05/14/2021		
Fireworx International, LLC	Spring, TX	05/14/2021		
FIRST Educational Resources, LLC	Winneconne, WI	05/14/2021		
Floral Park Consulting LLC	Floral Park, NY	05/14/2021		
Foodservice Peeps LLC	Richmond, TX	05/14/2021		
For The Culture Literacy Development	Humble, TX	05/14/2021		
Forged Ed	Houston, TX	05/14/2021		
Fortify Experts, LLC (Energy Sourcing LLC)	Houston, TX	05/14/2021		
Foston International Communications Inc.	Richmond, TX	05/14/2021		
Frame-Work Consult	HOUSTON, TX	05/14/2021		
Franklin D Saulsberry LLC	Porter, TX		Viewed	05/20/2021
Freedom Profit Recovery (FPR Holdings, LP)	Irving, TX	05/14/2021		
Freese and Nichols, Inc.	Fort Worth, TX	05/14/2021		
Friends of the British Council USA Inc.	Washington, DC	05/14/2021		
From The Ground up Performance Enhancement (Deanna Voltz)	Houston, TX	05/14/2021		
From The Heart International Educational Services	Nashville, TN	05/14/2021		
FrontGate HR	Lubbock, TX	05/14/2021		
Frontier Services Group	Houston, TX	05/14/2021	Viewed	05/14/2021
Frost Bank	Dallas, TX	05/14/2021	Viewed	05/17/2021
Fullidity LLC	Houston, TX	05/14/2021		
Furness Law	Houston, TX	05/14/2021		
G S McCoy Inc PC	Houston, TX	05/14/2021		
G4C Enterprises, LLC	Pflugerville, TX	05/14/2021		
Gary Polland P.C.	Houston, TX	05/14/2021		
Garza/Gonzalez & Associates	San Antonio, TX	05/14/2021		
Gastile Consultant Group	Houston, TX	05/14/2021		
Gateway Solutions inc	overland park, KS	05/14/2021		
Gazelle Capital, LLC	Saint Petersburg, FL	05/14/2021		
Geaux Crates & Storage, LLC	Houston, TX, TX	05/14/2021		
Generation Ready	New York, NY	05/14/2021		
Generation Teach Inc.	Boston, MA	05/14/2021		
Gene's Machine, INC.	Victoria, TX	05/14/2021		
Gentle Minds Tutoring	Missouri City, TX	05/14/2021		
GermBlast (Infection Controls, Inc.)	Lubbock, TX	05/14/2021		
GET Technology and Accounting Solutions	Santo, TX	05/14/2021		
Getting Sorted (G. Yess Fisher & Co., LLC)	The Woodlands, TX	05/14/2021		
Gibson Consulting Group	Austin, TX	05/14/2021		
Gifting Grounds	Houston, TX	05/14/2021		
Gilberto D. Soto	Laredo, TX	05/14/2021		
GilCat Solutions (Gloria Lastra)	Spring, TX	05/14/2021		
Girlstart	Austin, TX	05/14/2021		
Glass View of Tech	Spring, TX	05/14/2021		
Global Education Systems Alliance (William H Prouty PhD)	Sun City, CA	05/14/2021		
GLOBAL EDUCATIONAL SOLUTIONS LLC	Canton, MI	05/14/2021		
GMC CONSULTANTS,LLC	Houston, TX	05/14/2021		
GMP Media Group	Atlanta, GA	05/14/2021		
GO M PAC	Houston, TX	05/14/2021		
GOD FEARING POWER HOUSE (POWER ROCK COMMUNITY CENTR)	HOUSTON, TX	05/14/2021		
Golden Mountain Consulting L.L.C	Houston, TX	05/14/2021		
Golding Touch Education Consul	Manvel, TX	05/14/2021		
GO-Strategic Management Services	Houston, TX	05/14/2021		
GovSense	Alpharetta, GA	05/14/2021		
GPR Ventures, LLC	Montgomery, TX	05/14/2021		
Gray Mechanical (Gray Mechanical, LLC)	Houston, TX	05/14/2021		
Gray Step Software	El Dorado Hills, CA	05/14/2021		
Gray&Pape, Inc.	Cincinnati, OH	05/14/2021		
Greatest in the Kingdom Ministries	The Woodlands, TX	05/14/2021		
Green Delete Inc.	Frankfort, IL	05/14/2021		
Greenberg Traurig LLP	Miami, FL	05/14/2021		
Grow Minds Consulting LLC	HOUSTON, TX	05/14/2021		

GT Educational Services (GT Educational Services, L.L.C.)	Houston, TX	05/14/2021			
GW Implementation Solutions	Nokomis, FL	05/14/2021			
H. J. DEBOER & ASSOCIATES	KINGWOOD, TX	05/14/2021			
Hagerty Consulting, Inc. (Freeman)	Evanston, IL	05/14/2021			
Hallmark Mitigation & Construction	Kingwood, TX	05/14/2021			
Happy Chapters, LLC	Austin, TX	05/14/2021			
Harmony Public Schools	Houston, TX	05/14/2021			
Harris County Houston Patrol, Inc.	Houston, TX	05/14/2021			
HARRIS-JONES STAFFING & RECRUITING	Katy, TX	05/14/2021			
Harvesting Wealth LLC	Houston, TX	05/14/2021			
Haude Tutoring	Spring, TX	05/14/2021			
Hayhouse Projects LLC	Brooklyn, NY	05/14/2021			
Hayley Wilson	Concord, NC	05/14/2021			
HCONE International IMPEX Inc (Enoch Kabutey)	Houston, PA	05/14/2021			
Healing Species of Texas	Montgomery, TX	05/14/2021			
Heart Nation Inc	Humble, TX	05/14/2021			
Heartwork Trending Counseling and Consulting, PLLC (Heartwork Trending Consulting Services)	Houston, TX	05/14/2021			
Heavenly Service, LLC	Webster, TX	05/14/2021			
Helping All Leaders Obtain Success (HALOS) (Helping All Leaders Obtain Success)	Homewood, IL	05/14/2021			
HENECO ENGINEERING AND CONSULTING	Houston, TX	05/14/2021			
Henry Deslaurier	Houston, TX	05/14/2021			
Hereford, Lynch, Sellars & Kirkham, P.C.	Cleveland, TX	05/14/2021			
Heritage Institute of Sustainability LLC	Dallas, TX	05/14/2021			
Herrera Talent Strategies LLC	Houston, TX	05/14/2021			
HillCo Partners, LLC	Austin, TX	05/14/2021			
Hilltop Securities Inc.	Dallas, TX		Submitted	06/01/2021	06/01/2021
HiMac Center for Creative Thinking	Humble, TX	05/14/2021			
HiTouch Business Services	LaVergne, TN	05/14/2021			
Hoensty Environmental Services	Houston, TX	05/14/2021			
Hogan's consulting (Deon I Hogan)	Pflugerville, TX	05/14/2021			
Holland Energy Consulting	Houston, TX	05/14/2021			
Holtz/Adams Construction and Consulting, LLC	Universal City, TX	05/14/2021			
Honesty Construction Group (HCG Management LLC)	Manvel, TX	05/14/2021			
Honor Moorman Consulting	Brazoria, TX	05/14/2021			
Hooper Strategies	Granbury, TX	05/14/2021			
Hope Over Hurt	Houston, TX	05/14/2021			
HORIZON SW PROPERTIES	SUGAR LAND, TX	05/14/2021			
Horn Solutions, Inc.	Sugar Land, TX	05/14/2021			
HORNE LLP	Austin, TX	05/14/2021			
Houston ISD - Medicaid Finance & Consulting Services	Houston, TX	05/14/2021			
Houston Modular Installation	Houston, TX	05/14/2021			
Houston Museum of Natural Science	Houston, TX	05/14/2021			
Houston Press, LP	Houston, TX	05/14/2021			
Houston Urban Debate League	Houston, TX	05/14/2021			
HR Best Practices (DIVA Solutions, LLC)	Franklin Lakes, NJ	05/14/2021			
HRchex, LLC (Intellisoft II, Inc.)	Irving, TX	05/14/2021			
HTEC-Houstons Training and Education Center, Inc. (Phillips)	Houston, TX	05/14/2021			
Hunt, Guillot & Associates	Baton Rouge, LA	05/14/2021			
Husch Blackwell LLP	Houston, TX	05/14/2021			
IA-Advanced Telecom Solutions, LLC	Richmond, TX	05/14/2021			
ICC Thermal Mapping and Data Analytcs (Infrared Concepts Corporation)	Maitland, FL	05/14/2021			
ID Media, Inc	Chicago, IL	05/14/2021			
IdentifIE Special Education, LLC	Houston, TX	05/14/2021			
IECGTX (Insurance Estimating & Consulting Group, LLC)	SPRINGTOWN, TX	05/14/2021			
Imagine Excellence.Inc	Houston, TX	05/14/2021			
Imagine Me Academy	Crosby, TX	05/14/2021			
Imbue Cleaning Solutions	Augusta, GA	05/14/2021			
IMPACT 360	Missouri City, TX	05/14/2021			
Imperium Risk	Lubbock, TX	05/14/2021			

IMS Dodge	San Diego, CA	05/14/2021		
Indatatech (Instant Data Technologies, Inc.)	San Antonio, TX	05/14/2021		
Independent Financial	McKinney, TX	05/14/2021		
Infinite Education Solutions	Desoto, TX	05/14/2021		
Infinite Solutions Enterprises (The DDance Group, Inc.)	Glen Allen, VA	05/14/2021		
Infojini, Inc.	Columbia, MD	05/14/2021		
Ink International	Lawrenceville, GA	05/14/2021		
InnerChange Consulting Group	Houston, TX	05/14/2021		
Innovation Bridge, Inc.	Sacramento, CA	05/14/2021		
Innovative Texas Strategies LLC	Houston, TX	05/14/2021		
InnovsiteLLC	Decatur, GA	05/14/2021		
Insight Investments, LLC	Costa Mesa, CA	05/14/2021		
Instead	Kingwood, TX	05/14/2021		
Institute for Building Technology and Safety	VA, VA	05/14/2021		
Integrality (Integrality, LLC)	Dallas, TX	05/14/2021		
Integrity Operations	Katy, TX	05/14/2021		
Intellyk Inc	Piscataway, NJ	05/14/2021		
Interprise Software (Intrinity Incorporated)	Waterloo, ON	05/14/2021		
Interprise/Southwest Interior & Space Planning, In	Addison, TX	05/14/2021		
Invo Healthcare Associates (Invo Healthcare Associates, LLC)	Jamison, PA	05/14/2021		
IOS Acquisitions LLC	New York, NY	05/14/2021		
IPM Asset Solutions, Inc.	Houston, TX	05/14/2021		
IP Terra International Corporation	Houston, TX	05/14/2021		
I-Raos, Inc	Pearland, TX	05/14/2021		
Irving Hernandez	Austin, TX	05/14/2021		
ISE International Group	Bethesda, MD	05/14/2021		
ISES Corporation	Duluth, GA	05/14/2021		
Its Your Time To Flourish	Houston, TX	05/14/2021		
itsQuest, Inc.	Lubbock, TX	05/14/2021		
iWRITE (I Write)	Houston, TX	05/14/2021		
J Dorthen Martin, Speaker, Life Coach, Image Consultant	Houston, TX	05/14/2021		
Jackson Walker L.L.P.	Dallas, TX	05/14/2021		
JAGGAER	Morrisville, NC	05/14/2021		
Jaime Rios Financial Services Inc. (Money Concepts International Inc.)	Corpus Christi, TX	05/14/2021		
Janet Pozmantier, M.S., LPC, LMFT, RPT (Janet Pozmantier)	Houston, TX	05/14/2021		
JAVACCS, LLC	Humble, TX	05/14/2021		
JAVACCS, LLC and Johnson Second Chance - Vivian's Digital Learning Academy, LL	Houston, TX, TX	05/14/2021		
Javier Lopez	Houston, TX	05/14/2021		
JC Stonewall Constructors, LP	Houston, TX	05/14/2021		
Jean Polichino Consulting, LLC	Fredericksburg, TX	05/14/2021		
Jennifer Serravallo Consulting, LLC	South Orange, NJ	05/14/2021		
JER HR Group LLC	New York, NY	05/14/2021		
Jerry Gaither Enterprise	HOUSTON, TX	05/14/2021		
Jigsaw Learning LLC (TeachTown)	Woburn, MA	05/14/2021		
JLA Construction Solutions	Houston, TX	05/14/2021		
JLL (Jones Lang LaSalle, Americas, Inc.)	Houston, TX	05/14/2021		
JLL Valuation & Advisory Services, LLC	Houston, TX	05/14/2021		
Johnson Consulting (Adrian B. Johnson)	Houston, TX	05/14/2021		
Johnston, LLC	Houston, TX	05/14/2021		
Jon M. Warren, LLC	Decatur, TX	05/14/2021		
Jones Lang LaSalle (JLL)	Houston, TX	05/14/2021		
Jose Villarreal Consulting Services	Houston, TX	05/14/2021	Viewed	05/14/2021
Journeys Managing Group LLC	Houston, TX	05/14/2021		
Joyce Davis/Erin Whitney	Houston, TX	05/14/2021		
JPMorgan	Houston, TX	05/14/2021		
JPMorgan Chase	Fort Worth, TX	05/14/2021		
JQ Infrastructure, LLC	Dallas, TX	05/14/2021		
JS&D Sports Development Outreach Ministries	Humble, TX	05/14/2021		
Jv-janitorial	Fortworth, TX	05/14/2021		
K Gab Assessments, Inc	Missouri City, TX	05/14/2021		
K&R Group, INC	Houston, TX	05/14/2021		

K12 Food Pros	La Mesa, CA	05/14/2021		
K12 Insight	Herndon, VA	05/14/2021		
K2 Consulting (K2 Construction Consultants, Inc.)	Bethesda, MD	05/14/2021		
KAEKA GROUP INC	Lacey, WA	05/14/2021		
Kagan Publishing & Professional Development	San Clemente, CA	05/14/2021		
KANKO (Floyd's Chores & Odd Jobs)	Dallas, TX	05/14/2021		
Karczewski Bradshaw, LLP	Nacogdoches, TX	05/14/2021		
KATTA INFOTEK INC	HOUSTON, TX	05/14/2021		
KCP Educational Consulting (Kristi Clarkson Pharaon)	Brenham, TX	05/14/2021		
Key Group LLC	Rosharon, TX	05/14/2021		
Kennesaw State University iTeach (Elkins Pointe MS)	Kennesaw, GA	05/14/2021		
Keter Environmental Services	Indianapolis, IN	05/14/2021		
Keys to Literacy	Rowley, MA	05/14/2021		
KGBTexas Communications	Houston, TX	05/14/2021		
KH Literacy Education LLC (Kristen Leanne Henry)	San Antonio, TX	05/14/2021		
Kijo Consulting LLC	Houston, TX	05/14/2021		
Kiln Services of North Texas	Highland Village, TX	05/14/2021		
Kinetic Potential Scholars (Digital Network Group)	Largo, MD	05/14/2021		
Kingham Dalton Wilson, Ltd.	Houston, TX	05/14/2021		
KLD PLAYSCAPES USA (TWO WORD COMPANY LLC)	Boca Raton, FL	05/14/2021		
KMD Hospitality (KMD Hospitality LLC)	Humble, TX	05/14/2021		
Konnecting the Dots	Houston, TX	05/14/2021		
Kontrol Payables	Spokane, WA	05/14/2021		
Kriston Construction Company Inc	Beaumont, TX	05/14/2021		
KTM Educational Consulting, LLC	San Antonio, TX	05/14/2021		
L&S Associates, LLC	Montgomery, TX	05/14/2021		
L.SMURPHE.F Institute; Solutions by L.SMURPHE.F; L.SMURPHE.F Productions (L.SMURPHE.F Enterprises, Ltd. Co.)	League City, TX	05/14/2021		
La Capra Associates, Inc.	Boston, MA	05/14/2021		
Lady Liberty Group LLC	Eules, TX	05/14/2021		
Lan Nguyen	Houston, TX	05/14/2021		
Language Dynamics Group	Laramie, WY	05/14/2021		
Language Kids Houston, LLC	Sugar Land, TX	05/14/2021		
Lantana Communications	Arlington, TX	05/14/2021		
LaPorte CPAs and Busienss Advisors (LaPorte CPAs APAC)	Houston, TX	05/14/2021		
LATT Evaluations and Services, PLLC (La Shaun Arzu, PLLC)	Houston, TX	05/14/2021		
Launch Point CDC, Inc.	Houston, TX	05/14/2021		
LaVondia Menephee	Houston, TX	05/14/2021		
LBNM Corporation	Richmond, TX	05/14/2021		
Leading School Learning	Cypress, TX	05/14/2021		
Learning Omnivores (William Sommers)	Austin, TX	05/14/2021		
Lee Rutledge Consulting (Rutledge)	Austin, TX	05/14/2021		
Legends Do Live	Missouri City, TX	05/14/2021		
Leidos, Inc.	Maitland, FL	05/14/2021		
Levy's Tutorial and Enrichment Center (Mary Baumann)	Houston, TX		No Bid	05/28/2021 05/28/2021
Libra-Tech Corporation	Argyle, TX	05/14/2021		
Licensed To Solve (Dukes Global Works, INC)	CROSBY, TX	05/14/2021		
Lighthouse Groups LLC	Saint Louis, MO	05/14/2021		
Linder Consulting LLC	AUSTIN, TX	05/14/2021		
Liquid Studio Group	Laredo, TX	05/14/2021		
Lisa K Bailey	Missouri City, TX	05/14/2021		
Live Green Teams (CALPAA, Inc)	Seattle, WA	05/14/2021		
Logyx	Mountain View, CA	05/14/2021		
Lone Star Security Shield, Inc.	Houston, TX	05/14/2021		
Look to Success, LLC (Michelle Lee Pina)	Houston, TX	05/14/2021		
Love 2 the Max	Houston, TX	05/14/2021		
Lovescaping LLC	Houston, TX	05/14/2021		
Loves Companies Inc	Mooreville, NC	05/14/2021		
LQI Consulting Group, LLC	Round Rock, TX	05/14/2021		

L-Sync, LLC	Grand Prairie, TX	05/14/2021			
Lucy Anderson	Houston, TX	05/14/2021			
lurie, llp	Minneapolis, MN	05/14/2021			
Lynn Gomes, LLC (Lynn Gomes)	Houston, TX	05/14/2021			
M&H Lighting Systems (Mapenzi Group)	Pearland, TX	05/14/2021			
M.E.N. (Mentoring, Educating & Nurturing) Incorporated (MEN Inc.)	Houston, TX	05/14/2021	No Bid	05/14/2021	05/14/2021
M3 Inc	Brooklyn, NY	05/14/2021			
Main Stop Testing Svcs	Houston, TX	05/14/2021			
Majestic Transportation	Pearland, TX	05/14/2021			
Maker Maven	Tomball, TX	05/14/2021			
Makr U	Spring, TX	05/14/2021			
Malor & Company Inc	New York, NY	05/14/2021			
Marathon Partners Consulting	Moon Township, PA	05/14/2021			
Marathon Staffing Group, Inc.	Tyngsboro, MA	05/14/2021			
Mark Collins Construction LLC	League City, TX	05/14/2021			
Mark J. Rogers	Austin, TX	05/14/2021			
Mark Matranga	Fort Worth, TX	05/14/2021			
Marketing Addiction Inc.	Houston, TX	05/14/2021			
Marseal Group	Roanoke, TX	05/14/2021			
Mary Benton Communications and Public Affairs	Houston, TX	05/14/2021			
MAS Solutions LLC.	Fulshear, TX	05/14/2021			
Masterson Advisors LLC	Houston, TX	05/14/2021	Submitted	06/01/2021	06/01/2021
Math-A-Matics Tutoring,LLC	Houston, TX	05/14/2021			
Maxim Healthcare Staffing Services, Inc.	San Luis Obispo, CA	05/14/2021			
MAXIMUS	Reston, VA	05/14/2021			
MCA Communications	Houston, TX	05/14/2021			
McConnell & Jones LLP	Houston, TX	05/14/2021			
McKinstry (McKinstry Essention, Inc.)	Dallas, TX	05/14/2021			
MCP Professional Services (Dr. Deloris L. Nelson)	Houston, TX	05/14/2021			
MedHelp, Inc.	Baltimore, MD	05/14/2021			
Mediators of Texas (Austin Texas Mediators LLC)	Florence, TX	05/14/2021			
Medicaid Claim Solutions of Texas, Inc.	Mansfield, TX	05/14/2021			
Melba Figueroa (HonestRx Consulting LLC)	Southlake, TX	05/14/2021			
Melton & Melton, LLP	Houston, TX	05/14/2021			
MERCER TECHNOLOGIES FIRM	Gary, IN	05/14/2021			
Metamorphosis Concepts	Manvel, TX	05/14/2021			
Meveau (Mercedes Watkins)	Houston, TX	05/14/2021			
Michael Best Strategies	Madison, WI	05/14/2021			
Microburst Learning, LLC	Columbia, SC	05/14/2021			
Mills Systems Solutions, LLC	Farmers Branch, TX	05/14/2021			
Millunzi & Associates	The Woodlands, TX	05/14/2021			
Minding YOB Services, LLC	Arlington, TX	05/14/2021			
Mitaja Corporation	Fulton, MD	05/14/2021			
Mixxdd Marketing	Kenedy, TX	05/14/2021			
MJR EDUCATIONAL SUPPLIES	Houston, TX	05/14/2021	Viewed	05/21/2021	
ML Deer Construction	Houston, TX	05/14/2021			
MMG Consulting Partners (Maryland Grier-Union)	Houston, TX	05/14/2021			
MNB Services	Houston, TX	05/14/2021			
Mobile Collegiate	Dallas, TX	05/14/2021			
Modified Logic	Prosper, TX	05/14/2021			
Monica Lewis School of Etiquette	Spring, TX	05/14/2021			
Moody National Bank	Galveston, TX	05/14/2021			
Moore Counseling and Psychological Services (Lorenzo Moore)	Houston, TX	05/14/2021			
Mosley School of Oratory	Houston, TX	05/14/2021			
MPACT STRATEGIC CONSULTING, LLC	Houston, TX	05/14/2021			
MSB Consulting LLC	Austin, TX	05/14/2021			
MSys inc	washington, DC	05/14/2021			
MVHL Consulting, LLC	San Antonio, TX	05/14/2021			
Namitzi Yoga (Mitzi Henderson)	HOUSTON, TX	05/14/2021			
Nasare Enterprises,LLC.	Houston, TX	05/14/2021			
National Energy Solutions	Houston, TX	05/14/2021			
NationSync (NationSync Corporation)	Houston, TX	05/14/2021			
Nazca Technologies and Consulting LLC	MONTGOMERY, TX	05/14/2021			
NEDRP, LLC (RD360 EDUCATIONAL CONSULTING)	Canyon Lake, TX	05/14/2021			

NERDY BIRDIE (ENOVATEKK)	SPRING, TX	05/14/2021			
New Spectrum Educational Consultants (Civil Society Educational Consultants)	Houston, TX	05/14/2021			
New Teacher Center	Santa Cruz, CA	05/14/2021			
Newspring	Houston, TX	05/14/2021			
Nichelle Pinkney, The Urban Scholar, Independent Consultant (Nichelle Pinkney)	Houston, TX	05/14/2021			
no bully here	PASADENA, TX	05/14/2021			
NO EGO APPAREL (NO EGO INC)	AUSTIN, TX	05/14/2021			
NuHealth, Inc.	Houston, TX	05/14/2021			
NURSES Etc STAFFING (Donald L Mooney Enterprises, LLC)	San Antonio, TX	05/14/2021			
Nurture to Blossom Services, Inc.	Houston, TX	05/14/2021			
Nuvalo LLC	Gig Harbor, WA	05/14/2021			
Nylinka School Solutions	Kensington, MD	05/14/2021			
Oak Hill Technology, Inc.	Driftwood, TX	05/14/2021			
Odigo Services LLC	Houston, TX	05/14/2021			
O'Hanlon, Demerath & Castillo	Austin, TX	05/14/2021			
Olivier, Inc.	Dallas, TX	05/14/2021			
Omega Engineers, Inc.	Houston, TX	05/14/2021			
Ondi Love Center Ministries	Houston, TX	05/14/2021			
One Source International, LLC	Houston, TX	05/14/2021			
One Way Education, LLC	Houston, TX	05/14/2021			
Operations Contracting Agency LLC	Schertz, TX	05/14/2021			
Optima Train (Delwar Enterprises LLC)	Houston, TX	05/14/2021			
Optimum Lifestyle CDC (www.olcdconline.org)	Houston, TX	05/14/2021			
Orrick, Herrington & Sutcliffe LLP	Houston, TX	05/14/2021			
Own the Room Communication Coaching & Consulting (Rukiya M. Akua)	Houston, TX	05/14/2021			
Ozeal Consulting Group (Oziel Enriquez)	Sugar Land, TX	05/14/2021			
P Eugene Turner	Waller, TX	05/14/2021			
Padgett, Stratemann & Co., L.L.P.	San Antonio, TX	05/14/2021			
Pangea Biological (Okapi Environmental Group, Inc.)	Carlsbad, CA	05/14/2021			
Panorama Education	Boston, MA	05/14/2021			
Parker and Jamison LLC	Irving, TX	05/14/2021			
Patricia Monticello Kievlan (Patricia Marie Kievlan)	The Woodlands, TX	05/14/2021			
PAUL J. COSELLI, ATTORNEY AT LAW	BELLAIRE, TX	05/14/2021			
Payton, Nix & Associates, LLC	LUCAS, TX	05/14/2021			
Pcubed (Program Planning Professionals)	Ann Arbor, MI	05/14/2021			
Penelton Consulting Services, LLC	Houston, TX	05/14/2021	Viewed	05/25/2021	
Personal Touch Therapy (Shontai Thomas)	Houston, TX	05/14/2021			
Personnel Evaluation, Inc.	Milwaukee, WI	05/14/2021			
PESG of Texas	Houston, TX	05/14/2021			
PEX (Prepaid Expense Card Solutions, Inc)	New York, NY	05/14/2021			
PFM Financial Advisors LLC	Houston, TX		No Bid	06/01/2021	06/01/2021
PHD Resources & Taxes	Houston, TX	05/14/2021			
Phillip (Barker)	Houston, TX	05/14/2021			
Pinnacle Workforce Strategies	Tucson, AZ	05/14/2021			
Piper Sandler & Co.	Houston, TX	05/14/2021			
Pittman Training (Vision Educational Solutions)	Dallas, TX	05/14/2021			
PlainsCapital Bank	Pharr, TX	05/14/2021			
Plante & Moran, PLLC	Southfield, MI	05/14/2021			
Plexos Group LLC	Baton Rouge, LA	05/14/2021			
Point Alliance Solutions	Spring, TX	05/14/2021			
Porter Brown Associates	Alachua, FL	05/14/2021			
Positive Behavior Supports Corp	IRVING, TX	05/14/2021			
Postlethwaite & Netterville APAC (Lacher)	Baton Rouge, LA	05/14/2021			
Powell-Leon, LLP	Austin, TX	05/14/2021			
Power Institute LLC	Missouri City, TX	05/14/2021			
Power of Choosing Inc.	Texas, TX	05/14/2021			
Practical Parent Education	Mckinney, TX	05/14/2021			
Precision Medical Billing (PMB Precision Medical Billing, Inc.)	Houston, TX	05/14/2021			
Premier Employee Solutions	Provo, UT	05/14/2021			
Premier Staffing Source, Inc.	Lanham, MD	05/14/2021			

Premiere Speakers Bureau	Franklin, TN	05/14/2021			
Presidential Staffing Solutions	San Antonio, TX	05/14/2021			
Price Consulting, Inc.	Houston, TX	05/14/2021			
Prime Sanitizing	Mckinney, TX	05/14/2021			
Proactive Thought Leaders, LLC	Arlington, TX	05/14/2021			
ProBizAssoc.com (Beth Philley)	Canton, OH	05/14/2021			
Probolsky Research	Newport Beach, CA	05/14/2021			
PROCEDEO	Fort Worth, TX	05/14/2021			
Prodigi, LLC	Lewes, DE	05/14/2021			
Productive Ventures	Spring, TX	05/14/2021			
Professional Credit Service (Ray Klein Inc)	Vancouver, WA	05/14/2021			
Projects-Matter (Projects-Matter LLC)	Houston, TX	05/14/2021			
Promos On-Time	New York, NY	05/14/2021			
Pronto Shipping and Packaging Services Inc.	Houston, TX	05/14/2021			
Prosperity Project Management LLC (N/A)	Washington, DC	05/14/2021			
PROTECHT Management Group, LLC	Austin, TX	05/14/2021			
Protection Engineering Consultants LLC	Austin, TX	05/14/2021			
Protiviti	Houston, TX	05/14/2021			
PSST, LLC (PSST Acquisition, LLC)	Louisville, KY	05/14/2021			
PST Services, Inc., a McKesson company (PST Services, Inc.)	Alpharetta, GA	05/14/2021			
Public Works LLC	West Chester, PA	05/14/2021			
PuckettPro (PuckettPro Inc)	TX, TX	05/14/2021			
Purposeful Parents	Webster, TX	05/14/2021			
PVH Consulting Group LLC	Austin, TX	05/14/2021			
PVMA, LLC (Project & Vendor Management Advisors, LLC)	Houston, TX	05/14/2021			
Quintero Enterprises (Zoom Technologies LLC)	Ridgewood, NY	05/14/2021			
Rachel Brownlie	Houston, TX	05/14/2021			
Ramos & Harrison	Corpus Christi, TX	05/14/2021			
Randles & Associates, LLC	Corpus Christi, TX	05/14/2021			
RBC Capital Markets, LLC	Dallas, TX		No Bid	05/18/2021	06/01/2021
RDI Global Services	El Paso, TX	05/14/2021			
RDI Mechanical	Houston, TX	05/14/2021			
Real Good Technologies	Austin, TX	05/14/2021			
Recruiting In Motion	Orlando, FL	05/14/2021			
Recruiting Source International	Katy, TX	05/14/2021			
Reflective Energy Solutions	Hackensack, NJ	05/14/2021			
Region One Education Service Center	Edinburg, TX	05/14/2021			
Reliable R&R Training Services	Dallas, TX	05/14/2021			
Reliant Elevators (Reliant Elevators, LLC)	Joshua, TX	05/14/2021			
Relocation Strategies (Luo & Chang Investment LLC)	houston, TX	05/14/2021			
Remember When Kids Were Kids (Jaelijah)	Spring, TX	05/14/2021			
Remy Dillenseger	Houston, TX	05/14/2021			
Resolute Educational Solutions, L.L.C.	Detroit, MI	05/14/2021			
Responsive Learning (Responsive Learning, LP)	El Paso, TX	05/14/2021			
RG Guillory Education & Consulting, LLC	Houston, TX	05/14/2021			
Rice & Associates, PC	Houston, TX	05/14/2021			
Richards/Carlberg (Richards Carlberg, Inc.)	Houston, TX	05/14/2021			
Ricoh USA	Houston, TX	05/14/2021			
Rising Star Academy	Houston, TX	05/14/2021			
Rivera-Vega Group, LLC.	San Antonio, TX	05/14/2021			
RND Technology	Houston, TX	05/14/2021			
Roberts Enterprise	Houston, TX	05/14/2021			
Rogers, Morris & Grover, LLP	Houston, TX	05/14/2021			
Roland Gonzales	Spring, TX	05/14/2021			
RR CONNECTION CONSULTING	Duncanville, TX	05/14/2021			
Rukaz Kultura	HOUSTON, TX	05/14/2021			
S Corporation	Phila, PA	05/14/2021			
s3strategies	Lubbock, TX	05/14/2021			
Sabari Tech Solutions LLC	Richmond, TX	05/14/2021			
SAMCO Capital Markets, Inc.	San Antonio, TX	05/14/2021			
Sanders Services (Richard Sanders)	Morrow, GA	05/14/2021			
Santos Alliances	Austin, TX	05/14/2021			
SBC Consulting (Tammy Smithers)	Houston, TX	05/14/2021			
SBL Solutions (Strategic Business Life Solutions)	Rosharon, TX	05/14/2021			



SBLM Architects	New York, NY	05/14/2021
SCG Business Services, LLC	Douglasville, GA	05/14/2021
School Food Service Innovations	Jourdanton, TX	05/14/2021
Schulman, Lopez, Hoffer & Adelstein	Houston, TX	05/14/2021
Schultz Center for Teaching and Leadership, Inc.	Jacksonville, FL	05/14/2021
Science Unlimited, LLC	Missouri City, TX	05/14/2021
Second Chance Learning Center	Houston, TX	05/14/2021
Second Chance Technology Edge High School	Houston, TX	05/14/2021
ServiceMaster Recovery Management (Service Environments of Texas, Inc.)	Kingwood, TX	05/14/2021
Session Tax Consulting & Grant Writing (Session Tax Consulting and grant writing)	HOUSTON, TX	05/14/2021
Shaneka Smith	Houston, TX	05/14/2021
Sharron Helmke	Dickinson, TX	05/14/2021
Shepherd Government Services Group (SGSG, LLC)	Carrollton, TX	05/14/2021
Shine Bright Tutoring (LPOH, LLC)	Pearland, TX	05/14/2021
Sierra Consulting, Inc	Itasca, IL	05/14/2021
Sigga Workforce Technologies	Sugar Land, TX	05/14/2021
Sigma Consulting Corp.	Metairie, LA	05/14/2021
Sign Advisors (Cost Advisors of Texas, LLC)	Houston, TX	05/14/2021
SilkWeb Consulting and Development, LLC	Scottsdale, AZ	05/14/2021
SimiDigi Inc	Garland, TX	05/14/2021
Sketch City	Houston, TX	05/14/2021
Sky Creations (Rachael Bassey)	Midland, TX	05/14/2021
Sky's the Limit	Houston, TX	05/14/2021
SL King and Associates	Atlanta, GA	05/14/2021
Slalom (Slalom LLC)	Houston, TX	05/14/2021
SLL Services, LLC	Palestine, TX	05/14/2021
Smart Scholars Foundation	Houston, TX	05/14/2021
Smarter HR Solutions	Houston, TX	05/14/2021
SMARTOX	Irving, TX	05/14/2021
SMRT Solutions (SMRT Consulting LLC)	Washington DC, DC	05/14/2021
SnapTemps Staffing, ProFinal Clean, ExactScreen, SafeSource (Affinity Professional Group, LLC.)	Houston, TX	05/14/2021
SOA Fin1st	Pearland, TX	05/14/2021
Social Motion, Inc.	Houston, TX	05/14/2021
Social Studies Success	Spring, TX	05/14/2021
Softline International USA, Inc	Miami, FL	05/14/2021
Solel International	Houston, TX	05/14/2021
Solix Inc. dba Sivic Solutions (Sivic Solutions Group LLC)	Parsippany, NJ	05/14/2021
south texas boiler	houston, TX	05/14/2021
South Texas Counseling and Mentoring : Adult Education	Houston, TX	05/14/2021
Southeast Technical Solutions	League City, TX	05/14/2021
Southwest Glen Mission	Houston, TX	05/14/2021
SPDF KIDS	Houston, TX	05/14/2021
Special Evaluations & Consulting of Texas	Dallas, TX	05/14/2021
Springsted Human Capital Advisors	St. Paul, MN	05/14/2021
Spur Employment, Inc.	HUNTSVILLE, AL	05/14/2021
SPZ GLOBAL ENERGY LLC	north bergen, NJ	05/14/2021
SSCI Environmental (Separation Systems Consultants, Inc.)	Houston, TX	05/14/2021
SSG-MUSIC	LAS VEGAS, NV	05/14/2021
Staff Hunt LLC	Houston, TX	05/14/2021
STAFF TODAY INC (STI)	COVINA, CA	05/14/2021
Staffmark (Staffmark Investment LLC)	Cincinnati, OH	05/14/2021
Standard Morgan Partners, LTD	Houston, TX	05/14/2021
Standing In The Gap Direct Hire Consulting	San Antonio, TX	05/14/2021
Steam Kidstitute (Insight Community Resources Inc)	Houston, TX	05/14/2021
STEM Urban Perspective (Science, Technology, Engineering with an Urban Perspective)	Humble, TX	05/14/2021
Sterling Empowerment	HOUSTON, TX	05/14/2021
Sterling Staffing Solutions (Maceo Carter Investments, LLC)	Sugar Land, TX	05/14/2021

Sterling Therapy & Rehabilitation	SUGAR LAND, TX	05/14/2021			
Stetson & Associates, Inc.	Houston, TX	05/14/2021			
Steve Spangler Inc.	Littleton, CO	05/14/2021			
Stevenson Workshop and Seminar Solutions	league city, TX	05/14/2021			
Stifel, Nicolaus & Company, Inc.	Houston, TX	05/14/2021	Submitted	05/28/2021	05/28/2021
Stone Oak Solutions, LLC	New Braunfels, TX	05/14/2021			
Storytelli' Time (MARY JO HUFF)	NEWBURGH, IN	05/14/2021			
Strahan Cain, PLLC	Houston, TX	05/14/2021			
Straight Defined	Copperas Cove, TX	05/14/2021			
Straight Line Management (Straight Line Management LLC)	San Antonio, TX	05/14/2021			
Strategar (Strategar LLC)	Addison, TX	05/14/2021			
Strategic Partnerships, Inc.	Austin, TX	05/14/2021			
Strategic Solutions Group	Needham, MA	05/14/2021			
STRAUS SYSTEMS INC	STAFFORD, TX	05/14/2021			
Streamline Health Services	San Juan Capistrano, CA	05/14/2021			
Students of Strength, Inc.	Cambridge, MA	05/14/2021			
Successful Starters Learning Academy II	Houston, TX	05/14/2021			
Supporting Educators Daily	Missouri City, TX	05/14/2021			
Susan M. Catlett, Ph.D., BCBA-D	Houston, TX	05/14/2021			
SWA International Company	Houston, TX	05/14/2021			
T.E.B Benefits Group Inc	El Paso, TX	05/14/2021			
Table SALT Group	Houston, TX	05/14/2021			
TalentStaff	Spring, TX	05/14/2021			
Tammy Rodney	Houston, TX	05/14/2021			
Tandi Oil and Gas LLC	KATY, TX	05/14/2021			
TCT Enterprises, LLC	Houston, TX	05/14/2021			
Teach2Learn (Elliott and McMahan)	Friendswood, TX	05/14/2021			
Teaching Strategies, LLC	Bethesda, MD	05/14/2021			
Team Driven Technology Inc.	Fort Worth, TX	05/14/2021			
TeamLogic IT (Philoxenus, Inc.)	Houston, TX	05/14/2021			
TEC Sales	college station, TX	05/14/2021			
Tecnics Consulting, Inc.	Houston, TX	05/14/2021			
TEEN TRUTH (TEEN TRUTH, LLC)	DRIPPING SPRINGS, TX	05/14/2021			
Tekgration LLC	San Antonio, TX	05/14/2021			
Tetra Tech, Inc.	Maitland, FL	05/14/2021			
Texan-French Alliance for the Arts	Houston, TX	05/14/2021			
Texans Together Education Fund Inc	Houston, TX	05/14/2021			
Texas Association of African American Chambers of Commerce (TAAACC)	Austin, TX	05/14/2021			
Texas Educational Consultative Services, Inc.	Austin, TX	05/14/2021			
Texas Gulf Bank N.A.	Houston, TX	05/14/2021			
Texas Initiative Programs (The K16 Ready Society, Inc.)	Fort Worth, TX	05/14/2021			
Texas STAAR Publishing, LLC	Sugarland, TX	05/14/2021			
Texas State Billing Services Inc	Kyle, TX	05/14/2021			
TexConnect Communications, LLC	Brazoria, TX	05/14/2021			
The Afterschool Professional	Pflugerville, TX	05/14/2021			
The A-List Network, LLC (Stephanie Belton)	Rosharon, TX	05/14/2021			
The Bob Pike Group	Bloomington, MN	05/14/2021			
The Box Program (Box Program)	Baytown, TX	05/14/2021			
The Business Concierge (Goodwill Houston)	Houston, TX	05/14/2021			
The Carmona Firm, PLLC	Houston, TX	05/14/2021			
The Christopher Quinn Group Inc.	Dallas, TX	05/14/2021			
The Class Ring Company	McAllen, TX	05/14/2021			
The CNA Corporation (CNA)	Arlington, VA	05/14/2021			
The Danielson Group	Chicago, IL	05/14/2021			
The Donatto Group	Houston, TX	05/14/2021			
The E2 Group, Inc.	Sugar Land, TX	05/14/2021			
The Educator Collaborative	Astoria, NY	05/14/2021			
The Fulton Law Group PLLC	Houston, TX	05/14/2021			
The Green Alliance	Katy, TX	05/14/2021			
The Hanover Research Council, LLC	Arlington, VA	05/14/2021			
The Harris Foundation	Houston, TX	05/14/2021			
The Healthy School Food Collaborative	New Orleans, LA	05/14/2021			
The Heart of God Restoration Ministry	Houston, TX	05/14/2021			
The K.N.E.W. Solutions (Keschia Matthews)	FRESNO, TX	05/14/2021			

The Kadence Collective, LLC	San Antonio, TX	05/14/2021			
The KD Company (Kim Y. Davis Enterprises, LLC)	Houston, TX	05/14/2021			
The King & Associates Firm	Brazoria, TX	05/14/2021			
The Knowledge Stack (The Knowledge Stack LLC)	Los Angeles, CA	05/14/2021			
The Kovacs Group	New Braunfels, TX	05/14/2021			
The MINT National Bank	Kingwood, TX	05/14/2021			
The National Behavioral Intervention Team Association	King of Prussia, PA	05/14/2021			
The Ombudsmen Group	Cibolo, TX	05/14/2021			
The Outreach Program Education/Counseling Services	Houston, TX	05/14/2021			
The Paper Plate, Inc	Dallas, TX	05/14/2021			
The Parent Coach	HOUSTON, TX	05/14/2021			
The Platform	Houston, TX	05/14/2021			
The Process Manager (Meliton Moya, Ph.D.)	Edinburg, TX	05/14/2021			
The Resilient Group	Houston, TX	05/14/2021			
The Schlueter Group (Stan Schlueter)	Austin, TX	05/14/2021			
The Style Signature	Carrollton, TX	05/14/2021			
The TEAMS Group, LLC	Austin, TX	05/14/2021			
The Trade Group	Carrollton, TX	05/14/2021			
The Yates Company	Houston, TX	05/14/2021			
TheDataFyles	Bellaire, TX	05/14/2021			
Therapy Consultants (MedPerm Placement Inc)	Houston, TX	05/14/2021			
Theresa Harris	HOUSTON, TX	05/14/2021			
thinkLaw (CS Educational Services, LLC)	Las Vegas, NV	05/14/2021			
Thomas Educational Solutions	Pearland, TX	05/14/2021			
Thompson & Horton LLP	Houston, TX	05/14/2021			
Thompson Educational Consulting, Inc.	Missouri City, TX	05/14/2021			
Tier One Learning, LLC	Sugar Land, TX	05/14/2021			
Tijerina Galvan Lawrence LLC	Houston, TX		Submitted	05/26/2021	05/26/2021
Timothy Project: Youth Mentoring Youth, Inc.	Houston, TX	05/14/2021			
TinMan Enterprises (TX TinMan Enterprises, LLC)	Fort Worth, TX	05/14/2021			
Tiphany Chambers Burrell	HOUSTON, TX	05/14/2021			
TISOMO Consulting Group, LLC	Jacksonville, FL	05/14/2021			
TITAN School Solutions, Inc.	Irvine, CA	05/14/2021			
TLE Inc (The Look Enterprises, Inc.)	Bellaire, TX	05/14/2021			
TMB Screen Printing & Embroidery Spring	Spring, TX	05/14/2021			
TMI Solutions, LLC	George West, TX	05/14/2021			
TNCPA	Houston, TX	05/14/2021			
TNR Accounting & Management Consulting, LLC (Nannette Ray)	Katy, TX	05/14/2021			
TNTP (The New Teacher Project, Inc.)	Brooklyn, NY	05/14/2021			
Tomorrow N Training	Houston, TX	05/14/2021			
Total Administrative Services Corporation	Madsion, WI	05/14/2021			
Total Special Education Solutions, LLC	Beaumont, TX	05/14/2021			
TPR Education LLC (The Princeton Review)	Natick, MA	05/14/2021			
Trace3, Inc.	Irvine, CA	05/14/2021			
Transaption	Wilmington, DE	05/14/2021			
Transcare llc	Houston, TX	05/14/2021			
Transformation7 by Tiffany A. Washington	Houston, TX	05/14/2021			
Translation & Interpretation Network (Catholic Charities Diocese of Fort Worth, Inc. d/b/a Translation & Interpretation Network)	Fort Worth, TX	05/14/2021			
TransLinguist Translation & Document Clearing LLC	Dubai,	05/14/2021			
Trezvant Academy, Inc	Houston, TX	05/14/2021			
Trinity Review Services Inc	Houston, TX	05/14/2021			
True Love Childcare	Humble, TX	05/14/2021			
Trustmark National Bank	Jackson, MS	05/14/2021			
TSC COGIC	houston, TX	05/14/2021			
TSG Industries (The Sithe Group, LLC.)	Houston, TX	05/14/2021			
Tutor Doctor	Navasota, TX	05/14/2021			
Tynker	Mountain View, CA	05/14/2021			
U. S. WHOLESALE PRODUCTS	SAN ANTONIO, TX	05/14/2021			
U.S. Dream Academy, Inc	Columbia, PA	05/14/2021			

U-Bridge Project Consulting, LLC	Sugarland, TX	05/14/2021		
UNICOM Government, Inc. F/K/A GTSI Corp.	Chantilly, VA	05/14/2021	Viewed	05/14/2021
Unified Sunergy Systems LLC	Flower Mound, TX	05/14/2021		
Unity National Bank of Houston	Houston, TX	05/14/2021		
Unlimited Visions Aftercare, Inc	Houston, TX	05/14/2021		
UNTAPPED Genius	Missouri City, TX	05/14/2021		
UP Educational Consulting	Conroe, TX	05/14/2021		
US CAPITAL ADVISORS LLC	HOUSTON, TX		Submitted	06/01/2021 06/01/2021
US Executive LLC	Tampa, FL	05/14/2021		
USG Staffing LLC	Humble, TX	05/14/2021		
Uturn Concepts Inc	Houston, TX	05/14/2021		
Vanguard Trading & Services, LLC	Houston, TX	05/14/2021		
VantagePoint Benefits (J. Peat & Associates)	Lynbrook, NY	05/14/2021		
Velvet Rope Experience (VRE Business Solutions)	Houston, TX	05/14/2021		
Victory Group	Houston, TX	05/14/2021		
Vinnove Consulting Group	San Antonio, TX	05/14/2021		
Virtuo Group Corporation	The Woodlands, TX	05/14/2021		
Visual Communication Services (Webbco Enterprises, LLC)	Houston, TX	05/14/2021		
Volition IIT Inc	ASHBURN, VA	05/14/2021		
VOX Global	Dallas, TX	05/14/2021		
VRJ & Associates, LLC	Sugar Land, TX	05/14/2021		
vTech Solution Inc.	Washington, DC	05/14/2021		
W.J. Alexander & Associates, P.C.	Houston, TX	05/14/2021		
Waits Consulting Group	Houston, TX	05/14/2021		
Walk the Walk Promotions	Richardson, TX	05/14/2021		
Walker Quality Services	Cypress, TX	05/14/2021		
Walsh Gallegos Treviño Russo & Kyle P.C.	Austin, TX	05/14/2021		
WaterLily Writing, LLC	Arlington, TX	05/14/2021		
Watkins & Associates Consulting Services LLC.	Houston, TX	05/14/2021		
Weaver	Houston, TX	05/14/2021		
Weaver and Tidwell, LLP	Houston, TX	05/14/2021		
Weber Services	Montgomery, TX	05/14/2021	Viewed	05/15/2021
Wellesley College	Wellesley, MA	05/14/2021		
Wells Fargo Bank NA	Minneapolis, MN	05/14/2021		
Wells Fargo Bank. NA	Houston, TX	05/14/2021		
Wellspring Family & Community Institute	Houston, TX	05/14/2021		
Wendy Perry Coparenting Education (www.wendyjerry.com)	Watauga, TX	05/14/2021		
Westat	San Antonio, TX	05/14/2021		
Whitley Penn	Houston, TX	05/14/2021		
Whitley Penn, LLP	Houston, TX	05/14/2021		
Willdan Engineering	Anaheim, CA	05/14/2021		
Williams Education Consulting	Houston, TX	05/14/2021		
Williams Technical Staffing	Sugar Land, TX	05/14/2021		
Workshop Houston	Houston, TX	05/14/2021		
Wright One Training	Flower Mound, TX	05/14/2021		
Writers in the Schools	Houston, TX	05/14/2021		
Writing with Design (The Learning Project)	Norman, OK	05/14/2021		
WRM Development	Selma, TX	05/14/2021		
Wylie Construction Services	Humble, TX	05/14/2021		
xtremetees embroidery and printing	San Juan, TX	05/14/2021		
Yolah - Yolandra Drake	Houston, TX	05/14/2021		
Young Women Christian Association of Houston	Houston, TX	05/14/2021		
Your Business Solutions (Distinguished Network Engenuity, Inc.)	The Woodlands, TX	05/14/2021		
Your Pro Medical Inc. (Your Pro Consultant Inc.)	Bedford, TX	05/14/2021		
Youth Advocacy TEAM	Houston, TX	05/14/2021		
Youth Debate League (MDG Gulf Coast, LLC)	Missouri City, TX	05/14/2021		
Z Smart, LLC	Rockwall, TX	05/14/2021		
Zen Insurance Services, LLC	Austin, TX	05/14/2021		
Zenith Designs, LLC	Houston, TX	05/14/2021		
ZNA DESIGN (ZNA GROUP LLC)	Katy, TX	05/14/2021		
ZolonTech, Inc.	Herndon, VA	05/14/2021		

---

External Invitations

Invite Email	Auto Approve	Invitation Date	Status	Status Date
Alix.Cethoute@UMB.com	No	05/14/2021	Invitation Sent	05/14/2021
amattson@bokf.com	No	05/14/2021	Invitation Sent	05/14/2021
bcolon@rwbaird.com	No	05/14/2021	Invitation Sent	05/14/2021
bshiels@gobaker.com	No	05/14/2021	Invitation Sent	05/14/2021
Clarence.Grier@rbccm.com	No	05/14/2021	Invitation Sent	05/14/2021
cwhitlock@samcocapital.com	No	05/14/2021	Invitation Sent	05/14/2021
Darci.Doneff@psc.com	No	05/14/2021	Invitation Sent	05/14/2021
david.cisarik@fhnfinancial.com	No	05/14/2021	Invitation Sent	05/14/2021
debi.jones@raymondjames.com	No	05/14/2021	Invitation Sent	05/14/2021
don@ehmuni.com	No	05/14/2021	Invitation Sent	05/14/2021
dwesterman@samcocapital.com	No	05/14/2021	Invitation Sent	05/14/2021
frank.reed@ubs.com	No	05/14/2021	Invitation Sent	05/14/2021
kellyd@ms.com	No	05/14/2021	Invitation Sent	05/14/2021
lisa.donnely@raymondjames.com	No	05/14/2021	Invitation Sent	05/14/2021
mark.pryce@citi.com	No	05/14/2021	Invitation Sent	05/14/2021
Mason.McWilliams@fhnfinancial.com	No	05/14/2021	Invitation Sent	05/14/2021
megan.sienty@hilltopsecurities.com	No	05/14/2021	Invitation Sent	05/14/2021
mike.weir@amegybank.com	No	05/14/2021	Invitation Sent	05/14/2021

---

### Participant Detail

#### @RISK Technologies

Address 16400 N. Dallas Pkwy Unit 105 Participation Type: Active Supplier  
Dallas, TX 75248

Invitation Date 05/14/2021  
Invitation Type Automatic  
Invitation Email(s)

#### 2 Inspire Peace

Address 1808 S. Good Latimer Expressway Participation Type: Active Supplier  
Dallas, TX 75226

Classifications MBE (Primary),SBE,WBE

Invitation Date 05/14/2021  
Invitation Type Automatic  
Invitation Email(s) 2inspirepeace@gmail.com

#### 2\*2\*4 Solutions Education Consulting Service

Address PO Box 2204 Participation Type: Active Supplier  
Red Oak, TX 75154

Invitation Date 05/14/2021  
Invitation Type Automatic  
Invitation Email(s) solution224@outlook.com

#### 365 Media (365 Media LLC)

Address 59 Deer St #517 Participation Type: Active Supplier  
Portsmouth, NH 03801

Invitation Date 05/14/2021  
Invitation Type Automatic  
Invitation Email(s) donpaulwrites@gmail.com

#### 365 Paving & Construction LLC

Address 1618 E. Griffin Parkway Participation Type: Active Supplier  
Mission, TX 78572

Invitation Date 05/14/2021  
Invitation Type Automatic  
Invitation Email(s) 365paving@gmail.com



**Harris County Department of Education  
Business Office /Purchasing Division  
Job (Bid-Proposal) Recommendation Form  
Program Review**

[This form is used to document due diligence by Recommendation Committee]

**To: Purchasing Division**

**From: Recommendation Committee**

**Dr. Jesus Amezcua  
Danielle Bartz  
Sarah Langlois  
Rosa Maria Torres**

*[Handwritten signatures in blue ink over horizontal lines]*

Job (Bid or RFQ#) and Name: 21/053KJ Financial Advisory Services for Harris County Department of Education and HCDE's Public Facility Corporation

Board Meeting Date: July 21, 2021

Date: July 7, 2021

**Procurement Requirements Available:**

Check One

- Under \$2,500 (Requires Division Director and Asst Supt. Approval)
- From \$2,500 to \$25,000 (Requires Buyer, Purchasing Director/CFO Approval)
- Over \$50,000 (Requires Board Approval)

I certify that I have reviewed the attached Job (bid, RFQ, RFP) and certify that all of my actions as a Recommendations Committee Member are within the procurement requirements in accordance with local Board Policies (CH local/legal) and legal (federal and state) policies and administrative guidelines set by the Business Office and Purchasing Division.

I certify that I have adhered to the Purchasing Policies of HCDE concerning the review of this job (bid or RFP) to include policies on conflict of interest (CIQ).

I certify that I am aware of all purchasing policies (CH Local and CH Legal) and administrative procedures of HCDE.

I certify that I am aware of the penalties of not following the purchasing policies and procedures and in specific with section 44.032 of the Texas Education Code which deals with the penalties related to sequential or component purchases.

I further certify that I recommend the issuance of a purchase order after Board approval and execution of a contract.









# HCDE RFQ 21 053KJ Financial Advisory Services PFC 7.7.21

Final Audit Report

2021-07-07

Created:	2021-07-07
By:	Jessica Bermea (jbermea@hcde-texas.org)
Status:	Signed
Transaction ID:	CBJCHBCAABAAKxqAscyT31WzIEQQKD2fnwWM7heSXuTs

## "HCDE RFQ 21 053KJ Financial Advisory Services PFC 7.7.21" History

-  Document created by Jessica Bermea (jbermea@hcde-texas.org)  
2021-07-07 - 9:11:46 PM GMT- IP address: 170.39.204.253
-  Document emailed to Sarah Langlois (slanglois@kbslawgroup.com) for signature  
2021-07-07 - 9:12:15 PM GMT
-  Email viewed by Sarah Langlois (slanglois@kbslawgroup.com)  
2021-07-07 - 9:56:32 PM GMT- IP address: 216.201.148.122
-  Document e-signed by Sarah Langlois (slanglois@kbslawgroup.com)  
Signature Date: 2021-07-07 - 9:57:34 PM GMT - Time Source: server- IP address: 216.201.148.122
-  Document emailed to Rosa Torres (rosamtorres@hcde-texas.org) for signature  
2021-07-07 - 9:57:36 PM GMT
-  Email viewed by Rosa Torres (rosamtorres@hcde-texas.org)  
2021-07-07 - 10:03:51 PM GMT- IP address: 172.58.97.224
-  Document e-signed by Rosa Torres (rosamtorres@hcde-texas.org)  
Signature Date: 2021-07-07 - 10:04:23 PM GMT - Time Source: server- IP address: 172.58.97.224
-  Agreement completed.  
2021-07-07 - 10:04:23 PM GMT

**Regular Board Meeting**

**8.F.8.**

**Meeting Date:** July 21, 2021

**Title:** Contract Award for Job No. 21/056YR Short Term Vocational Training Programs for Adult Education

**Submitted For:** Kendra Jackson, Purchasing

**Submitted By:** Yaritza Roman

**Recommended Action:** Approve

**HCDE Goal(s):**  
1. Impact education/respond to evolving needs  
4. Provide cost savings by leveraging tax dollars

**Additional Resource Personnel:** Dr. Jesus Amezcua, Dr. CJ Rodgers, Stephanie Ross, Kendra Jackson, and Yaritza Roman

**Facilities/Technology Approval Needed?:** None

**Information**

**Posted Agenda Item:**

**Approval of Contract Award for job no. 21/056YR Short Term Vocational Training Programs for Harris County Department of Education Adult Education Division with the following proposer(s):** Dellahniia; FocalPointK12, Inc.; Fuel Up For Life Foundation, Inc.; I'm Changing The Narrative, Inc.; Konnecting the Dots Developmental Institute; Launch Point CDC, Inc.; and U-Bridge Project Consulting Services for the period of 07/21/2021 through 07/20/2026, subject to annual appropriations of funding.

**Subject:**

Short Term Vocational Training Programs for the Adult Education Division.

**Rationale:**

The process enacted was a Request for Proposals (RFP) to acquire proposals from vendors to provide workforce certification trainings for the Harris County Department of Education Adult Education Division. Six hundred ninety (690) invitations were extended for proposals. Eight (8) responses were received from vendors. Each response was reviewed for compliance with the requirements of RFP, were evaluated, and scored. One (1) vendor was deemed as non-responsive, and seven (7) vendors offering the best value to HCDE/Adult Education were recommended for an award.

The contract period shall be for a term of five (5) years from 07/21/2021 through 07/20/2026 to the vendor stated above in Posted Agenda Item; subject to annual appropriations of funding. Contracts are in accordance with Texas Education Code 44.031.

**Fiscal Impact**

**Attachments**

- Evaluation Summary
- Board Recommendation
- ECI Form
- Participation Report

**Form Review**

**Inbox**  
Purchasing (Originator)

**Reviewed By**  
Kendra Jackson

**Date**  
06/30/2021 08:11 AM



**RFP 21/056YR Short Term Training Programs for HCDE Adult Education Division - Evaluation Summary**

<b>Evaluation Criteria</b>	<b>Total Weighted Value</b>	<b>Dellahniia</b>	<b>FocalPointK12, Inc.</b>	<b>Fuel Up For Life Foundation, Inc.</b>	<b>I'm Changing The Narrative, Inc.</b>	<b>Konnecting the Dots Developmental Institute</b>	<b>Launch Point CDC, Inc.</b>	<b>U-Bridge Project Consulting Services</b>
Price	35	31.25	27.50	31.25	28.25	27.00	18.25	28.25
Reputation of Vendor and Vendor's goods and/or service	20	16.50	19.25	18.75	18.75	17.25	18.25	18.00
Quality of Vendor's goods and/or services	20	20.00	19.50	18.75	18.50	15.00	20.00	18.25
Extent to which the goods and/or services meet HCDE needs	20	20.00	20.00	17.00	17.75	18.25	20.00	18.00
Vendor's past relationship with HCDE	5	1.25	5.00	4.75	5.00	4.75	1.25	5.00
Impact on Historically Underutilized Businesses	0	0.00	0.00	0.00	0.00	0.00	0.00	0.00
Total long-term cost to HCDE	0	0.00	0.00	0.00	0.00	0.00	0.00	0.00
For a contract for goods and services, other than goods and services related to telecommunications and information services, building construction and maintenance, or instructional materials, whether the Vendor or the Vendor's ultimate parent company or majority owner: (A) has its principal place of business in this state; or (B) employs at least 500 persons in this state	0	0.00	0.00	0.00	0.00	0.00	0.00	0.00
Other (Ability to allow other local government entities to piggy-back from this contract)	0	0.00	0.00	0.00	0.00	0.00	0.00	0.00
<b>Total Average</b>	<b>100</b>	<b>89.00</b>	<b>91.25</b>	<b>90.50</b>	<b>88.25</b>	<b>82.25</b>	<b>77.75</b>	<b>87.50</b>
		<b>RECOMMENDED</b>	<b>RECOMMENDED</b>	<b>RECOMMENDED</b>	<b>RECOMMENDED</b>	<b>RECOMMENDED</b>	<b>RECOMMENDED</b>	<b>RECOMMENDED</b>



**Harris County Department of Education  
 Business Office /Purchasing Division  
 Job (Bid-Proposal) **Recommendation Form**  
 Program Review**

[This form is used to document due diligence by Recommendation Committee]

---

**To: Purchasing Division**  
**From: Recommendation Committee**

**Stephanie Ross**  
**Linda Fehoko**  
**Denise R. Johnson**  
**Yaritza Román**

Job (Bid or RFP#) and Name: 21/056YR  
Short Term Vocational Training Programs for Harris County  
Department of Education Adult Education Division

Board Meeting Date: July 21, 2021

Date: June 22, 2021

**Procurement Requirements Available:**

Check One

- Under \$2,500 (Requires Division Director and Asst Supt. Approval)
- From \$2,500 to \$25,000 (Requires Buyer, Purchasing Director/CFO Approval)
- Over \$50,000 (Requires Board Approval)

I certify that I have reviewed the attached Job (bid or RFP) and certify that all of my actions as a Recommendations Committee Member are within the procurement requirements in accordance with local Board Policies (CH local/legal) and legal (federal and state) policies and administrative guidelines set by the Business Office and Purchasing Division.

I certify that I have adhered to the Purchasing Policies of HCDE concerning the review of this job (bid or RFP) to include policies on conflict of interest (CIQ).

I certify that I am aware of all purchasing policies (CH Local and CH Legal) and administrative procedures of HCDE.

I certify that I am aware of the penalties of not following the purchasing policies and procedures and in specific with section 44.032 of the Texas Education Code which deals with the penalties related to sequential or component purchases.

I certify that I am aware of the EDGAR requirements as amended on Dec. 26, 2014 under 2 CFR Part 200, and in specific the **conflict of interest requirements** for federal funds.

I certify that I am aware of Chapter 176 of the Local Government Code requirements for local government officers regarding **conflict of interest disclosures.**

I further certify that I recommend the issuance of a purchase order after Board approval and execution of a contract.

(Note: This form is required of all jobs (bids and RFPs) prepared by all Buyers & Director)

**Justification:**

Job no. 21/056YR

This RFP was developed to procure short term vocational training programs for the Adult Education Division.

**This job was competitively bid and advertised. The result of the bid generated the following responses:**

**Invitation to propose was sent to six hundred ninety (690) vendors.**

**HCDE received eight (8) responses.**

**Recommendation:**

**HCDE is recommending the following vendors for award:**

- **Dellahniia**
- **FocalPointK12, Inc.**
- **Fuel Up For Life Foundation, Inc.**
- **I'm Changing The Narrative, Inc.**
- **Konnecting the Dots Development Institute**
- **Launch Point CDC, Inc.**
- **U-Bridge Project Consulting Services**

## Harris County Department of Education Business Office /Purchasing Division

### EC Form

### Effectiveness and Compliance Review

[This form is used to document due diligence by Buyer]

---

To: Purchasing Audit File and Jesus J. Amezcua, Ph.D., CPA, Assistant Supt. for Business

From: Yaritza Román – Contract Manager

Job- Bid or RFP# and Name: 21/056YR Short Term Vocational Programs for Harris County Department of Education Adult Education Division

Board Meeting Date: July 21, 2021

Date: June 22, 2021

#### **Procurement Requirements Applicable:**

Check One

- Under \$2,500 (Requires Division Director and Asst Supt. Approval)  
 From \$2,500 to \$49,999 (Requires Buyer, Purchasing Director/CFO Approval)  
 Over \$50,000 (per CH Local)  
 Cooperative Programs (Requires Board Approval)

I certify that I have reviewed the attached job (bid or RFP) and certify that all of my actions as a Recommendations Committee Member are within the procurement requirements in accordance with local Board Policies (CH local/legal) and legal (federal and state) policies and administrative guidelines set by the Business Office and the Purchasing Division.

I certify that I have adhered to the Purchasing Policies of HCDE concerning the review of this job (bid or RFP) to include policies on conflict of interest.

I certify that I am aware of all purchasing policies (CH Local and CH Legal) and administrative procedures of HCDE.

I certify that I am aware of the penalties of not following the purchasing policies and procedures and in specific with section 44.032 of the Texas Education Code which deals with the penalties related to sequential or component purchases.

I certify that I am aware of the EDGAR requirements as amended on Dec. 26, 2014 under 2 CFR Part 200, and in specific the **conflict of interest requirements** for federal funds.

I certify that I am aware of Chapter 176 of the Local Government Code requirements for local government officers regarding **conflict of interest disclosures.**

I further certify that I recommend the issuance of a purchase order after Board approval and execution of a contract.

(Note: This form is required of all jobs (bids and RFPs) prepared by all buyers and Director)

---

# Harris County Department of Education

## Participation Detail as of 6/29/2021 12:28:31 PM (CT)

### Bid Information

Bid Creator	Yaritza Roman
Email	yroman@hcde-texas.org
Phone	(713) 696-8212
Fax	
Bid Number	21/056YR
Title	Short Term Vocational Training Programs for Harris County Department of Education Adult Education Division
Bid Type	Request for Proposal
Issue Date	5/14/2021 11:20 AM (CT)
Close Date	6/8/2021 02:00:00 PM (CT)

### Participation Summary

Company Name	City, State	Invitation Date	Status	Status Date	Response Date
2 Inspire Peace	Dallas, TX	05/14/2021			
2*2*4 Solutions Education Consulting Service	Red Oak, TX	05/14/2021			
365 Paving & Construction LLC	Mission, TX	05/14/2021			
3rd I Process FX	Houston, TX	05/14/2021			
3W Consulting Group LLC (Rochelle L. Webb)	Cross Roads, TX	05/14/2021			
4.0 GPA	Houston, TX	05/14/2021			
400 Voices	Houston, TX	05/14/2021			
4142 Youth Development Services	ROSHARON, TX	05/14/2021			
4kboards	Keller, TX	05/14/2021			
4W Solutions, Inc	Houston, TX	05/14/2021			
7Mindsets	Roswell, GA	05/14/2021			
806 Technologies, Inc.	Plano, TX	05/14/2021			
A & R Holdings, LLC	Jacksonville, FL	05/14/2021			
A,N,H. Consulting, LLC.	New Orleans, LA	05/14/2021			
A.I.M. (Assessment Intervention Management, LLC)	San Antonio, TX	05/14/2021			
AAA Painting	Houston, TX	05/14/2021			
Abundance Educational Consulting, LLC	Humble, TX	05/14/2021			
AC Language School (Chavez & Associates)	Sugar Land, TX	05/14/2021			
Academia in Motion, Inc	Houston, TX	05/14/2021			
Academic Learning Company (Velazquez Press)	El Monte, CA	05/14/2021			
ACS Engineering & Safety	Spring, TX	05/14/2021			
AdaptiveX (Test4Me LLC)	Glenarden, MD	05/14/2021			
Adira LLC	Savannah, TX	05/14/2021			
AdjuStar Services, Inc.	Houston, TX	05/14/2021			
ADMORE BEHAVIORAL THERAPY	Houston, TX	05/14/2021			
AGL (Accompanied by God's Love, Inc)	Houston, TX	05/14/2021			
Ahead Of The Class Educational Services, Inc.	Richmond, TX	05/14/2021			
Alamo Music Center, Inc.	San Antonio, TX	05/14/2021			
Alba Educational Consulting, LLC	Kingwood, TX	05/14/2021			
ALL AMERICAN SPECIALTY CONSTRUCTION LLC	IRVING, TX	05/14/2021			
All Educate Learning Resources	Livingston, TX	05/14/2021			
ALL VALLEY DRUG SCREENS	Brownsville, TX	05/14/2021			
Alliance Financial Ministries, Inc.	Pearland, TX	05/14/2021			
AlphaGraphics (Lukitas Inc.)	Houston, TX	05/14/2021			
ALTERING THE EDUCATION XPECTATION LLC	Evanston, IL	05/14/2021			
Altitude Learning (AltSchool, PBC d/b/a Altitude Learning)	San Francisco, CA	05/14/2021			
Amanda Holdsworth Communications	South Lyon, MI	05/14/2021	Viewed	05/14/2021	
Amanda Morgan, Not Just Cute (Amanda Morgan)	Olalla, WA	05/14/2021			

American Institutes for Research (American Insitutes for Research in the Behavioral Sciences)	Washington, DC	05/14/2021			
American Productivity & Quality Center	Houston, TX	05/14/2021			
Anew Psychological Services, PLLC	Houston, TX	05/14/2021			
AnLar, LLC	Arlington, VA	05/14/2021			
Ann Marie Harbour	Richmond, TX	05/14/2021			
Anthropology Arts (Voices Advance LLC DBA anthropology arts)	Brooklyn, NY	05/14/2021			
Apple Developmental Health	Houston, TX	05/14/2021			
Aquilla Educational Resources	FORNEY, TX	05/14/2021			
ardurra group	houston, TX	05/14/2021			
Argument-Driven Inquiry	Austin, TX	05/14/2021			
ARRAY	Bellaire, TX	05/14/2021			
Arts Alive! Inc (ARTS ALIVE!)	Houston, TX	05/14/2021			
As We Grow Learning Center	Houston, TX	05/14/2021			
ASAP Roofing (Koppel & Kozel, LLC)	Tyler, TX	05/14/2021			
ASmart Consulting	Houston, TX	05/14/2021			
Aspire Works LLC	San Antonio, TX	05/14/2021			
Assoc for the Advancement of Mexican Americans (AAMA)	Houston, TX	05/14/2021			
Astrov & Associates	Frisco, TX	05/14/2021			
AT&T Mobility LLC	Bellaire, TX	05/14/2021			
Athena Scholastic, LLC	Vero Beach, FL	05/14/2021			
Atkins Powerhouse Consulting LLC	Fort Worth, TX	05/14/2021			
AUSTIN LEARNING CENTER (CANDEO, LLC)	AUSTIN, TX	05/14/2021			
B Dow (Elizabeth Dow)	Richmond, TX	05/14/2021			
Baked With Confidence	Houston, TX	05/14/2021			
Barstone, Inc.	San Antonio, TX	05/14/2021			
BCA DX LABORATORY	Livingston, TX	05/14/2021			
BCS Consulting	Humble, TX	05/14/2021			
BE GLAD LLC	San Jose, CA	05/14/2021			
Bearing Fruit Early Childhood Training	HOUSTON, TX	05/14/2021			
Bedden & Associates, LLC (Bedden)	Richmond, VA	05/14/2021			
Bee Busy Wellness Center	Houston, TX	05/14/2021			
Bell and Smarts	Broken Arrow, OK	05/14/2021			
BellXcel	Westwood, MA	05/14/2021			
BEM Solutions, LLC	Kansas City, MO		Submitted	06/07/2021	06/07/2021
BenCheri Educational Center	Houston, TX	05/14/2021			
Benchmark Education Company	New Rochelle, NY	05/14/2021			
Bertha L. St. John /Solid Rock Speech Language Clinic	Fresno, TX	05/14/2021			
Best Practice Associates, Inc.	Houma, LA	05/14/2021			
Black Topaz Consulting	Austin, TX	05/14/2021			
BlackBeltHelp	Chicago, IL	05/14/2021			
Blocker Education Research, LLC (Tyrone D. Blocker)	Austin, TX	05/14/2021			
BLU PHIRE RESEARCH INSTITUTE INC	HOUSTON, TX	05/14/2021			
BluGreen Pest Control	Wallis, TX	05/14/2021			
BMHR - Better Man HR LLC	SAN ANTONIO, TX	05/14/2021			
BookerDezigns	Richmond, TX	05/14/2021			
Bookwhisperer, Inc. (Donalyn Miller)	Colleyville, TX	05/14/2021			
Boundaryless Enterprises, LLC	Houston, TX	05/14/2021			
Boykins Youth Foundations	Houston, TX	05/14/2021			
Boys and Girls Clubs of Greater Houston	Houston, TX	05/14/2021			
Bracane Company	Plano, TX	05/14/2021			
BrainStorm Advanced Learning Systems	Mansfield, TX	05/14/2021			
Brandi Spencer Consulting	Spring, TX	05/14/2021			
Brandi T. Brown	Manvel, TX	05/14/2021			
Brandon Miller	Houston, TX	05/14/2021			
Briar Patch	Houston, TX	05/14/2021			
Bridge to Leadership, LLC	Missouri City, TX	05/14/2021			
Bright Ideas	Jersey Village, TX	05/14/2021			
BrightBytes	San Francisco, CA	05/14/2021			
Brighter Futures Counseling and Consulting	Houston, TX	05/14/2021			
Building Solutions	dallas, TX	05/14/2021			
bulb Inc.	Lafayette, CO	05/14/2021			

Bureau of Education & Research	Bellevue, WA	05/14/2021		
Burgeon IT Services LLC	Wilmington, DE	05/14/2021		
BUSINESS 101 CONSULTANTS & TRAINERS	Houston, TX	05/14/2021	Viewed	06/07/2021
BUTTON UP GLOBAL	Houston, TX	05/14/2021		
ByHearing, LLC	Houston, TX	05/14/2021		
C Change Consulting	Houston, TX	05/14/2021		
C1S Group, Inc.	Dallas, TX	05/14/2021		
CALPAA Inc (CALPAA, Inc)	Seattle, WA	05/14/2021		
Caperton-Brown & Poole Consulting	Ft. Pierce, FL	05/14/2021		
Capitol Region Education Council	Hartford, CT	05/14/2021		
Catapult Dreams, LLC	Pearland, TX	05/14/2021		
Catapult Learning	Camden, NJ	05/14/2021		
CBRE   Heery (CBRE Heery, Inc.)	Houston, TX	05/14/2021		
CBTS Technology Solutions	Cincinnati, OH	05/14/2021		
Center for Student Achievement Solutions	New York, NY	05/14/2021		
Center for the Collaborative Classroom	Alameda, CA	05/14/2021		
Certica Solutions	Wakefield, MA	05/14/2021		
Character You!	Manvel, TX	05/14/2021		
CharacterStrong, LLC	PUYALLUP, WA	05/14/2021		
Chart Chicks LP	Lufkin, TX	05/14/2021		
Chase in Dreams, Speech and Drama (Deadra Chase)	Houston, TX	05/14/2021		
CHAT (Culture of Health-Advancing Together)	Houston, TX	05/14/2021		
Cheryl R. Vital	Crosby, TX	05/14/2021		
Child Care Associates	FORT WORTH, TX	05/14/2021		
Child Care Council (Child Care Council of Greater Houston Inc.)	Houston, TX	05/14/2021		
Child Trends	Bethesda, MD	05/14/2021		
Childcare Masters LLC	Cypress, TX	05/14/2021		
Cindy Puryear Consulting Services (Cindy Puryear)	Houston, TX	05/14/2021		
cLI-Energy and Construction LL	Houston, TX	05/14/2021		
Club SciKidz Houston (Heir Consulting Group)	Houston, TX	05/14/2021		
Coach Mercer LLC	Katy, TX	05/14/2021	Viewed	05/17/2021
Coatings Specialty Development Lab	Cypress, TX	05/14/2021		
Code Park Inc	Houston, TX	05/14/2021		
Cognia	Alpharetta, GA	05/14/2021		
Cognixia (Cognixia Inc)	Basking Ridge, NJ	05/14/2021		
CohnReznick LLP	Austin, TX	05/14/2021		
Collaborate With Christina	Houston, TX	05/14/2021	Viewed	05/18/2021
Collaborative for Children	Houston, TX	05/14/2021		
Color of Life (Color of Life Community Resource & Activity center)	Houston, TX	05/14/2021		
Comflow Mechanical Services	Houston, TX	05/14/2021		
Community Training and Assistance Center, Inc.	Boston, MA	05/14/2021		
Construction Journal	Stuart, FL	05/14/2021		
CoolSpeak, LLC	Pottstown, PA	05/14/2021		
Corwin Press, a SAGE Company	Thousand Oaks, CA	05/14/2021		
Cossey's Services, LLC	The Woodlands, TX	05/14/2021		
Covid Safety Glass (Silent West LLC)	LAS VEGAS, NV	05/14/2021		
CPS HR Consulting (Cooperative Personnel Services)	Sacramento, CA	05/14/2021		
Creative Concepts for Early Learning (Latanya Elizabeth Atherley)	Converse, TX	05/14/2021		
Creative Trainers and Consultants	Houston, TX	05/14/2021		
Creatively Inspired Communications (ConSandra Jones)	Austin, TX	05/14/2021		
CReed Global Enterprises (CReed Global Media & Production)	Houston, TX	05/14/2021		
Crimson Vision Enterprises	Dickinson, TX	05/14/2021		
Cyclone FPV (Cyclone 3D, Inc.)	Spring, TX	05/14/2021		
D & S Educational Consulting (Stephanie Ross)	Houston, TX	05/14/2021		
D. Mark Wallace	McAllen, TX	05/14/2021		
Dan St. Romain Educational Consulting, LLC	Universal City, TX	05/14/2021		
Danny Steele (Daniel J. Steele)	Birmingham, AL	05/14/2021		
David P. Weikart Center for Youth Program Quality (The Forum for Youth Investment)	Washington, DC	05/14/2021		

David Rodriguez	San Antonio, TX	05/14/2021			
David Santana	Houston, TX	05/14/2021			
Debbie Diller & Associates, Inc.	Houston, TX	05/14/2021			
Decisions	Houston, TX	05/14/2021			
DeDe Church & Associates, LLC	AUSTIN, TX	05/14/2021			
Defined Learning	Northbrook, IL	05/14/2021			
Dellahniia (Deytra Brown)	Katy, TX		Submitted	06/03/2021	06/03/2021
DEMS,LLC	Houston, TX	05/14/2021			
Development Without Limits	New York, NY	05/14/2021			
DGR United	houston, TX	05/14/2021			
Disciplers Inc	Spring, TX	05/14/2021			
DoLogic Inc.	Annandale, VA	05/14/2021			
Dorsey Management Services	Lewisville, TX	05/14/2021			
dougie-fresh (Dr. Douglas L. Garner)	North Las vegas, NV	05/14/2021			
Dr. Jeanne M. Hines	Port Arthur, TX	05/14/2021			
Dr. Mary E. White International, LLC	Houston, TX	05/14/2021			
Dr. Mike!	Wimberey, TX	05/14/2021			
DR. PATRICIA MORALES ELLSERVICES	THE WOODLANDS, TX	05/14/2021			
Dr. Pope's STEM and Liberal Arts Academy	Pearland, TX	05/14/2021			
DrB!Real Educational Services	Houston, TX	05/14/2021			
Dream Capital International, Inc	Houston, TX	05/14/2021			
Dream Catcher Learning Academy	Humble, TX	05/14/2021			
Dual Point Education	Houston, TX	05/14/2021			
DYS HOUSYON YOUTH ASSOCIATION	Houston, TX	05/14/2021			
E3 Alliance	Austin, TX	05/14/2021			
Early Start Development Inc	Humble, TX	05/14/2021			
E-Colors in Education	Austin, TX	05/14/2021			
edOpp Solutions LLC	Houston, TX	05/14/2021			
EDU Specialist, LLC	Lake Dallas, TX	05/14/2021			
Educate To Edify (Educating White Black)	Pearland, TX	05/14/2021			
Education & Business Associates, Inc.	DeSoto, TX	05/14/2021			
Education Elements, Inc.	South San Francisco, CA	05/14/2021	No Bid	05/14/2021	05/14/2021
Education Solutions Now, LLC	Houston, TX	05/14/2021			
Educational Epiphany LLC	WASHINGTON, DC	05/14/2021			
Educational Leadership Consultants	Houston, TX	05/14/2021			
Educational Systems Consulting	Binghamton, NY	05/14/2021			
EducationDesigns Unlimited Services, LLC	North Plainfield, NJ	05/14/2021	Viewed	05/14/2021	
Edwards Sutarwalla PLLC	Houston, TX	05/14/2021			
Elegant Enterprise Wide Solutions, Inc.	Chantilly, VA	05/14/2021			
Elisa Rankin Consulting LLC	Uvalde, TX	05/14/2021			
Ellington Chastain Educational Initiative	San Antonio, TX	05/14/2021			
Emdin Support Services LLC	Bronx, NY	05/14/2021			
Emergent Tree Education	Austin, TX	05/14/2021			
Emma Oliver	Houston, TX	05/14/2021			
Empowered Network Services, LLC	Huffman, TX	05/14/2021			
Energy Saving Advisor Distributors	Dallas, TX	05/14/2021			
engage2learn (Engage! Learning, Inc. dba engage2learn)	Portland, TX	05/14/2021			
Engaged Escapades	Houston, TX	05/14/2021			
Engaging Learners, LLC (Katherine S. McKnight)	Antioch, IL	05/14/2021			
Ensemble Learning (The College Ready Promise)	Austin, TX	05/14/2021			
Enterprise Pals, Inc.	Olathe, KS	05/14/2021			
Epic Decisions, LLC	Kingwood, TX	05/14/2021			
ESL INTERNATIONAL, LLC	El Paso, TX	05/14/2021			
Essential Wellness and Balance	Missouri City, TX	05/14/2021			
eTeachingMe (Love N Learn At Home)	Georgetown, TX	05/14/2021			
Etrainers.org	Machesney Park, IL	05/14/2021			
eTutorsZone LLC	Apex, NC	05/14/2021			
Evergreen Solutions, LLC	Tallahassee, FL	05/14/2021			
Exceptional Pediatric Therapy, LLC	Houston, TX	05/14/2021			
ExecuTeam Staffing	Houston, TX	05/14/2021			
ExerPlay, Inc	Cedar Crest, NM	05/14/2021			
Exploros (Exploros, Inc.)	Wayland, MA	05/14/2021			
Faith Works Consulting Group, LLC	Houston, TX	05/14/2021			
Fast Forward	Las Vegas, NV	05/14/2021			
Favor Consulting Inc (Demlan Solutions Inc)	Southlake, TX	05/14/2021			
Fazzio Consulting, LLC.	Round Rock, TX	05/14/2021			



Felicity Educational Services	Deerfield, IL	05/14/2021			
Ferrilli	Haddonfield, NJ	05/14/2021			
Fig Restoration	houston, TX	05/14/2021	Unsubmitted	06/03/2021	
FIRST Educational Resources, LLC	Winneconne, WI	05/14/2021			
Floral Park Consulting LLC	Floral Park, NY	05/14/2021			
FOCALPOINTK12, INC.	Norcross, GA	05/14/2021	Submitted	06/08/2021	06/08/2021
For The Culture Literacy Development	Humble, TX	05/14/2021			
Forged Ed	Houston, TX	05/14/2021			
Fostering Stars Learning & Resource Center, Inc	Houston, TX	05/14/2021			
Fragile Planet Wildlife Center	Harlingen, TX	05/14/2021			
Freese and Nichols, Inc.	Fort Worth, TX	05/14/2021			
Friends of the British Council USA Inc.	Washington, DC	05/14/2021			
From The Ground up Performance Enhancement (Deanna Voltz)	Houston, TX	05/14/2021			
From The Heart International Educational Services	Nashville, TN	05/14/2021			
Frontier Services Group	Houston, TX	05/14/2021			
Fuel Up For Life Foundation Inc	FRESNO, TX		Submitted	05/31/2021	05/31/2021
Fundamentals	Pearland, TX	05/14/2021			
Furness Law	Houston, TX	05/14/2021			
G4C Enterprises, LLC	Pflugerville, TX	05/14/2021			
Gary Polland P.C.	Houston, TX	05/14/2021			
Gastile Consultant Group	Houston, TX	05/14/2021			
Gazelle Capital, LLC	Saint Petersburg, FL	05/14/2021			
Generation Ready	New York, NY	05/14/2021			
Generation Teach Inc.	Boston, MA	05/14/2021			
Gene's Machine, INC.	Victoria, TX	05/14/2021			
Genesis Education and Training (Erica Washington)	Wharton, TX	05/14/2021			
Gentle Minds Tutoring	Missouri City, TX	05/14/2021			
German Consulting and Resources, LLC (Felecia German)	Sugarland, TX	05/14/2021			
GermBlast (Infection Controls, Inc.)	Lubbock, TX	05/14/2021			
Getting Sorted (G. Yess Fisher & Co., LLC)	The Woodlands, TX	05/14/2021			
Giftng Grounds	Houston, TX	05/14/2021			
Gilberto D. Soto	Laredo, TX	05/14/2021			
GilCat Solutions (Gloria Lastra)	Spring, TX	05/14/2021			
Girlstart	Austin, TX	05/14/2021			
Glass View of Tech	Spring, TX	05/14/2021			
Glenrock Consulting, LLC	Long Beach, CA	05/14/2021			
GLOBAL EDUCATIONAL SOLUTIONS LLC	Canton, MI	05/14/2021			
GMC CONSULTANTS,LLC	Houston, TX	05/14/2021			
GOD FEARING POWER HOUSE (POWER ROCK COMMUNITY CENTR)	HOUSTON, TX	05/14/2021			
Golden Mountain Consulting L.L.C	Houston, TX	05/14/2021			
Golding Touch Education Consul	Manvel, TX	05/14/2021			
GO-Strategic Management Services	Houston, TX	05/14/2021			
GovSense	Alpharetta, GA	05/14/2021			
GPR Ventures, LLC	Montgomery, TX	05/14/2021	Viewed	05/26/2021	
Gray Mechanical (Gray Mechanical, LLC)	Houston, TX	05/14/2021			
Greatest in the Kingdom Ministries	The Woodlands, TX	05/14/2021			
Greg Garrett	Sugarland, TX	05/14/2021			
Grow Minds Consulting LLC	HOUSTON, TX	05/14/2021			
GW Implementation Solutions	Nokomis, FL	05/14/2021			
Harmony Public Schools	Houston, TX	05/14/2021			
Heartwork Trending Counseling and Consulting, PLLC (Heartwork Trending Consulting Services)	Houston, TX	05/14/2021			
Heavenly Service, LLC	Webster, TX	05/14/2021			
Helping All Leaders Obtain Success (HALOS) (Helping All Leaders Obtain Success)	Homewood, IL	05/14/2021			
Henry Deslaurier	Houston, TX	05/14/2021			
Herrera Talent Strategies LLC	Houston, TX	05/14/2021			
HiMac Center for Creative Thinking	Humble, TX	05/14/2021			
Holland Energy Consulting	Houston, TX	05/14/2021			
Holtz/Adams Construction and Consulting, LLC	Universal City, TX	05/14/2021			
Honor Moorman Consulting	Brazoria, TX	05/14/2021			
Hooper Strategies	Granbury, TX	05/14/2021			

Hope Over Hurt	Houston, TX	05/14/2021			
HORIZON SW PROPERTIES	SUGAR LAND, TX	05/14/2021			
Houghton Mifflin Harcourt Publishing Company	Geneva, IL	05/14/2021			
Houston A+ Challenge	Houston, TX	05/14/2021	Viewed	05/21/2021	
Houston Urban Debate League	Houston, TX	05/14/2021			
HRchex, LLC (Intellisoft II, Inc.)	Irving, TX	05/14/2021			
HTEC-Houstons Training and Education Center, Inc. (Phillips)	Houston, TX	05/14/2021			
Hunt, Guillot & Associates	Baton Rouge, LA	05/14/2021			
I AM Transition Community Foundation, Inc.	Humble, TX	05/14/2021			
IA-Advanced Telecom Solutions, LLC	Richmond, TX	05/14/2021	Viewed	05/16/2021	
IdentifIE Special Education, LLC	Houston, TX	05/14/2021			
IgnitED	Spring, TX	05/14/2021			
Illuminate Education	Irvine, CA	05/14/2021			
I'm Changing The Narrative INC	Yulee, FL	05/14/2021	Submitted	06/08/2021	06/08/2021
Imagine Excellence.Inc	Houston, TX	05/14/2021			
Imagine Me Academy	Crosby, TX	05/14/2021			
Immaculate Kids	Houston, TX	05/14/2021			
IMPACT 360	Missouri City, TX	05/14/2021			
IMS Dodge	San Diego, CA	05/14/2021			
Indatatech (Instant Data Technologies, Inc.)	San Antonio, TX	05/14/2021			
Indigo Education Company (Watershed, Inc)	Niwot, CO	05/14/2021			
Infinite Education Solutions	Desoto, TX	05/14/2021			
Infinite Solutions Enterprises (The DDance Group, Inc.)	Glen Allen, VA	05/14/2021			
Infojini,Inc.	Columbia, MD	05/14/2021			
Ink International	Lawrenceville, GA	05/14/2021			
InnerChange Consulting Group	Houston, TX	05/14/2021			
Innovation Bridge, Inc.	Sacramento, CA	05/14/2021			
Innovative Texas Strategies LLC	Houston, TX	05/14/2021			
InnovsiteLLC	Decatur, GA	05/14/2021			
Institute for Building Technology and Safety	VA, VA	05/14/2021			
International Write Now, Inc	Missouri City, TX	05/14/2021			
Interprise/Southwest Interior & Space Planning, In	Addison, TX	05/14/2021			
Invo Healthcare Associates (Invo Healthcare Associates, LLC)	Jamison, PA	05/14/2021			
IPM Asset Solutions, Inc.	Houston, TX	05/14/2021			
I-Raos, Inc	Pearland, TX	05/14/2021			
ISE International Group	Bethesda, MD	05/14/2021			
Its Your Time To Flourish	Houston, TX	05/14/2021			
iWRITE (I Write)	Houston, TX	05/14/2021			
JC Stonewall Constructors, LP	Houston, TX	05/14/2021			
Jean Polichino Consulting, LLC	Fredericksburg, TX	05/14/2021			
Jennifer Michelle Weeks	Cypress, TX	05/14/2021			
Jennifer Serravallo Consulting, LLC	South Orange, NJ	05/14/2021			
JER HR Group LLC	New York, NY	05/14/2021			
Jerry Gaither Enterprise	HOUSTON, TX	05/14/2021			
Jigsaw Learning LLC (TeachTown)	Woburn, MA	05/14/2021			
JJ's I'm Me Foundation	Houston, TX	05/14/2021	Viewed	05/21/2021	
JL Hinds Consulting LLC (Hinds)	San Antonio, TX	05/14/2021			
Jocelyn A Chadwick,PhD (Jocelyn A. Chadwick)	Arlington, MA	05/14/2021			
John SanGiovanni	Westminster, MD	05/14/2021			
Johnson Consulting (Adrian B. Johnson)	Houston, TX	05/14/2021			
Jon M. Warren, LLC	Decatur, TX	05/14/2021			
Jones Lang LaSalle (JLL)	Houston, TX	05/14/2021			
Joyce Davis/Erin Whitney	Houston, TX	05/14/2021			
JRC & Associates, Educational Consultant Services	Houston, TX	05/14/2021			
JS&D Sports Development Outreach Ministries	Humble, TX	05/14/2021			
K&R Group, INC	Houston, TX	05/14/2021			
K12 Food Pros	La Mesa, CA	05/14/2021			
K12 Insight	Herndon, VA	05/14/2021			
Kagan Publishing & Professional Development	San Clemente, CA	05/14/2021			
Kaplan Early Learning Company	Lewisville, NC	05/14/2021	Viewed	05/14/2021	
KATTA INFOTEK INC	HOUSTON, TX	05/14/2021			
KCP Educational Consulting (Kristi Clarkson Pharaon)	Brenham, TX	05/14/2021			

Keye Group LLC	Rosharon, TX	05/14/2021			
Kennesaw State University iTeach (Elkins Pointe MS)	Kennesaw, GA	05/14/2021			
Keter Environmental Services	Indianapolis, IN	05/14/2021			
Keys to Literacy	Rowley, MA	05/14/2021			
KGBTexas Communications	Houston, TX	05/14/2021			
KH Literacy Education LLC (Kristen Leanne Henry)	San Antonio, TX	05/14/2021			
Kickboard, Inc.	New Orleans, LA	05/14/2021			
Kidsfit (ED PINNEY LLC)	HUGER, SC	05/14/2021			
Kijo Consulting LLC	Houston, TX	05/14/2021			
Kiln Services of North Texas	Highland Village, TX	05/14/2021			
Kingham Dalton Wilson, Ltd.	Houston, TX	05/14/2021			
KLD PLAYSCAPES USA (TWO WORD COMPANY LLC)	Boca Raton, FL	05/14/2021			
KMD Hospitality (KMD Hospitality LLC)	Humble, TX	05/14/2021			
Konnecting the Dots	Houston, TX	05/14/2021	Submitted	06/06/2021	06/06/2021
KTM Educational Consulting, LLC	San Antonio, TX	05/14/2021			
L&S Associates, LLC	Montgomery, TX	05/14/2021			
L.SMURPHE.F Institute; Solutions by L.SMURPHE.F; L.SMURPHE.F Productions (L.SMURPHE.F Enterprises, Ltd. Co.)	League City, TX	05/14/2021			
Lady Liberty Group LLC	Eules, TX	05/14/2021			
Lan Nguyen	Houston, TX	05/14/2021			
Lantana Communications	Arlington, TX	05/14/2021			
LATT Evaluations and Services, PLLC (La Shaun Arzu, PLLC)	Houston, TX	05/14/2021			
Launch Point CDC, Inc.	Houston, TX	05/14/2021	Submitted	06/08/2021	06/08/2021
LaVondia Menephee	Houston, TX	05/14/2021			
LBNM Corporation	Richmond, TX	05/14/2021			
LEAD Educational Services (William Price)	Missouri City, TX	05/14/2021			
Lead Your School (Blue Daisy Consulting, LLC)	Midland, TX	05/14/2021	No Bid	05/27/2021	05/27/2021
lead4ward, LLC	Plano, TX	05/14/2021	No Bid	06/07/2021	06/07/2021
Leadership ConsultingGroup, Inc.	Houston, TX	05/14/2021			
Leading School Learning	Cypress, TX	05/14/2021			
LEAPS AND BOUNDS TUTORIAL CENTERS (Tutorials by Leaps and Bounds)	Houston, TX	05/14/2021			
Learning Forward	Dallas, TX	05/14/2021			
Learning Omnivores (William Sommers)	Austin, TX	05/14/2021			
Lee Rutledge Consulting (Rutledge)	Austin, TX	05/14/2021			
Legends Do Live	Missouri City, TX	05/14/2021			
Levy's Tutorial and Enrichment Center (Mary Baumann)	Houston, TX	05/14/2021	No Bid	05/28/2021	05/28/2021
Libra-Tech Corporation	Argyle, TX	05/14/2021			
LightSail, Inc.	New York, NY	05/14/2021			
Lisa K Bailey	Missouri City, TX	05/14/2021	Viewed	05/25/2021	
Look to Success, LLC (Michelle Lee Pina)	Houston, TX	05/14/2021			
Love 2 the Max	Houston, TX	05/14/2021			
Lovescaping LLC	Houston, TX	05/14/2021			
Lowes Companies Inc	Mooresville, NC	05/14/2021			
LQI Consulting Group, LLC	Round Rock, TX	05/14/2021			
L-Sync, LLC	Grand Prairie, TX	05/14/2021			
Luchin Educational Consulting (Beatrice Moore Luchin)	Houston, TX	05/14/2021			
Lucy Anderson	Houston, TX	05/14/2021			
Lynn Gomes, LLC (Lynn Gomes)	Houston, TX	05/14/2021			
M&H Lighting Systems (Mapenzi Group)	Pearland, TX	05/14/2021			
M.E.N. (Mentoring, Educating & Nurturing) Incorporated (MEN Inc.)	Houston, TX	05/14/2021	No Bid	05/14/2021	06/07/2021
M3 Inc	Brooklyn, NY	05/14/2021			
Main Stop Testing Svcs	Houston, TX	05/14/2021			
Main Street Pilot, Inc.	Dallas, TX	05/14/2021			
Maker Education Inc	Houston, TX	05/14/2021			
Malor & Company Inc	New York, NY	05/14/2021			
MangesConsulting,LLC	Rowlett, TX	05/14/2021			
Mark Collins Construction LLC	League City, TX	05/14/2021			
Mark Matranga	Fort Worth, TX	05/14/2021			

Marketing Addiction Inc.	Houston, TX	05/14/2021	
Marvelous University	Dallas, TX	05/14/2021	
Mary Benton Communications and Public Affairs	Houston, TX	05/14/2021	
Mary Lynn Johnson	Spring, TX	05/14/2021	
Marzano Research, LLC	Bloomington, IN	05/14/2021	
Maxim Healthcare Staffing Services, Inc.	San Luis Obispo, CA	05/14/2021	
MAXIMUS	Reston, VA	05/14/2021	
MCA Communications	Houston, TX	05/14/2021	
McGraw Hill LLC	Columbus, OH	05/14/2021	
MCP Professional Services (Dr. Deloris L. Nelson)	Houston, TX	05/14/2021	
McREL International	Denver, CO	05/14/2021	
Medixsoft Inc	Lewisville, TX	05/14/2021	
Melba Figueroa (HonestRx Consulting LLC)	Southlake, TX	05/14/2021	
MERCER TECHNOLOGIES FIRM	Gary, IN	05/14/2021	
Metamorphosis Concepts	Manvel, TX	05/14/2021	
MetriTech, Inc.	Champaign, IL	05/14/2021	
Microburst Learning, LLC	Columbia, SC	05/14/2021	
Milestone Education, LLC	Lawrenceville, GA	05/14/2021	
Millennium Learning Concepts	Lexington, KY	05/14/2021	
Millunzi & Associates	The Woodlands, TX	05/14/2021	
Mind Your Gaps	Plano, TX	05/14/2021	
Mitaja Corporation	Fulton, MD	05/14/2021	
MMECA (1968)	Missouri City, TX	05/14/2021	
Moore Counseling and Psychological Services (Lorenzo Moore)	Houston, TX	05/14/2021	
MPACT STRATEGIC CONSULTING, LLC	Houston, TX	05/14/2021	
MSys inc	washington, DC	05/14/2021	
myON, LLC	Bloomington, MN	05/14/2021	
Namitzi Yoga (Mitzi Henderson)	HOUSTON, TX	05/14/2021	
Nasare Enterprises,LLC.	Houston, TX	05/14/2021	
National Academic Educational Partners Inc.	Miami Lakes, FL	05/14/2021	
National Training Network, Inc.	Greensboro, NC	05/14/2021	
NationSync (NationSync Corporation)	Houston, TX	05/14/2021	
Nazca Technologies and Consulting LLC	MONTGOMERY, TX	05/14/2021	
NEDRP, LLC (RD360 EDUCATIONAL CONSULTING)	Canyon Lake, TX	05/14/2021	
NEUFELD LEARNING SYSTEMS INC.	LONDON, ON	05/14/2021	
New Spectrum Educational Consultants (Civil Society Educational Consultants)	Houston, TX	05/14/2021	
New Teacher Center	Santa Cruz, CA	05/14/2021	
Nichelle Pinkney, The Urban Scholar, Independent Consultant (Nichelle Pinkney)	Houston, TX	05/14/2021	
Niroga Institute	Oakland, CA	05/14/2021	
no bully here	PASADENA, TX	05/14/2021	
NO EGO APPAREL (NO EGO INC)	AUSTIN, TX	05/14/2021	
Nurture to Blossom Services, Inc.	Houston, TX	05/14/2021	
Nuvalo LLC	Gig Harbor, WA	05/14/2021	
Nylinka School Solutions	Kensington, MD	05/14/2021	
Oak Hill Technology, Inc.	Driftwood, TX	05/14/2021	
Odigo Services LLC	Houston, TX	05/14/2021	
O'Hanlon, Demerath & Castillo	Austin, TX	05/14/2021	
Ondi Love Center Ministries	Houston, TX	05/14/2021	
One Source International, LLC	Houston, TX	05/14/2021	
One Way Education, LLC	Houston, TX	05/14/2021	
One World Consulting (Kelly Brown)	Cypress, TX	05/14/2021	
Operations Contracting Agency LLC	Schertz, TX	05/14/2021	
Optima Train (Delwar Enterprises LLC)	Houston, TX	05/14/2021	
Optimum Lifestyle CDC (www.olcdconline.org)	Houston, TX		Viewed 05/24/2021
Optimum Nurse Aid Skills Training	Houston, TX		Unsubmitted 05/16/2021
Ozeal Consulting Group (Oziel Enriquez)	Sugar Land, TX	05/14/2021	
Pangea Biological (Okapi Environmental Group, Inc.)	Carlsbad, CA	05/14/2021	
Panorama Education	Boston, MA	05/14/2021	
Parents Alliance, Inc	Houston, TX	05/14/2021	
Parker and Jamison LLC	Irving, TX	05/14/2021	
Passionate Performance (Kim Nugent)	Houston, TX	05/14/2021	

Pat Strong	Houston, TX	05/14/2021		
Patricia Brown	Missouri City, TX	05/14/2021		
Patricia Monticello Kievlan (Patricia Marie Kievlan)	The Woodlands, TX	05/14/2021		
Paula Kluth Consulting	River Forest, IL	05/14/2021		
Payton, Nix & Associates, LLC	LUCAS, TX	05/14/2021		
PCG-UI	Staunton, VA	05/14/2021		
Pcubed (Program Planning Professionals)	Ann Arbor, MI	05/14/2021		
Performance Scoring, LLC.	Lewisville, TX	05/14/2021		
PHD Resources & Taxes	Houston, TX	05/14/2021		
Pinnacle Workforce Strategies	Tucson, AZ	05/14/2021		
Pittman Training (Vision Educational Solutions)	Dallas, TX	05/14/2021		
Plante & Moran, PLLC	Southfield, MI	05/14/2021		
Porter Brown Associates	Alachua, FL	05/14/2021		
Positive Behavior Supports Corp	IRVING, TX	05/14/2021		
Positive Coaching Alliance	Houston, TX	05/14/2021		
PositiveKidsToday (CultureCre8ionLLC)	Montgomery, TX	05/14/2021		
Postlethwaite & Netterville APAC (Lacher)	Baton Rouge, LA	05/14/2021		
Powell-Leon, LLP	Austin, TX	05/14/2021		
Power Institute LLC	Missouri City, TX	05/14/2021		
Power of Choosing Inc.	Texas, TX	05/14/2021		
Presidential Staffing Solutions	San Antonio, TX	05/14/2021		
Price Consulting, Inc.	Houston, TX	05/14/2021		
Principal Kafele Consulting, LLC (Baruti K. Kafele)	Jersey City, NJ	05/14/2021		
Proactive Thought Leaders, LLC	Arlington, TX	05/14/2021		
ProBizAssoc.com (Beth Philley)	Canton, OH	05/14/2021		
Probolsky Research	Newport Beach, CA	05/14/2021		
PROCEDEO	Fort Worth, TX	05/14/2021		
Productive Ventures	Spring, TX	05/14/2021		
Project GRAD Houston	Houston, TX	05/14/2021		
Projects-Matter (Projects-Matter LLC)	Houston, TX	05/14/2021		
Promethean, Inc.	Alpharetta, GA	05/14/2021		
Pronto Shipping and Packaging Services Inc.	Houston, TX	05/14/2021		
Prosperity Project Management LLC (N/A)	Washington, DC	05/14/2021		
ProUnitas Inc.	Houston, TX	05/14/2021		
Public Works LLC	West Chester, PA	05/14/2021		
Purposeful Parents	Webster, TX	05/14/2021		
PVH Consulting Group LLC	Austin, TX	05/14/2021		
Ramos & Harrison	Corpus Christi, TX	05/14/2021		
RC Herrin Consulting	Kyle, TX	05/14/2021		
RDI Global Services	El Paso, TX	05/14/2021		
Recruiting In Motion	Orlando, FL	05/14/2021		
Reflective Energy Solutions	Hackensack, NJ	05/14/2021		
Region One Education Service Center	Edinburg, TX	05/14/2021		
Reliable R&R Training Services	Dallas, TX	05/14/2021		
Relocation Strategies (Luo & Chang Investment LLC)	houston, TX	05/14/2021		
Remember When Kids Were Kids (Jaelijah)	Spring, TX	05/14/2021		
Resolute Educational Solutions, L.L.C.	Detroit, MI	05/14/2021		
Resolute Learning Systems, Inc.	Houston, TX	05/14/2021		
Resources Inspiring Success and Empowering	Houston, TX	05/14/2021		
Restorative Empowerment for Youth	Houston, TX	05/14/2021		
RG Guillory Education & Consulting, LLC	Houston, TX	05/14/2021		
Rhyming to Respect L.L.C.	Largo, MD	05/14/2021		
Rising Star Academy	Houston, TX	05/14/2021		
Rivera-Vega Group, LLC.	San Antonio, TX	05/14/2021	Viewed	05/14/2021
RND Technology	Houston, TX	05/14/2021		
Robert Jackson	Indianapolis, IN	05/14/2021		
Rogers, Morris & Grover, LLP	Houston, TX	05/14/2021		
Roland Gonzales	Spring, TX	05/14/2021		
RR CONNECTION CONSULTING	Duncanville, TX	05/14/2021		
RTI International (Research Triangle Institute)	Research Triangle Park, NC	05/14/2021		
Rukaz Kultura	HOUSTON, TX	05/14/2021		
RYE Consulting	Chicago, IL	05/14/2021		
S Corporation	Phila, PA	05/14/2021		
Sabari Tech Solutions LLC	Richmond, TX	05/14/2021		

Savvas Learning Company LLC	Paramus, NJ	05/14/2021		
SBC Consulting (Tammy Smithers)	Houston, TX	05/14/2021		
SBLM Architects	New York, NY	05/14/2021		
School by Design (Education by Design, LLC)	Waltham, MA	05/14/2021		
Schools Cubed	Arvada, CO	05/14/2021		
Schultz Center for Teaching and Leadership, Inc.	Jacksonville, FL	05/14/2021		
Science Unlimited, LLC	Missouri City, TX	05/14/2021		
Scott Academics	Houston, TX	05/14/2021		
Second Chance Technology Edge High School	Houston, TX	05/14/2021		
Seeds to STEM	Dallas, TX	05/14/2021		
ServiceMaster Recovery Management (Service Environments of Texas, Inc.)	Kingwood, TX	05/14/2021		
Session Tax Consulting & Grant Writing (Session Tax Consulting and grant writing)	HOUSTON, TX	05/14/2021		
Shamelessly Saved Productions	Richmond, TX	05/14/2021		
Shaneka Smith	Houston, TX	05/14/2021		
Sharron Helmke	Dickinson, TX	05/14/2021		
Sierra Consulting, Inc	Itasca, IL	05/14/2021		
SilkWeb Consulting and Development, LLC	Scottsdale, AZ	05/14/2021		
SimiDigi Inc	Garland, TX	05/14/2021		
Sisters Empowering S.I.S.T.A.S., Inc.	Houston, TX	05/14/2021		
Sketch City	Houston, TX	05/14/2021		
Sky Creations (Rachael Bassey)	Midland, TX	05/14/2021		
Sky's the Limit	Houston, TX	05/14/2021		
SL King and Associates	Atlanta, GA	05/14/2021		
Slalom (Slalom LLC)	Houston, TX	05/14/2021		
SLL Services, LLC	Palestine, TX	05/14/2021		
Smart Scholars Foundation	Houston, TX	05/14/2021		
Smarter HR Solutions	Houston, TX	05/14/2021		
SMARTOX	Irving, TX	05/14/2021		
SMRT Solutions (SMRT Consulting LLC)	Washington DC, DC	05/14/2021		
Social Motion, Inc.	Houston, TX	05/14/2021		
Social Studies Success	Spring, TX	05/14/2021		
Softline International USA, Inc	Miami, FL	05/14/2021		
Solel International	Houston, TX	05/14/2021		
Solution Tree Inc	Bloomington, IN	05/14/2021		
South Texas Counseling and Mentoring : Adult Education	Houston, TX	05/14/2021		
SPDF KIDS	Houston, TX	05/14/2021		
Special Evaluations & Consulting of Texas	Dallas, TX	05/14/2021		
SSG-MUSIC	LAS VEGAS, NV	05/14/2021		
Staff Hunt LLC	Houston, TX	05/14/2021		
Standards Solution Holding, LLC	Washington, NJ	05/14/2021		
Stanford Educational Consultants	Missouri City, TX	05/14/2021	Viewed	05/14/2021
Steam Kidstitude (Insight Community Resources Inc)	Houston, TX	05/14/2021		
STEM Urban Perspective (Science, Technology, Engineering with an Urban Perspective)	Humble, TX	05/14/2021		
Sterling Empowerment	HOUSTON, TX	05/14/2021	Unsubmitted	06/02/2021
Sterling Staffing Solutions (Maceo Carter Investments, LLC)	Sugar Land, TX	05/14/2021		
Sterling Therapy & Rehabilitation	SUGAR LAND, TX	05/14/2021		
Stetson & Associates, Inc.	Houston, TX	05/14/2021		
Steve Spangler Inc.	Littleton, CO	05/14/2021		
Stone Oak Solutions, LLC	New Braunfels, TX	05/14/2021		
Storytelling Time (MARY JO HUFF)	NEWBURGH, IN	05/14/2021		
Straight Defined	Copperas Cove, TX	05/14/2021		
Strategic Solutions Group	Needham, MA	05/14/2021		
STRAUS SYSTEMS INC	STAFFORD, TX	05/14/2021		
Students of Strength, Inc.	Cambridge, MA	05/14/2021		
Successful Starters Learning Academy II	Houston, TX	05/14/2021		
Supporting Educators Daily	Missouri City, TX	05/14/2021		
Susan M. Catlett, Ph.D., BCBA-D	Houston, TX	05/14/2021		
SWA International Company	Houston, TX	05/14/2021		
Sylvan Learning, Inc.	Baltimore, MD	05/14/2021		
Table SALT Group	Houston, TX	05/14/2021		
TakshaSmartlabz (Southern California Roc School District)	PLANO, TX	05/14/2021		

Tammy Rodney	Houston, TX	05/14/2021			
TAPS Academy	Houston, TX	05/14/2021			
TCT Enterprises, LLC	Houston, TX	05/14/2021			
TDG Consultants	Houston, TX	05/14/2021			
Teach2Learn (Elliott and McMahon)	Friendswood, TX	05/14/2021			
Teaching Strategies, LLC	Bethesda, MD	05/14/2021			
Teachstone Training, LLC	Charlottesville, VA	05/14/2021			
TeamLogic IT (Philoxenus, Inc.)	Houston, TX	05/14/2021			
TechStudios LLC	Houston, TX	05/14/2021			
Texan-French Alliance for the Arts	Houston, TX	05/14/2021			
Texans Together Education Fund Inc	Houston, TX	05/14/2021			
Texas Art Supply Company	Houston, TX		No Bid	06/07/2021	06/07/2021
Texas Educational Consultative Services, Inc.	Austin, TX	05/14/2021			
Texas Initiative Programs (The K16 Ready Society, Inc.)	Fort Worth, TX	05/14/2021			
Texas State Billing Services Inc	Kyle, TX	05/14/2021			
Texas Tutors	Dallas, TX	05/14/2021			
The Afterschool Professional	Pflugerville, TX	05/14/2021			
The Bob Pike Group	Bloomington, MN	05/14/2021			
The Box Program (Box Program)	Baytown, TX	05/14/2021			
The Carmona Firm, PLLC	Houston, TX	05/14/2021			
The CNA Corporation (CNA)	Arlington, VA	05/14/2021			
The Core Collaborative, Inc	San Diego, CA	05/14/2021			
The Cosmetology Connection & Consulting Services	Houston, TX	05/14/2021			
The Danielson Group	Chicago, IL	05/14/2021			
The E2 Group, Inc.	Sugar Land, TX	05/14/2021			
The Education Partners (GEMS/The Education Partners)	New York, NY	05/14/2021			
The Educator Collaborative	Astoria, NY	05/14/2021			
The Educator's School Safety Network	Genoa, OH	05/14/2021			
The Execu Search Group (Execu Search Holdings, LLC)	New York, NY	05/14/2021			
The Flippen Group	College Station, TX	05/14/2021			
The Gibson Lupus Resource Center	Houston, TX	05/14/2021			
The Hanover Research Council, LLC	Arlington, VA	05/14/2021			
The Harris Foundation	Houston, TX	05/14/2021			
The Healthy School Food Collaborative	New Orleans, LA	05/14/2021			
The K.N.E.W. Solutions (Keschia Matthews)	FRESNO, TX	05/14/2021			
The Kovacs Group	New Braunfels, TX	05/14/2021			
The McMikle Group, LLC	Hartford, CT	05/14/2021			
The National Behavioral Intervention Team Association	King of Prussia, PA	05/14/2021			
The National Literacy Professional Development Consortium	8325 Broadway, Ste. 202, TX	05/14/2021			
The Ombudsmen Group	Cibolo, TX	05/14/2021			
The Outreach Program Education/Counseling Services	Houston, TX	05/14/2021			
The Parent Coach	HOUSTON, TX	05/14/2021	Unsubmitted	05/21/2021	
The Platform	Houston, TX	05/14/2021			
The Process Manager (Meliton Moya, Ph.D.)	Edinburg, TX	05/14/2021			
The Style Signature	Carrollton, TX	05/14/2021			
The TEAMS Group, LLC	Austin, TX	05/14/2021			
The Village Education Solutions	Spring, TX	05/14/2021	Viewed	05/14/2021	
The Yates Company	Houston, TX	05/14/2021			
Theresa Harris	HOUSTON, TX	05/14/2021			
thinkLaw (CS Educational Services, LLC)	Las Vegas, NV	05/14/2021			
Thomas Educational Solutions	Pearland, TX	05/14/2021			
Thompson Educational Consulting, Inc.	Missouri City, TX	05/14/2021			
Tier One Learning, LLC	Sugar Land, TX	05/14/2021			
Timothy Project: Youth Mentoring Youth, Inc.	Houston, TX	05/14/2021			
Tiphany Chambers Burrell	HOUSTON, TX	05/14/2021			
TLE Inc (The Look Enterprises, Inc.)	Bellaire, TX	05/14/2021			
TMI Solutions, LLC	George West, TX	05/14/2021			
TNTP (The New Teacher Project, Inc.)	Brooklyn, NY	05/14/2021			
Total Special Education Solutions, LLC	Beaumont, TX	05/14/2021			
Transaption	Wilmington, DE	05/14/2021			

Transformation7 by Tiffany A. Washington	Houston, TX	05/14/2021			
Translation & Interpretation Network (Catholic Charities Diocese of Fort Worth, Inc. d/b/a Translation & Interpretation Network)	Fort Worth, TX	05/14/2021	Viewed	05/17/2021	
Trenton Kirksey	Houston, TX	05/14/2021			
Trezvant Academy, Inc	Houston, TX	05/14/2021			
Trice Education Resources Inc.	Sugar Land, TX	05/14/2021			
True Love Childcare	Humble, TX	05/14/2021			
TSC COGIC	houston, TX	05/14/2021			
TSG Industries (The Sithe Group, LLC.)	Houston, TX		Viewed	06/04/2021	
Turning a New Page (Turning a New Page Educational Consultants LLC)	Tucson, AZ	05/14/2021			
Tutor Doctor	Navasota, TX	05/14/2021			
Tynker	Mountain View, CA	05/14/2021			
U. S. WHOLESALE PRODUCTS	SAN ANTONIO, TX	05/14/2021			
U.S. Dream Academy, Inc	Columbia, PA	05/14/2021			
U-Bridge Project Consulting, LLC	Sugarland, TX	05/14/2021	Submitted	06/06/2021	06/06/2021
UnboundEd Learning, Inc.	New York, NY	05/14/2021			
Universities Space Research Association	Columbia, MD	05/14/2021			
Unlimited Visions Aftercare, Inc	Houston, TX	05/14/2021			
UNTAPPED Genius	Missouri City, TX	05/14/2021			
UP Educational Consulting	Conroe, TX	05/14/2021			
US Executive LLC	Tampa, FL	05/14/2021			
ValidateME! (VALIDATE ME! LLC)	Brownsville, TX	05/14/2021			
Vanguard Trading & Services, LLC	Houston, TX	05/14/2021			
Velvet Rope Experience (VRE Business Soulutions)	Houston, TX	05/14/2021	Viewed	05/17/2021	
Victory Group	Houston, TX	05/14/2021			
Vida Education (Vida Consulting LLC)	Arlington, TX	05/14/2021			
Vinnove Consulting Group	San Antonio, TX	05/14/2021			
VOX Global	Dallas, TX	05/14/2021			
vRealm Inc.	Sterling, VA	05/14/2021			
VRJ & Associates, LLC	Sugar Land, TX	05/14/2021			
Walden University	Minneapolis, MN	05/14/2021			
WaterLily Writing, LLC	Arlington, TX	05/14/2021			
Watkins & Associates Consulting Services LLC.	Houston, TX	05/14/2021			
Wellspring Family & Community Institute	Houston, TX	05/14/2021			
Wendy Mackey	Halifax,, NS	05/14/2021			
Wendy Perry Coparenting Education (www.wendyjerry.com)	Watauga, TX	05/14/2021			
Westat	San Antonio, TX	05/14/2021			
Williams Education Consulting	Houston, TX	05/14/2021			
Willow Tree Early Education Team	Missouri City, TX	05/14/2021			
Workshop Houston	Houston, TX	05/14/2021			
World Class Rope Skipping	Richmond, TX	05/14/2021			
Wright One Training	Flower Mound, TX	05/14/2021			
Writers in the Schools	Houston, TX	05/14/2021			
Writing with Design (The Learning Project)	Norman, OK	05/14/2021			
WRM Development	Selma, TX	05/14/2021			
Yolah - Yolandra Drake	Houston, TX	05/14/2021			
Your Pro Medical Inc. (Your Pro Consultant Inc.)	Bedford, TX	05/14/2021			
Youth Advocacy TEAM	Houston, TX	05/14/2021			
Youth Debate League (MDG Gulf Coast, LLC)	Missouri City, TX	05/14/2021			
YR Testing Account	Everywhere, TX		Unsubmitted	05/25/2021	
Z Smart, LLC	Rockwall, TX	05/14/2021			
ZNA DESIGN (ZNA GROUP LLC)	Katy, TX	05/14/2021			

## External Invitations

Invite Email	Auto Approve	Invitation Date	Status	Status Date
bmartin53@gmail.com	No	05/14/2021	Invitation Sent	05/14/2021
Deytra@parfavour.com	No	05/14/2021	Approved	06/03/2021
divinefitness9@gmail.com	No	05/14/2021	Invitation Sent	05/14/2021
frank@drfharris3.com	No	05/14/2021	Invitation Sent	05/14/2021
knormington@Lee.Edu	No	05/14/2021	Invitation Sent	05/14/2021
kyle.cavolo@focalpoint.education	No	05/14/2021	Approved	05/19/2021



**Regular Board Meeting**

**8.F.9.**

**Meeting Date:** July 21, 2021  
**Title:** CH Local FY 21 - Revised  
**Submitted For:** Kendra Jackson, Purchasing

**Submitted By:** Kendra Jackson  
**HCDE Goal(s):** 2. Deliver value responsibly

**Recommended Action:** Approve

**Additional Resource Personnel:** Dr. Jesus Amezcua, Kendra Jackson

**Facilities/Technology Approval Needed?:** None

**Information**

**Posted Agenda Item:**

**Approval to amend CH Local 2021 allowable maximum contract amount** for SOA Fin 1st, (job no. 20/019KJ) for a total amount of \$80,000.

**Subject:**

Request an increase in maximum allowable spending under CH Local

**Rationale:**

The CH Local allowed maximum expenditures need to be amended to reflect anticipated spending for SOA Fin1St.

**Fiscal Impact**

**Attachments**

*No file(s) attached.*

**Form Review**

**Inbox**

Purchasing  
Assistant Superintendent - Business  
Form Started By: Kendra Jackson  
Final Approval Date: 06/28/2021

**Reviewed By**

Kendra Jackson  
Jesus Amezcua

**Date**

06/21/2021 02:25 PM  
06/28/2021 02:13 PM  
Started On: 06/21/2021 08:52 AM

**Regular Board Meeting**

**9.A.**

**Meeting Date:** July 21, 2021

**Title:** Adoption FY 2021-2022 Budget which incorporates the 2021-2022 Salary Schedule

**Submitted For:** Jesus Amezcua, Business Office

**Submitted By:** Jaime Martinez

**Recommended Action:** Approve

**HCDE Goal(s):**  
1. Impact education/respond to evolving needs  
2. Deliver value responsibly  
3. Advocate for learners through innovation  
4. Provide cost savings by leveraging tax dollars  
5. Recruit high-quality professionals

**Additional Resource Personnel:**

**Facilities/Technology Approval Needed?:** None

**Information**

**Posted Agenda Item:**

**Consider adoption of the Harris County Department of Education FY 2021-2022 Proposed Annual Budget totaling Out Flows for \$154,234,536; \$62,390,032 for the General Fund, \$48,233,919 for the Special Revenue Fund, \$4,446,773 for the Debt Service Fund, \$26,299,942 for the Capital Projects Fund, \$6,200,490 for the Internal Service Fund, and \$6,663,380 for the Enterprise Fund. The adoption of this budget also incorporates the 2021-2022 proposed salary increases and schedules.**

**Subject:**

Adoption of the Harris County Department of Education FY 2021-2022 Proposed Annual Budget totaling \$154,234,536 which incorporates the 2021-2022 salary schedules.

**Rationale:**

According to CE-Local policy, the budget is required to be adopted prior to August 31, 2020. The tax rate adoption is tentative pending the property value certification.

		Governmental			Proprietary		
		Special	Debt	Capital	Internal		
	General	Revenue	Service	Projects	Service	Enterprise	TOTAL
	Fund	Fund	Fund	Fund	Fund	Fund	
Estimated Revenue	\$59,188,729	\$48,233,919	\$3,810,219	\$1,121,000	\$6,200,490	\$5,563,380	\$124,117,737
Appropriation & Other	\$62,390,032	\$48,233,919	\$4,446,773	\$26,299,942	\$6,200,490	\$6,663,380	\$154,234,536
Balance	\$17,920,191	\$ -	\$1,532,317	\$26,939,650	\$ -	\$400,000	\$48,136,225

The total budget includes 2% salary increase for all staff. Grant funds are also included depending on available grant funds. The Board members that attended the budget hearing on June 15th, 2021 were Danny Norris, Richard Cantu, Andrea Duhon, Eric Dick and via ZOOM David Brown. The Administrative present at the budget hearing were James Colbert, Jr., Dr. Jesus Amezcua, Dr. CJ Rodgers, Jonathan Parker, Natasha Truitt, Rich Vela, Danielle Clark, Danielle Bartz, Stephanie Hardin, Marcia Leiva and Jaime Martinez.

## Fiscal Impact

## Attachments

1.1 Executive Summary  
FY22 Salary Schedule  
FY22 Proposed Budget Table

---

### Form Review

**Inbox**

Assistant Superintendent - Business  
Form Started By: Jaime Martinez  
Final Approval Date: 06/21/2021

**Reviewed By**

Jesus Amezcua

**Date**

06/21/2021 04:00 PM  
Started On: 06/21/2021 07:59 AM

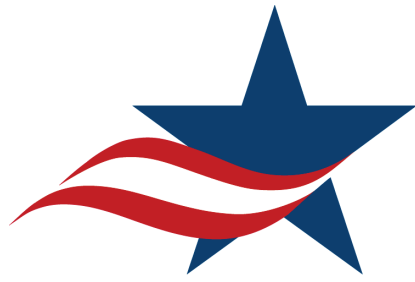

# Harris County Department of Education

June 15<sup>th</sup>, 2021

Members of the Board of Trustees  
Harris County Department of Education

6300 Irvington Boulevard  
Houston, Texas 77022

Dear Trustees:

We are pleased to present the Harris County Department of Education's (the Department or "HCDE") Annual Budget for fiscal year 2021-2022. This budget presents the Department's financial and operations plan.

## Introduction

In accordance with State requirements, we are presenting our projected budget to the Board of Trustees and to the Harris County community. We encourage you and our citizens to engage in positive dialogue in fine tuning our budget proposal. Given the limited resources, our staff has developed a financial plan for the 2021-2022 General Fund, Debt Service Fund, Enterprise Fund, Capital Projects Fund, and Internal Service Fund Budgets. The development, review, and consideration of the 2021-2022 budget were completed with a detailed review of every revenue and expenditure item within the context of the Department's mission, goals, and financial policies. This document provides information on each of the fund budgets. In addition, we also provide information about our projected grants, which are accounted as Special Revenue Funds.

The primary purpose of this document is to provide timely and useful information concerning the past, current, and projected financial status of the Department, to facilitate financial decisions that support the educational goals of the Department. This budget's focus is the improvement of HCDE divisions with the fiscal resources available to the Department. This budget addresses the essential needs of the Department by directing resources to those areas that will assist our staff in carrying out the mission of HCDE.

With this budget, we are continuing to use our performance-based budgeting model. Our conservative process focuses on evaluating programs and initiatives for efficiencies while considering current resources. Moreover, two variables are then reviewed during our SWOT Analysis Review (Strengths, Weaknesses, Opportunities & Threats Analysis), which includes (1) to determine the fee structure for our clients and the (2) level of taxation based on the property values projected to be received from the Harris County Appraisal District.

**James Colbert, Jr.**  
County Superintendent

### Board of Trustees

**Danyahel (Danny) Norris**  
President

**Richard Cantu**  
Vice President

**Andrea Duhon**  
Second Vice President

**David W. Brown**

**Erica Davis**

**Eric Dick**

**Amy Flores Hinojosa**

The HCDE Accountability System has been used as the basis for this performance-based budgeting model. This is the thirteenth year using goals, objectives, and performance measures to plan the budget. This budget document is the first step towards achieving these goals. It includes sound, prudent fiscal policies that will ensure the continuity of the Department.

## **About Harris County Department of Education**

Harris County Department of Education (HCDE), one source for all learners, is a highly successful educational resource in the Houston Metroplex, is a nonprofit tax-assisted organization dedicated to the equalization of educational opportunity and to the advancement of public schools. HCDE has been serving the county's public schools for 132 years.

HCDE is in Harris County in the upper Gulf Coast region of Texas, approximately 50 miles from the Gulf of Mexico. Harris County, Texas with 4.7 million people, is the third most populous county in the United States and houses the fourth largest city in the Country. Harris County's population base includes a wide variety of racial, ethnic, and socio-economic groups that give the area a rich diversity and cosmopolitan feel. In Texas, the second largest county is Dallas with 2.62 million people.

Harris County and the Houston metropolitan area comprise a leading region of business development in the nation. Houston continues to be a leader in oil and gas, aerospace, industrial engineering, and medical research, but diversification is fueling the local economy. The County's major hospitals, many of these concentrated just south of downtown Houston in the Texas Medical Center, offer world-class facilities for general and specialized medical needs. Houston is the fourth largest city in the nation and is a leader in numerous industries including oil & gas, manufacturing, healthcare services and engineering.

There are 25 public school districts located either entirely or partially within Harris County, as well as charter, private, and parochial schools. HCDE impacts the educational community through visionary leadership, shared resources, and innovative programs.

### HCDE Mission Statement

Harris County Department of Education supports Harris County by enriching educational opportunities and providing value through services.

### **Department Goals:**

1. Impact education by responding to the evolving needs of Harris County.
2. Deliver value to Harris County by utilizing resources in an ethical, transparent, and fiscally responsible manner.
3. Advocate for all learners by using innovative methods to maximize students' potential.
4. Provide cost-savings to school districts by leveraging tax dollars.
5. Recruit and maintain high-quality staff.

In the reaching of these goals, HCDE is a public entity dedicated to helping meet the needs of uniquely challenged learners and school staff through innovative programing and support services. HCDE directly serves approximately 135,000 students with four alternative campuses, therapy services provided in local schools, 14 Head Start centers for early childhood education, after-school programming in dozens of community and school settings, the largest Adult education program in Texas, and other programs. HCDE also supports educators and staff through a diversity of programs and operational support, which will be presented in more details in this document.

Each HCDE Division has objectives directly associated with the Department's goals, that are measured annually by the HCDE Accountability System. The Performance Measures are in four constructs:

1. Service Delivery
2. Client Satisfaction
3. Compliance
4. Financial Objectives

## **Budget Process and Significant Changes**

### **Legal Requirements in Preparing the Budget**

The Texas Education Code requires that a local education agency prepare a budget of anticipated expenditures and revenues on or before August 20<sup>th</sup>. The Board is required to adopt a budget before August 31<sup>st</sup>. The budget must be itemized in detail according to classification (object) and purpose of expenditure (function) and be prepared according to General Accepted Accounting Principles.

The budget must be legally adopted before the adoption of the tax rate. The president of the Board of Trustees must call a public meeting of the Board of Trustees giving ten days public notice in a newspaper for the adoption of the budget. Any taxpayer within the Department's taxing authority, may be present and participate in the meeting. The budget must be adopted by the Board of Trustees, inclusive of budget amendments no later than August 31<sup>st</sup>.

### **Budget Development Process**

The budget development process comprises three stages: planning, preparation, and evaluation. The first phase, planning, involves defining the mission, goals, and objectives of campuses, divisions, and the Department. This initial phase took place from September 2020 and lasted until the middle of January 2021.

Once these plans and programs have been established, the preparation phase of budgeting begins by allocating resources to support them. This phase took place the second quarter 2021 with several training sessions. Every division started assigning resources and gathering the data.

Evaluation is the last step of the Department's budget cycle, in which information is compiled and analyzed to assess the performance of each individual division and campus, as well as the Department as a whole. During April and May, the data was analyzed, organized, and summarized in the Board Budget Committee Workbook. After several meetings, evaluations, and adjustments, the Administration prepared a Board Budget Book that was presented to the Board Budget Committee during three hearings that will take place on June 15<sup>th</sup>, and July 14<sup>th</sup>, 2021.

The Human Resources Department played an important role assisting the Business Support Services in the budget process as they developed salary budgets utilizing established staffing guidelines. On July 21<sup>th</sup>, the Board of Trustees will be presented with a final proposal for adoption and to be implemented on September 1<sup>st</sup>, 2021.

### **Amending the Budget**

A budget is an estimate of planned expenditures and expected revenues. Many changes can take place between estimating for the proposed budget in March and April and the start of the new fiscal year in September. Program and operational changes will mean budget changes. These changes to the budget are made in the form of budget amendments. Any increase or decrease in the budget expenditures requires board approval. Changes to revenues also require budget adjustments before the end of the year. All other changes are submitted by divisions and campuses to the Business Support Services for review and processing.

### **COVID19 Impact**

On March 9, 2020, the Department was scheduled to go on Spring Break, and it was preparing to develop the budget projections for the next year, and the news of a widespread pandemic hit the Nation. The President of the United States declared an Emergency Disaster situation across the US, and in Texas, the Governor implemented a stay home mandate for the state. The Department staff did not return from the spring break, and everyone was asked to go on emergency leave pending guidance from the federal, state, and local authorities. Soon thereafter, the staff was asked to work from home and be available for

meetings via TEAMS, ZOOM and other communication means. Work from support divisions continued from home, and service division began to provide alternative services to districts and students via ZOOM and distance learning. HCDE staff returned to work from the office in July 2<sup>nd</sup>, 2021. Operations continued as normal on the General Fund activities and all Special Revenue grants administered by HCDE. Keeping all the restriction in distancing, wearing masks and all other preventive measures, the Department went through the budget review process by holding meetings with Division Directors in a socially distanced conference room. Clients have been in close contact with our Divisions, and all indications are that contracts are projected to be renewed at higher levels of services. To address the potential loss of revenues this year and next year, the Department is looking at developing new plans and projections to include utilizing the revenue and tax projections to meet budget needs for the new year.

## **Initiatives for FY 21-22**

In meeting the goals and objectives of the Board of Trustees, the Superintendent has implemented several new initiatives that will enhance the relations with school districts while maintaining a positive business model. Fiscal results and projections include this new planned objective, and the major initiatives include a focus of six major enhancements to program and services to include:

1. Maintaining a positive business model while delivering high quality services.
2. Enhancing HCDE's Special Schools by investing in talent and recruitment.
3. Invest in talent and recruitment and establish a \$15 minimum rate per hour.
4. Invest in enhancing marketing strategies and the campaign awareness.
5. Developing major capital projects to continue to serve HCDE clients.
6. Continuing our competitive edge to enhance services to school districts.

To this objective, our financial plan encompasses the major elements: (1) the enhancement of local revenues through projected contract commitments that will be presented to the Board during the summer, (2) a review and implementation of program-based budgeting to seek internal efficiencies and budget reductions, (3) the recommendation of competitive salaries and (4) tax revenues due to the adoption of a rate of \$.004993 per \$100 valuation.

Included in the budget are 7.5 new positions aimed at enhancing our capabilities to meet the client needs and enhance our fee revenue stream for Therapy Services, Adult Education, and Head Start Program.

In specific, our operations plan includes the following program enhancements:

1. Wage increase: 2% for all employees. HCDE plans to recruit, hire, and retain high quality staff to be able to provide the best services available in the marketplace.
2. HCDE implemented a wellness program aimed at improving the health of HCDE staff. This program is nutrition-based program designed to promote healthy habits. The projected costs for FY22 is \$35,000.
3. School Based Therapy Program will receive additional 1.5 FTE to increase the level of service to School Districts around the County. The cost is \$133,254.
4. Two grant funded positions for instructional coaching for the Head Start program were recommended. The cost associated is \$138,602.
5. Adult Education will grow in operations and it will require the hiring of 4 FTEs. The cost of the position will be funded by the Adult Ed Grant. The cost is \$248,499.
6. HCDE will continue the marketing strategy and awareness campaign as started the previous year. It will include \$1 Million in the Budget.
7. The Department has also included an appropriation for the lobbying cost commitment previously approved by the Board of Trustees. The cost is \$276,000.
8. Balanced Budget: The proposed budget is balanced for on-going operations, and it is projected that the Department will invest part of its fund balance to implement a capital improvement program. All expenditures will be covered with the revenues generated during the year except for the one-time costs. For more detail see section number 7 below, and in the Capital Expenditure section.
9. A Capital Improvement Plan Phase One is proposed to be implemented. The following projects are proposed:

- a. Administration and Conference Center HVAC replacement for \$477,000.
  - b. Conference Center change in partitions for \$264,000, and
  - c. Replacement of Computers and IT Equipment for \$380,000.
10. A Star Re-Imagined Initiative was aimed at implementing pilot programs that will enhance the footprint of HCDE by rethinking the way we do things. For FY22 \$320,087 will be used across 10 divisions and 15 requests.
11. Planned one-time expenditures from the General Fund balance totaling \$3,201,303 as follows:
- |   |                    |
|---|--------------------|
| Debt Service Transfer for future payments- CIP Plan   | \$610,216          |
| Capital Improvement Plan - Buildings                  | 741,000            |
| Capital Improvement Plan - Equipment                  | 380,000            |
| Star Re-Imagined Program                              | 320,087            |
| Head Start Transfer                                   | 600,000            |
| Education Foundation                                  | 400,000            |
| Retirement benefit                                    | 150,000            |
| Total fund balance capital expenditure appropriations | <u>\$3,201,303</u> |
12. The budget is predicated on adopting a tax rate that will bring in more revenue to address revenue loss and implementation of new initiatives such as the campaign awareness and costs associated with talent recruitment and compensation plan starting at \$15 per hour. The estimated tax rate of \$.0049930 is proposed, and this is the same rate used last year and is expected to be below the voter-approval tax rate ("VAR"). Public hearings and notices will be required to adopt the tax rate. This rate is key to the funding of the operations plan for the current year.

### Summary of Proposed Budgets

The Department utilizes Governmental, Proprietary, and Fiduciary fund types. The Department's Governmental fund types are comprised of General Funds, Special Revenue Funds, Debt Service Funds, and Capital Projects Funds. The Proprietary Fund types include the Internal Service Fund and the Enterprise Fund. The Enterprise Fund includes the Choice Partners. The Fiduciary fund types include Agency Funds. It is important to note that the Department approves the annual budgets for the General Fund, Internal Service Fund, Debt Service Fund and Capital Project Funds. Agency (Custodial) Funds and Special Revenue Funds adopt project-length budgets which do not correspond to the Department's fiscal year end. As the notice of grant awards are received, these are presented for Board approval.



**HCDE fiscal year is September 1<sup>st</sup> to August 31<sup>st</sup>.**

The following table presents a comparison of the proposed expenditures for General Fund with a comparison to fiscal year 2020-2021.

	Adopted Budget 2020-2021	Amended Budget 2020-2021	Proposed Budget 2021-2022	Percent Change
<b>Beg. Fund Balance</b>	<b>\$ 32,835,461</b>	\$ 32,835,461	\$ 21,121,494	
Estimated Revenues (In flows)	57,484,758	57,623,191	59,188,729	3%
Appropriations (Out flows)	55,214,929	55,478,565	56,940,944	3%
Transfers Out	13,858,593	13,858,593	5,449,088	-61%
<b>Total Appropriations (Out Flows)</b>	<b>\$ 69,073,522</b>	<b>\$ 69,337,158</b>	<b>\$ 62,390,032</b>	<b>-10.02%</b>
Excess/(Deficiency) of Revenues				
Over/(Under) Appropriations	(11,588,764)	(11,713,967)	(3,201,303)	
<b>Ending Fund Balance</b>	<b>21,246,697</b>	<b>21,121,494</b>	<b>17,920,191</b>	
<b>Fund Balance categories per GASB 54</b>				
Non-Spendable Fund Balance	177,243	177,243	177,243	
Restricted Fund Balance	-	-	-	
Committed Fund Balance	2,014,976	2,014,976	2,014,976	
Assigned Fund Balance	1,939,384	1,939,384	5,499,088	
Unassigned Fund Balance	17,115,094	16,989,891	10,228,884	
<b>Ending Fund Balance</b>	<b>\$ 21,246,697</b>	<b>\$ 21,121,494</b>	<b>\$ 17,920,191</b>	

Note: The projected fund balance is based on levels spent at 100%. Actual amounts are projected on the next page.

(\*) For FY22, planned one-time expenditures from the General Fund balance \$3,201,303 as follows:

Debt Service Transfer for future payments- CIP Plan	\$610,216
Capital Improvement Plan - Buildings	741,000
Capital Improvement Plan - Equipment	380,000
Star Re-Imagined Program	320,087
Head Start Transfer	600,000
Education Foundation	400,000
Retirement benefit	150,000
<b>Total fund balance capital expenditure appropriations</b>	<b><u>\$3,201,303</u></b>

The following table presents a comparison of the estimated revenues, appropriations, other financing sources and uses, and beginning and ending fund balance of all governmental funds for fiscal year 2021-2022:

	Governmental				Proprietary		Total
	General Fund	Special Revenue Fund	Debt Service Fund	Capital Projects Fund	Internal Service Fund	Enterprise Fund	
<b>Estimated Revenues (In flows)</b>	\$ 59,188,729	\$ 48,233,919	\$ 3,810,219	\$ 1,121,000	\$ 6,200,490	\$ 5,563,380	\$ 124,117,737
<b>Appropriations (Out flows)</b>	56,940,944	48,233,919	4,446,773	26,299,942	6,200,490	2,608,968	144,731,036
<b>Transfers Out</b>	5,449,088	-	-	-	-	4,054,412	9,503,500
<b>Total Appropriations and Other Uses (Out flows)</b>	62,390,032	48,233,919	4,446,773	26,299,942	6,200,490	6,663,380	154,234,536
<b>Appropriations (Out flows) from Fund Balance:</b>	(3,201,303)	-	(636,554)	(25,178,942)	-	(1,100,000)	(30,116,799)
<b>Projected Fund Balance Beg.</b>	21,121,494	-	2,168,871	52,118,592	1,344,067	1,500,000	78,253,024
<b>Projected Fund Balance End.</b>	\$ 17,920,191	\$ -	\$ 1,532,317	\$ 26,939,650	\$ 1,344,067	\$ 400,000	\$ 48,136,225

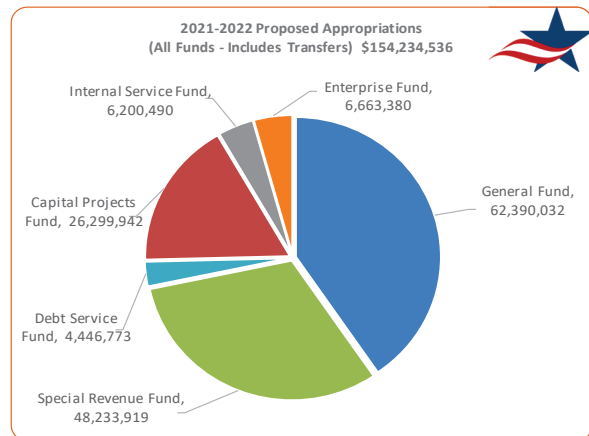
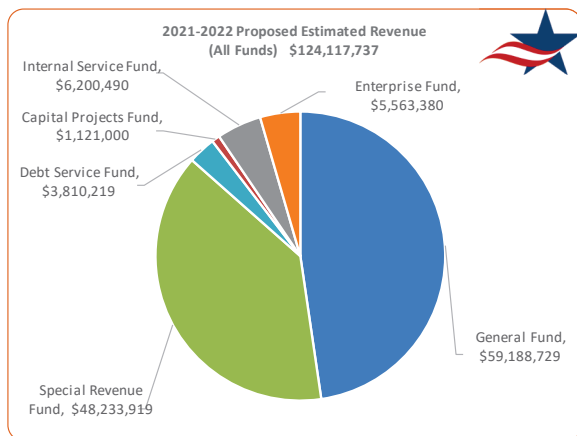

The Department's Proprietary Funds are the Internal Service Fund and the Enterprise Fund. The Internal Service Fund consists of two funds: The Worker's Compensation Fund and the Facilities Support Charges. For the Worker's Compensation Fund, the Department participated in a partially self-funded pool, originally approved by the Board in the fiscal year 2005. Since 2016-2017, the Department moved to a fully funded program. Claims administration, loss control, and consultant services will be provided for worker's compensation insurance company and a third-party administrator will handle the run-off claims from the previous self-insurance plan.

### Internal Service Fund - Workers Compensation

The following table presents a comparison of the proposed fiscal year 2021-2022 revenues and expenditures for the Workers Compensation Fund with a comparison to fiscal year 2020-2021:

	Adopted Budget 2020-2021	Amended Budget 2020-2021	Proposed Budget 2021-2022
<b>Operating Revenues</b>	\$ 450,000	\$ 450,000	\$ 400,000
<b>Operating Expenses</b>	450,000	450,000	400,000
<b>Total Operating Expenses and Other Uses</b>	450,000	450,000	400,000
<b>Net Position</b>	-	-	-
<b>Projected Balance Beginning</b>	1,358,477	1,358,477	1,358,477
<b>Projected Balance Ending</b>	\$ 1,358,477	\$ 1,358,477	\$ 1,358,477

### Internal Service Fund - Facilities Support Charges

The Internal Service Fund also includes the Facilities Support Charges Fund. It consists of facilities support charges that are divided among the divisions based on square footage. The following table presents a comparison of the proposed fiscal year 2021-2022 revenues and expenditures for the Facilities Support Charges with a comparison to fiscal year 2020-2021. The Facilities Division is projecting \$146,500 more than adopted fiscal year 2020-2021 budget due to increase in security expenses.

	Adopted Budget 2020-2021	Amended Budget 2020-2021	Proposed Budget 2021-2022
<b>Operating Revenues</b>	\$ 5,653,990	\$ 5,806,832	\$ 5,800,490
<b>Operating Expenses</b>	5,653,990	5,806,832	5,800,490
<b>Total Operating Expenses and Other Uses</b>	5,653,990	5,806,832	5,800,490
<b>Projected Balance Beginning</b>	-	-	-
<b>Projected Balance Ending</b>	\$ -	\$ -	\$ -

(\* ) Amended Budget fiscal year 2020-2021 adjusted for additional \$14,410 Projected Revenue.

## Enterprise Fund – Choice Partners

The Enterprise Fund consist of the Choice Partners Fund which offers quality, legal, procurement and contract solutions to meet the purchasing needs of school districts and other governmental entities. The following table presents a comparison of the proposed fiscal year 2021-2022 revenues and expenditures for Choice Partners Fund with a comparison to fiscal year 2020-2021.

	Adopted Budget 2020-2021	Amended Budget 2020-2021	Proposed Budget 2021-2022
<b>Operating Revenues (*)</b>	\$ 5,728,380	\$ 5,728,380	\$ 5,563,380
<b>Operating Expenses</b>	2,801,140	2,801,140	2,608,968
<b>Transfers Out</b>	2,927,240	2,927,240	4,054,412
<b>Total Operating Expenses and Other Uses</b>	5,728,380	5,728,380	6,663,380
<b>Projected Balance Beginning</b>	1,500,000	1,500,000	1,500,000
<b>Projected Balance Ending</b>	\$ 1,500,000	\$ 1,500,000	\$ 400,000

(\*) Adopted and Amended Budget fiscal year 2020-2021 adjusted for additional \$500,000 Projected Revenue.

## Balanced Budget

Per CE Local Policy, the operating budget requires a balanced budget. This means that for each fund, expenditures are not to exceed revenues plus projected one-time use fund balances. If the fund balance is used, this cost must be a one-time cost and not recurring (i.e., capital expenditures). The Department is projecting a balanced budget for fiscal year 2021-2022. Expenditures plus other financing uses total \$62,390,032. Revenues equal \$59,188,729. One-time costs total \$3,201,303, from which technology equipment totals \$380,000, Education Foundation program for \$400,000, construction projects total \$741,000, debt service payment from General Fund for \$610,216, Head Start transfer for \$600,000, Star Re-Imagined Campaign for \$320,087, and retirement benefits from Fund Balance for \$150,000. We believe that the budget represents a fiscally responsible and conservative approach to the needs of the Department within the available funds. The chart below shows a historical summary and forecast of the General Fund.

## General Operating Fund Summary (Trend)

	2016-2017 Actual	2017-2018 Actual	2018-2019 Actual	2019-2020 Actual	2020-2021 Amended	2021-2022 Proposed	2022-2023 Forecast	2023-2024 Forecast	2024-2025 Forecast	2025-2026 Forecast	2026-2027 Forecast
<b>Beginning Fund Balance</b>	\$30,920,246	\$28,122,494	\$29,412,173	\$32,614,360	\$32,835,461	\$21,121,494	\$17,920,191	\$16,234,785	\$15,448,293	\$15,340,120	\$15,941,916
<b>Estimated Revenue</b>	49,028,062	51,262,202	56,240,706	54,663,765	57,623,191	59,188,729	59,921,904	61,719,561	63,571,148	65,478,282	67,343,792
<b>Appropriations</b>	43,146,296	44,202,144	47,209,422	48,169,777	55,478,565	56,940,944	57,506,523	58,656,653	59,829,786	61,026,382	62,246,910
<b>Total Other Uses</b>	(8,679,518)	(5,770,379)	(5,829,098)	(6,272,887)	(13,858,593)	(5,449,088)	(4,100,787)	(3,849,399)	(3,849,535)	(3,850,103)	(3,849,687)
<b>Net Change in Fund Balance</b>	(2,797,752)	1,289,679	3,202,186	221,101	(11,713,967)	(3,201,303)	(1,685,406)	(786,492)	(108,174)	601,797	1,247,195
<b>Ending Fund Balance</b>	\$28,122,494	\$29,412,173	\$32,614,360	\$32,835,461	\$21,121,494	\$17,920,191	\$16,234,785	\$15,448,293	\$15,340,120	\$15,941,916	\$17,189,111

For fiscal year 2023 to 2027 forecasted figures the trend includes 3% growth increase in Revenues and 2% at expenditures. A more detailed projection can be found at the Financial Section.

## Projected Fund Balance

We are projecting that the fiscal year 2021-2022 ending fund balance will be \$17,920,191. This represents a decrease of \$3,201,303 from the projected 2020-2021 ending fund balance. The use of fund balance is for planned appropriations that are one time in nature (i.e., construction projects and capital outlay). It is the policy of the Department to maintain an unassigned fund balance equivalent to a minimum of two months of operations costs. Currently, the Department projects the desired fund balance. According to our five-year forecast, the Department will have sufficient funds to meet the CE local policy requirements but may need additional cash to fund the Special Revenue Fund since they work on a reimbursement basis.

## About the 2021-2022 Department Budget

Below are highlights of the Department that will provide you with a general overview of the basis of our assumptions and projections for the coming 2021-2022 fiscal year. To prepare the annual budget, HCDE develops projections for taxable value, collection rate, and expenditure levels.

## Appropriation Levels

**General Operating Fund** –The 2021-2022 appropriation levels for the General Operating Fund are projected at \$56,940,944 and estimated other uses (transfers to other funds and one-time cost at \$5,449,088, for a total of \$62,390,032; this represents a decrease of 10% or \$6,947,126 from 2020-2021 amended budget.

The 2021-2022 budget includes a 2% salary increase for all employees. The budget process was representative of the economic environment. A series of budget meetings and reviews were conducted by the Superintendent and the Budget Committee to achieve this budget. Transfers-out to other funds amounted to \$5,449,088 for fiscal year 2021-2022 mainly due to the additional participation of the General Fund in the construction projects to upgrade existing facilities, Star Re-Imagine project, and debt service contributions from General Fund for the new bonds.

## Comparison of General Operating Fund Appropriations by Object

### General Fund Only -

Object Code	Adopted Budget 2020-2021	Amended Budget 2020-2021	Proposed Budget 2021-2022	Percent Change
Payroll	\$ 39,036,777	\$ 39,016,777	\$ 40,760,751	4%
Contracted Services	5,085,572	5,230,874	5,200,800	-1%
Supplies & Materials	2,779,374	2,790,481	2,761,188	-1%
Misc Operating Cost	8,101,274	8,226,941	8,178,205	-1%
Capital Outlay	211,932	213,492	40,000	-81%
Transfers Out	13,858,593	13,858,593	5,449,088	-61%
<b>Total Appropriations</b>	<b>\$ 69,073,522</b>	<b>\$ 69,337,158</b>	<b>\$ 62,390,032</b>	<b>-10%</b>

In the following charts, please find the comparison of the appropriation for the previous year budget and the current year budget.

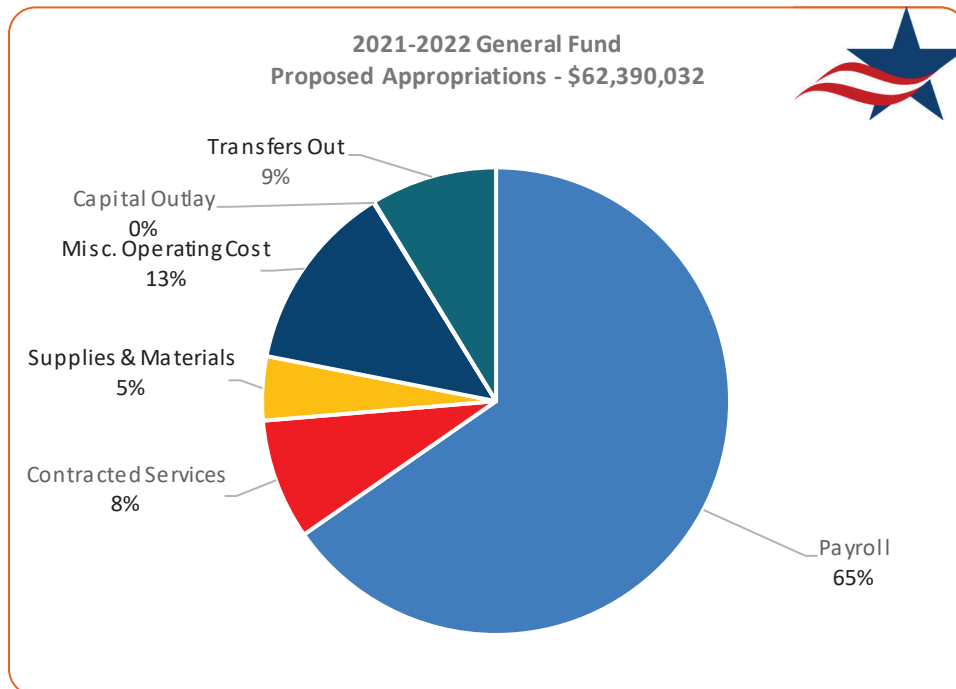
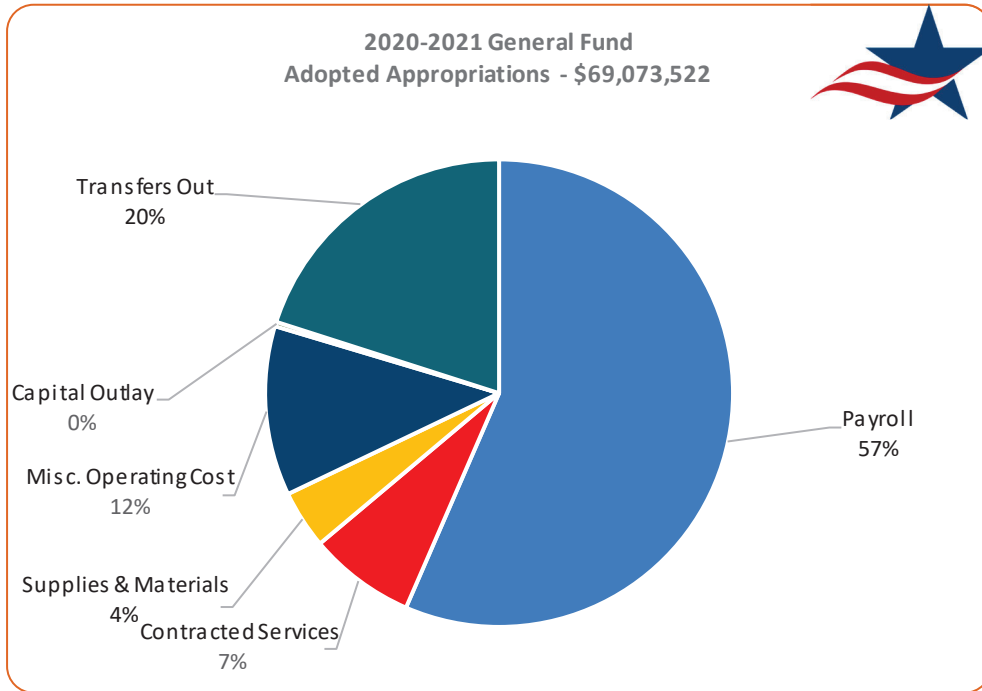

**Debt Service Fund** – The Department budgeted \$4,446,773 in appropriations for fiscal year 2021-2022. Resources in the Debt Service Fund must be used to pay for general long-term debt principal and interest for debt issues and other long-term debts for which revenues are dedicated from the General Fund. A transfer is projected from the General Fund to the Debt Service Fund in the amount of \$2,857,214. Also, there will be a revenue addition for the contribution of the balances remaining in Bank of Texas accounts to debt service for \$953,005. Currently the Department has approximately \$52 million in debt including:

- PFC Lease Revenue bonds for \$27 million issued for the construction of the 2020 Capital improvement Plan that included new buildings for HP East, AB East, Adult Education Center. For these projects, the General Fund contributed \$5.7 million.
- Series 2020 HCDE Maintenance Notes for \$13.8 million for the renovation of the Ronald Reagan building, equipment of the Adult Ed Center, equipment and other resources for AB East, Highpoint East buildings, and other equipment and renovation costs.
- Previous PFC Lease bonds and QZAB bonds for a remaining value of \$11 million

**Special Revenues Funds** – Appropriations for these funds are restricted to or designated for specific purposes by a grantor. For fiscal year 2021-2022, the Department’s appropriation is \$48,233,919. The Department provides information to the Board of Trustees on all Department grants, as the Notice of Grant Awards (NOGA) are received, the estimated revenues and appropriations are adjusted to reflect the awarded grant budget. These grants have restrictions placed by grantors.

**Revenue Levels**

Revenue estimates are based upon a variety of demographic and tax information. Proposed revenue from the two major sources, customer fees and local property taxes, are critical to the budget.

The following charts present the adopted revenue levels for fiscal year 2020-2021 and the proposed revenues for fiscal year 2021-2022.

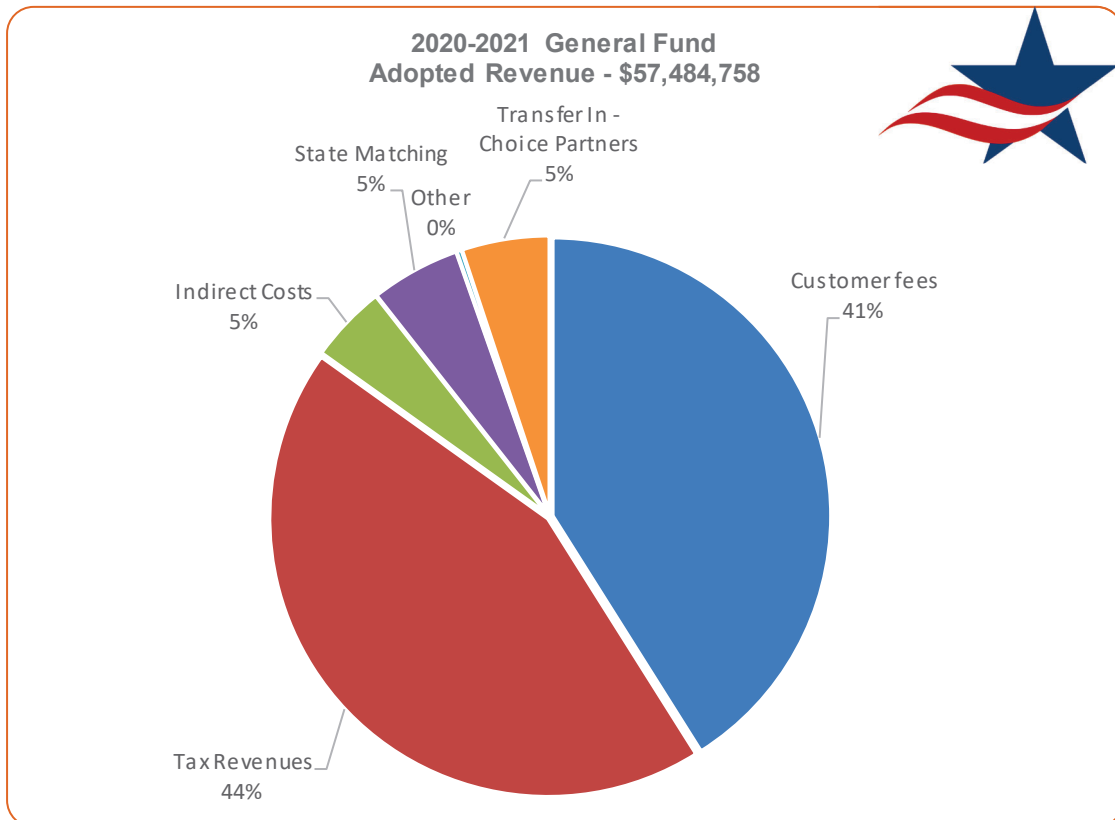

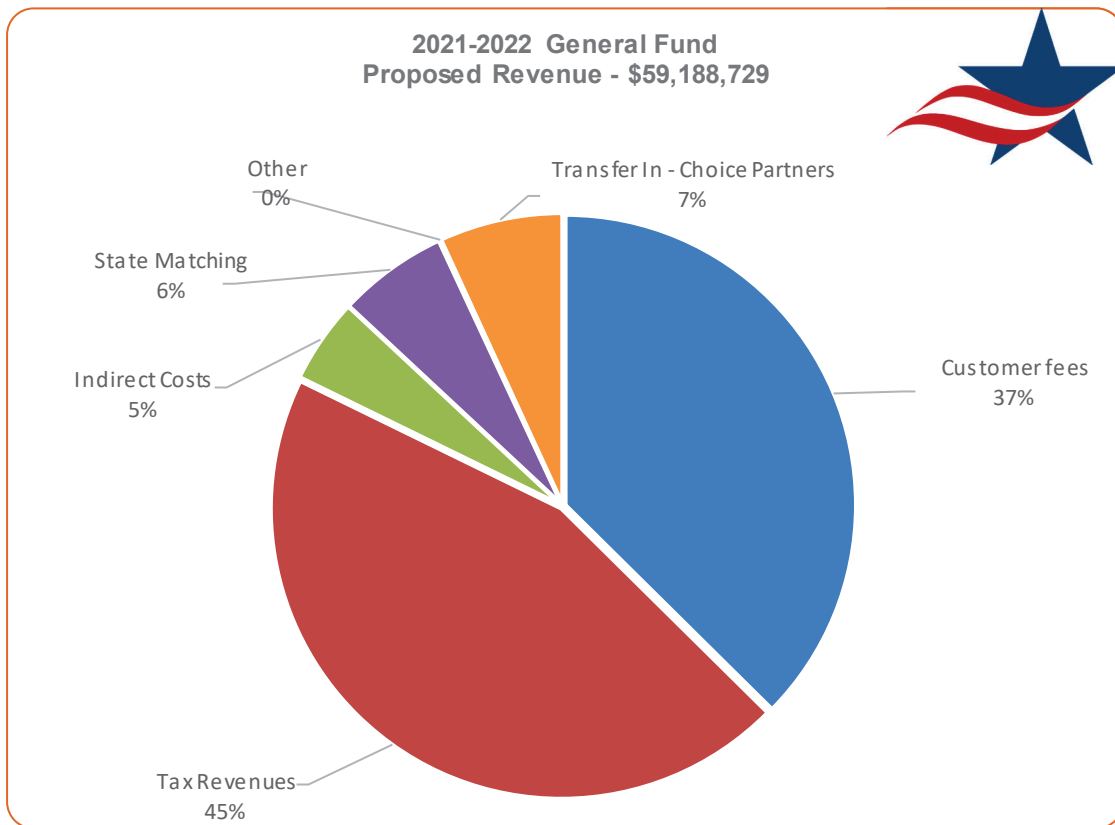

The Department estimates total General Operating Fund revenues of \$59,188,729 for the 2021-2022 fiscal year. Customer fees are projected to be \$22,145,627 or 37% of the estimated revenues. Tax revenues are projected to be \$26,528,250 or 45% of the estimated revenues. The remaining 18% of the revenues are indirect costs at \$2,790,440; state funding \$3,620,000, transfer in from Choice Partners Fund of \$4,054,412 and other revenues at \$50,000.

The recommended budget includes an increase in revenues of 3% from the amended fiscal year 2020-2021 budget for the General Fund.

Object Code	Adopted Budget 2020-2021	Amended Budget 2020-2021	Proposed Budget 2021-2022	Percent Change
Customer Fees	\$ 23,601,005	\$ 23,601,006	\$ 22,145,627	-6.2%
Tax revenues	25,188,000	25,326,432	26,528,250	5%
Indirect costs	2,598,513	2,598,513	2,790,440	7%
State funding	3,000,000	3,000,000	3,620,000	21%
Other	170,000	170,000	50,000	-71%
Transfer In-Choice Partners	2,927,240	2,927,240	4,054,412	39%
<b>Total Revenues</b>	<b>\$ 57,484,758</b>	<b>\$ 57,623,191</b>	<b>\$ 59,188,729</b>	<b>3%</b>



## Local Revenues

Local revenues are projected to increase by 1%. Revenues from current year customer fees are expected to decrease by 6.2% from an amended budget of \$23,601,006 in fiscal year 2020-2021 to a projected \$22,145,627 for fiscal year 2021-2022. HCDE has not increased the rates and additional contracted seats at the special schools, no increment in the service rates from Records Management, Therapy division, and the Center for Safe and Secure Schools, and a reduction in rates from Educator Certification and Advancement Division for fiscal year 2021-2022. In addition, the Department anticipates a 5% increase change in tax revenues from \$25,326,432 in fiscal year 2020-2021 to \$26,528,250 in fiscal year 2021-2022 due to the increase in property values and the adopted tax rate. A 3.8% increase in values is projected based on the preliminary estimate from the Harris County Appraisal District. Also, a 99% collection was used in projecting revenues for fiscal year 2021-2022, and it is expected that this rate will be realized for the fiscal year.

**Tax Rate** – Effective January 1<sup>st</sup>, 2020, the State Legislature approved SB3 that included change in terminology for tax rates and tax rate calculations. The new terminology is as follows: Effective Tax Rate – Now called “No-New-Revenue Tax Rate”. Roll Back Tax Rate – Now called “Voter Approval Tax Rate”. In addition, the calculation was changed as the new law requires to use the average of three-year collection rates.

Based on the taxable value, the Department must project the level of taxation that will generate adequate funds to provide for funds to meet Department obligations while keeping in mind the ability of local taxpayers to pay their taxes. The Harris County Tax Office will calculate the no-new-revenue tax rate (“NNRR”), formerly called the effective tax rate. The NNRR was projected at \$.004955 for fiscal year 2020-2021. We expect the proposed tax rate will be below the voter approved rate (VAR) for fiscal year 2021-2022.

Throughout the budget process, we used the current tax rate and the projected values to estimate the level of local effort. Upon receiving the certified values and the NNRR calculation from the Harris County Tax Assessor – Collector, the tax rate proposal will be developed and presented to the board in accordance with the truth in taxation law. Current revenue projections and tax rates are based on projected values and current rates. Projections will be recalculated in accordance with State tax regulations.

**Taxable Value** – The Harris County Appraisal District certifies the taxable value from which the Department begins to develop the estimates for local tax revenues. The 2019 certified valuations of net taxable value for the 2020-2021 fiscal year are \$505,450,987,981 (based on HCAD report updated 4/30/20). The 2021 Preliminary Estimate is \$513,616,649,590 (based on HCAD letter dated 4/30/21), which is an increase of \$8,165,661,609 or 1.61%. For fiscal year 2021-2022 the appraised values were estimated at \$525 billion considering a larger increase of new property added, which represents a 3.81% increase. The adjacent chart illustrates the 10-year taxable value history of the Department. For fiscal year 2021-2022 to 2024-2025, the Department projects a 3% growth on appraised values due to the positive economic impact in the region and value growth.

**Tax Collections** – The collections percentage used to estimate the tax revenues is 99%; the Department’s tax collections goal is 99%. This is a realistic approach given the trend of the Department’s collections effort and the projected tax increase.

## HCDE Property Values and Tax Rates

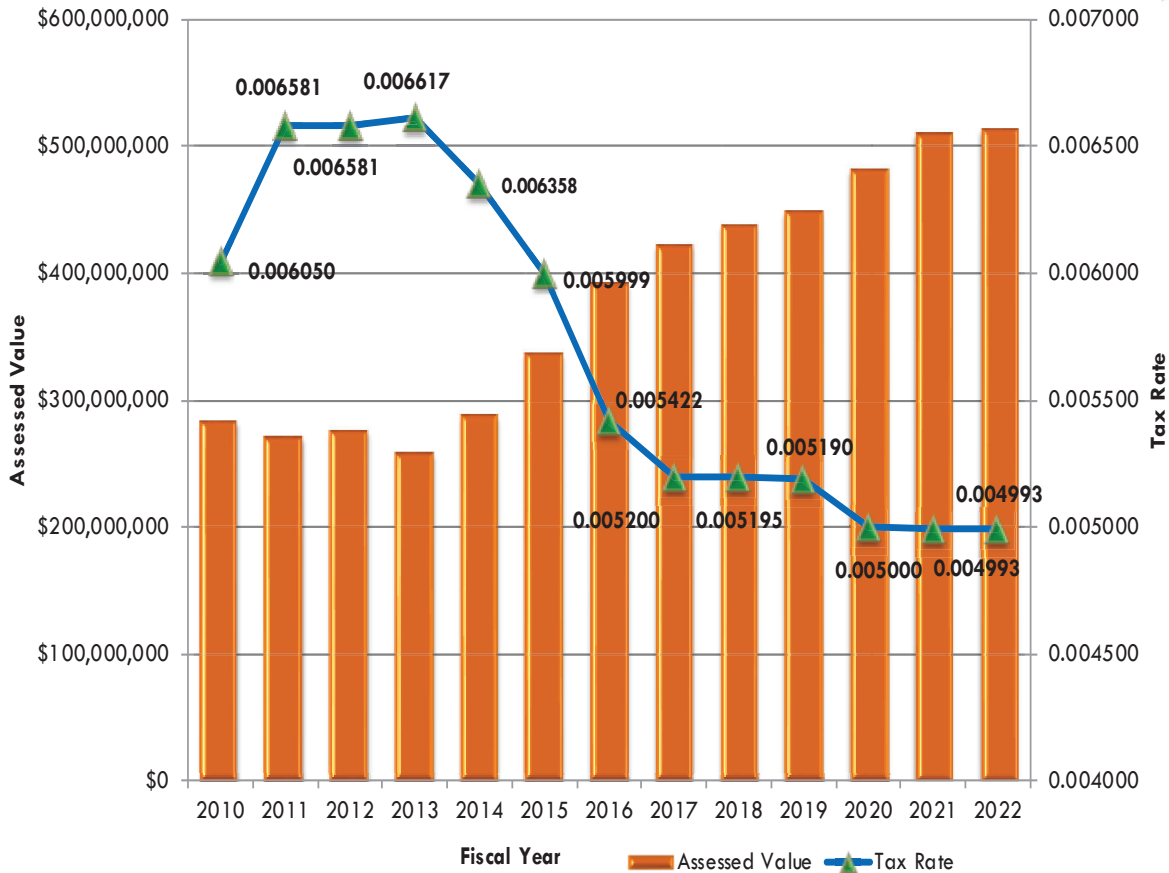

In the chart above, the tax rate has been reducing as the property values for the Harris County have increased. As the population in the Harris County has grown, new areas have been developed with new construction and new businesses.

### Other Tax Revenues

The Department does not have any other local taxes or collections. Harris County Department of Education does not receive sales tax, franchise taxes or any other taxes. It does charge fees for services for various activities. The following are general fee charges by the various divisions.

### Fees for services

**School based therapy services** are provided to school districts which contract with HCDE to provide occupational therapists. The rates based are based whether the district is within the county boundaries or outside of the boundaries. The fees range from \$380 to \$532 per day. The sustainability of this model has been identified as locally supported activity which is assisted by property taxes. There was no increase in fees compared to last year's fees.

**Special school services** are provided to school district which contract with HCDE to provide services for students with behavioral and disability issues. The rates are based whether the district is within the county boundaries or outside of the boundaries. The fees range from \$6,250 (Fortis – In County) to \$23,853 (AB Schools – Out of County) per year. The sustainability of this model has been identified as locally supported activity which is assisted by property taxes. There was no increase in fees compared to last year's fees.

**Records management services** are provided to school districts which contract with HCDE to provide services to safe keeping documents and records. Rates are based whether the district is within the county boundaries or outside of the boundaries. The fees range from \$.24 to .26 cents per box, \$.25 cents per month for tape or film. Rates are lower for educational entities, and other out of County or non-educational entities require a 15% to 25% margin to reduce the cost of providing services to ISDs. There was no increase in fees compared to last year's fees.

**Teaching and Learning Center services** are provided to school districts which contract with HCDE to provide digital training and course development. The rates are based whether the district is within the county boundaries or outside of the boundaries. The fees range from \$850 to \$2,497 depending on the scope of work. The sustainability of this model has been identified as locally supported activity which is assisted by property taxes. There was no increase in fees compared to last year's fees.

**Safe and Secure School services** are provided to school districts which contract with HCDE to provide facility audits. The rates are based whether the district is within the county boundaries or outside of the boundaries. The fees range from \$1,200 to \$2,500 per school. There was no increase in fees compared to last year's fees.

**Certification and Training Services** are provided to individuals seeking certification in the areas of teaching, principalship and superintendency. The rates for the previous fiscal year ranged from \$4,400 to \$6,595 per individual per program, for FY22 the proposed rates will range between \$2,650 to \$3,000 per individual per program. There was a decrease in fees compared to last year's fees.

### **Enterprise Activity**

**Cooperative procurement services** are provided to school districts which contract with HCDE and participate in the national cooperative – Choice Partners. The rates are paid by the vendors based on the type of commodity. The fees range from 1% to 4%. The sustainability of this model has been identified a self-sustaining activity which provides revenue to the General Fund and supports Department activities for grants and other services.

### **Other Local Revenue Sources**

The Department has other sources of revenue. For Fiscal Year 2021-2022 the only source of other revenue is interest. Interest revenues are estimated in \$50,000.

The following chart presents the tax revenues collected in the last ten years.

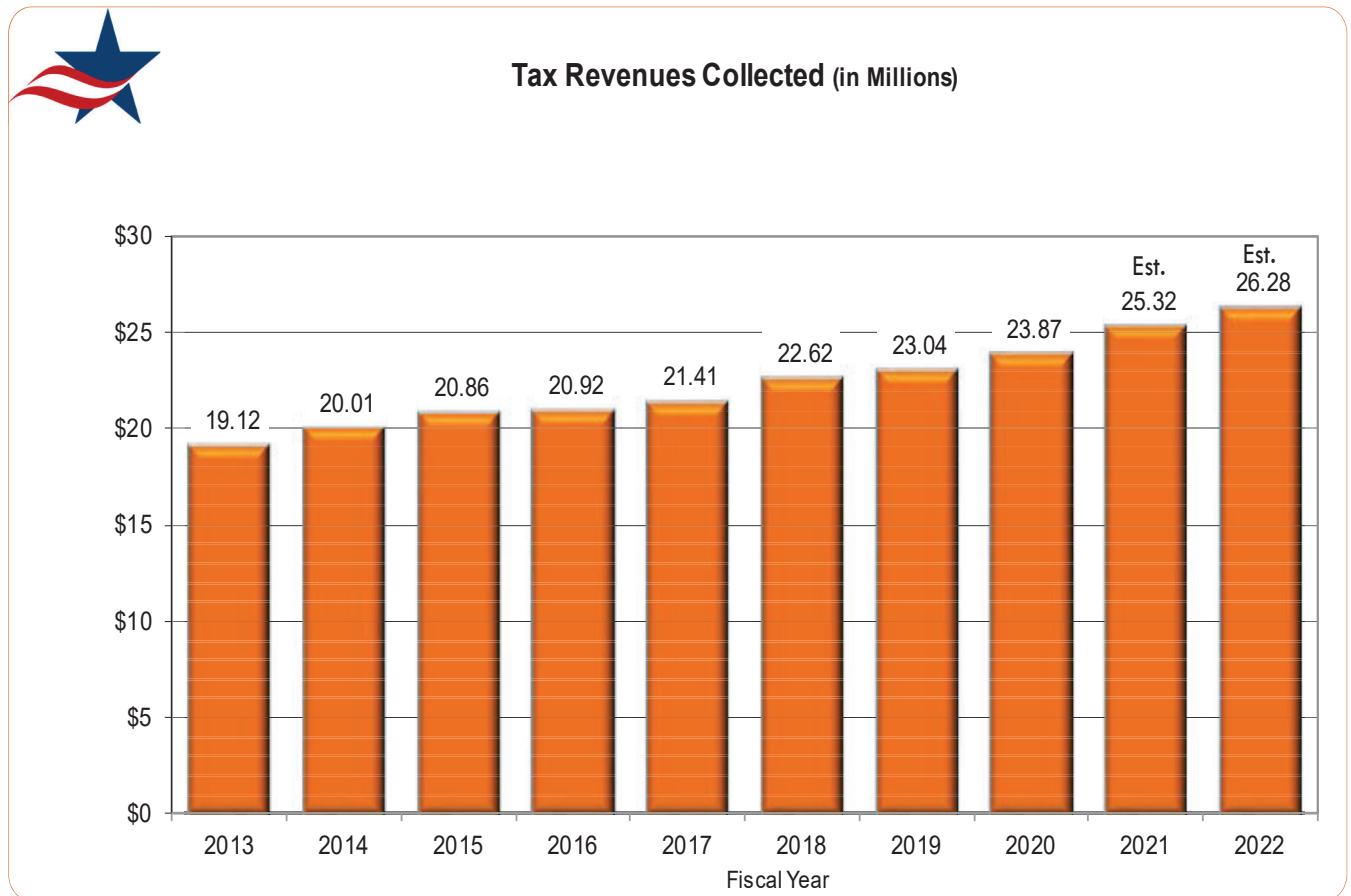

### Other 2021-2022 HCDE Budget Highlights

#### Salary Increase –

The proposed budget includes a \$15 an hour minimum compensation plan and a 2% for all employees for General Fund, Facilities and Enterprise employees. HCDE plans to recruit, hire, and retain high quality staff to be able to provide the best services available in the marketplace. The new beginning teacher salary will be \$62,800 which is expected to be at the highest level for the region. Grant employees are only included in the increase if the grant can absorb the cost. For the Head Start Program, a \$300,000 additional transfer from General Fund will be required for FY 22 to implement the \$15 minimum compensation plan.

#### Other Payroll Highlights –

Additionally, included in the budget are 7.5 new positions which included 1.5 therapists for the School Based Therapy Division, 2 Instructional Coaches for Head Start and 4 FTE for Adult Education.

#### Workers Compensation Insurance –

The amount of \$400,000 was budgeted for fiscal year 2021-2022. There are sufficient funds in the reserve account for uncertainties and to cover any runoff claims.

#### Transfers Out –

The amount of transfers out decreased by \$8,409,505 from fiscal year 2020-2021, for a total of \$5,449,088. This includes the Head Start transfer for \$600,000, the CASE transfer for \$550,787, Lease (QZAB) fund transfer for \$451,429, the capital projects for \$1,121,000, the Debt Service transfer for \$2,405,785, and the Star Re-Imagined one-time transfer for \$320,087.

**Transfers In –**

Choice Partners Cooperative is an Enterprise Fund with excess funds transferred to the General Fund to support the mission of HCDE. The total transfer (revenue to General Fund) is \$4,054,412.

Below is the five-year all Funds forecast for Harris County Department of Education. The assumption is that revenues will grow at a 3% rate and appropriation will grow at a 2% rate for the estimated years below.

**Harris County Department of Education  
All Funds Revenues and Expenditures  
Five Year Forecast**

	Actual 2017-18	Actual 2018-19	Actual 2019-20	Amended 2020-21	Proposed 2021-22	Estimated 2022-23	Estimated 2023-24	Estimated 2024-25	Estimated 2025-26	Estimated 2026-27
Beginning Fund Balance	\$40,427,732	\$42,583,959	45,676,310	\$38,633,589	\$78,253,024	\$48,136,225	\$21,186,111	\$20,399,620	\$20,399,620	\$20,291,447
Estimated Revenues	97,104,537	105,155,340	100,243,233	167,188,004	124,117,737	124,487,287	127,381,032	130,611,815	132,721,981	136,002,338
Appropriations (Exp.)	94,948,310	102,062,989	107,285,954	127,568,569	154,234,536	151,437,401	128,167,523	130,719,988	132,120,183	134,755,143
Difference	2,156,227	3,092,351	(7,042,721)	39,619,435	(30,116,799)	(26,950,114)	(786,491)	(108,173)	601,797	1,247,195
<b>Projected Ending Fund Balance</b>	<b>\$42,583,959</b>	<b>\$45,676,310</b>	<b>\$38,633,589</b>	<b>\$78,253,024</b>	<b>\$48,136,225</b>	<b>\$21,186,111</b>	<b>\$20,399,620</b>	<b>\$20,291,447</b>	<b>\$21,001,418</b>	<b>\$21,538,642</b>
Nonspendable Fund Balance	128,037	169,805	177,243	177,243	177,243	177,243	177,243	177,243	177,243	177,243
Restricted Fund Balance	11,219,387	10,600,127	2,939,650	32,446,770	14,239,592	2,939,650	2,939,650	2,939,650	2,939,650	2,939,650
Committed Fund Balance	2,014,976	2,014,976	2,014,976	2,014,976	2,014,976	2,014,976	2,014,976	2,014,976	2,014,976	2,014,976
Assigned Fund Balance	9,466,397	9,499,397	13,540,000	13,540,000	5,449,088	5,449,088	5,449,088	5,449,088	5,449,088	5,449,088
Unassigned Fund Balance	19,755,162	23,392,005	19,961,720	30,074,035	26,255,326	10,605,154	9,818,663	9,710,490	10,420,461	10,957,685
<b>Cash Flow Required two months</b>	<b>15,824,718</b>	<b>17,010,498</b>	<b>17,880,992</b>	<b>21,261,428</b>	<b>25,705,756</b>	<b>25,239,567</b>	<b>21,361,254</b>	<b>21,786,665</b>	<b>22,020,031</b>	<b>22,459,190</b>
<b>Cash Flow Needed for one month:</b>										
- For Special Revs Funds	2,445,621	2,870,235	3,463,105	3,246,100	4,005,319	4,085,426	4,167,134	4,250,477	4,250,477	4,335,486
- From General Fund	5,466,738	5,635,014	5,477,391	7,384,614	8,847,559	8,534,358	6,513,493	6,642,855	6,759,538	6,894,109
Cash Flow Calculations:										
Special Revenue Funds - Grants	29,347,454	34,442,824	41,557,265	38,953,199	48,063,832	49,025,109	50,005,611	51,005,723	51,005,723	52,025,837
1/12 of Total Grant is (one month)	2,445,621	2,870,235	3,463,105	3,246,100	4,005,319	4,085,426	4,167,134	4,250,477	4,250,477	4,335,486
All Funds - Appropriations	65,600,856	67,620,165	65,728,689	88,615,370	106,170,704	102,412,293	78,161,912	79,714,265	81,114,460	82,729,305
1/12 of General Fund for Cash Flow	5,466,738	5,635,014	5,477,391	7,384,614	8,847,559	8,534,358	6,513,493	6,642,855	6,759,538	6,894,109

Note: To reflect the actual events of the construction projects during fiscal year 2020-2121 the amended numbers were also adjusted to reflect expenditures over multiple years.

**Going forward beyond fiscal year 2021-2022**

Estimated revenues and appropriations for the next five years will depend on the ability for HCDE to remain implementing a positive business model that will maximize fee structure, grant resources, and

leverage local tax dollars. The ability to remain competitive in the market relies on maintaining a knowledgeable and expert work force, safe and secured facilities, 21<sup>st</sup> century technology, and relevant program and services that client districts and governmental entities need and seek from HCDE.

The future financial situation of HCDE would be the result of the collective Department effort to become a major player in three areas: **(1) Therapy Services:** HCDE's objective is to become the best source of therapy services for the schools in Harris County by offering competitive rates and top of the line services; **(2) Special Schools:** HCDE provides excellent services in schools designed to provide education to students with special needs. HCDE looks forward to expanding its clientele to new schools in other areas of the Harris County, such is the case of the Fortis Academy; **(3) Choice Partners:** HCDE provides benefit to school districts in Harris County and other clients by complying with the procurement requirements and vendors in all service areas. Out of every transaction, the vendors that supply Choice Partners members pay a commission as revenue for Choice. After Choice expenses are covered, the remaining excess is transferred to the General Fund to fund HCDE programs that benefit our community and students.

One of HCDE main goals is recruiting, hiring, and retaining high quality staff. Regarding personnel staffing trends, HCDE maintains the minimum level of staff required to provide good quality services. The HCDE advantage is that can utilize tax revenues to provide quality services.

### Acknowledgements

In fiscal year 2020-2021, the Business Office earned the Distinguished Budget Presentation Award for Budgeting from ASBO, and the Distinguished Budget Presentation Award from GFOA. This was the twelfth submission for ASBO and the thirteenth submission for GFOA for HCDE in its history. All budget managers also were instrumental in providing timely information to the Business Office.

### Final Comments

The preparation of the Department's budget is a coordination of many efforts from divisions, Research & Evaluation, Human Resources, Technology and Business Support Services. We are excited about the performance-based budgeting and look forward to FY 2021-2022. We thank the Budget Team that coordinated the wealth of information before you and we look forward to your input and feedback on our financial and operations plan.

Respectfully,

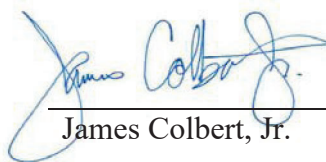

---

James Colbert, Jr.

County School Superintendent

---

Jesus Amezcua, PhD, CPA, RTSBA  
Assistant Superintendent for Business Services

# Harris County Department of Education

## 2021-22 Salary Schedule



**Harris County Department of Education**  
**FY 2021-2022 Salary Schedule**  
**Certified Instructional Staff Salary Schedule**

<b>New Hire Certified Teachers</b>	
YEARS EXPERIENCE	191 DAY SALARY
0	\$62,800
1	63,250
2	63,950
3	64,750
4	65,250
5	65,936
6	66,614
7	67,014
8	67,414
9	67,814
10	68,214
11	68,614
12	69,014
13	69,412
14	69,812
15	70,231
16	70,642
17	71,054
18	71,414
19	72,060
20	72,672

This schedule shows minimum salaries only. Some employees are paid more than these amounts for additional duty days or stipends. Salary schedules are developed for one year only. Future salaries cannot be predicted from this schedule.

This schedule is used for Chapter 21 contract teachers and transition specialists employed in the Schools division.



**Harris County Department of Education**  
**FY 2021-2022 Budget Book**  
**Administrative Salary Schedule**

<b>A-1</b>		<b>MINIMUM</b>	<b>MIDPOINT</b>	<b>MAXIMUM</b>
	<b>Daily</b>	164.63	202.00	239.37
	<b>230 Days</b>	37,865	46,460	55,055
	<b>240 Days</b>	39,511	48,480	57,449
<u>Job Titles:</u> Assistant Center Manager – Head Start Family Services Provider – Head Start Junior Staff Accountant – Business Services				

<b>A-2</b>		<b>MINIMUM</b>	<b>MIDPOINT</b>	<b>MAXIMUM</b>
	<b>Daily</b>	195.09	239.37	283.65
	<b>190 Days</b>	37,067	45,480	53,894
	<b>230 Days</b>	44,871	55,055	65,240
	<b>240 Days</b>	46,822	57,449	68,076
<u>Job Titles:</u> Associate – Center for Grants Development Career Pathways Transition Specialist – Adult Education Data Coordinator – CASE Family Engagement Coordinator Program Coordinator – CASE Project Based Learning Associate Teacher (FT) – Adult Education				

<b>A-3</b>		<b>MINIMUM</b>	<b>MIDPOINT</b>	<b>MAXIMUM</b>
	<b>Daily</b>	235.47	288.92	342.37
	<b>200 Days</b>	47,094	57,784	68,474
	<b>230 Days</b>	54,158	66,452	78,745
	<b>240 Days</b>	56,513	69,341	82,169
	<u>Job Titles:</u> Benefits Coordinator – Human Resources Center Manager – Head Start Compliance Coordinator – Head Start Contract Coordinator – Choice Partners Coordinator – Center for Grants Development Coordinator – Communications and Creative Services Coordinator – Food Contracts Coordinator – Grants & Budget Compliance Coordinator – Human Resources Coordinator – Marketing and Client Engagement Coordinator – Outreach Coordinator – Research and Evaluation Institute Coordinator – Special Projects Data Coordinator – Head Start Education and Special Services Coordinator – Head Start Family and Community Coordinator – Head Start Health Services Coordinator – Head Start Human Resources Generalist Nutrition Services Coordinator – Head Start Operations Coordinator – Facilities Operations Coordinator – Head Start Parent Engagement Liaison – Schools Procurement Coordinator – Purchasing Professional Development Coordinator – Head Start Project Coordinator – CASE Records Operations Manager Special Events and Promotions Coordinator – CASE Staff Accountant – Business Services			

<b>A-4</b>		<b>MINIMUM</b>	<b>MIDPOINT</b>	<b>MAXIMUM</b>
	<b>Daily</b>	287.27	352.48	417.69
	<b>210 Days</b>	60,327	74,021	87,715
	<b>240 Days</b>	68,945	84,595	100,246
<u>Job Titles:</u> Client Services Manager – Choice Partners Community Partnerships Manager – Head Start Compliance Manager – Head Start Contract Compliance Specialist – Choice Partners Contract Manager – Choice Partners Education and Special Services Manager – Head Start Grants Development Manager – Educator Certification Grants Development Specialist – Center for Grants Development Manager – Center for Grants Development Manager – Communications and Creative Services Manager – Facilities Manager – Programs & Compliance Manager – Research and Evaluation Institute Manager – Teaching and Learning Center Nutrition Manager – Head Start Operations Manager – Head Start Public Information and Policy Manager Quality Manager – CASE Special Initiatives Manager – CASE				

<b>A-5</b>		<b>MINIMUM</b>	<b>MIDPOINT</b>	<b>MAXIMUM</b>
	<b>Daily</b>	337.26	413.81	490.36
	<b>210 Days</b>	70,825	86,900	102,976
	<b>240 Days</b>	80,942	99,314	117,686
<u>Job Titles:</u> Accounting Manager – Business Services Assistant Director – CASE Assistant Director – Choice Partners Assistant Director – Head Start Assistant Director – Head Start Child Care Partnership Assistant Director – Human Resources Assistant Director – Marketing and Client Engagement Assistant Director - Operations Assistant Director – Purchasing Assistant Principal – Schools Budget and Investment Analyst – Business Services Compliance & Technology Support Officer Construction Project Manager – Head Start Manager – Adult Education School Climate and Culture Specialist – Safe Schools School Safety and Security Specialist – Safe Schools Senior Accountant – Business Services Senior Manager of Facilities Planning – Choice Partners				

<b>A-6</b>		<b>MINIMUM</b>	<b>MIDPOINT</b>	<b>MAXIMUM</b>
	<b>Daily</b>	375.94	450.23	524.52
	<b>200 Days</b>	75,188	90,046	104,904
	<b>240 Days</b>	90,226	108,055	125,885
<u>Job Titles:</u> Construction Director – Facilities Curriculum and Compliance Officer – Educator Certification Curriculum Director of English Language Arts Curriculum Director of Innovation Curriculum Director of Mathematics Curriculum Director of Science Director – Special Projects Director – Teaching and Learning Center Leadership Development Officer – Educator Certification Maintenance Director – Facilities				

<b>A-7</b>		<b>MINIMUM</b>	<b>MIDPOINT</b>	<b>MAXIMUM</b>
	<b>Daily</b>	426.69	511.01	595.33
	<b>230 Days</b>	98,139	117,532	136,926
	<b>240 Days</b>	102,406	122,642	142,879
<u>Job Titles:</u> Chief Accounting Officer – Business Services Director – Adult Education Director – Center for After-school, Summer and Enrichment Director – Center for Grants Development Director – Center for Safe and Secure Schools Director Director – Communications and Creative Services Director – Curriculum and Compliance Services Director – Educator Certification and Advancement Director – Marketing and Client Engagement Director – Purchasing Director – Records Management Director – Research and Evaluation Institute Principal – Schools				

<b>A-8</b>		<b>MINIMUM</b>	<b>MIDPOINT</b>	<b>MAXIMUM</b>
	<b>Daily</b>	495.17	582.55	669.93
	<b>240 Days</b>	118,841	139,812	160,783
	<u>Job Titles:</u> Senior Director – Adult Education Senior Director – Choice Partners Senior Director – Head Start Senior Director – School-Based Therapy Services Senior Director – Schools Senior Director – Teaching and Learning Center			

<b>A-9</b>		<b>MINIMUM</b>	<b>MIDPOINT</b>	<b>MAXIMUM</b>
	<b>Daily</b>	576.87	678.67	780.47
	<b>240 Days</b>	138,449	162,881	187,313
	<u>Job Titles:</u> Chief Communications Officer Chief of Staff Executive Director – Facilities Executive Director – Human Resources			

<b>A-10</b>		<b>MINIMUM</b>	<b>MIDPOINT</b>	<b>MAXIMUM</b>
	<b>Daily</b>	640.90	754.00	867.10
	<b>240 Days</b>	153,816	180,960	208,104
	<u>Job Titles:</u> Assistant Superintendent – Academic Support Services Assistant Superintendent – Business Services Assistant Superintendent – Education and Enrichment			

**Harris County Department of Education**  
 FY 2021-2022 Budget Book  
 Professional Support Salary Schedule

<b><u>P-1</u></b>		<b>Minimum</b>	<b>Midpoint</b>	<b>Maximum</b>
	<b>Daily</b>	293.25	345.00	396.75
	<b>180 Days</b>	52,785	62,100	71,415
	<b>191 Days</b>	56,011	65,895	75,779
	<b>213 Days</b>	62,462	73,485	84,508
	<u>Job Titles:</u> Music Therapist Nurse			

<b><u>P-2</u></b>		<b>Minimum</b>	<b>Midpoint</b>	<b>Maximum</b>
	<b>Daily</b>	316.71	372.60	428.49
	<b>200 Days</b>	63,342	74,520	85,698
	<b>230 Days</b>	72,843	85,698	98,553
	<u>Job Titles:</u> Behavior Intervention Specialist Instructional Coach Licensed Specialist in School Psychology Mental Health Professional School Counselor			

<b><u>P-3</u></b>		<b>Minimum</b>	<b>Midpoint</b>	<b>Maximum</b>
	<b>Daily</b>	355.65	428.49	501.33
	<b>162 Days</b>	57,615	69,415	81,215
	<b>180 Days</b>	64,017	77,128	90,239
	<b>200 Days</b>	71,130	85,698	100,266
	<u>Job Titles:</u> Occupational Therapist Physical Therapist			

<b><u>P-4</u></b>		<b>Minimum</b>	<b>Midpoint</b>	<b>Maximum</b>
	<b>Daily</b>	419.66	505.62	591.58
	<b>200 Days</b>	83,932	101,124	118,316
	<b>230 Days</b>	96,522	116,293	136,063
	<b>240 Days</b>	100,718	121,349	141,979
	<u>Job Titles:</u> Manager, School-Based Therapy Services			

**Harris County Department of Education**  
 FY 2021-2022 Budget Book  
 Technology Salary Schedule

<b><u>T-1</u></b>		<b>Minimum</b>	<b>Midpoint</b>	<b>Maximum</b>
	<b>Daily</b>	186.56	223.60	260.64
	<b>240 Days</b>	44,774	53,664	62,554
	<u>Job Titles:</u> Help Desk Analyst I Help Desk Field Technician			

<b><u>T-2</u></b>		<b>Minimum</b>	<b>Midpoint</b>	<b>Maximum</b>
	<b>Daily</b>	228.00	270.64	315.28
	<b>240 Days</b>	54,720	64,954	75,667
	<u>Job Titles:</u> Graphic Designer Help Desk Analyst II Multimedia Specialist			

<b><u>T-3</u></b>		<b>Minimum</b>	<b>Midpoint</b>	<b>Maximum</b>
	<b>Daily</b>	298.07	356.97	415.87
	<b>240 Days</b>	71,537	85,673	99,809
	<u>Job Titles:</u> Infrastructure Analyst – Network Infrastructure Analyst – Server Storage Systems Engineer – Data Center Systems Engineer – Hybrid Cloud			

<b><u>T-4</u></b>		<b>Minimum</b>	<b>Midpoint</b>	<b>Maximum</b>
	<b>Daily</b>	318.75	381.74	444.73
	<b>240 Days</b>	76,500	91,618	106,735
	<u>Job Titles:</u> Information Security Officer Manager – Graphic Design Manager – Help Desk Manager – Multimedia Software Developer Systems Analyst Web Content Coordinator			

<b><u>T-5</u></b>		<b>Minimum</b>	<b>Midpoint</b>	<b>Maximum</b>
	<b>Daily</b>	373.47	439.38	505.29
	<b>240 Days</b>	89,633	105,451	121,270
	<u>Job Titles:</u> Senior Software Developer Senior Systems Analyst			

<b><u>T-6</u></b>		<b>Minimum</b>	<b>Midpoint</b>	<b>Maximum</b>
	<b>Daily</b>	406.90	478.70	550.51
	<b>240 Days</b>	97,656	114,888	132,122
	<u>Job Titles:</u> Manager – Applications Manager – Operations Support			

<b><u>T-7</u></b>		<b>Minimum</b>	<b>Midpoint</b>	<b>Maximum</b>
	<b>Daily</b>	462.28	531.36	600.44
	<b>240 Days</b>	110,947	127,526	144,106
	<u>Job Titles:</u> Director - Information Technology Services			



**Harris County Department of Education**  
 FY 2021-2022 Budget Book  
 Administrative Support Salary Schedule

<b>S-1</b>		<b>MINIMUM</b>	<b>MIDPOINT</b>	<b>MAXIMUM</b>
	<b>Hourly</b>	13.88	17.35	20.82
	<b>Daily</b>	111.04	138.80	166.56
	<b>240 Days</b>	26,650	33,312	39,974
<u>Job Titles:</u> Reserved for future use				

<b>S-2</b>		<b>MINIMUM</b>	<b>MIDPOINT</b>	<b>MAXIMUM</b>
	<b>Hourly</b>	15.00	18.74	22.48
	<b>Daily</b>	120.00	149.92	179.84
	<b>210 Days</b>	25,200	31,483	37,766
	<b>230 Days</b>	27,600	34,482	41,363
	<b>240 Days</b>	28,800	35,981	43,162
<u>Job Titles:</u> Campus Clerk Center Clerk Receptionist				

<b>S-3</b>		<b>MINIMUM</b>	<b>MIDPOINT</b>	<b>MAXIMUM</b>
	<b>Hourly</b>	16.19	20.24	24.29
	<b>Daily</b>	129.52	161.92	194.32
	<b>230 Days</b>	29,790	37,242	44,694
	<b>240 Days</b>	31,085	38,861	46,637
<u>Job Titles:</u> Community Partnership Clerk – Head Start Contract Clerk – Choice Partners Customer Service Clerk Data Clerk – Adult Education General Office Clerk I Human Resources Clerk Imaging Operator – Records Management Meeting Facilitator Nutrition Services Clerk – Head Start Operations Clerk – Head Start Secretary – CASE Secretary – School-Based Therapy Services				

<b>S-4</b>		<b>MINIMUM</b>	<b>MIDPOINT</b>	<b>MAXIMUM</b>
	<b>Hourly</b>	17.93	22.40	26.87
	<b>Daily</b>	143.44	179.20	214.96
	<b>230 Days</b>	32,991	41,216	49,441
	<b>240 Days</b>	34,426	43,008	51,590
<u>Job Titles:</u> Data/Compliance Specialist Financial Assistant Fixed Assets Clerk Food Contract Assistant General Office Clerk II Microfilm/Imaging Clerk Records Management Specialist Secretary to Director Secretary to Principal				

<b>S-5</b>		<b>MINIMUM</b>	<b>MIDPOINT</b>	<b>MAXIMUM</b>
	<b>Hourly</b>	20.09	25.12	30.15
	<b>Daily</b>	160.72	200.96	241.20
	<b>230 Days</b>	36,966	46,221	55,476
	<b>240 Days</b>	38,573	48,230	57,888
<u>Job Titles:</u> Accounts Payable Specialist Accounts Receivable Specialist Administrative Assistant – Executive Director Administrative Assistant – Senior Director Benefits Specialist Contract Specialist Financial Assistant/Adm Assistant – Senior Director Imaging and Content Specialist Payroll Specialist Purchasing Specialist Quality Assurance Specialist Senior Grant Accounting Clerk				

<b>S-6</b>		<b>MINIMUM</b>	<b>MIDPOINT</b>	<b>MAXIMUM</b>
	<b>Hourly</b>	23.10	28.88	34.66
	<b>Daily</b>	184.80	231.04	277.28
	<b>240 Days</b>	44,352	55,450	66,547
<u>Job Titles:</u> Executive Assistant – Assistant Superintendent Executive Assistant – Board of Trustees Secretary – Director				

<b>S-7</b>		<b>MINIMUM</b>	<b>MIDPOINT</b>	<b>MAXIMUM</b>
	<b>Hourly</b>	26.80	33.50	40.20
	<b>Daily</b>	214.40	268.00	321.60
	<b>162 Days</b>	34,733	43,416	52,099
	<b>180 Days</b>	38,592	48,240	57,888
<u>Job Titles:</u> Occupational Therapy Assistant Physical Therapist Assistant				

<b>S-8</b>		<b>MINIMUM</b>	<b>MIDPOINT</b>	<b>MAXIMUM</b>
	<b>Hourly</b>	30.83	38.53	46.23
	<b>Daily</b>	246.64	308.24	369.84
	<b>240 Days</b>	59,194	73,978	88,762
<u>Job Titles:</u> Senior Executive Assistant – Superintendent				

**Harris County Department of Education**  
**FY 2021-2022 Budget Book**  
**Operations Support Salary Schedule**

<b><u>O-1</u></b>		<b>MINIMUM</b>	<b>MIDPOINT</b>	<b>MAXIMUM</b>
	<b>Hourly</b>	15.00	18.29	21.58
	<b>Daily</b>	120.00	146.32	172.64
	<b>190 Days</b>	22,800	27,801	32,802
	<b>218 Days</b>	26,160	31,898	37,636
	<b>240 Days</b>	28,800	35,117	41,434
<b>Job Titles:</b> Cook Custodian				

<b><u>O-2</u></b>		<b>MINIMUM</b>	<b>MIDPOINT</b>	<b>MAXIMUM</b>
	<b>Hourly</b>	15.89	19.39	22.89
	<b>Daily</b>	127.12	155.12	183.12
	<b>191 Days</b>	24,280	29,628	34,976
	<b>230 Days</b>	29,238	35,678	42,118
	<b>240 Days</b>	30,509	37,229	43,949
<b>Job Titles:</b> Courier Food Service Clerk Parking Monitor				

<b><u>O-3</u></b>		<b>MINIMUM</b>	<b>MIDPOINT</b>	<b>MAXIMUM</b>
	<b>Hourly</b>	16.86	20.55	24.24
	<b>Daily</b>	134.88	164.40	193.92
	<b>240 Days</b>	32,371	39,456	46,541
<b>Job Titles:</b> Maintenance Worker Warehouseman				

<b><u>O-4</u></b>		<b>MINIMUM</b>	<b>MIDPOINT</b>	<b>MAXIMUM</b>
	<b>Hourly</b>	19.95	24.04	28.13
	<b>Daily</b>	159.60	192.32	225.04
	<b>240 Days</b>	38,304	46,157	54,010
<b>Job Titles:</b> Bus Driver Construction and Environmental Specialist Maintenance Technician I Records Center Technician				

<b><u>O-5</u></b>		<b>MINIMUM</b>	<b>MIDPOINT</b>	<b>MAXIMUM</b>
	<b>Hourly</b>	23.91	28.13	32.35
	<b>Daily</b>	191.28	225.04	258.80
	<b>240 Days</b>	45,907	54,010	62,112
	<b>Job Titles:</b> Maintenance Technician II Transportation Technician Utility Craftsman			

<b><u>O-6</u></b>		<b>MINIMUM</b>	<b>MIDPOINT</b>	<b>MAXIMUM</b>
	<b>Hourly</b>	27.50	32.35	37.20
	<b>Daily</b>	220.00	258.80	297.60
	<b>240 Days</b>	52,800	62,112	71,424
	<b>Job Titles:</b> Maintenance Technician III Senior Records Center Technician Specialist, Maintenance Project			

**Harris County Department of Education**  
 FY 2021-2022 Budget Book  
 Instructional Support Salary Schedule

<b><u>I-1</u></b>		<b>MINIMUM</b>	<b>MIDPOINT</b>	<b>MAXIMUM</b>
	<b>Hourly</b>	15.00	18.29	21.58
	<b>Daily</b>	120.00	146.32	172.64
	<b>190 Days</b>	22,800	27,801	32,802
	<b>191 Days</b>	22,920	27,947	32,974
<b>Job Titles:</b> Educational Aide I - Schools Teaching Assistant - Head Start				

<b><u>I-2</u></b>		<b>MINIMUM</b>	<b>MIDPOINT</b>	<b>MAXIMUM</b>
	<b>Hourly</b>	16.20	19.76	23.32
	<b>Daily</b>	129.60	158.08	186.56
	<b>191 Days</b>	24,754	30,193	35,633
	<b>218 Days</b>	28,253	34,461	40,670
<b>Job Titles:</b> Educational Aide II - Schools Teacher (CDA) – Early Head Start				

<b><u>I-3</u></b>		<b>MINIMUM</b>	<b>MIDPOINT</b>	<b>MAXIMUM</b>
	<b>Hourly</b>	18.61	22.70	26.79
	<b>Daily</b>	148.88	181.60	214.32
	<b>191 Days</b>	28,436	34,686	40,935
<b>Job Titles:</b> Educational Aide III - Schools				

<b><u>I-4</u></b>		<b>MINIMUM</b>	<b>MIDPOINT</b>	<b>MAXIMUM</b>
	<b>Hourly</b>	22.78	26.79	30.80
	<b>Daily</b>	182.24	214.32	246.40
	<b>210 Days</b>	38,270	45,007	51,744
	<b>218 Days</b>	39,728	46,722	53,715
<b>Job Titles:</b> Early Childhood Teacher – Early Childhood Head Start Teacher - Head Start				

**Harris County Department of Education**  
 FY 2021-2022 Budget Book  
 Stipends

<b>Certified Instructional Teachers</b>	
Advanced Degree* (Subject Area)	\$1,000
HCDE Identified Critical Needs Stipends:	
Bilingual	\$4,200
Board Certified Behavior Analyst	5,000
Math	3,500
Reading	2,000
Science	3,500
Special Education	1,500
Additional Certificate	150
<b>Certified SBEC Counselors</b>	
Special Education	\$1,500
STAAR/EOC Testing	1,000
<b>Certified SBEC Assistant Principals</b>	
Special Education	\$1,500
<b>Response Team Member</b>	
Assigned AB Campus Staff	\$1,500

\*Effective August 1, 2011, the Advanced Degree Stipend will only be awarded to certified teachers hired on or after August 1, 2011 who possess an advanced degree specific to his/her assigned subject area.

A stipend shall not be paid to an employee unless it is part of the Board of Trustees' approved Salary Schedule for certified instructional teachers, counselors, and assistant principals. All of the following recommendations for employee stipends must be made directly to the Board: certification, additional work duties, added assignments, or any other requests.

**Harris County Department of Education**  
 FY 2021-2022 Budget Book  
 Substitutes Pay Chart

<b>POSITION</b>	<b>Pay Rate</b>
Educational Aide I	\$120/day
Educational Aide II	\$129/day
Educational Aide III	\$148/day
Teacher (Degree Only)	\$200/day
Teacher (TX Teacher Certificate)	\$260/day
Bus Driver	\$18/hour

Relief Instructor Pay Chart

<b>POSITION</b>	<b>Pay Rate</b>
Teacher (Degree Only)	\$200/day
Teacher (TX Teacher Certificate)	\$260/day



**Harris County Department of Education**  
 FY 2021-2022 Budget Book  
 Supplemental Salary Chart

<b>Adult Education</b>	
Aide with High School Diploma	\$15.00/hour
Aide with 12 College Credit Hours	\$15.50/hour
Career Pathways Instructor	\$40.00/hour
Clerk	\$15.00/hour
Counselor	\$37.00/hour
Craft Instructor	\$40.00/hour
Program Assistant	\$30.00/hour
Registration	\$25.00/hour
Substitute Teacher	\$22.00/hour
Substitute Tester	\$22.00/hour
Teacher-Summer and TRS Retired	\$27.00/hour
Tester	\$25.00/hour
Transition Specialist	\$27.00/hour
Teacher (GED class) – 6 weeks	\$1,620/session
Teacher (ESL class) – 6 weeks	\$1,620/session
<b>Head Start</b>	
Assistant Cook	\$2,000/year
Cook Supplemental Pay	\$1.75/hour
Early Head Start Center Management	\$3,000/year
Healthy Living Catering/Policy Council	\$2,000/year
Substitute Teaching Assistant	\$15.00/hour
Teaching Assistant Supplemental Pay	\$1.61/hour
Translator – Policy Council	\$25.00/hour
<b>Special Schools</b>	
Administrator – Summer/Extra Duty Pay	\$29.00/hour
Bus Aide	\$15.00/hour
Bus Driver	\$500/year
Counselor – Summer/Extra Duty Pay	\$27.00/hour
Educational Aide – Summer/Extra Duty Pay	\$17.00/hour
Home Bound Student Services	\$40.00/hour
Teacher-Summer/Extra Duty Pay	\$27.00/hour
Trainer Pay – Boys Town and Love & Logic	\$35.00/hour

<b>Interns</b>	
High School Student	\$15.00/hour
College Student	\$17.00/hour
<b>Teaching and Learning Center</b>	
Curriculum Director	\$60.00/hour

**Harris County Department of Education**  
 FY 2021-2022 Budget Book  
 Adult Education Professional Development Stipends

**Eligibility:** part-time and full-time staff

<b>Position</b>	<b>Required Hours</b>	<b>Category of Required Professional Development</b>	<b>Stipend</b>
<ul style="list-style-type: none"> <li>• Teacher</li> <li>• Substitute</li> <li>• Instructional Coach</li> <li>• Program Manager</li> <li>• Program Coordinator</li> <li>• Director</li> </ul>	15	3 hours – Principles of Adult Learning 6 hours – Literacy 6 hours – Other	\$300
<ul style="list-style-type: none"> <li>• Clerk</li> <li>• Aide</li> <li>• Transition Specialist</li> </ul>	3	3 hours – Other	\$40
Additional training	N/A	Paid at hourly rate if required and approved.  *Excludes the following positions: director, program manager, instructional coach, program coordinator, and full-time teacher.	

# Harris County Department of Education

## FY 2021-2022 Budget Book

### Salary Schedule Procedures

## Compensation Philosophy Statement

The Superintendent shall develop and recommend a pay system for all Department personnel to the Board of Trustees for adoption. The pay system shall be designed to provide appropriate pay for the assessed worth of jobs. The system shall consist of pay range structures for the following employee groups: management, professional, certified instructional, clerical/paraprofessional, and technical. The system shall be designed and administered to accomplish the following:

- Remain competitive with appropriate labor markets for the various categories of personnel.
- Recognize the levels of skill, effort, and responsibility required of different jobs.
- Be fiscally controlled and cost effective.

## Administrative Procedures

### 1.0 Description Pay Systems

#### *1.1 Purpose and Authority*

Employee pay systems are designed and administered for the purpose of attracting and retaining qualified employees to achieve the goals of the Department. The Superintendent is responsible for the development, maintenance, and administration of employee pay systems in accordance with Board policies and administrative procedures.

#### *1.2 Minimum Pay Requirements*

Certified classroom teachers, librarians, registered nurses, and counselors will be paid no less than the state minimum salary schedule based on creditable experience. Experience will be credited according to the commissioner's rules on creditable service (19 TAC 153.1021). Local salaries for these employees will be determined annually after Board approval of the pay increase budget. Non-exempt employees will be paid no less than the current minimum wage in accordance with the federal Fair Labor Standards Act (FLSA).

#### *1.3 Pay Plans*

The Department will maintain position classification and pay range structures for all jobs. Jobs will be grouped into position classifications and pay range structures in the following categories: (1) managers, (2) professionals, (3) certified teachers, (4) clerical and paraprofessional, (5) maintenance and operations, and (6) technical.

Each job will be assigned to a pay grade that determines the minimum to maximum pay range for the position. Pay ranges are set to be competitive with the relevant job market for benchmark positions. Jobs are assigned to pay grades on the basis of the following factors: (1) job

qualifications and required skills; (2) job duties and responsibilities defined by the Department; and (3) competitive job market prices.

No employee will be paid more than the maximum rate for his/her pay grade unless the employee was earning more than that amount prior to the adoption of the pay plan. Pay ranges are reviewed annually and should be adjusted as needed. Employee salaries will advance through the pay range based upon the general pay increase budget approved by the Board each year.

## 2.0 Job Classification

### ***2.1 Purpose and Authority***

Job classification determines the assigned pay range for a job. Job classification is based on an assessment of job requirements and assigned duties. Jobs are compared and classified on the basis of the following factors: knowledge and skill requirements, complexity of assigned duties, job accountability, and working conditions. The Human Resources division will collect job information, evaluate jobs for classification purposes, and recommend pay-grade assignments. The Superintendent has final authority concerning job classifications.

### ***2.2 Reclassification of Current Positions***

A job reclassification occurs when the same position is moved to a higher or lower pay grade. An upward or downward job reclassification will result in greater or lesser potential for pay advancement over time. Jobs may be reclassified for a number of different reasons. Those reasons include a significant and sustained increase or decrease in job duties and responsibilities assigned by the supervisor, a need to improve internal pay equity with other related jobs, or a significant change in the external job market.

### ***2.3 Salary Adjustments for Job Reclassification***

- If the job is reclassified upward due to a significant and sustained increase in assigned job duties and responsibilities, the reclassification will be treated as a promotion. Refer to procedures on promotion increases (section 8.2).
- If the job is reclassified to improve internal equity with other related jobs and there is no significant and sustained increase in assigned duties, there will be no immediate pay increase. Future earnings will be higher as a result of placement in a higher pay range. Employees will not be paid less than the minimum of the new pay range.
- If the job is reclassified due to a change in the external job market, special equity adjustments may be made at the direction of the Superintendent. Refer to procedures on individual equity adjustments (section 6.0).
- If the job is reclassified downward due to a decrease in duties and responsibilities assigned, the employee's pay may be reduced at the direction of the Superintendent. In this case, the reclassification will be treated as a demotion. Refer to procedures on pay adjustments for demotion (section 9.2).

### ***2.4 Procedures for Job Classification Review***

Review of job classifications must be initiated by the job supervisor. Reviews will be conducted as

follows:

1. The immediate supervisor may request a job classification review according to the schedule and procedures designated by the Human Resources division.
2. The supervisor must submit a completed reclassification request form to the Human Resources division.
3. The Human Resources division will review the request form, obtaining additional job information if necessary. Additional information may be obtained by requesting a job analysis questionnaire, by interviewing the supervisor and/or employee(s), or by visiting the work site for observation.
4. The Human Resources division will re-evaluate the job against other benchmark jobs using standard compensable job factors.
5. The Human Resources division will prepare a written recommendation for pay grade assignment for the Superintendent's review.
6. The Human Resources division will notify the supervisor and the employee of the pay grade assignment after the Superintendent's review and approval.

### ***2.5 Classification of New Positions***

New positions must have a written job description. The Human Resources division will recommend to the Superintendent the pay grade classification of new positions based on the job description and consultation with the job supervisor. New positions must be classified in the pay system prior to hiring new employees.

## **3.0 Base Pay for Exempt and Non-exempt Employees**

### ***3.1 Classification of Positions as Exempt or Non-exempt***

All jobs will be classified as exempt or non-exempt in accordance with the requirements of the federal Fair Labor Standards Act (FLSA). The Human Resources division will determine the classification of each position based on a description of assigned job duties and the method of compensation. In order to be exempt, the employee's primary duties must fall under one of three types of exemption: executive, administrative, or professional, as defined under the FLSA, and the employee must be compensated on a salary basis. All employees who do not meet the legal requirements for exemption are classified as non-exempt.

### ***3.2 Salary Basis***

All full-time employees are paid on a salary basis for their annual employment period. Payment on a salary basis means that employees are paid a fixed sum for the job, which amount is paid out in equal installments. Exempt employees do not receive overtime compensation. Employees who are non-exempt will receive overtime compensation as described in section 4.0.

### ***3.3 Prorating Pay for Reduced Work Year***

Salaries will be adjusted proportionately for employees who work less than full time or less than a full year.

## **4.0 Overtime Compensation**

### ***4.1 Overtime Defined***

Non-exempt employees who work more than 40 hours in a workweek of seven consecutive days

are entitled to overtime compensation for time worked over 40 hours. Exempt employees (i.e., professional, administrative, and executive) are not entitled to overtime compensation. An employee's regular work schedule may be adjusted during the week to limit or eliminate overtime. The Department's workweek begins at 12:01 a.m. on Monday and ends at 12:00 midnight on the following Sunday. Overtime must be paid or accrued as compensatory time on the regular payday for the period in which the overtime workweek ended. Every workweek stands alone and different workweeks cannot be consolidated or averaged.

#### ***4.2 Time Records***

Weekly time records will be maintained on all non-exempt personnel on forms approved by the Department. Records will indicate all hours worked each week, including compensatory time earned and used. Weekly time records must be verified by the supervisor and submitted to payroll on designated dates. Official weekly time records shall be maintained in the central payroll office for all non-exempt personnel. All payroll records, including time records, shall be maintained for a period of three years, and shall be made available for inspection by government authorities on request. Failure to maintain accurate records of hours worked may result in disciplinary actions.

#### ***4.3 Authorization of Overtime***

All overtime worked must be approved by a supervisor in advance. Supervisors are responsible for preventing unauthorized overtime. Employees who work unauthorized overtime may be subject to disciplinary action. Supervisors of non-exempt employees must ensure that employees understand how they will be compensated for overtime (compensatory time off or cash) prior to the employee working overtime hours. Overtime pay requirements cannot be waived by voluntary agreement between the Department and the employee and the employee cannot "donate" overtime or agree to be paid at reduced rates.

#### ***4.4 Compensation for Overtime***

Compensation for overtime hours will be awarded at 1½ times the regular rate. Compensation may be given in compensatory time off or paid in the regularly scheduled paycheck.

#### ***4.5 Use of Compensatory Time***

Compensatory time may be accumulated up to a maximum limit of 40 hours including time-and-a-half rates. Employees who have accrued compensatory time must use that time before using other accrued leave. Compensatory time accrued must be used or paid before the end of each fiscal year. All unused compensatory time will be paid before the beginning of the new fiscal period.

## **5.0 General Pay Increases**

### ***5.1 Eligibility for General Pay Increase***

Employee salaries and wages will be reviewed annually for adjustment. General pay increases are given to employees to reward continued service to the Department. An employee's performance must be satisfactory to receive a pay increase unless exceptions are granted by the Board.

To be eligible for a general pay increase, 12-month employees must be employed by May 1 of the immediately preceding school year, 11-month employees must be employed by April 1, and 10-month employees must be employed by March 1.

### **5.2 Pay Increase Budget**

The Superintendent will recommend a total budget amount for general pay increases as part of the annual budget process. Budget recommendations for general pay increases will be based on available revenue, changes in minimum pay laws, competitive job markets, and Department compensation objectives. Employee pay increases will be based on the budget approved by the Board.

### **5.3 General Pay Increase Calculation**

General pay increases will be calculated for each employee by applying a percent increase approved by the Board to the midpoint of each employee's pay range. All employees who are in the same pay range will receive the same pay increase.

*Example:*

Range Midpoint x Percent Increase = Pay Increase

- Pay range midpoint for pay grade 5 is \$12.50 per hour
- Pay increase budget approved by the Board is 5 percent
- Hourly pay increase for all employees in pay grade 5 is  $\$12.50 \times .05 = .63$
- An hourly employee in pay grade 5 is earning \$11.50 per hour
- Employee's new hourly wage is  $\$11.50 + .63 = \$12.13$

No employee's pay will be increased beyond the maximum of their assigned pay range unless a special adjustment is approved by the Superintendent.

### **5.4 Head Start Cost of Living Adjustments**

HCDE Head Start employees receive Cost of Living Adjustments (COLA) from the Texas Department of Health and Human Services. Notice of the approved increase is generally received mid-calendar year. The COLA is effective January of the current budget year. In other words, the increase is usually retroactive, dating back to January 1 of the current year. In order to receive the COLA when the increase is applied to the payroll, an employee must be currently employed with the Head Start division. COLA adjustments are subject to any provisions specified by the Texas Department of Health and Human Services.

Example: If increases are calculated and applied to the September 15th payroll, then the employee must be a current employee in the Head Start division on this date. If employment is terminated (voluntary or involuntary), or if the employee transfers to another division prior to this date, then the employee is not eligible to receive the COLA.

## **6.0 Individual Equity Adjustments**

The Superintendent may make special equity adjustments to individual employee salaries to correct identified internal or external pay equity problems. Equity adjustments are made only on as-needed basis at the direction of the Superintendent. Equity adjustments may be made to retain an employee who is at risk due to competitive pay problems; to correct an internal pay inequity; or to compensate an employee for a significant change in job responsibilities that do not result in a



job classification change.

## 7.0 Placement of New Employees

### *7.1 Certified Teachers*

Hiring rates for certified teachers will be based on years of creditable service as defined by state regulations. Service credit awarded to new hires will not exceed 20 years. Salary schedules will be prepared annually to illustrate salary placement by years of service. Salary schedules for certified teachers are subject to change each year and should not be used to predict future salaries.

### *7.2 Other Employees*

Hiring rates for all other employees will be determined individually based on each person's job-related qualifications. Hiring rates should be sensitive to internal equity concerns of other employees in the same job. Starting salaries that are above the midpoint may be offered only for hard-to-fill positions with approval of the Superintendent. The Human Resources division will recommend starting salaries for new hires.

## 8.0 Promotion Increases

### *8.1 Promotion Defined*

A promotion occurs when an employee is assigned to a different job in a higher pay range. Pay adjustments for promotions will begin with the effective date of the new assignment. For promotions that take effect at the beginning of a school year, the standard promotion increase includes any general increase granted by the Board. If an employee moves to a different job in a different pay structure (example: from auxiliary to professional group), then the pay adjustment will be treated as placement of a new employee (see section 7.0).

### *8.2 Promotion Increase*

A promotion increase is based on an employee's current base pay less any stipends paid for supplemental duties. The Human Resources Director will determine salary placement for a promotion. Consideration will be given to the pay of other employees in the same position to maintain internal pay equity. No employee will be paid less than the minimum or more than the maximum of the new pay range.

## 9.0 Demotion

### *9.1 Demotion Defined*

A demotion occurs when an employee is reassigned to a different job at a lower pay grade level. Demotions may be voluntary or involuntary. Position reclassification or general salary structure changes are not considered demotions.

### *9.2 Pay Adjustments for Demotion*

A reduction in pay as a result of a demotion will be made at the discretion of the Superintendent. When a pay reduction is made for a demotion, the employee's base pay rate will be reduced. The pay adjustment for demotion will begin with the effective date of the new assignment. Pay

adjustments may also be made for a longer or shorter work year if associated with the change in assignment.

## 10.0 Adjusting Pay-Range Structures

### 10.1 Review of Pay Ranges

The Superintendent will review pay-range structures annually and make adjustments as needed.

### 10.2 Amount of Structure Adjustment

Pay structures should be adjusted by an equal percent factor. The amount of percent adjustment made to the pay range control points (minimum, midpoint, maximum) should be less than the percent increase budgeted for pay raises. After the pay increase budget is established, the Superintendent will determine the appropriate amount of adjustment for pay range structures in the Department.

### 10.3 Structure Adjustment Procedure

To adjust a pay range structure, the adjustment factor will be applied to the midpoint of each pay range. The minimum and maximum rates of each range will then be recalculated off of the adjusted midpoint to preserve the structure. Adjustments to pay ranges should be made prior to the calculation of general pay increases.

*Example: Illustrated procedure for a range offset of 20 percent from midpoints*

	Unadjusted <u>Minimum</u> (80% of midpoint) midpoint)	Unadjusted <u>Midpoint</u>	Unadjusted <u>Maximum</u> (120% of
<b>Unadjusted Pay Range</b>	\$2,400	\$3,000	\$3,600
	Unadjusted <u>Minimum</u> (80% of midpoint) midpoint)	Unadjusted <u>Midpoint</u> (by 2%)	Unadjusted <u>Maximum</u> (120% of
<b>Adjusted Pay Range</b>	\$2,448	\$3,060	\$3,600

## 11.0 Stipends and Allowances

A stipend shall not be paid to an employee unless it is part of the Board of Trustees' approved Salary Schedule for certified instructional teachers, transition specialists, counselors, and assistant principals. All of the following recommendations for employee stipends must be made directly to the Board: certification, additional work duties, added assignments, or any other requests. The superintendent is only authorized to provide allowances to employees for cell phones and travel.

Refer to the Supplemental Salary Chart for supplemental pay rates approved by the Board of Trustees as part of the HCDE Salary Schedule.

# Harris County Department of Education

## FY 2021-2022 Budget Book

### Employee Benefits

**Note: Contact Human Resources if you have any questions.**

HCDE provides the following Employer-Paid Benefits:

- Employee Assistance Program (EAP)  
HCDE's EAP program with Alliance Work Partners, provides for eight counseling sessions per issue/per year for benefits eligible employees and their family members. Issues can range from family problems, stress, alcohol/drug abuse, depression, anxiety, legal, and/or financial problems. HCDE pays \$2.31 per month (or \$27.72 annually) per employee.
- Life Insurance  
A basic \$15,000 life and \$15,000 accidental death policy is provided to all benefits eligible employees. HCDE's monthly cost for these policies is \$2.15 (or \$25.74 annually) per employee.
- Medical Insurance  
HCDE participates in the TRS ActiveCare Plan. Coverage is provided by Blue Cross Blue Shield. Employees may select coverage under TRS ActiveCare-HD, ActiveCare Primary or ActiveCare Primary Plus for coverage of the Employee, Employee & Spouse, Employee & Children, or Family. Employees already enrolled in TRS ActiveCare 2 may remain in the plan, but it is closed to new enrollments. All employees working 20 or more hours per week are eligible to enroll and receive employer/state contributions. HCDE contributes \$397.00 per month (or \$4,764 annually) for enrollees in the TRS Active Care plans.
- Social Security and Medicare Tax  
All HCDE employees must participate in the Social Security System. The tax rate is 6.2% for Social Security and 1.45% for Medicare for both the employee and the employer.
- Teacher Retirement System (TRS)  
In addition to the Social Security System, HCDE also participates in the Teacher Retirement System. Participation is mandatory for all HCDE employees working 20 or more hours per week. Employees contribute 7.7% to their TRS retirement account and 0.75% to TRS-Care. TRS-Care is a program designed to provide health benefits to eligible HCDE employees upon retirement. HCDE pays 0.75% of gross salary of each TRS active employee to TRS-Care. HCDE also contributes 1.7% of all eligible TRS compensation for the reporting entity payment for non-OASDI members. The State contributes a matching amount to the employee's TRS retirement fund of 6.8% less any amounts that are matched by federal grants.

- Unemployment Insurance  
HCDE provides unemployment insurance for all employees. HCDE pays a contribution on wages at a rate of 0.39%. Claims are managed by Corporate Cost Control, Inc.
- Workers Compensation Insurance  
All employees are protected by workers' compensation insurance. HCDE is insured with the Texas Association of School Business. The amount paid is determined by a percentage of the gross wages paid to employees in each of the above classifications. Coverage is provided for three classifications of employees:
  1. Professional (school or student associated personnel)
  2. Clerical (non-school or student associated personnel)
  3. All others (maintenance, custodial, couriers, cooks and records).

HCDE offers the following Employee Optional Benefits:

- Flexible Spending Account (FSA)  
As part of our Cafeteria Plan, employees may set aside pre-tax money to pay for out-of-pocket medical or dependent care expenses.
- Health Savings Account (HSA)  
Employees enrolled in the high deductible health plan may set aside pre-tax money to pay for out-of-pocket medical expenses.
- Voluntary Life Insurance  
Full time employees may purchase additional life insurance for themselves and their dependents.
- Retirement Plan (Voluntary)  
Employees may participate in the 403(b)-retirement savings plan and/or a 457-retirement savings plan. In both plans, money is set aside on a pretax basis to be invested in annuities and mutual funds.
- Vision Coverage  
Coverage includes a routine eye exam, glasses or contact lenses every 12 months.
- Dental Coverage  
Coverage has two plans to select from (DHMO and PPO) and includes routine preventative, restorative and periodontal services.
- Cancer Protection  
Supplemental coverage to provide cash benefits should an employee be diagnosed with cancer. Two levels of coverage are available.
- Disability Insurance  
Coverage provides long term salary protection when an employee is unable to work due to a disability.

- Prepaid Legal  
The plan provides services including wills, power of attorney, living trusts for employees and their spouses, traffic ticket defense (except DUI) contract review, assistance with identity issues, real estate and family matters.
- Identity Theft Protection  
Coverage has two levels of protections from which to select. Plans include credit monitoring, cyber alert internet surveillance, and full-service identity restoration.
- Accident Plan  
The plan has two levels of coverage from which to select. Coverage provides for some financial benefit to help with out-of-pocket costs associated with the emergency treatment of or hospitalization for a covered accident.
- Hospital Indemnity Plan  
The plan has two levels of coverage from which to select. Coverage provides for some financial benefit to help with out-of-pocket costs associated with the hospitalization for a covered illness or accident.
- Telemedicine  
The plan provides for virtual healthcare for common conditions and illnesses such as allergies, sinus, cold & flu, and bladder infection. Access to a doctor is available 24/7 by phone, mobile app or online portal.



	Governmental				Proprietary		Total
	General Fund	Special Revenue Fund	Debt Service Fund	Capital Projects Fund	Internal Service Fund	Enterprise Fund	
<b>Estimated Revenues (In flows)</b>	\$ 59,188,729	\$ 48,233,919	\$ 3,810,219	\$ 1,121,000	\$ 6,200,490	\$ 5,563,380	\$ 124,117,737
<b>Appropriations (Out flows)</b>	56,940,944	48,233,919	4,446,773	26,299,942	6,200,490	2,608,968	144,731,036
<b>Transfers Out</b>	5,449,088	-	-	-	-	4,054,412	9,503,500
<b>Total Appropriations and Other Uses (Out flows)</b>	62,390,032	48,233,919	4,446,773	26,299,942	6,200,490	6,663,380	154,234,536
<b>Appropriations (Out flows) from Fund Balance:</b>	(3,201,303)	-	(636,554)	(25,178,942)	-	(1,100,000)	(30,116,799)
<b>Projected Fund Balance Beg.</b>	21,121,494	-	2,168,871	52,118,592	1,344,067	1,500,000	78,253,024
<b>Projected Fund Balance End.</b>	\$ 17,920,191	\$ -	\$ 1,532,317	\$ 26,939,650	\$ 1,344,067	\$ 400,000	\$ 48,136,225

**Regular Board Meeting**

**9.B.**

**Meeting Date:** July 21, 2021  
**Title:** Approval of Redistribution of Fund Balance  
**Submitted For:** Jesus Amezcua, Business Office

**Submitted By:** Jaime Martinez  
**HCDE Goal(s):** 2. Deliver value responsibly  
4. Provide cost savings by leveraging tax dollars

**Recommended Action:** Approve

**Additional Resource Personnel:**

**Facilities/Technology Approval Needed?:** None

**Information**

**Posted Agenda Item:**

**Consider approval of estimated reserved fund balances for non-spendable, restricted, committed assigned and unassigned** under the Governmental Accounting Standards Board (GASB) 54. (This is an annual requirement to project our end of the year fund balance to meet GASB accounting standards. Once the audit is completed, the final fund balances will be reported at the January Board Meeting).

**Subject:**

**Estimated Fund Balance Reserves under GASB.**

**Rationale:**

Approval of the estimated General Fund balance categories for fiscal year ending August 31, 2021 in compliance with CE Local. The five classifications of the fund balance for the general fund include nonspendable, restricted, committed, assigned and unassigned fund balance. Final category amounts will be presented in the January 2021 board meeting once the Comprehensive Annual Financial Report (CAFR) has been audited.

**Fiscal Impact**

**Attachments**

Prejected Fund Balance

**Form Review**

**Inbox**

Assistant Superintendent - Business  
Assistant Superintendent - Business  
Form Started By: Jaime Martinez  
Final Approval Date: 07/07/2021

**Reviewed By**

Venetia Baldwin  
Jesus Amezcua

**Date**

07/06/2021 09:58 AM  
07/07/2021 11:41 AM  
Started On: 06/28/2021 01:26 PM

**HARRIS COUNTY DEPARTMENT OF EDUCATION  
GENERAL FUND**

**Estimated Fund Balance at August 31, 2021**



		Current FY 2019-2020 BALANCE 8/31	Recommended Redistribution	Adjusted FY 2020-21 BALANCE 8/31
<b>GASB #54</b>	<b><u>Non-Spendable Fund Balance</u></b>			
1990-34110000	Investment in Inventory	132,160	56,590	188,750
1990-34120000	Deferred Expenditures	45,083	(10,478)	34,605
	<b>Total Non-Spendable Fund Balance</b>	<b>177,243</b>	<b>46,112</b>	<b>223,355</b>
	<b><u>Committed Fund Balance</u></b>			
1990-35250003	Retirement Leave	500,000	(150,000)	350,000
1990-35250004	Unemployment Liability	200,000	0	200,000
1990-35250006	Capital Projects	1,314,976	0	1,314,976
	<b>Total Committed Fund Balance</b>	<b>2,014,976</b>	<b>(150,000)</b>	<b>1,864,976</b>
	<b><u>Assigned Fund Balance</u></b>			
1990-35450015	Bldg & Veh Replacement Acquisition	1,000,000	(1,000,000)	0
1990-35450016	Asset Replacement & Acquisition	1,700,000	(1,700,000)	0
1990-35450018	Local Construction	5,740,000	(5,740,000)	0
1990-35450013	QZAB Payment	691,129	0	691,129
1990-35450014	PFC Lease Payment	2,558,871	0	2,558,871
1990-35450022	Workforce Development	1,000,000	(650,000)	350,000
1990-35450023	Software and Program Development	850,000	0	850,000
1990-35450020	New Program Initiative	0	200,000	200,000
	<b>Total Assigned Fund Balance</b>	<b>13,540,000</b>	<b>(8,890,000)</b>	<b>4,650,000</b>
	<b>Total Other Reserves &amp; Inventory:</b>	<b>15,732,219</b>	<b>(8,993,888)</b>	<b>6,738,331</b>
1990-36110000	<b><u>Unassigned Fund Balance</u></b>	<b>17,106,875</b>	<b>319,909</b>	<b>17,426,784</b>
	<b>Grand Total General Fund:</b>	<b>32,839,094</b>	<b>(8,673,979)</b>	<b>24,165,115</b>



**Regular Board Meeting**

**9.C.**

**Meeting Date:** July 21, 2021  
**Title:** TASB Update 116/CH(Local)\_FirstR  
**Submitted For:** Danielle Bartz, Special Asst to Superintendent  
**Submitted By:** Winford Adams  
**Additional Resource Personnel:**

---

**Information**

**Posted Agenda Item:**

**Consider first reading of the following revised local policies:**

- a. CH(Local)
- b. CQB(Local)
- c. CV(Local)
- d. DCD(Local)
- e. DCE(Local)
- f. DEC (Local)
- g. FFAC(Local)
- h. GKA(Local)

**Subject:**

Consider first reading of the following revised local policies:

- a. CH(Local)
- b. CQB(Local)
- c. CV(Local)
- d. DCD(Local)
- e. DCE(Local)
- f. DEC(Local)
- g. FFAC(Local)
- h. GKA(Local)

**Rationale:**

Consider first reading of the following revised local policies:

- a. CH(Local)
  - b. CQB(Local)
  - c. CV(Local)
  - d. DCD(Local)
  - e. DCE(Local)
  - f. DEC(Local)
  - g. FFAC(Local)
  - h. GKA(Local)
- 

**Attachments**

- CH(LOCAL)
- CQB(LOCAL)
- GKA(LOCAL)
- DCD(LOCAL)
- DCE(LOCAL)
- CV(LOCAL)

This page  
intentionally  
left blank

This page  
intentionally  
left blank

This page  
intentionally  
left blank

This page  
intentionally  
left blank

This page  
intentionally  
left blank

This page  
intentionally  
left blank

This page  
intentionally  
left blank



This page  
intentionally  
left blank

This page  
intentionally  
left blank

This page  
intentionally  
left blank

This page  
intentionally  
left blank

This page  
intentionally  
left blank

This page  
intentionally  
left blank

This page  
intentionally  
left blank

This page  
intentionally  
left blank



This page  
intentionally  
left blank

This page  
intentionally  
left blank

This page  
intentionally  
left blank

This page  
intentionally  
left blank

This page  
intentionally  
left blank

This page  
intentionally  
left blank

This page  
intentionally  
left blank

This page  
intentionally  
left blank



This page  
intentionally  
left blank

This page  
intentionally  
left blank

This page  
intentionally  
left blank

This page  
intentionally  
left blank

This page  
intentionally  
left blank

This page  
intentionally  
left blank

This page  
intentionally  
left blank

This page  
intentionally  
left blank



This page  
intentionally  
left blank

This page  
intentionally  
left blank

**Regular Board Meeting**

**9.D.**

**Meeting Date:** July 21, 2021  
**Title:** Education Foundation of Harris County  
**Submitted For:** Kendra Jackson, Purchasing

**Submitted By:** Kendra Jackson  
**HCDE Goal(s):** 3. Advocate for learners through innovation

**Recommended Action:** Approve

**Additional Resource Personnel:** James Colbert, Dr. Jesus Amezcua

**Facilities/Technology Approval Needed?:**

**Information**

**Posted Agenda Item:**

**Consider approval of Memorandum of Understanding between HCDE and the Education Foundation of Harris County for the Partners in Education Project**, providing \$400,000 for grants, scholarships, and sponsorship activities (plus approximately \$35,000 in rollover funds form FY2021), and the Tools for Teachers Program, providing \$200,000 for educators' supplies, for a term of July 22, 2021 through August 31, 2022.

**Subject:**  
Education Foundation

**Rationale:**  
Consider approval of Memorandum of Understanding between HCDE and the Education Foundation of Harris County for the Partners in Education Project, providing \$400,000 for grants, scholarships, and sponsorship activities, and the Supply Our Schools Program, providing \$200,00 for educators' supplies, for a term of July 22, 2021 through August 31, 2022

**Fiscal Impact**

**Attachments**

*No file(s) attached.*

**Form Review**

**Inbox**  
Purchasing  
Purchasing  
Assistant Superintendent - Business  
Form Started By: Kendra Jackson  
Final Approval Date: 07/09/2021

**Reviewed By**  
Kendra Jackson  
Kendra Jackson  
Jesus Amezcua

**Date**  
07/08/2021 08:24 AM  
07/08/2021 08:24 AM  
07/09/2021 03:54 PM  
Started On: 07/08/2021 08:22 AM

**Regular Board Meeting**

**9.E.**

**Meeting Date:** July 21, 2021

**Title:** Change Order - contract for renovations to the existing La Porte Head Start Campus

**Submitted For:** Venetia Peacock, Head Start

**Submitted By:** Sharon McBride

**Recommended Action:** Approve

**HCDE Goal(s):**  
1. Impact education/respond to evolving needs  
2. Deliver value responsibly  
4. Provide cost savings by leveraging tax dollars

**Additional Resource Personnel:** Venetia Peacock, Jesus Amezcua, James Colbert

**Facilities/Technology Approval Needed?:**

**Information**

**Posted Agenda Item:**

**Consider the approval for Change Order #2 in the amount of \$4,384.53 to the Nash Industries contract for renovations to the existing La Porte Head Start Campus.** (Funds to be used from Head Start budget are \$3,189.73 and the remaining \$1,194.80 will be deducted from the architect’s fee.)

**Subject:**

**Change Order #2 in the amount of \$4,384.53 to the Nash Industries contract for renovations to the existing LaPorte Head Start Campus.**

**Rationale:**

**Change Order #2 will allow the furnishing and installation of a GFCI receptacle for an ADA drinking fountain as well as installation of conduits on the wall for 7 fire alarm pull stations.**

**Fiscal Impact**

**Attachments**

- Nash Industries CO2
- Nash Industries CO2 Memo
- Nash Industries PCO3
- Nash Industries PCO4

**Form Review**

**Inbox**

Head Start  
Purchasing  
Assistant Superintendent - Business  
Assistant Superintendent - Business  
Form Started By: Sharon McBride  
Final Approval Date: 07/07/2021

**Reviewed By**

Venetia Peacock  
Kendra Jackson  
Venetia Baldwin  
Jesus Amezcua

**Date**

06/28/2021 04:07 PM  
06/30/2021 09:10 AM  
07/06/2021 09:58 AM  
07/07/2021 11:41 AM  
Started On: 06/28/2021 11:28 AM



# Memorandum

---

To: Business Services Division

From: Joe Carreon Construction Director/Facilities Division

Date: June 26, 2021

Subject: LaPorte Early Head Start Expansion Project: Change Order No. 2

The dedicated GFCI Circuit for the new Drinking Fountain was inadvertently omitted from the plans by the Swart Architects. Per article 2.2 in Swart Architect's AIA B101 Contract, "the architect shall be responsible to the Owner all costs and damages resulting from errors and omissions of the architect". This portion of the change order (\$1,194.80) will be deducted from the architect's fee.

The fire alarm pull stations conduits were determined to be missing after the mold remediation. These locations were concealed behind the contaminated drywall and the contractor was unaware of their condition. There was no way for the contractor to have known the conduits were missing prior to removing the drywall. Fire Code requires a conduit and back box for all Fire Alarm Pull Stations. This cost will be paid for with Head Start funds.

Thank You,



Joe Carreon  
Construction Director  
Facilities Division



Nash Industries Inc  
6610 Supply Row  
Houston, Texas 77011  
Phone: (281) 829-4815  
Fax: (281) 783-2458

Project: P2101153 - La Porte Head Start  
927 S 1st  
La Porte , Texas 77571

### Prime Contract Potential Change Order #003: GFCI for ADA Drinking Fountain

<b>TO:</b>	HCDE 6300 Irvington Boulevard Houston, Texas 77022	<b>FROM:</b>	Nash Industries, Inc. 6610 Supply Row Houston, Texas 77011
<b>PCO NUMBER/REVISION:</b>	003 / 0	<b>CONTRACT:</b>	P2101153 - La Porte Head Start Prime Contract
<b>REQUEST RECEIVED FROM:</b>		<b>CREATED BY:</b>	Billie Rea (Nash Industries, Inc.)
<b>STATUS:</b>	Pending - In Review	<b>CREATED DATE:</b>	6/3/2021
<b>REFERENCE:</b>		<b>PRIME CONTRACT CHANGE ORDER:</b>	None
<b>FIELD CHANGE:</b>	No		
<b>LOCATION:</b>		<b>ACCOUNTING METHOD:</b>	Amount Based
<b>SCHEDULE IMPACT:</b>		<b>PAID IN FULL:</b>	No
<b>EXECUTED:</b>	No	<b>SIGNED CHANGE ORDER RECEIVED DATE:</b>	
		<b>TOTAL AMOUNT:</b>	\$1,194.80

POTENTIAL CHANGE ORDER TITLE: GFCI for ADA Drinking Fountain

CHANGE REASON: Existing Condition

POTENTIAL CHANGE ORDER DESCRIPTION: (The Contract Is Changed As Follows)

Furnish and install GFCI receptacle for ADA Drinking Fountain.  
(1) Dedicated 120v 20 amps, 85 ft approx. 293 ft #12 wire, (1) 20 amp breaker.

RS Means Total \$1,665.01 Total with (.80) Coefficient: \$1,332.01 Total with additional discount: \$1,194.80

Labor:\$477.92 Material:\$716.88

ATTACHMENTS:

- [Elkay cut sheet 2.jpg](#) , [\\_PCO 3 Breakdown Template.xlsx](#) , [\\_Elkay Cut Sheet.jpg](#) , [\\_CPR 01.pdf](#) , [\\_CPR 01 HS E4.0 ELECTRICAL SCHEDULES-E4.0.pdf](#) , [\\_La Porte Head Start GFCI Rec addition.pdf](#) , [\\_CPR 01 HS E2.0 ELECTRICAL POWER PLAN 6-4-21.pdf](#)

HCDE  
6300 Irvington Boulevard  
Houston, Texas 77022

Nash Industries, Inc.  
6610 Supply Row  
Houston, Texas 77011

\_\_\_\_\_  
SIGNATURE DATE

\_\_\_\_\_  
SIGNATURE DATE

*Kris Pittman* 06/18/2021  
\_\_\_\_\_  
SIGNATURE DATE

HCDE - La Porte Head Start



CPR #\_\_;  
AEA# \_\_

CCD #\_\_

ASI #\_\_;  
Clarification #\_\_ RFI #\_10

PCO #3

Description	Subcontracted	Self Performed	Mark Up %	Mark Up Total	Line Total
<b>Change Order Request # 3</b>					
Furnish and Install GFCI receptacle for ADA drinking Fountain.	\$ 999.00		15.00%	\$ 149.85	\$ 1,148.85
(1) Dedicated 120v 20 amps, 85 ft approx. 293 ft #12 wire, (1) 20 amp breaker.					
<b>Line Item Sub Totals</b>	<b>\$ 999.00</b>	<b>\$ -</b>		<b>\$ 149.85</b>	<b>\$ 1,148.85</b>
<i>Sub Total</i>					<b>\$ 1,148.85</b>
<i>Bond &amp; Insurance Increase Passthrough I</i>				<i>4.00%</i>	<i>\$ 45.95</i>
<b>PCO Total Amount</b>					<b>\$ 1,194.80</b>





**Jimtex Electric LLC**  
**11215 Jones Rd West Suite H**  
**Houston Tx 77065**  
**(832)875-6407**  
**HUB #1843388693600**

May 28, 2021

ATTN: Billie Rea - Nash Industries

Project : La Porte HS Rec. GFCI Addition

JIMTEX Electric Thanks you for the opportunity to bid on the above project, our price is:

\*\*\*\*\* \$ 999.00\*\*\*\*

\*\*\* \$ Nine Hundred Ninety Nine-Plus Tax\*\*\*

Included in this proposal is : Furnish and install GFCI receptacle for drinking fountain, 1) dedicated 120 v 20 amps, 85 ft approx. , 293 ft # 12 wire, 1) 20 amps breaker,

Labor \$ 528.24    Material \$ 380.0    O/P \$ 90.82    Total \$ 999.00

Work be performed during normal time 7:00am to 4:30pm

Exclusions: Code Upgrading on existing electrical installation, Egress light not specified (Generic Frog eye), Controls, fire alarm, telephone, data, security, IT or any other low voltage wiring or devices, Drywall repair, concrete work, patching or painting, Low voltage wiring lift or install support for it,

Our bid is valid for a period of 30 days, payment for this work will be expected within 30 days after completion of this project.

Sincerely,

*Emmanuel Manny Mares*

Emmanuel mares / estimating

# Change Proposal Request

**Swart Architects**

2855 Mangum Suite 566  
Houston, Texas 77092  
Tel 713.823.1660  
swart@sbcglobal.net.com

**Project:** Renovations for LA Porte Head Start  
Harris County Department of Education

**Request No.: 01**

**Project No.:** 0734

**Date:** June 7, 2021

---

**To:** Nash Industries  
6610 Supply Row  
Houston, Texas 77011

**Attention:** Francois Harvey

---

This is a request for an itemized quotation in the Contract Sum and/or time for the following proposed modifications to the Contract Documents.

This request is not an authorization for changes or additional work and it does not revise the Contract Price.

---

## Description of Work:

1. Add an electrical outlet for new drinking fountains

**Attachments: Revised sheets E2.0 and E4.0**

This Change Proposal was initiated at the request of the:				
Owner	<input checked="" type="checkbox"/> Architect	<input type="checkbox"/> Engineer	<input type="checkbox"/> Contractor	<input type="checkbox"/> City (TAS Review)

Swart Architects

**Copies to:** File  
Owner

**SCOPE OF ELECTRICAL WORK:**

1. PROVIDE AND INSTALL NEW RECEPTACLES IN NEW WALLS.
2. PROVIDE NEW WASHER AND DRYER CONNECTION PER DETAIL BELOW.
3. PROVIDE ELECTRICAL CONNECTIONS FOR (4) NEW SPLIT HVAC SYSTEMS AND (6) WALL MOUNTED HVAC UNITS. (RE-USE ALL EXISTING CIRCUITS) EXISTING HVAC UNITS NOT SHOWN FOR CLARITY.
4. PROVIDE NEW EXTERIOR (BATTERY) EMERGENCY EGRESS LIGHTS AS REQUIRED BY CURRENT CODES.

**ELECTRICAL NOTES:**

1. CEILING GRID NOT SHOWN FOR CIRCUIT CLARITY. FOR EXACT LOCATION OF CEILING GRIDS, REFER TO ARCHITECTURAL PLANS.
2. COORDINATE ALL HVAC SUPPLY AND RETURN REGISTER LOCATIONS WITH MECHANICAL DRAWINGS. LIGHT AND OR HVAC DIFFUSER LOCATIONS SHOWN TO BE MODIFIED AS REQUIRED TO ACCOMMODATE HVAC DROPS.
3. ELECTRICAL PANEL TO BE MARKED FOR ARC FLASH HAZARD PER NEC 110.16.
4. FAULT CURRENT SHOWN ON E3.0 IS BASED ON PHYSICAL TRANSFORMER CONFIGURATION. EC TO VERIFY EXACT AVAILABLE SHORT CIRCUIT CURRENT AND PROVIDE FOR FULLY RATED EQUIPMENT.
5. ALL WORK TO BE IN COMPLIANCE WITH NEC 2017.

**NOTES:**

1. LIGHT FIXTURES TO BE ATTACHED TO CEILING AND SERVED BY CONDUIT AND JUNCTION BOXES.
2. COORDINATE LIGHT FIXTURE LOCATIONS WITH MECHANICAL REQUIREMENTS. COORDINATE WITH OWNER/ARCHITECT.
3. SEE E5.0 FOR DETAILS REGARDING CONNECTION OF BATTERY BACK UP CIRCUITS. ALL BATTERY POWERED LIGHTS ARE TO BE CONNECTED TO NORMAL POWER CIRCUITS PER NEC 700.12(F). (SEE DETAILS)
4. EXACT LOCATIONS OF SWITCHES SHALL BE AS PER EXISTING OR AS DIRECTED BY THE OWNER.
5. ALL RECEPTACLES IN CLASSROOMS SHALL BE LOCATED NO LOWER THAN 48" AFF. THIS INCLUDES EXISTING AND NEW RECEPTACLES. ALL RECEPTACLES SHALL BE TAMPER-PROOF AND BE SPECIFICATION GRADE. (CROUSE-HINDS AR-342 DR EQUAL).
6. ONLY NEW RECEPTACLES TO BE INSTALLED ARE SHOWN. COORDINATE EXACT LOCATIONS OF RECEPTACLE PLACEMENTS WITH OWNER'S REP. EXISTING RECEPTACLES IN ROOMS TO BE USED AS CLASSROOMS TO BE RELOCATED ARE TO BE COORDINATED WITH OWNER'S REP.
7. ELECTRICAL CONTRACTOR SHALL FIELD-VERIFY AVAILABILITY OF NEW RECEPTACLE CIRCUITS AND RELOCATE CIRCUITS AS NEEDED FOR A WELL-BALANCED SYSTEM.
8. RELOCATE/ADD RECEPTACLES AS REQUESTED BY OWNER'S REP AT NO EXTRA CHARGE.
9. DRYER VENT BOOSTER FAN SHALL BE CONNECTED TO RECEPTACLE OUTLET CIRCUIT LA-11.

MARK	DESCRIPTION
⬤	FLUORESCENT FIXTURE
⬤	FLUORESCENT FIXTURE WITH BATTERY PACK
⊙	WALL BRACKET FIXTURE
⊙	FLUORESCENT FIXTURE
⊗	EXIT LIGHT
⊕	SINGLE RECEPTACLE
⊕	DUPLEX CONVENIENCE OUTLET
⊕	FLOOR MOUNTED DUPLEX OUTLET
⊕	240V OUTLET
⊕	OUTLET WITH GROUND FAULT CIRCUIT INTERRUPTER
⊕	RECEPTACLE WITH ISOLATED GROUND
⊕	QUAD PLEX CONVENIENCE OUTLET
⊕	WALL SWITCH
⊕	3-WAY SWITCH
⊕	SWITCH W/PILOT LIGHT
⊕	PASSIVE INFRARED WALL SWITCH/SENSOR W/MANUAL ON/OFF CONTROL
⊕	MOTOR RATED SWITCH
⊕	MOTOR
⊕	CIRCUIT HOME-RUN TO PANEL
⊕	SWITCH LEG
⊕	TELEPHONE OUTLET 1" TO ABOVE CEILING WITH WIRE TO TELEPHONE TERMINAL BOARD
⊕	DISCONNECT SWITCH
⊕	JUNCTION BOX
⊕	120V HARDWIRED CONNECTION
⊕	208V/1Ø HARDWIRED CONNECTION
⊕	MOTION DETECTOR, ARROW INDICATES DIRECTION
⊕	PHOTOCELL
⊕	208V/3Ø HARDWIRED CONNECTION
⊕	ELECTRICAL PANEL

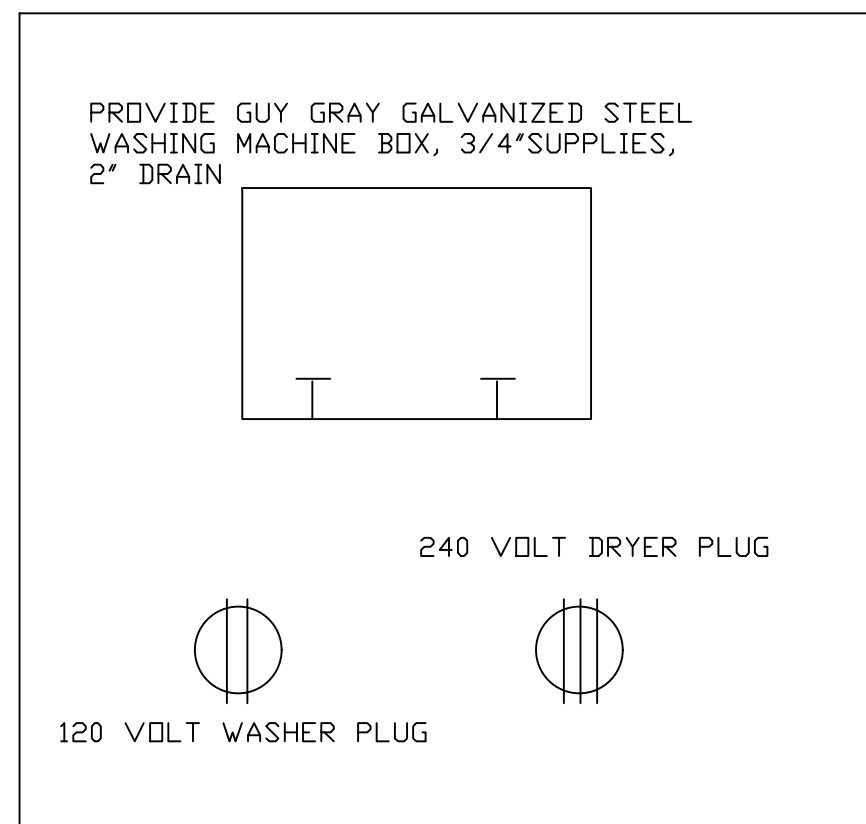
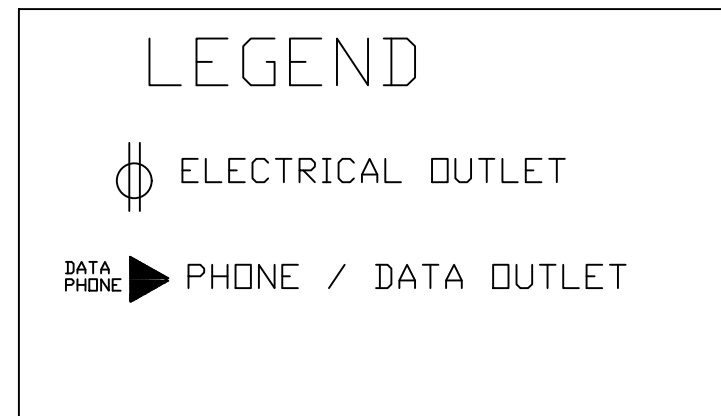

**WALL ELEVATION BEHIND WASHER**  
NTS

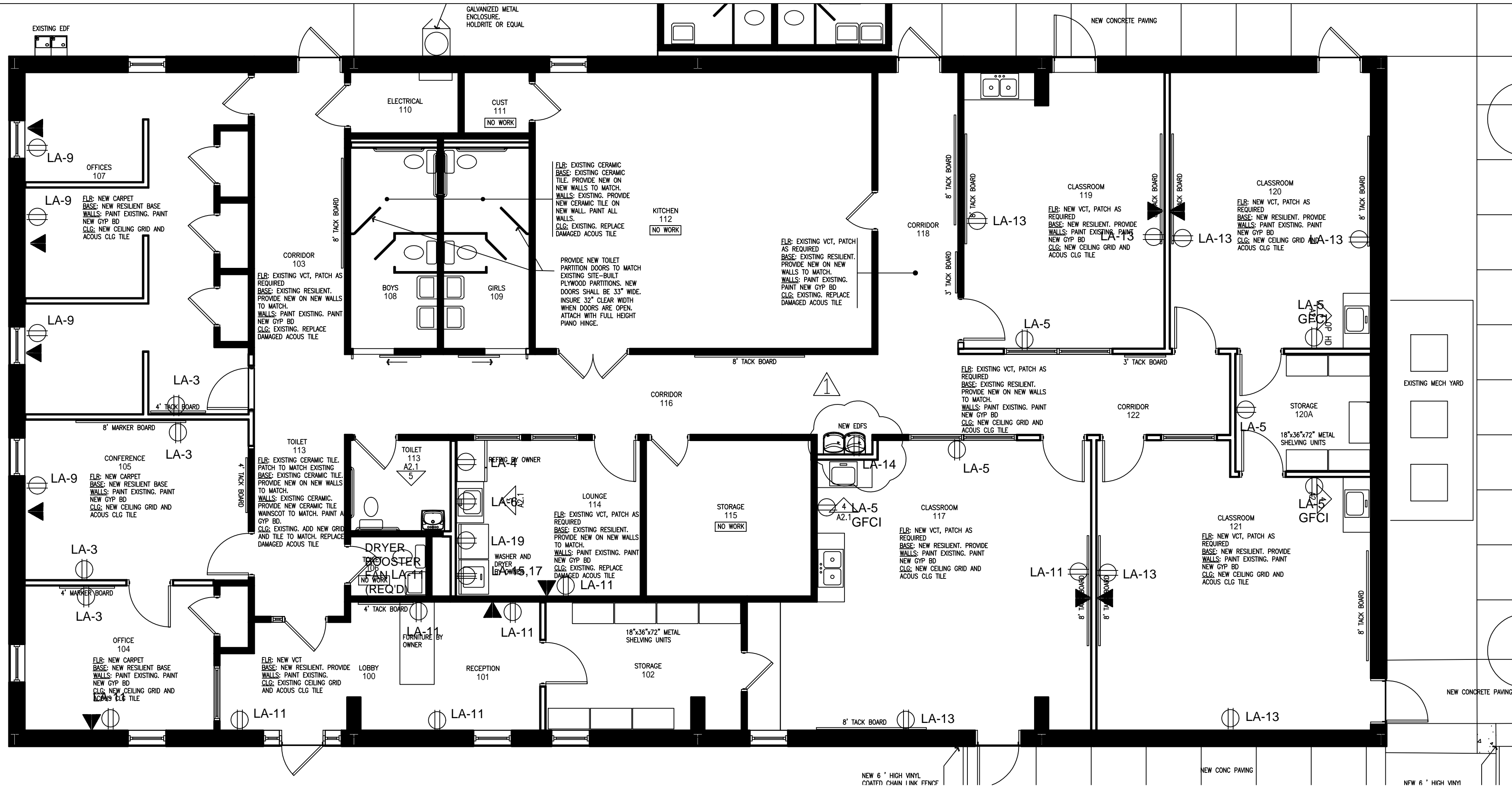

**ELECTRICAL POWER PLAN**

3/16" = 1'-0"

ISSUE DATES	
DATE	DESCRIPTION
09/14/2020	FOR PERMITTING
10/09/2020	REVISIONS
11/10/2020	REVISIONS
12/03/2020	CITY OF LA PORTE CMTS
01/08/2021	REVISIONS
06/04/2021	REVISIONS

**PROJECT TEAM**  
MEP ENGINEER: James E Thompson & Associates  
1169 County Road 136A  
Alvin, Texas 77511  
832.526.0160

STRUCTURAL ENGINEER  
CIVIL

This electronic drawing file is released under the authority of Swart Architects, Inc., who maintains the original file. This electronic drawing file may be used as a background drawing. Pursuant to Rule 1.102(f) of the Rules and Regulations of the Texas Board of Architectural Examiners, the user of this electronic drawing file agrees to assume all responsibility for any modification to or use of this drawing file that is inconsistent with the requirements of the Rules and Regulations of the Texas Board of Architectural Examiners. No person may make any modification to this electronic drawing file without the Architect's express written permission.

**Renovations to  
La Porte Head Start**  
Harris County Department of Education  
927 S 1st Street, La Porte, Texas 77571

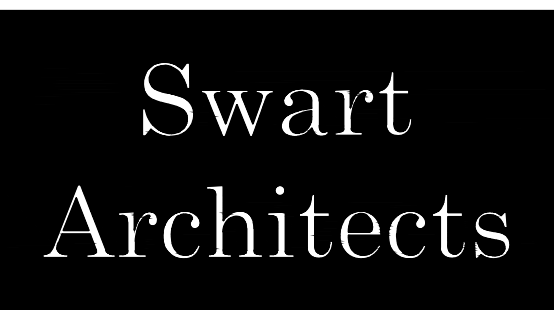

2855 Mangum  
Suite 505  
Houston, Texas 77092  
(713) 823-1660

SA PROJECT NO.:

**1916**

DATE:

**09/09/20**

SHEET TITLE: **ELECTRICAL POWER PLAN**

SHEET NO.:

**E2.0**

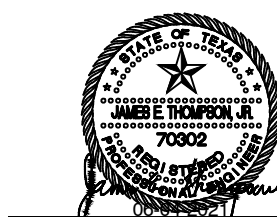

**JAMES E. THOMPSON & ASSOCIATES ENGINEERS**

First National Bank of Alvin Building  
1600 East Highway 6, Suite 331  
Alvin, Texas 77511  
T: (832)526-0160

- Mechanical • Electrical •
- Plumbing Design •
- Firm Registration #F1288

**ELECTRICAL LOAD ANALYSIS  
HEADSTART**

SERVICE VOLTAGE : 120/240V, 1 PHASE, 3 WIRE  
OCCUPANCY : OFFICES

LOAD DESCRIPTION	DIV. %	DESIGN LOAD KVA	REMARKS
1 LIGHTS			
OFFICE 4848 SF (3.0) 14.64	125%	18.3	
(b) CONNECTED INTERIOR LIGHTING LOAD	13.5	125%	2.33 design loads larger than connected
2 RECEPTACLES, 34	6.1	6.1	First 10KVA + 50% Remaining N.E.C. Article 220-13
3 COOLING LOADS	20.9	20.9	
4 HEATING LOADS (GAS)	0	0	COOL LOADS LARGER THAN HEAT
5 MOTORS	0	0	
6 EQUIPMENT (WATER HEATER) (GAS)	0	0	
7 KITCHEN	11.5	65%	7.5 N.E.C. Article 220-20
8 OUTSIDE LIGHTING ( BLDG MT)	1.0	125%	1.2
9 EXHAUST FANS	0	0	
10 25% LARGEST MOTOR 25% x Amp x0.480x1.732	0	0	

SUBTOTAL	N/A KVA	40.7 KVA	169.6 AMP.
PROPOSED SERVICE CAPACITY AT 120/240V		48 KVA.	200 AMP.
Provide service feeder from Power Company :	1 SET 2-3/0, 1-2/0 N		200 AMP
Ampacity of service feeder :			
SPARE CAPACITY AVAILABLE		7.3 KVA.	
PERCENT SPARE CAPACITY AVAILABLE		15.2 %	

PANEL 'La' (MODIFY) CU BUS					120/240V 1PH 3W SURFACE MOUNT NEMA 1 200A MCB 200A BUS NEUTRAL+GND BUS				
NO.	DESCRIPTION	LOAD	WIRE	DCP	NO.	DESCRIPTION	LOAD	WIRE	DCP
1	AC UNIT	6000	8	50	2	LIGHTS	500	12	20
3			8	2P	4	REFRIGERATOR	1000	12	20
5	RECEPTACLE	720	12	20	6	MICROWAVE	1000	12	20
7	RECEPTACLE	720	12	20	8			12	20
9	RECEPTACLE	720	12	20	10	OUTSIDE LTS	400	12	20
11	RECEPTACLE	720	12	20	12	MISC	700	12	20
13	RECEPTACLE	720	12	20	14	DRINKING FTN	1000	12	20
15	RANGE	4000	8	50	16			12	20
17			8	2P	18			12	20
19	WASHER	1500	12	20	20			12	20
21	DISH WASH	3000	8	40	22			12	20
23			8	2P	24			12	20
25			12	20	26			12	20
27			12	20	28			12	20
29	MGR OFFICE	1500	12	20	30			12	20
31			12	20	32			12	20
33			12	20	34			12	20
35			12	20	36	SPACE			
37	SPACE				38	SPACE			
39	SPACE				40	SPACE			
41	SPACE				42	SPACE			

19600 4600  
AMPACITY REQ'D=24200/240 X 1.25= 16.0 AMPS  
VERIFY ALL BREAKER AND WIRE SIZES WITH INSTALLATION MANUALS

**ELECTRICAL SCHEDULE**  
SCALE = NTS

ISSUE DATES	
DATE	DESCRIPTION
09/14/2020	FOR PERMITTING
10/09/2020	REVISIONS
11/16/2020	REVISIONS
12/03/2020	CITY OF LA PORTE CMTS
01/08/2021	REVISIONS
06/04/2021	REVISIONS

**PROJECT TEAM**  
MEP ENGINEER: James E Thompson & Associates  
1169 County Road 136A  
Alvin, Texas 77511  
832.526.0160  
STRUCTURAL ENGINEER:

This electronic drawing file is released under the authority of Swart Architects, Inc., who maintains the original file. This electronic drawing file may be used as a background drawing. Pursuant to Rule 1.102(f) of the Rules and Regulations of the Texas Board of Architectural Examiners, the user of this electronic drawing file agrees to assume all responsibility for any modification to or use of this drawing file that is inconsistent with the requirements of the Rules and Regulations of the Texas Board of Architectural Examiners. No person may make any modification to this electronic drawing file without the Architect's express written permission.

**Renovations to  
La Porte Head Start**  
Harris County Department of Education  
927 S 1st Street, La Porte, Texas 77571

**Swart  
Architects**

2855 Mangum  
Suite 505  
Houston, Texas 77092  
(713) 823-1660



**JAMES E.  
THOMPSON &  
ASSOCIATES  
ENGINEERS**  
First National Bank of Alvin Building  
1600 East Highway 6, Suite 331  
Alvin, Texas 77511  
T: (832) 526-0160  
•Mechanical •Electrical •  
•Plumbing Design  
•Firm Registration #F1288

SA PROJECT NO.:  
**1916**  
DATE:  
**09/09/20**  
SHEET TITLE: ELECTRICAL SCHEDULES  
SHEET NO.: **E4.0**

## Cost Estimate Report

Date: 06/18/2021

**HCDE**

927 S 1st  
La Porte, Texas, 77571

**La Porte Head Start PCO 3**

Year 2021 Quarter 2  
Unit Detail Report with Subcontracted Lines  
Prepared By: Kris Pittman

Nash Industries Inc

Line Number	Description	Quantity	Unit	Total Incl.O&P	Ext. Total Incl .O&P	Ext. Total Incl. O&P (Sub-Contracted)
<b>01 General Requirements</b>						
013114200120	Lock out hasp for multiple lockout tags	1.00	Ea.	\$9.02	9.02	0.00
<b>01 General Requirements Subtotal</b>					<b>9.02</b>	<b>0.00</b>
<b>26 Electrical</b>						
260519350045	Wire connector, screw type, insulated, #12 to #6	6.00	Ea.	\$3.35	20.10	0.00
260519901200	Wire, copper, stranded, 600 volt, #12, type THWN-THHN, normal installation conditions in wireway, conduit, cable tray	3.00	C.L.F.	\$66.09	198.27	0.00
260529202700	Threaded rod, steel, painted, 1/2" diameter	10.00	L.F.	\$12.85	128.50	0.00
260529203100	Nuts, galvanized steel, 1/2" diameter	0.20	C	\$46.28	9.26	0.00
260529203350	Washers, galvanized steel, 1/2" diameter	0.20	C	\$26.66	5.33	0.00
260529204114	Hangers, trapeze channel support, steel, 12" wide, steel, 12 Ga	8.00	Ea.	\$98.18	785.44	0.00
260529206650	Strap, steel channel, EMT, 3/4" diameter	3.00	Ea.	\$2.01	6.03	0.00
260533135220	Electric metallic tubing (EMT), field bends, 45 Deg. to 90 Deg., 3/4" diameter	2.00	Ea.	\$6.38	12.76	0.00
260533135340	EMT offsets, 3/4" diameter, to 15' H	1.00	Ea.	\$8.24	8.24	0.00
260533136220	EMT couplings, set screw, steel, 3/4" diameter, to 15' H	8.00	Ea.	\$3.54	28.32	0.00
260533136520	EMT boxes connectors, set screw, steel, 3/4" diameter, to 15' H	2.00	Ea.	\$5.79	11.58	0.00
260533140220	Electric metallic tubing, 3/4" diameter, to 10' high, includes 11 couplings per 100'	85.00	L.F.	\$2.86	243.10	0.00
260533160250	Outlet boxes, pressed steel, covers, blank, 4" square	1.00	Ea.	\$9.06	9.06	0.00

Line Number	Description	Quantity	Unit	Total Incl.O&P	Ext. Total Incl .O&P	Ext. Total Incl. O&P (Sub-Contracted)
260533160370	Outlet boxes, pressed steel, 4-11/16" square, 2-1/8" deep, 3/4" to 1-1/4" KO	2.00	Ea.	\$31.02	62.04	0.00
260533160400	Outlet boxes, pressed steel, extension rings, 4-11/16" square, 2-1/8" deep	1.00	Ea.	\$18.26	18.26	0.00
260533953040	Knockouts, metal boxes & enclosures, with hole saw, 3/4" pipe size, to 8' high	2.00	Ea.	\$10.84	21.68	0.00
262726202482	Duplex receptacle, ground fault interrupting, 20 amp	1.00	Ea.	\$80.25	80.25	0.00
262726204920	Receptacle cover plate, stainless steel, NEMA 5 & 6	1.00	Ea.	\$7.77	7.77	0.00
<b>26 Electrical Subtotal</b>					<b>1,655.99</b>	<b>0.00</b>
<hr/>						
<b>Subtotal</b>					<b>1,665.01</b>	<b>0.00</b>
<b>General Contractor's Markup on Subs</b>				<b>0.00%</b>		<b>\$0.00</b>
<hr/>						
<b>Subtotal</b>					<b>\$1,665.01</b>	<b>\$0.00</b>
<b>General Conditions</b>				<b>0.00%</b>	<b>\$0.00</b>	<b>\$0.00</b>
<hr/>						
<b>Subtotal</b>					<b>\$1,665.01</b>	<b>\$0.00</b>
<b>General Contractor's Overhead and Profit</b>				<b>0.00%</b>	<b>\$0.00</b>	<b>\$0.00</b>
<hr/>						
<b>Subtotal</b>					<b>\$1,665.01</b>	<b>\$0.00</b>
<hr/>						
<b>Grand Total</b>						<b>\$1,665.01</b>



Nash Industries Inc  
6610 Supply Row  
Houston, Texas 77011  
Phone: (281) 829-4815  
Fax: (281) 783-2458

Project: P2101153 - La Porte Head Start  
927 S 1st  
La Porte , Texas 77571

### Prime Contract Potential Change Order #004: Conduits for Fire Alarm Pull Stations (7)

<b>TO:</b>	HCDE 6300 Irvington Boulevard Houston, Texas 77022	<b>FROM:</b>	Nash Industries, Inc. 6610 Supply Row Houston, Texas 77011
<b>PCO NUMBER/REVISION:</b>	004 / 0	<b>CONTRACT:</b>	P2101153 - La Porte Head Start Prime Contract
<b>REQUEST RECEIVED FROM:</b>		<b>CREATED BY:</b>	Billie Rea (Nash Industries, Inc.)
<b>STATUS:</b>	Pending - In Review	<b>CREATED DATE:</b>	6/17/2021
<b>REFERENCE:</b>		<b>PRIME CONTRACT CHANGE ORDER:</b>	None
<b>FIELD CHANGE:</b>	No		
<b>LOCATION:</b>		<b>ACCOUNTING METHOD:</b>	Amount Based
<b>SCHEDULE IMPACT:</b>		<b>PAID IN FULL:</b>	No
<b>EXECUTED:</b>	No	<b>SIGNED CHANGE ORDER RECEIVED DATE:</b>	
		<b>TOTAL AMOUNT:</b>	\$3,189.73

POTENTIAL CHANGE ORDER TITLE: Conduits for Fire Alarm Pull Stations (7)

CHANGE REASON: Design Development

POTENTIAL CHANGE ORDER DESCRIPTION: (The Contract Is Changed As Follows)

Conduit on the walls for 7 Pull stations.

RS Means Total \$3,823.97 Total with (.80) Coefficient: \$3,059.17 Total with additional discount: \$3,189.73

Labor:\$1,275.90 Material:\$1,913.83

ATTACHMENTS:

- [Proposal La Porte Fire alarm Breakdown last update.pdf](#) , [\\_HCDE Head Start FA.pdf](#) , [\\_PCO 4 Breakdown Template.xlsx](#)

HCDE  
6300 Irvington Boulevard  
Houston, Texas 77022

Nash Industries, Inc.  
6610 Supply Row  
Houston, Texas 77011

\_\_\_\_\_  
SIGNATURE DATE

\_\_\_\_\_  
SIGNATURE DATE

*Kris Pittman* 06/18/2021  
\_\_\_\_\_  
SIGNATURE DATE

HCDE - La Porte Head Start



CPR #\_\_;

ASI #\_\_;

AEA# \_\_\_

CCD #\_\_\_

Clarification #\_\_\_ RFI #\_10

PCO #4

Description	Subcontracted	Self Performed	Mark Up %	Mark Up Total	Line Total
Change Order Request # 4					
Conduits ran for (7) Fire Alarm Pull Stations	\$ 2,667.00		15.00%	\$ 400.05	\$ 3,067.05
<b>Line Item Sub Totals</b>	<b>\$ 2,667.00</b>	<b>\$ -</b>		<b>\$ 400.05</b>	<b>\$ 3,067.05</b>
<i>Sub Total</i>					<b>\$ 3,067.05</b>
<i>Bond &amp; Insurance Increase Passthrough I</i>				<i>4.00%</i>	<b>\$ 122.68</b>
<b>PCO Total Amount</b>					<b>\$ 3,189.73</b>





**Jimtex Electric LLC**  
**11215 Jones Rd West Suite H**  
**Houston Tx 77065**  
**(832)875-6407**  
**HUB #1843388693600**

June 16, 2021

ATTN: Billie Rea – Nash Industries Inc.

Project: La Porte Fire alarm

JIMTEX Electric Thanks you for the opportunity to bid on the above project, our price is:

Breakdown

Labor \$1,097.36            Material \$1,327.18            OHP 10% \$242.46

Total

\*\*\*\*\* \$ 2,667.00\*\*\*

\*\*\* \$ Two Thousand Six Hundred Sixty-Seven Plus Tax\*\*\*

Included in this proposal is: Conduit on the walls for 7 Pull stations and conduit running through both buildings requesting by Justin base plans provided by Justin Jacob.

Work be performed during normal time 7:00am to 4:30pm

Exclusions: Controls, fire alarm, telephone, data, security, camera, IT or any other low voltage wiring or devices, Drywall repair, concrete work, patching or painting, any upgrade to existing electrical installation, any ceiling roofing.

Our bid is valid for a period of 30 days, payment for this work will be expected within 30 days after completion of this project.

Sincerely,

*Mauricio Reyes*

Mauricio Reyes / estimating

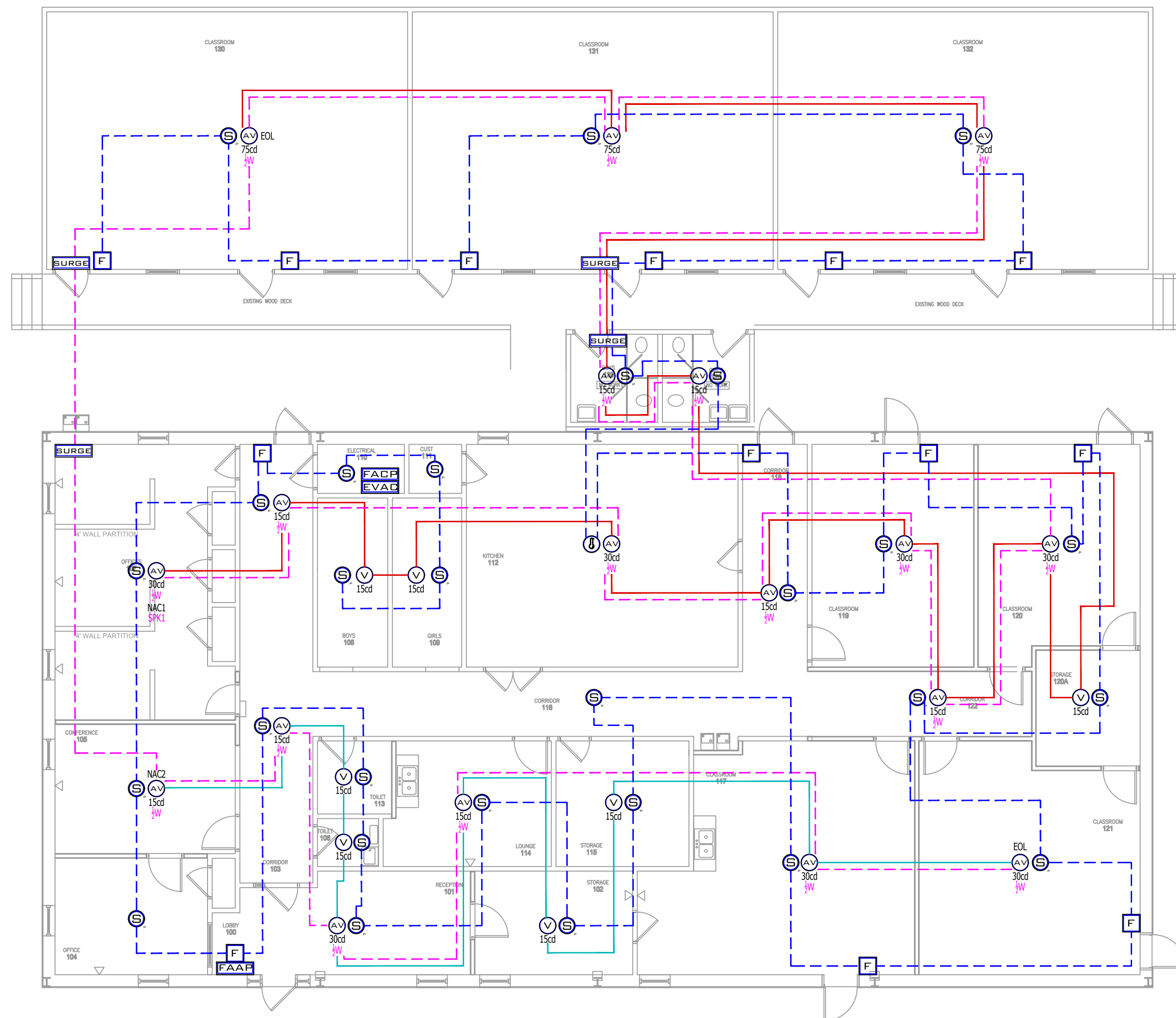

FOR SUBMITTAL     RECORD DRAWINGS  
 I HAVE REVIEWED THESE PLANS AND CERTIFY THAT THEY COMPLY WITH THE APPLICABLE CODES AND STANDARDS;  
 OR  
 CERTIFY THEY WERE COPIED FROM SEALED ENGINEERING PLANS AND ANY VIOLATIONS OF THE APPLICABLE CODES OR STANDARDS ARE SPECIFICALLY NOTED ON THESE PLANS.  
 Quality Security Sys  
 220 Barren Springs Dr. Suite 4  
 Houston, TX 77090  
 281.820.9650    ACR-1425  
  
*[Signature]*    APS-1849330  
 APS LICENSEE SIGNATURE    LICENSE #  
 MUNOZ JR, HENRY    03/19/21  
 APS PRINTED NAME    DATE:

QTY	DEVICE DESCRIPTION
01	<b>FACP</b> - FIRE ALARM CONTROL PANEL
01	<b>EVAC</b> - VOICE EVACUATION PANEL
01	<b>FAAP</b> - ANNUNCIATOR AND REMOTE MIC
05	<b>SURGE</b> - SURGE PROTECTOR
01	<b>CELL</b> - CELL COMMUNICATOR

QTY	INITIATING DEVICE DESCRIPTION
28	<b>S</b> - PHOTO ELECTRIC SMOKE DETECTOR
13	<b>F</b> - PULL STATION
01	<b>H</b> - HEAT DETECTOR
00	<b>FS</b> - WATER FLOW SWITCH
00	<b>TS</b> - TAMPER SWITCH
00	<b>CD</b> - CARBON MONOXIDE DETECTOR
00	<b>DD</b> - DUCT DETECTOR
00	<b>MM</b> - ADDRESSABLE INPUT MODULE
00	<b>NM</b> - NOTIFICATION MODULE
00	<b>RM</b> - RELAY MODULE
00	<b>DM</b> - DUAL INPUT MONITORING MODULE

QTY	NOTIFICATION DEVICE DESCRIPTION
18	<b>AV</b> - CEILING MOUNTED SPEAKER/STROBE
07	<b>V</b> - CEILING MOUNTED STROBE
00	<b>AV</b> - WALL MOUNTED SPEAKER/STROBE
00	<b>V</b> - WALL MOUNTED STROBE
00	<b>AVWP</b> - WALL MOUNTED HORN/STROBE (WEATHERPROOF)
00	<b>B</b> - FIRE ALARM BELL
00	<b>DH</b> - DOOR HOLDER
00	<b>L</b> - LOW FREQUENCY HORN
00	<b>SB</b> - PHOTO ELECTRIC SMOKE DETECTOR W/ SOUNDER BASE (LOW FREQUENCY)
00	<b>AVLF</b> - WALL MOUNTED HORN/STROBE (LOW FREQUENCY)
00	<b>AVLF</b> - CEILING MOUNTED HORN/STROBE (LOW FREQUENCY)

TEXT



REVISIONS:

PROJECT NAME:	HODE HEAD START LA PORTE
PROJECT ADDRESS:	927 S 1ST ST. LA PORTE, TX 77571
SYSTEM TYPE:	FIRE ALARM
DRAWN BY:	CY
DATE ISSUED:	03/19/2021
SHEET NUMBER:	1 of 1
REVISION:	0

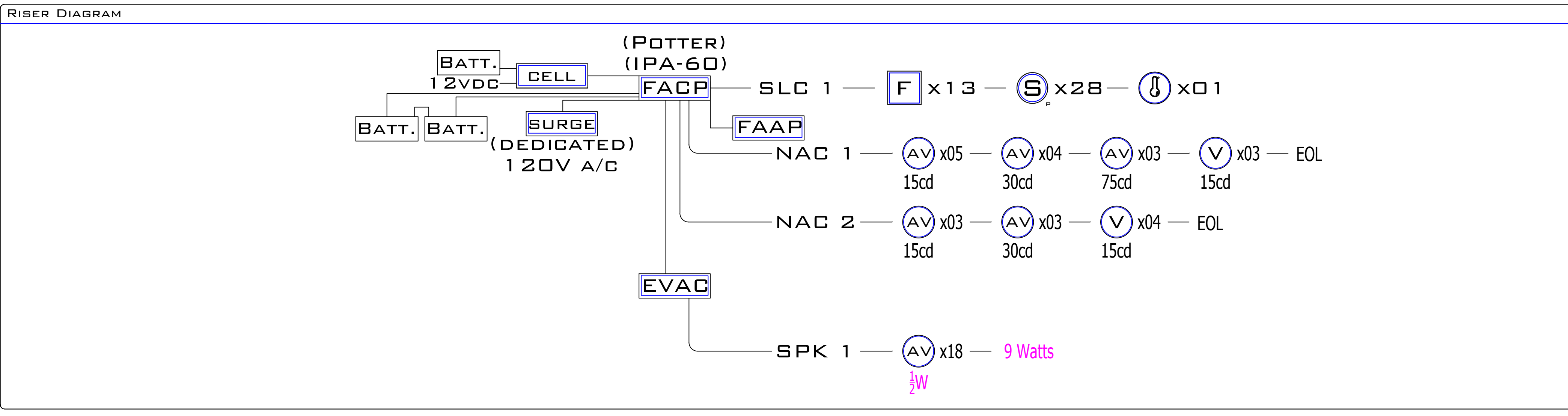

FIRE ALARM SYSTEM OUTPUTS	
PANEL INDICATION	NOTIFICATION
ALARM LED LIGHT AT PANEL	ALARM BELL
SUPERVISORY LED LIGHT AT PANEL	ALARM BELL
REPELIBLE LED LIGHT AT PANEL	ALARM BELL
AUDIBLE ANNUNCIATOR BIRMS TO SOUND AT PANEL	ALARM BELL
AUDIBLE ANNUNCIATOR BIRMS TO SOUND AT ANNUNCIATOR	ALARM BELL
MANUAL FIRE ALARM BIRMS TO MONITORING ENTITY	ALARM BELL
MANUAL FIRE ALARM BIRMS TO INDICATING ENTITY	ALARM BELL
TRANSMIT WATER FLOW ALARM SIGNAL TO INDICATING ENTITY	ALARM BELL
TRANSMIT WATER FLOW ALARM SIGNAL TO MONITORING ENTITY	ALARM BELL
PERMANENT PROBABLE SIGNAL TO MONITORING ENTITY	ALARM BELL
PERMANENT PROBABLE SIGNAL TO INDICATING ENTITY	ALARM BELL
ALL AUDIBLE & VISUAL ALARM ARE ACTIVATED	ALARM BELL
ALARM BIRMS TO ANY SHUTDOWN AFFECTED	ALARM BELL
ALARM BIRMS TO ANY SHUTDOWN AFFECTED	ALARM BELL

INPUT OUTPUT MATRIX	
ALARM INDICATION	NOTIFICATION
A	MANUAL PULL STATION
B	SMOKE DETECTOR
C	HEAT DETECTOR
D	
E	
F	
G	
H	
I	
J	
K	
L	
M	FIRE ALARM AC POWER FAILURE
N	FIRE ALARM SYSTEM LOW BATTERY
O	MISSING DEVICE
P	PHONE LINE TROUBLE
Q	OPEN CIRCUIT
R	GROUND FAULT
S	SHORT CIRCUIT
T	
U	
V	
W	
X	
Y	
Z	



THE INFORMATION CONTAINED  
 HEREIN IS THE PROPERTY OF  
 QUALITY SECURITY SYSTEMS, INC.  
 AND IS NOT TO BE REPRODUCED,  
 COPIED, OR DISCLOSED TO OTHERS  
 WITHOUT THE WRITTEN PERMISSION  
 OF QUALITY SECURITY SYSTEMS, INC.  
 THIS DOCUMENT IS UNCLASSIFIED  
 EXCEPT AS AUTHORIZED BY  
 CONTRACT OR WITH WRITTEN  
 PERMISSION OF Quality  
 Security.

## Cost Estimate Report

Date: 06/18/2021

**HCDE**

927 S 1st  
La Porte, Texas, 77571

**La Porte Head Start PCO 4**

Year 2021 Quarter 2  
Unit Detail Report with Subcontracted Lines  
Prepared By: Kris Pittman

Nash Industries Inc

Line Number	Description	Quantity	Unit	Total Incl.O&P	Ext. Total Incl .O&P	Ext. Total Incl. O&P (Sub-Contracted)
<b>26 Electrical</b>						
260529202700	Threaded rod, steel, painted, 1/2" diameter	20.00	L.F.	\$12.85	257.00	0.00
260529203100	Nuts, galvanized steel, 1/2" diameter	1.00	C	\$46.28	46.28	0.00
260529203350	Washers, galvanized steel, 1/2" diameter	1.00	C	\$26.66	26.66	0.00
260529204114	Hangers, trapeze channel support, steel, 12" wide, steel, 12 Ga	12.00	Ea.	\$98.18	1,178.16	0.00
260529206650	Strap, steel channel, EMT, 3/4" diameter	7.00	Ea.	\$2.01	14.07	0.00
260529209240	Conduit hanger, steel, adjustable, 3/4"	21.00	Ea.	\$23.19	486.99	0.00
260533135220	Electric metallic tubing (EMT), field bends, 45 Deg. to 90 Deg., 3/4" diameter	7.00	Ea.	\$6.38	44.66	0.00
260533136220	EMT couplings, set screw, steel, 3/4" diameter, to 15' H	7.00	Ea.	\$3.54	24.78	0.00
260533136520	EMT boxes connectors, set screw, steel, 3/4" diameter, to 15' H	7.00	Ea.	\$5.79	40.53	0.00
260533140220	Electric metallic tubing, 3/4" diameter, to 10' high, includes 11 couplings per 100'	200.00	L.F.	\$2.86	572.00	0.00
260533160370	Outlet boxes, pressed steel, 4-11/16" square, 2-1/8" deep, 3/4" to 1-1/4" KO	7.00	Ea.	\$31.02	217.14	0.00
260533160400	Outlet boxes, pressed steel, extension rings, 4-11/16" square, 2-1/8" deep	7.00	Ea.	\$18.26	127.82	0.00
260533254880	Conduit fittings for rigid galvanized steel, through-wall seal, 1-1/2" diameter	1.00	Ea.	\$570.00	570.00	0.00
260533953040	Knockouts, metal boxes & enclosures, with hole saw, 3/4" pipe size, to 8' high	7.00	Ea.	\$10.84	75.88	0.00
<b>26 Electrical Subtotal</b>					<b>3,681.97</b>	<b>0.00</b>

**33 Utilities**

Line Number	Description	Quantity	Unit	Total Incl.O&P	Ext. Total Incl .O&P	Ext. Total Incl. O&P (Sub-Contracted)
337119179960	Electrical underground ducts and manholes, nylon polyethylene pull rope, 1/4"	200.00	L.F.	\$0.71	142.00	0.00
<b>33 Utilities Subtotal</b>					<b>142.00</b>	<b>0.00</b>
<b>Subtotal</b>					<b>3,823.97</b>	<b>0.00</b>
<b>General Contractor's Markup on Subs</b>				<b>0.00%</b>		<b>\$0.00</b>
<b>Subtotal</b>					<b>\$3,823.97</b>	<b>\$0.00</b>
<b>General Conditions</b>				<b>0.00%</b>	<b>\$0.00</b>	<b>\$0.00</b>
<b>Subtotal</b>					<b>\$3,823.97</b>	<b>\$0.00</b>
<b>General Contractor's Overhead and Profit</b>				<b>0.00%</b>	<b>\$0.00</b>	<b>\$0.00</b>
<b>Subtotal</b>					<b>\$3,823.97</b>	<b>\$0.00</b>
<b>Grand Total</b>						<b>\$3,823.97</b>



**EARLY HEAD START CHILD CARE PARTNERSHIP AGREEMENT  
BETWEEN  
HARRIS COUNTY DEPARTMENT OF EDUCATION  
AND  
COMMUNITY PARTNERS EARLY CHILDHOOD DEVELOPMENT CENTER**

This Early Head Start Child Care Agreement (“Agreement”) is entered into by and between the Harris County Department of Education (“HCDE”), a political subdivision of the State of Texas, having its principal office and place of business at 6300 Irvington Blvd., Houston, Texas 77022 and Community Partners Early Childhood Development Center (“Provider”), having its principal office and place of business at 4901 Lockwood Dr., Houston, Texas 77026 HCDE and Provider shall be referred to collectively herein as the “Parties”.

**RECITALS**

**WHEREAS**, HCDE is a recipient of Early Head Start Child Care grant funds;

**WHEREAS**, Provider submitted a proposal in response to RFP #21/029IA, the procurement solicitation for Early Head Start Child Care services issued by HCDE;

**WHEREAS**, Provider’s proposal has been accepted and awarded by HCDE;

**WHEREAS**, HCDE and Provider desire to create a partnership to accomplish the shared objective of increasing access to quality comprehensive early childhood service for low-income families with infants and toddlers in east and northeast Harris County; and

**WHEREAS**, this Agreement sets forth the respective roles and responsibilities of Provider and HCDE in providing Early Head Start Child Care services for infants and toddlers (0-3 years old) in compliance with Early Head Start Child Care grant requirements and Head Start Performance Standards.

**NOW, THEREFORE**, in consideration of the mutual covenants and conditions contained in this Agreement and other good and valuable consideration, the receipt and sufficiency of which are hereby acknowledged, HCDE and Provider, intending to be legally bound, and subject to the terms, conditions, and provisions of this Agreement, agree as follows:

**ARTICLE 1: MUTUAL RESPONSIBILITIES OF THE PARTIES**

- 1. Confidentiality.** The Parties agree to secure the confidentiality of all information and records in accordance with applicable federal and state laws, rules, and regulations, including but not limited to, the Health Insurance Portability and Accountability Act (HIPAA) and the Family Educational Rights and Privacy Act (FERPA), as applicable, and HCDE’s confidentiality procedures. The Parties understand that HIPAA and FERPA govern the privacy and security of medical and educational records and information and agree to abide by HIPAA and FERPA rules and regulations, as applicable. Provider also acknowledges that HCDE is subject to the Texas Public Information Act, and Provider waives any claim against and releases from liability HCDE, its officers, employees, agents, and attorneys with respect to disclosure of information provided under or in this Agreement or otherwise created, assembled, maintained, or held by Provider and determined by HCDE, the Attorney General of Texas, or a court of law to be subject to disclosure under the Texas Public Information Act.

2. **Early Head Start Child Care Program.** The Parties agree to form an Early Head Start Child Care Partnership to provide Early Head Start Child Care (“EHS-CC”) services for up to 16 children ages 0-3 years old at Provider’s child care facility located at 4901 Lockwood Dr., Houston, Texas 77026 in compliance with EHS-CC program requirements established by the United States Department of Health and Human Service (“HHS”). The Parties shall mutually assure that the families of all the EHS-CC Partnership children served at Provider’s facility shall have access to the full range of EHS-CC services and shall be mutually responsible for assuring continuity in implementing EHS-CC services. The Parties shall work in collaboration to ensure all EHS compliance issues are addressed and met.
3. **Eligibility, Recruitment, Selection, Enrollment and Attendance.** The Parties will work together to ensure all children and families enrolled in the EHS-CC partnership are either income or categorically eligible for Early Head Start Services. The Parties will work together to identify partnership eligible families currently enrolled in Provider’s child care program. HCDE will refer partnership eligible families to Provider when appropriate.
4. **Medical Screenings.** HCDE and Provider shall coordinate to provide all required developmental, sensory, behavioral and medical screenings for EHS-CC children within required 45-day timeframe and shall make referrals for follow-up treatment services, as needed.
5. **Reporting.** HCDE and Provider will meet quarterly to review this partnership. Any compliance monitoring issues or professional development needs will be addressed at these meetings. Minutes will be recorded and kept on site at the administrative offices of HCDE and Provider. Any correction plans developed in these meetings will also be recorded and kept on-site, with updates and completion of correction plans recorded in meeting minutes.
6. **Special Services.** HCDE and Provider shall provide special services to children diagnosed with disabilities, including training on inclusion of these children in a full range of activities. HCDE and Provider shall participate in transition meetings and Child Find meetings for enrolled children.
7. **Special Programs and Projects.** HCDE and Provider shall collaborate to plan and provide parent activities including Parent, Family and Community Engagement meetings, programs and projects. HCDE and Provider shall also collaborate to establish community partnerships that will offer resources to children and families.

## ARTICLE II: RESPONSIBILITIES OF PROVIDER

1. **Administrative and Financial.** Provider will provide program management information to HCDE on at least a quarterly basis. Provider will timely inform HCDE of subsidy eligibility changes for enrolled partnership families.
2. **Compliance with Laws and EHS Program Requirements.** Provider shall comply with all EHS program requirements, Head Start Program Performance Standards (“HSPPS”), HHS Standards, and Texas Department of Family and Protective Services (“DFPS”) Minimum Standards, including but not limited to, all HCDE and EHS child attendance policies and procedures, all HCDE and EHS health and safety practices, and all DFPS Child Care Licensing regulations. Provider shall comply with all federal, state, and local laws, statutes, ordinances, rules, and regulations, including, if applicable, workers’ compensation laws, minimum and maximum salary and wage statutes and regulations, prompt payment and licensing laws and regulations. Provider agrees that the certifications and agreements included on the HCDE Vendor Certification Forms, attached hereto as Exhibit A and incorporated by reference in this Agreement for all purposes, are true and correct. For the entire duration of this Agreement, Provider shall maintain all required

licenses, certifications, permits, and any other documentation necessary to perform this Agreement, including a valid DFPS Child Care License. When required or requested by HCDE, Provider shall furnish HCDE with satisfactory proof of Provider's compliance with this provision.

3. **Compliance Monitoring.** Provider will participate in the compliance monitoring and improvement plan system established by HCDE and will allow access to HCDE, EHS, and/or HHS and their respective authorized representatives for classroom and staff observations as well as to all documentation relating to this Agreement.
4. **Criminal History Review.** Prior to commencing any work under this Agreement, Provider must certify that for each covered employee, volunteer or contractor of Provider who will have direct contact with students, Provider has obtained, as required by Texas Education Code Section 22.0834: (a) state criminal history record information from a law enforcement or criminal justice agency or a private entity that is a consumer reporting agency governed by the Fair Credit Reporting Act (15 U.S.C. Section 1681 et seq.) for each covered employee of Provider employed before January 1, 2008; and (b) national criminal history record information for each employee of Provider employed on or after January 1, 2008. Provider must also obtain similar certifications of compliance with Texas Education Code Chapter 22's requirements from any subcontractors. Covered employees with disqualifying criminal history are prohibited from serving at HCDE; Provider and any subcontracting entity may not permit a covered employee to provide services at a child care facility if the employee has been convicted of a felony or misdemeanor offense that would prevent a person from being employed under Tex. Educ. Code § 22.085(a) (i.e., Title 5 felony or an offense requiring registration as a sex offender and victim was under 18 years of age or was enrolled in a public school at the time the offense occurred).
5. **Curriculum and Child Assessment:** Provider will implement an evidence-based early childhood curriculum that is developmentally appropriate for infants and toddlers and conduct ongoing assessment(s) of children to individualize the instruction and learning for each child.
6. **Eligibility, Recruitment, Selection, Enrollment and Attendance.** Provider will provide HCDE with attendance reports by each Tuesday. Provider must promote regular attendance and partner with HCDE EHS to implement strategies to support a monthly average daily attendance rate of a minimum of 85% per student. Provider will work closely with enrolled families and HCDE to successfully complete subsidy applications and subsidy re-determinations. Provider shall comply with the plan developed by HCDE to deliver ongoing supplemental services to EHS children and families. Provider shall also comply with the disabilities service plan developed by HCDE for each EHS enrolled child with a disability.
7. **Facility and Equipment Requirements.** Provider shall provide a child care facility that serves children ages 0–3 years old. Classroom(s) at Provider's child care facility may have a maximum of eight children with a ratio of one teacher per four children, and classroom(s) must accommodate a minimum of 35 square feet per child, not including crib space. Provider's facility shall meet all Head Start Program Performance Standards, EHS Program Standards and all DFPS Child Care Licensing regulations, including requirements for facilities, square footage, health and safety, and appropriate crib and sleep spacing and arrangements. Provider's facility shall include secure space for confidential files to be kept locked on Provider's premises, and Provider shall ensure that all confidential files are kept locked in said secure space on Provider's premises. Provider shall maintain a working computer and email capability for the entire Term of this Agreement. Provider shall maintain and secure any property, including all equipment and materials, provided by HCDE, and all such property shall remain the sole property of HCDE. Provider agrees that upon termination or expiration of the Agreement, Provider shall return all HCDE property, including all equipment and materials provided by HCDE, to HCDE within thirty of days after the effective date of termination or expiration of this Agreement.



- 8. Full Day/Full Year Early Head Start Child Care.** Provider shall operate a full-day/full-year EHS program as defined by HCDE and EHS and shall provide comprehensive child development services to all EHS children in its care pursuant to this Agreement and in accordance with the specifications identified in the Early Head Start rules and regulations. Provider shall provide EHS CC services at least ten (10) hours per day and at least 48 weeks per year. Provider shall submit annual service calendars to HCDE annually by June 30<sup>th</sup> of each year during the Term to enable HCDE to verify that the required weeks of service are provided. Provider shall implement educational services in accordance with EHS and HCDE requirements.
- 9. Health and Nutrition.** Provider shall enroll in the United States Department of Agriculture’s Child and Adult Care Food Program (“CACFP”), maintain good standing within CACFP, and ensure that children receive two thirds of the required daily nutrition while participating in CACFP. Provider shall provide breakfast, lunch, and afternoon snack to all EHS children, and all meals and snacks served by Provider must meet EHS requirements.
- 10. Home Visits; Parent-Teacher Conferences.** Provider shall make, at a minimum, two home visits per year for each EHS child served by Provider pursuant to this Agreement. Provider shall hold two parent-teacher conferences per year with each EHS enrolled family or primary guardian. Provider shall maintain adequate documentation of said home visits and parent-teacher conferences.
- 11. Inspection.** Provider shall allow HCDE staff and its authorized representatives, at any time during normal business hours, with or without notice, to inspect Provider’s facilities; observe Provider’s performance; and observe, evaluate, screen, and interact with EHS children served by Provider pursuant to this Agreement.
- 12. Insurance.** Provider is required to maintain General Liability Insurance coverage in an amount of \$300,000 per occurrence for negligence and to provide HCDE with copies of certificates of insurance. Certificates of Insurance, name and address of Provider, the limits of liability, the effective dates of each policy, and policy number shall be delivered to HCDE prior to commencement of any work under this Agreement and updated certificates of insurance shall be submitted to HCDE annually. The insurance company insuring Provider shall be licensed in the State of Texas and shall be acceptable to HCDE. Provider shall give HCDE a minimum of ten (10) days’ notice prior to any modifications or cancellation of said policies of insurance. Provider shall require all subcontractors performing any work under or relating to this Agreement to maintain coverage as specified herein. Upon request, certified copies of original insurance policies shall be furnished to HCDE. HCDE reserves the right to require additional insurance should HCDE deem additional insurance necessary, in HCDE’s sole discretion.
- 13. Parent and Community Engagement.** Provider will work closely with HCDE to ensure EHS parents are engaged and included in the full range of child development and family support services that are available and appropriate for each family. This will include a parent advisory committee with representation from partnership parents as well as members of the community, as appropriate. Provider will engage parents and the community to obtain non-federal shares that are reasonable and necessary for the accomplishment of EHS program objectives.
- 14. Reporting and Recordkeeping.** For all EHS children served by Provider pursuant to this Agreement, Provider shall maintain up-to-date records of children’s attendance, menus, medical conditions (including appropriate consent forms) and all other items required by HCDE, HHS, DFPS Child Care Licensing, CACFP, and any governmental authority or applicable funding agency. Provider shall maintain daily performance and attendance reports, signature sheets and other documents required by HCDE and shall submit such reports to the HCDE Accounts Payable Department on a semi-monthly basis no later than the 1st and 5th business day after the due date. Provider shall maintain annual service calendars and shall submit such service calendars to HCDE annually by June 30<sup>th</sup> of each year during the Term to enable HCDE to verify that the required weeks of service are provided.

- 15. Solicitation of Parental Contributions Prohibited.** Provider shall not require or ask EHS parents to supply any items, including diapers, food, cash, and/or reimbursements for EHS children in Provider's care.
- 16. Teaching Staff Credentials; Teacher-Child Ratio; Group Size.** Provider shall hire and employ qualified teachers and ensure all teaching staff attend all classes and complete all requirements necessary to obtain a Child Development Associate ("CDA") credential for Infant and Toddler Caregivers within twelve months from beginning services. The Lead Teacher in each EHS partnership classroom must have a currently active CDA credential for Infant and Toddler Caregivers or an equivalent credential that addresses comparable competencies. Provider shall maintain a teacher-child ratio of one teacher for every four children. No more than eight children will be placed in any one classroom in which EHS partnership children will be enrolled. Any substitute teachers hired and employed by Provider shall meet all requirements detailed herein.
- 17. Training.** Provider will work with HCDE to develop professional development plans for all teachers working with EHS children, and to ensure access to professional development experiences that will foster the skills necessary to develop consistent, stable and supportive relationships with very young children, including trainings focused on increased knowledge of infant and toddler development, safety issues in infant and toddler care (e.g., reducing the risk of Sudden Infant Death Syndrome) and methods for communicating effectively with infants and toddlers, their parents and other staff members. Provider and Provider's staff shall participate in required orientation, ongoing training, and professional development as deemed necessary by HCDE and/or EHS.
- 18. Performance.** Provider agrees to use best efforts to provide the service(s) subject to this Agreement. Provider shall employ only orderly and competent workers, skilled in the performance of the services which shall be performed under this Agreement. Provider, its employees, subcontractors, and subcontractor's employees may not use or possess any firearms, alcoholic or other intoxicating beverages, illegal drugs or controlled substances while on the job or on HCDE's property, nor may such workers be intoxicated or under the influence of alcohol or drugs on HCDE's property.
- 19. Right to Use Name.** Provider hereby grants HCDE a non-exclusive right to use any of Provider's names, trademarks or logos, and copyrighted materials and to publish such.

### ARTICLE III: RESPONSIBILITIES OF HCDE

- 1. Administrative and Financial.** HCDE is responsible for ensuring that all administrative and financial management requirements of the EHS-CC grant are met. HCDE will provide financial and program management information to Provider on at least a quarterly basis and will work closely with Provider to establish a partnership budget.
- 2. Assistance to Provider.** HCDE shall assist Provider in obtaining an EHS-CC curriculum that is evidence-based and developmentally appropriate for infants and toddlers; completing referrals for community agency assistance for EHS-CC families that need help or who are in crisis, assisting all enrolled EHS-CC families in attaining comprehensive services, including physical, mental and oral health, education, nutrition, and parent engagement services; and assisting Provider's teachers in coordinating developmental, sensory, and behavioral screening and assistance with provision of follow-up services and assessments as mandated in the Head Start Performance Standards.
- 3. Compliance Monitoring.** HCDE shall incorporate Provider into an EHS-CC compliance monitoring and improvement plan system.

4. **Early Head Start Plan.** HCDE shall be responsible for determining eligibility, recruitment, placement, and follow-up for EHS children. HCDE shall provide a plan to deliver ongoing supplemental services to EHS children and families. HCDE shall implement a recruitment plan and selection criteria to ensure the program enrolls children most in need in the community, namely: (1) children with disabilities, (2) families that receive child care subsidies, and (3) families eligible for public assistance.
5. **Disability Plans.** HCDE shall develop a disabilities service plan for each EHS enrolled child with a disability.
6. **Payment.** HCDE shall pay Provider the rate for the categories indicated in the chart below per day for each EHS child enrolled in Provider’s EHS Child Care program, as evidenced by the attendance and enrollment records provided by Provider under this Agreement and verified, if necessary, by HCDE. The amount not to exceed \$117,000.

Age of EHS child	Subsidized	Not subsidized
Infant (0-17 months)	\$ 18.00	\$ 35.00
Toddler (18-35 months)	\$ 15.00	\$ 28.00

All subsidy status changes must be reported immediately to HCDE. The Provider has 10 business days to inform the Assistant Director of Early Head Start Child Care Partnerships (ADEHSCCP) in writing/email of student’s status change. If status change is not reported by the 10<sup>th</sup> workday, invoice adjustments will not be made. Overpayments will be recouped via reduction in future payments. HCDE shall enroll, pay the initial assessment fee(s), and monitor progress of Provider’s teachers to take Infant-Toddler Child Development Associate Credential classes.

In accordance with Texas Government Code § 2251.021, payments are due to Provider within forty-five (45) days after the later of the following: (1) the date the performance of the service under the Agreement is completed; or (2) the date HCDE receives an invoice for the service. Provider agrees to pay any subcontractors, if any, the appropriate share of the payment received from HCDE not later than the tenth (10th) day after the date Provider receives the payment from HCDE. The exceptions to payments made by HCDE and/or Provider listed in Texas Government Code § 2251.002 shall apply to this Agreement.

7. **Reimbursements.** HCDE may reimburse Provider for the costs of expenses incurred by Provider in the course of gaining and/or maintaining compliance with EHS-CC program requirements and/or increasing the quality of Provider’s EHS Child Care program. In order to receive reimbursement from HCDE, Provider must (1) obtain written approval of the expense from an authorized HCDE representative prior to Provider incurring the expense and (2) submit documentation of the expense (i.e., receipt, invoice, etc.) to HCDE. HCDE, in its sole discretion, may approve or disapprove Provider’s request(s) for reimbursements under this Section.
8. **Training.** HCDE shall provide training to Provider prior to participation in the EHS Child Care program. HCDE shall provide Provider’s EHS teachers with ongoing training, professional development plans, coaching, and mentoring, including providing technical assistance and training to Provider’s teachers throughout the CDA credentialing process. Professional development plans will emphasize continuity of care and relational learning that supports EHS children and their families and fosters school readiness.

#### ARTICLE IV: TERM AND TERMINATION

1. **Term.** This Agreement is effective from August 1, 2021 through August 31, 2022. The Parties may renew this Agreement by written agreement for up to four (4) additional terms of no more than one (1) year increments. All services must be completed during the effective dates of the Agreement.

2. **Termination of Contract.** This Agreement shall remain in effect until (1) the Agreement expires by its terms or (2) the Agreement is terminated by mutual agreement of HCDE and Provider. In the event of a breach or default of the Agreement and/or the procurement solicitation by Provider, HCDE reserves the right to enforce the performance of the Agreement and/or the procurement solicitation in any manner prescribed by law or deemed to be in the best interest of HCDE. HCDE further reserves the right to terminate the Agreement immediately in the event Provider fails to: (1) meet schedules, deadlines, and/or delivery dates within the time specified in this Agreement, the procurement solicitation, and/or set by HCDE; (2) comply with EHS program requirements, HSPPS, HHS Standards, or DFPS Minimum Standards; (3) maintain all required licenses, certifications, permits, or other required documentation; or (4) otherwise perform in accordance with this Agreement and/or the procurement solicitation. HCDE also reserves the right to terminate the Agreement immediately, with written notice to Provider, if HCDE believes, in its sole discretion, that it is in the best interest of HCDE to do so. Provider agrees that HCDE shall not be liable for damages in the event that HCDE declares Provider to be in default or breach of this Agreement and/or the procurement solicitation. Provider further agrees that upon termination of the Agreement for any reason, Provider shall, in good faith and with reasonable cooperation, aid in the transition to any new arrangement and/or Provider.

## ARTICLE V: GENERAL PROVISIONS

1. **Amendment.** No amendment of this Agreement shall be permitted unless first approved in writing by HCDE, and no such amendments shall have any effect unless and until a written amendment to this Agreement is executed by HCDE's Superintendent or its Assistant Superintendent for Business Services (or their designees) after any necessary approvals have been obtained from the HCDE Board of Trustees.
2. **Assignment of Agreement.** Provider may not assign this Agreement or any of its rights, duties, or obligations hereunder without the prior written approval of HCDE. Any attempted assignment of this Agreement by Provider shall be null and void. Any obligation, responsibility, or requirement imposed on Provider or HCDE property provided to Provider under this Agreement may not be transferred, assigned, subcontracted, mortgaged, pledged, or otherwise disposed of or encumbered in any way by Provider without the prior written approval of HCDE. Provider is required to notify HCDE when any material change in operations occurs, including but not limited to, changes to or revocation of required licenses, certifications, permits, or other documentation necessary to perform this Agreement; bankruptcy; material changes in financial condition; change of ownership; and the like, within three (3) business days of such change.
3. **Captions.** The captions herein are for convenience and identification purposes only, are not an integral part hereof, and are not to be considered in the interpretation of any part hereof.
4. **Entire Agreement.** This Agreement, the procurement solicitation issued by HCDE, and Provider's proposal submitted in response to HCDE's procurement solicitation RFP#21/029IA, and the attached and incorporated addendum or exhibits, including, but not limited to Exhibit A, contain the entire agreement of the parties relative to the purpose(s) of the Agreement and supersede any other representations, agreements, arrangements, negotiations, or understanding, oral or written, between the parties to this Agreement. In the event of a conflict between this Agreement and the procurement solicitation issued by HCDE or Provider's proposal submitted in response to HCDE's procurement solicitation, this Agreement shall control. In the event of a conflict between the procurement solicitation issued by HCDE and Provider's proposal submitted in response to HCDE's procurement solicitation, HCDE's procurement solicitation shall control. This Agreement supersedes any conflicting terms and conditions on any purchase or work orders, invoices, checks, order acknowledgements, forms, or similar documents relating hereto and which may be issued by Provider after the Effective Date of this Agreement.

- 5. Equal Opportunity.** It is the policy of HCDE not to discriminate on the basis of race, color, National origin, gender, limited English proficiency or handicapping conditions in its programs. Provider agrees not to discriminate against any employee or applicant for employment to be employed in the performance of this Agreement, with respect to hire, tenure, terms, conditions and privileges of employment, or a matter directly or indirectly related to employment, because of age (except where based on a bona fide occupational qualification), sex (except where based on a bona fide occupational qualification) or race, color, religion, national origin, or ancestry. Provider further agrees that every subcontract entered into for the performance of this Agreement shall contain a provision requiring non-discrimination in employment herein specified, binding upon each subcontractor. Breach of this covenant may be regarded as a material breach of the Agreement.
- 6. Force Majeure.** Neither HCDE or Provider shall be deemed to have breached any provision of this Agreement as a result of any delay, failure in performance, or interruption of service resulting directly or indirectly from acts of God, network failures, acts of civil or military authorities, civil disturbances, wars, energy crises, fires, transportation contingencies, interruptions in third-party telecommunications or Internet equipment or service, other catastrophes, or any other occurrences which are reasonably beyond such party's control. The parties to this Agreement are required to use due caution and preventive measures to protect against the effects of force majeure, and the burden of proving that a force majeure event has occurred shall rest on the party seeking relief under this provision. The party seeking relief due to force majeure is required to promptly notify the other party in writing, citing the details of the force majeure event and relief sought, and shall resume performance immediately after the obstacles to performance caused by a force majeure event have been removed, provided the Agreement has not been terminated. Delay or failure of performance, by either party to this Agreement, caused solely by a force majeure event, shall be excused for the period of delay caused solely by the force majeure event. Neither party shall have any claim for damages against the other resulting from delays caused solely by force majeure. Notwithstanding any other provision of this Agreement, in the event the Provider's performance of its obligations under this Agreement is delayed or stopped by a force majeure event, HCDE shall have the option to terminate this Agreement. This section shall not be interpreted as to limit or otherwise modify any of HCDE's contractual, legal, or equitable rights.
- 7. Non-Appropriation.** Notwithstanding any other provision of this Agreement or obligation imposed on HCDE by this Agreement, HCDE shall have the right to terminate this Agreement without default or liability to Provider resulting from such termination, effective as of the end of any fiscal year of HCDE or of HCDE's Early Head Start program, if it is determined by HCDE, in HCDE's sole discretion, that there are insufficient funds to extend this Agreement, in accordance with Texas Local Government Code 271.903 concerning non-appropriation of funds for multi-year contracts. HCDE anticipates it will receive Early Head Start grant funds from the United States Department of Health and Human Services in an amount equal to the cost of services to be provided under this Agreement. Provider further acknowledges that federal funds will be used to make all payments and pay for all of HCDE's obligations under this Agreement and that this Agreement is subject to appropriation and approval of an Early Head Start Grant by the United States federal government for the specific purpose of providing Early Head Start services in east and northeast Harris County. Notwithstanding anything to the contrary in this Agreement, this Agreement is contingent on HCDE receiving such funds. If HCDE does not receive sufficient funding to operate the Early Head Start program, HCDE may terminate this Agreement or reduce the scope of services provided under this Agreement, in HCDE's sole discretion, without penalty or further obligation to Provider, at any time upon written notice to Provider.
- 8. Governing Law and Venue.** The laws of the State of Texas, without regard to its provisions on conflicts of laws, govern this Agreement. Any dispute under this Agreement must be brought in the state and federal courts located in Houston, Harris County, Texas, and the parties hereby submit to the exclusive jurisdiction of said courts.

- 9. HCDE Property.** In the event of loss, damage, or destruction of any property owned by or loaned by HCDE that is caused by Provider or Provider's representative, agent, employee, contractor, or anyone under Provider's care, supervision, custody, and/or control, Provider shall indemnify HCDE and pay to HCDE the full value of or the full cost of repair or replacement of such property, whichever is greater, within thirty (30) days of Provider's receipt of written notice of HCDE's determination of the amount due. If Provider fails to make timely payment, HCDE may obtain such money from Provider by any means permitted by law, including, without limitation, offset or counterclaim against any money otherwise due to Provider by HCDE.
- 10. Indemnification.** PROVIDER SHALL INDEMNIFY AND HOLD HCDE HARMLESS FROM ALL CLAIMS, LIABILITIES, COSTS, SUITS OF LAW OR IN EQUITY, EXPENSES, ATTORNEYS' FEES, FINES, PENALTIES OR DAMAGES ARISING FROM THE ACTS OR OMISSIONS OF PROVIDER, PROVIDER'S EMPLOYEES, AGENTS, CONTRACTORS, OR ANYONE UNDER PROVIDER'S CARE, SUPERVISION, CUSTODY, OR CONTROL, IN CONNECTION WITH THIS AGREEMENT. Provider's obligations under this clause shall survive expiration or termination of this Agreement.
- 11. Interpretation.** Provider agrees that the normal rules of construction that require that any ambiguities in this Agreement are to be construed against the drafter shall not be employed in the interpretation of this Agreement.
- 12. IRS W-9.** In order to receive payment under this Agreement, Provider shall have a current I.R.S. W-9 Form on file with HCDE.
- 13. No Agency or Endorsements.** HCDE and Provider are independent contractors and have no power or authority to assume or create any obligation or responsibility on behalf of the other party. This Agreement shall not be construed or deemed an endorsement of a specific company or product. It is the intention of the parties that Provider is independent of HCDE and is not an employee, agent, joint venturer, or partner of HCDE, and nothing in this Agreement shall be interpreted or construed as creating or establishing the relationship of employer and employee, agent, joint venturer or partner, between HCDE and Provider or HCDE and any of Provider's agents. Provider agrees that HCDE has no responsibility for any conduct of any of Provider's employees, agents, representatives, contractors, subcontractors, or anyone under Provider's care, supervision, custody, or control.
- 14. Notice.** Any notice provided under the terms of this Agreement by either party to the other shall be in writing and shall be given by hand-delivery or by certified or registered mail, return receipt requested. Notice shall be sufficient if made or addressed as follows:

HCDE  
Attention: James Colbert, Jr., County School Superintendent  
6300 Irvington Blvd.  
Houston, Texas 77022

Community Partners Early Childhood Development Center  
Attention: Alice Kirkmon  
4901 Lockwood Dr.  
Houston, Texas 77026

Notice shall be deemed effective upon receipt. Each party may change the address at which notice may be sent to that party by giving notice of such change to the other party by certified or registered mail, return receipt requested.

- 15. Records Retention.** Provider shall maintain its records and accounts in a manner that shall assure a full accounting for all services provided by Provider under this Agreement. These records and accounts shall be retained by Provider and made available for audit by HCDE for a period of not less than two (2) years from the date of completion of the services, receipt of the goods, or the date of the receipt by HCDE of Provider's final invoice or claim for payment in connection with this Agreement, whichever is later. If an audit has been announced, Provider shall retain its records and accounts until such audit has been completed.
- 16. Right to Audit.** HCDE, upon written notice, shall have the right to audit all of Provider's records and accounts relating to this Agreement. Records subject to audit shall include, but are not limited to, records which may have a bearing on matters of interest to HCDE in connection with the Agreement and shall be open to inspection and subject to audit and/or reproduction by HCDE or its authorized representative(s) to the extent necessary to adequately permit evaluation and verification of: (a) Provider's compliance with this Agreement and the requirements of the solicitation, (b) compliance with provisions for computing billings, attendance records, and other documents submitted to HCDE, and/or (c) any other matters related to this Agreement.
- 17. Safety.** Provider, its subcontractors, and their respective employees shall comply fully with all applicable federal, state, and local safety and health laws, ordinances, rules, and regulations in the performance of services under this Agreement, including, without limitation, those promulgated by HCDE, EHS, or HHS. In case of conflict, the most stringent safety requirements shall govern. Provider shall comply with all other safety guidelines and standards as required by HCDE. Provider shall indemnify and hold HCDE harmless from and against all claims, demands, suits, actions, judgments, fines, penalties, and liability of every kind arising from the breach of Provider's obligations under this provision.
- 18. Severability.** In the event that any one or more of the provisions contained in this Agreement shall for any reason be held to be invalid, illegal, or unenforceable in any respect, such invalidity, illegality, or unenforceability shall not affect any other provisions, and the Agreement shall be construed as if such invalid, illegal, or unenforceable provision had never been contained in it.
- 19. Subcontractors.** If Provider uses subcontractors in the performance of any part of this Agreement, Provider shall be fully responsible to HCDE for all acts and omissions of the subcontractors just as Provider is responsible for Provider's own acts and omissions. Nothing in this Agreement shall create for the benefit of any such subcontractor any contractual relationship between HCDE and any such subcontractor, nor shall it create any obligation on the part of HCDE to pay or to see to the payment of any moneys due any such subcontractor except as may otherwise be required by law.
- 20. Taxes.** HCDE is tax-exempt, and HCDE shall not pay taxes for goods and/or services provided under this Agreement. Provider represents and warrants that it shall pay all taxes or similar amounts resulting from this Agreement, including, without limitation, any federal, state, or local income, sales or excise taxes of Provider or its employees. HCDE shall not be liable for any taxes resulting from this Agreement.
- 21. Tax Responsibilities of Provider and Indemnification for Taxes.** Provider and all subcontractor(s) of Provider shall pay all federal, state, and local taxes applicable to their operation and any persons employed by Provider and all subcontractors of Provider. Provider shall require all subcontractors to hold HCDE harmless from any responsibility for taxes, damages, and interest. If applicable, contributions required under federal, state, and/or local laws and regulations and any other costs including, but not limited to, transaction privilege taxes, unemployment compensation insurance, Social Security, and Worker's Compensation, shall be the sole responsibility of Provider.
- 22. Third Parties.** Neither this Agreement, nor any provision or term hereof, nor any inclusion by reference shall be construed as being for the benefit of any party not in signatory hereto.

**23. Waiver.** No failure on the part of either party at any time to require the performance by the other party of any term hereof shall be taken or held to be a waiver of such term or in any way affect such party's right to enforce such term, and no waiver on the part of either party of any term hereof shall be taken or held to be a waiver of any other term hereof or the breach thereof. No waiver, alteration, or modification of any of the provisions of this Contract shall be binding unless in writing and signed by duly authorized representatives of the parties hereto.

**IN WITNESS HEREOF**, HCDE and Provider have executed this Agreement to be effective on the date specified in Article IV, 1. Term, above.

Harris County Department of Education

Community Partners Early Childhood Development Center

*Alice Kirkmon*

Alice Kirkmon (Jun 23, 2021 11:14 CDT)

\_\_\_\_\_  
James Colbert, Jr.  
County School Superintendent

\_\_\_\_\_  
Alice Kirkmon

Alice Kirkmon

\_\_\_\_\_  
Printed Name

Owner

\_\_\_\_\_  
Title

06/23/2021

\_\_\_\_\_  
Date

\_\_\_\_\_  
Date



**EARLY HEAD START CHILD CARE PARTNERSHIP AGREEMENT  
BETWEEN  
HARRIS COUNTY DEPARTMENT OF EDUCATION  
AND  
SUCCESSFUL STARTERS LEARNING ACADEMY II**

This Early Head Start Child Care Agreement (“Agreement”) is entered into by and between the Harris County Department of Education (“HCDE”), a political subdivision of the State of Texas, having its principal office and place of business at 6300 Irvington Blvd., Houston, Texas 77022 and Successful Starters Learning Academy II (“Provider”), having its principal office and place of business at 10635 Homestead Rd. #B, Houston, Texas 77016. HCDE and Provider shall be referred to collectively herein as the “Parties”.

**RECITALS**

**WHEREAS**, HCDE is a recipient of Early Head Start Child Care grant funds;

**WHEREAS**, Provider submitted a proposal in response to RFP #21/0291A the procurement solicitation for Early Head Start Child Care services issued by HCDE;

**WHEREAS**, Provider’s proposal has been accepted and awarded by HCDE;

**WHEREAS**, HCDE and Provider desire to create a partnership to accomplish the shared objective of increasing access to quality comprehensive early childhood service for low-income families with infants and toddlers in east and northeast Harris County; and

**WHEREAS**, this Agreement sets forth the respective roles and responsibilities of Provider and HCDE in providing Early Head Start Child Care services for infants and toddlers (0-3 years old) in compliance with Early Head Start Child Care grant requirements and Head Start Performance Standards.

**NOW, THEREFORE**, in consideration of the mutual covenants and conditions contained in this Agreement and other good and valuable consideration, the receipt and sufficiency of which are hereby acknowledged, HCDE and Provider, intending to be legally bound, and subject to the terms, conditions, and provisions of this Agreement, agree as follows:

**ARTICLE 1: MUTUAL RESPONSIBILITIES OF THE PARTIES**

- 1. Confidentiality.** The Parties agree to secure the confidentiality of all information and records in accordance with applicable federal and state laws, rules, and regulations, including but not limited to, the Health Insurance Portability and Accountability Act (HIPAA) and the Family Educational Rights and Privacy Act (FERPA), as applicable, and HCDE’s confidentiality procedures. The Parties understand that HIPAA and FERPA govern the privacy and security of medical and educational records and information and agree to abide by HIPAA and FERPA rules and regulations, as applicable. Provider also acknowledges that HCDE is subject to the Texas Public Information Act, and Provider waives any claim against and releases from liability HCDE, its officers, employees, agents, and attorneys with respect to disclosure of information provided under or in this Agreement or otherwise created, assembled, maintained, or held by Provider and determined by HCDE, the Attorney General of Texas, or a court of law to be subject to disclosure under the Texas Public Information Act.

2. **Early Head Start Child Care Program.** The Parties agree to form an Early Head Start Child Care Partnership to provide Early Head Start Child Care (“EHS-CC”) services for up to 16 children ages 0-3 years old at Provider’s child care facility located at 10635 Homestead Rd. #B, Houston, Texas 77016 in compliance with EHS-CC program requirements established by the United States Department of Health and Human Service (“HHS”). The Parties shall mutually assure that the families of all the EHS-CC Partnership children served at Provider’s facility shall have access to the full range of EHS-CC services and shall be mutually responsible for assuring continuity in implementing EHS-CC services. The Parties shall work in collaboration to ensure all EHS compliance issues are addressed and met.
3. **Eligibility, Recruitment, Selection, Enrollment and Attendance.** The Parties will work together to ensure all children and families enrolled in the EHS-CC partnership are either income or categorically eligible for Early Head Start Services. The Parties will work together to identify partnership eligible families currently enrolled in Provider’s child care program. HCDE will refer partnership eligible families to Provider when appropriate.
4. **Medical Screenings.** HCDE and Provider shall coordinate to provide all required developmental, sensory, behavioral and medical screenings for EHS-CC children within required 45-day timeframe and shall make referrals for follow-up treatment services, as needed.
5. **Reporting.** HCDE and Provider will meet quarterly to review this partnership. Any compliance monitoring issues or professional development needs will be addressed at these meetings. Minutes will be recorded and kept on site at the administrative offices of HCDE and Provider. Any correction plans developed in these meetings will also be recorded and kept on-site, with updates and completion of correction plans recorded in meeting minutes.
6. **Special Services.** HCDE and Provider shall provide special services to children diagnosed with disabilities, including training on inclusion of these children in a full range of activities. HCDE and Provider shall participate in transition meetings and Child Find meetings for enrolled children.
7. **Special Programs and Projects.** HCDE and Provider shall collaborate to plan and provide parent activities including Parent, Family and Community Engagement meetings, programs and projects. HCDE and Provider shall also collaborate to establish community partnerships that will offer resources to children and families.

## ARTICLE II: RESPONSIBILITIES OF PROVIDER

1. **Administrative and Financial.** Provider will provide program management information to HCDE on at least a quarterly basis. Provider will timely inform HCDE of subsidy eligibility changes for enrolled partnership families.
2. **Compliance with Laws and EHS Program Requirements.** Provider shall comply with all EHS program requirements, Head Start Program Performance Standards (“HSPPS”), HHS Standards, and Texas Department of Family and Protective Services (“DFPS”) Minimum Standards, including but not limited to, all HCDE and EHS child attendance policies and procedures, all HCDE and EHS health and safety practices, and all DFPS Child Care Licensing regulations. Provider shall comply with all federal, state, and local laws, statutes, ordinances, rules, and regulations, including, if applicable, workers’ compensation laws, minimum and maximum salary and wage statutes and regulations, prompt payment and licensing laws and regulations. Provider agrees that the certifications and agreements included on the HCDE Vendor Certification Forms, attached hereto as Exhibit A and incorporated by reference in this Agreement for all purposes, are true and correct. For the entire duration of this Agreement, Provider shall maintain all required

licenses, certifications, permits, and any other documentation necessary to perform this Agreement, including a valid DFPS Child Care License. When required or requested by HCDE, Provider shall furnish HCDE with satisfactory proof of Provider's compliance with this provision.

3. **Compliance Monitoring.** Provider will participate in the compliance monitoring and improvement plan system established by HCDE and will allow access to HCDE, EHS, and/or HHS and their respective authorized representatives for classroom and staff observations as well as to all documentation relating to this Agreement.
4. **Criminal History Review.** Prior to commencing any work under this Agreement, Provider must certify that for each covered employee, volunteer or contractor of Provider who will have direct contact with students, Provider has obtained, as required by Texas Education Code Section 22.0834: (a) state criminal history record information from a law enforcement or criminal justice agency or a private entity that is a consumer reporting agency governed by the Fair Credit Reporting Act (15 U.S.C. Section 1681 et seq.) for each covered employee of Provider employed before January 1, 2008; and (b) national criminal history record information for each employee of Provider employed on or after January 1, 2008. Provider must also obtain similar certifications of compliance with Texas Education Code Chapter 22's requirements from any subcontractors. Covered employees with disqualifying criminal history are prohibited from serving at HCDE; Provider and any subcontracting entity may not permit a covered employee to provide services at a child care facility if the employee has been convicted of a felony or misdemeanor offense that would prevent a person from being employed under Tex. Educ. Code § 22.085(a) (i.e., Title 5 felony or an offense requiring registration as a sex offender and victim was under 18 years of age or was enrolled in a public school at the time the offense occurred).
5. **Curriculum and Child Assessment:** Provider will implement an evidence-based early childhood curriculum that is developmentally appropriate for infants and toddlers and conduct ongoing assessment(s) of children to individualize the instruction and learning for each child.
6. **Eligibility, Recruitment, Selection, Enrollment and Attendance.** Provider will provide HCDE with attendance reports by each Tuesday. Provider must promote regular attendance and partner with HCDE EHS to implement strategies to support a monthly average daily attendance rate of a minimum of 85% per student. Provider will work closely with enrolled families and HCDE to successfully complete subsidy applications and subsidy re-determinations. Provider shall comply with the plan developed by HCDE to deliver ongoing supplemental services to EHS children and families. Provider shall also comply with the disabilities service plan developed by HCDE for each EHS enrolled child with a disability.
7. **Facility and Equipment Requirements.** Provider shall provide a child care facility that serves children ages 0–3 years old. Classroom(s) at Provider's child care facility may have a maximum of eight children with a ratio of one teacher per four children, and classroom(s) must accommodate a minimum of 35 square feet per child, not including crib space. Provider's facility shall meet all Head Start Program Performance Standards, EHS Program Standards and all DFPS Child Care Licensing regulations, including requirements for facilities, square footage, health and safety, and appropriate crib and sleep spacing and arrangements. Provider's facility shall include secure space for confidential files to be kept locked on Provider's premises, and Provider shall ensure that all confidential files are kept locked in said secure space on Provider's premises. Provider shall maintain a working computer and email capability for the entire Term of this Agreement. Provider shall maintain and secure any property, including all equipment and materials, provided by HCDE, and all such property shall remain the sole property of HCDE. Provider agrees that upon termination or expiration of the Agreement, Provider shall return all HCDE property, including all equipment and materials provided by HCDE, to HCDE within thirty of days after the effective date of termination or expiration of this Agreement.

- 8. Full Day/Full Year Early Head Start Child Care.** Provider shall operate a full-day/full-year EHS program as defined by HCDE and EHS and shall provide comprehensive child development services to all EHS children in its care pursuant to this Agreement and in accordance with the specifications identified in the Early Head Start rules and regulations. Provider shall provide EHS CC services at least ten (10) hours per day and at least 48 weeks per year. Provider shall submit annual service calendars to HCDE annually by June 30<sup>th</sup> of each year during the Term to enable HCDE to verify that the required weeks of service are provided. Provider shall implement educational services in accordance with EHS and HCDE requirements.
- 9. Health and Nutrition.** Provider shall enroll in the United States Department of Agriculture’s Child and Adult Care Food Program (“CACFP”), maintain good standing within CACFP, and ensure that children receive two thirds of the required daily nutrition while participating in CACFP. Provider shall provide breakfast, lunch, and afternoon snack to all EHS children, and all meals and snacks served by Provider must meet EHS requirements.
- 10. Home Visits; Parent-Teacher Conferences.** Provider shall make, at a minimum, two home visits per year for each EHS child served by Provider pursuant to this Agreement. Provider shall hold two parent-teacher conferences per year with each EHS enrolled family or primary guardian. Provider shall maintain adequate documentation of said home visits and parent-teacher conferences.
- 11. Inspection.** Provider shall allow HCDE staff and its authorized representatives, at any time during normal business hours, with or without notice, to inspect Provider’s facilities; observe Provider’s performance; and observe, evaluate, screen, and interact with EHS children served by Provider pursuant to this Agreement.
- 12. Insurance.** Provider is required to maintain General Liability Insurance coverage in an amount of \$300,000 per occurrence for negligence and to provide HCDE with copies of certificates of insurance. Certificates of Insurance, name and address of Provider, the limits of liability, the effective dates of each policy, and policy number shall be delivered to HCDE prior to commencement of any work under this Agreement and updated certificates of insurance shall be submitted to HCDE annually. The insurance company insuring Provider shall be licensed in the State of Texas and shall be acceptable to HCDE. Provider shall give HCDE a minimum of ten (10) days’ notice prior to any modifications or cancellation of said policies of insurance. Provider shall require all subcontractors performing any work under or relating to this Agreement to maintain coverage as specified herein. Upon request, certified copies of original insurance policies shall be furnished to HCDE. HCDE reserves the right to require additional insurance should HCDE deem additional insurance necessary, in HCDE’s sole discretion.
- 13. Parent and Community Engagement.** Provider will work closely with HCDE to ensure EHS parents are engaged and included in the full range of child development and family support services that are available and appropriate for each family. This will include a parent advisory committee with representation from partnership parents as well as members of the community, as appropriate. Provider will engage parents and the community to obtain non-federal shares that are reasonable and necessary for the accomplishment of EHS program objectives.
- 14. Reporting and Recordkeeping.** For all EHS children served by Provider pursuant to this Agreement, Provider shall maintain up-to-date records of children’s attendance, menus, medical conditions (including appropriate consent forms) and all other items required by HCDE, HHS, DFPS Child Care Licensing, CACFP, and any governmental authority or applicable funding agency. Provider shall maintain daily performance and attendance reports, signature sheets and other documents required by HCDE and shall submit such reports to the HCDE Accounts Payable Department on a semi-monthly basis no later than the 1st and 5th business day after the due date. Provider shall maintain annual service calendars and shall submit such service calendars to HCDE annually by June 30<sup>th</sup> of each year during the Term to enable HCDE to verify that the required weeks of service are provided.

- 15. Solicitation of Parental Contributions Prohibited.** Provider shall not require or ask EHS parents to supply any items, including diapers, food, cash, and/or reimbursements for EHS children in Provider's care.
- 16. Teaching Staff Credentials; Teacher-Child Ratio; Group Size.** Provider shall hire and employ qualified teachers and ensure all teaching staff attend all classes and complete all requirements necessary to obtain a Child Development Associate ("CDA") credential for Infant and Toddler Caregivers within twelve months from beginning services. The Lead Teacher in each EHS partnership classroom must have a currently active CDA credential for Infant and Toddler Caregivers or an equivalent credential that addresses comparable competencies. Provider shall maintain a teacher-child ratio of one teacher for every four children. No more than eight children will be placed in any one classroom in which EHS partnership children will be enrolled. Any substitute teachers hired and employed by Provider shall meet all requirements detailed herein.
- 17. Training.** Provider will work with HCDE to develop professional development plans for all teachers working with EHS children, and to ensure access to professional development experiences that will foster the skills necessary to develop consistent, stable and supportive relationships with very young children, including trainings focused on increased knowledge of infant and toddler development, safety issues in infant and toddler care (e.g., reducing the risk of Sudden Infant Death Syndrome) and methods for communicating effectively with infants and toddlers, their parents and other staff members. Provider and Provider's staff shall participate in required orientation, ongoing training, and professional development as deemed necessary by HCDE and/or EHS.
- 18. Performance.** Provider agrees to use best efforts to provide the service(s) subject to this Agreement. Provider shall employ only orderly and competent workers, skilled in the performance of the services which shall be performed under this Agreement. Provider, its employees, subcontractors, and subcontractor's employees may not use or possess any firearms, alcoholic or other intoxicating beverages, illegal drugs or controlled substances while on the job or on HCDE's property, nor may such workers be intoxicated or under the influence of alcohol or drugs on HCDE's property.
- 19. Right to Use Name.** Provider hereby grants HCDE a non-exclusive right to use any of Provider's names, trademarks or logos, and copyrighted materials and to publish such.

### **ARTICLE III: RESPONSIBILITIES OF HCDE**

- 1. Administrative and Financial.** HCDE is responsible for ensuring that all administrative and financial management requirements of the EHS-CC grant are met. HCDE will provide financial and program management information to Provider on at least a quarterly basis and will work closely with Provider to establish a partnership budget.
- 2. Assistance to Provider.** HCDE shall assist Provider in obtaining an EHS-CC curriculum that is evidence-based and developmentally appropriate for infants and toddlers; completing referrals for community agency assistance for EHS-CC families that need help or who are in crisis, assisting all enrolled EHS-CC families in attaining comprehensive services, including physical, mental and oral health, education, nutrition, and parent engagement services; and assisting Provider's teachers in coordinating developmental, sensory, and behavioral screening and assistance with provision of follow-up services and assessments as mandated in the Head Start Performance Standards.
- 3. Compliance Monitoring.** HCDE shall incorporate Provider into an EHS-CC compliance monitoring and improvement plan system.

4. **Early Head Start Plan.** HCDE shall be responsible for determining eligibility, recruitment, placement, and follow-up for EHS children. HCDE shall provide a plan to deliver ongoing supplemental services to EHS children and families. HCDE shall implement a recruitment plan and selection criteria to ensure the program enrolls children most in need in the community, namely: (1) children with disabilities, (2) families that receive child care subsidies, and (3) families eligible for public assistance.
5. **Disability Plans.** HCDE shall develop a disabilities service plan for each EHS enrolled child with a disability.
6. **Payment.** HCDE shall pay Provider the rate for the categories indicated in the chart below per day for each EHS child enrolled in Provider’s EHS Child Care program, as evidenced by the attendance and enrollment records provided by Provider under this Agreement and verified, if necessary, by HCDE. The amount not to exceed \$117,000.

Age of EHS child	Subsidized	Not subsidized
Infant (0-17 months)	\$ 18.00	\$ 35.00
Toddler (18-35 months)	\$ 15.00	\$ 28.00

All subsidy status changes must be reported immediately to HCDE. The Provider has 10 business days to inform the Assistant Director of Early Head Start Child Care Partnerships (ADEHSCCP) in writing/email of student’s status change. If status change is not reported by the 10<sup>th</sup> workday, invoice adjustments will not be made. Overpayments will be recouped via reduction in future payments. HCDE shall enroll, pay the initial assessment fee(s), and monitor progress of Provider’s teachers to take Infant-Toddler Child Development Associate Credential classes.

In accordance with Texas Government Code § 2251.021, payments are due to Provider within forty-five (45) days after the later of the following: (1) the date the performance of the service under the Agreement is completed; or (2) the date HCDE receives an invoice for the service. Provider agrees to pay any subcontractors, if any, the appropriate share of the payment received from HCDE not later than the tenth (10th) day after the date Provider receives the payment from HCDE. The exceptions to payments made by HCDE and/or Provider listed in Texas Government Code § 2251.002 shall apply to this Agreement.

7. **Reimbursements.** HCDE may reimburse Provider for the costs of expenses incurred by Provider in the course of gaining and/or maintaining compliance with EHS-CC program requirements and/or increasing the quality of Provider’s EHS Child Care program. In order to receive reimbursement from HCDE, Provider must (1) obtain written approval of the expense from an authorized HCDE representative prior to Provider incurring the expense and (2) submit documentation of the expense (i.e., receipt, invoice, etc.) to HCDE. HCDE, in its sole discretion, may approve or disapprove Provider’s request(s) for reimbursements under this Section.
8. **Training.** HCDE shall provide training to Provider prior to participation in the EHS Child Care program. HCDE shall provide Provider’s EHS teachers with ongoing training, professional development plans, coaching, and mentoring, including providing technical assistance and training to Provider’s teachers throughout the CDA credentialing process. Professional development plans will emphasize continuity of care and relational learning that supports EHS children and their families and fosters school readiness.

#### ARTICLE IV: TERM AND TERMINATION

1. **Term.** This Agreement is effective from August 1, 2021 through August 31, 2022. The Parties may renew this Agreement by written agreement for up to four (4) additional terms of no more than one (1) year increments. All services must be completed during the effective dates of the Agreement.

2. **Termination of Contract.** This Agreement shall remain in effect until (1) the Agreement expires by its terms or (2) the Agreement is terminated by mutual agreement of HCDE and Provider. In the event of a breach or default of the Agreement and/or the procurement solicitation by Provider, HCDE reserves the right to enforce the performance of the Agreement and/or the procurement solicitation in any manner prescribed by law or deemed to be in the best interest of HCDE. HCDE further reserves the right to terminate the Agreement immediately in the event Provider fails to: (1) meet schedules, deadlines, and/or delivery dates within the time specified in this Agreement, the procurement solicitation, and/or set by HCDE; (2) comply with EHS program requirements, HSPPS, HHS Standards, or DFPS Minimum Standards; (3) maintain all required licenses, certifications, permits, or other required documentation; or (4) otherwise perform in accordance with this Agreement and/or the procurement solicitation. HCDE also reserves the right to terminate the Agreement immediately, with written notice to Provider, if HCDE believes, in its sole discretion, that it is in the best interest of HCDE to do so. Provider agrees that HCDE shall not be liable for damages in the event that HCDE declares Provider to be in default or breach of this Agreement and/or the procurement solicitation. Provider further agrees that upon termination of the Agreement for any reason, Provider shall, in good faith and with reasonable cooperation, aid in the transition to any new arrangement and/or Provider.

## ARTICLE V: GENERAL PROVISIONS

1. **Amendment.** No amendment of this Agreement shall be permitted unless first approved in writing by HCDE, and no such amendments shall have any effect unless and until a written amendment to this Agreement is executed by HCDE's Superintendent or its Assistant Superintendent for Business Services (or their designees) after any necessary approvals have been obtained from the HCDE Board of Trustees.
2. **Assignment of Agreement.** Provider may not assign this Agreement or any of its rights, duties, or obligations hereunder without the prior written approval of HCDE. Any attempted assignment of this Agreement by Provider shall be null and void. Any obligation, responsibility, or requirement imposed on Provider or HCDE property provided to Provider under this Agreement may not be transferred, assigned, subcontracted, mortgaged, pledged, or otherwise disposed of or encumbered in any way by Provider without the prior written approval of HCDE. Provider is required to notify HCDE when any material change in operations occurs, including but not limited to, changes to or revocation of required licenses, certifications, permits, or other documentation necessary to perform this Agreement; bankruptcy; material changes in financial condition; change of ownership; and the like, within three (3) business days of such change.
3. **Captions.** The captions herein are for convenience and identification purposes only, are not an integral part hereof, and are not to be considered in the interpretation of any part hereof.
4. **Entire Agreement.** This Agreement, the procurement solicitation issued by HCDE, and Provider's proposal submitted in response to HCDE's procurement solicitation (RFP #21/029IA), and the attached and incorporated addendum or exhibits, including, but not limited to Exhibit A, contain the entire agreement of the parties relative to the purpose(s) of the Agreement and supersede any other representations, agreements, arrangements, negotiations, or understanding, oral or written, between the parties to this Agreement. In the event of a conflict between this Agreement and the procurement solicitation issued by HCDE or Provider's proposal submitted in response to HCDE's procurement solicitation, this Agreement shall control. In the event of a conflict between the procurement solicitation issued by HCDE and Provider's proposal submitted in response to HCDE's procurement solicitation, HCDE's procurement solicitation shall control. This Agreement supersedes any conflicting terms and conditions on any purchase or work orders, invoices, checks, order acknowledgements, forms, or similar documents relating hereto and which may be issued by Provider after the Effective Date of this Agreement.

- 5. Equal Opportunity.** It is the policy of HCDE not to discriminate on the basis of race, color, National origin, gender, limited English proficiency or handicapping conditions in its programs. Provider agrees not to discriminate against any employee or applicant for employment to be employed in the performance of this Agreement, with respect to hire, tenure, terms, conditions and privileges of employment, or a matter directly or indirectly related to employment, because of age (except where based on a bona fide occupational qualification), sex (except where based on a bona fide occupational qualification) or race, color, religion, national origin, or ancestry. Provider further agrees that every subcontract entered into for the performance of this Agreement shall contain a provision requiring non-discrimination in employment herein specified, binding upon each subcontractor. Breach of this covenant may be regarded as a material breach of the Agreement.
- 6. Force Majeure.** Neither HCDE or Provider shall be deemed to have breached any provision of this Agreement as a result of any delay, failure in performance, or interruption of service resulting directly or indirectly from acts of God, network failures, acts of civil or military authorities, civil disturbances, wars, energy crises, fires, transportation contingencies, interruptions in third-party telecommunications or Internet equipment or service, other catastrophes, or any other occurrences which are reasonably beyond such party's control. The parties to this Agreement are required to use due caution and preventive measures to protect against the effects of force majeure, and the burden of proving that a force majeure event has occurred shall rest on the party seeking relief under this provision. The party seeking relief due to force majeure is required to promptly notify the other party in writing, citing the details of the force majeure event and relief sought, and shall resume performance immediately after the obstacles to performance caused by a force majeure event have been removed, provided the Agreement has not been terminated. Delay or failure of performance, by either party to this Agreement, caused solely by a force majeure event, shall be excused for the period of delay caused solely by the force majeure event. Neither party shall have any claim for damages against the other resulting from delays caused solely by force majeure. Notwithstanding any other provision of this Agreement, in the event the Provider's performance of its obligations under this Agreement is delayed or stopped by a force majeure event, HCDE shall have the option to terminate this Agreement. This section shall not be interpreted as to limit or otherwise modify any of HCDE's contractual, legal, or equitable rights.
- 7. Non-Appropriation.** Notwithstanding any other provision of this Agreement or obligation imposed on HCDE by this Agreement, HCDE shall have the right to terminate this Agreement without default or liability to Provider resulting from such termination, effective as of the end of any fiscal year of HCDE or of HCDE's Early Head Start program, if it is determined by HCDE, in HCDE's sole discretion, that there are insufficient funds to extend this Agreement, in accordance with Texas Local Government Code 271.903 concerning non-appropriation of funds for multi-year contracts. HCDE anticipates it will receive Early Head Start grant funds from the United States Department of Health and Human Services in an amount equal to the cost of services to be provided under this Agreement. Provider further acknowledges that federal funds will be used to make all payments and pay for all of HCDE's obligations under this Agreement and that this Agreement is subject to appropriation and approval of an Early Head Start Grant by the United States federal government for the specific purpose of providing Early Head Start services in east and northeast Harris County. Notwithstanding anything to the contrary in this Agreement, this Agreement is contingent on HCDE receiving such funds. If HCDE does not receive sufficient funding to operate the Early Head Start program, HCDE may terminate this Agreement or reduce the scope of services provided under this Agreement, in HCDE's sole discretion, without penalty or further obligation to Provider, at any time upon written notice to Provider.
- 8. Governing Law and Venue.** The laws of the State of Texas, without regard to its provisions on conflicts of laws, govern this Agreement. Any dispute under this Agreement must be brought in the state and federal courts located in Houston, Harris County, Texas, and the parties hereby submit to the exclusive jurisdiction of said courts.



- 9. HCDE Property.** In the event of loss, damage, or destruction of any property owned by or loaned by HCDE that is caused by Provider or Provider's representative, agent, employee, contractor, or anyone under Provider's care, supervision, custody, and/or control, Provider shall indemnify HCDE and pay to HCDE the full value of or the full cost of repair or replacement of such property, whichever is greater, within thirty (30) days of Provider's receipt of written notice of HCDE's determination of the amount due. If Provider fails to make timely payment, HCDE may obtain such money from Provider by any means permitted by law, including, without limitation, offset or counterclaim against any money otherwise due to Provider by HCDE.
- 10. Indemnification.** PROVIDER SHALL INDEMNIFY AND HOLD HCDE HARMLESS FROM ALL CLAIMS, LIABILITIES, COSTS, SUITS OF LAW OR IN EQUITY, EXPENSES, ATTORNEYS' FEES, FINES, PENALTIES OR DAMAGES ARISING FROM THE ACTS OR OMISSIONS OF PROVIDER, PROVIDER'S EMPLOYEES, AGENTS, CONTRACTORS, OR ANYONE UNDER PROVIDER'S CARE, SUPERVISION, CUSTODY, OR CONTROL, IN CONNECTION WITH THIS AGREEMENT. Provider's obligations under this clause shall survive expiration or termination of this Agreement.
- 11. Interpretation.** Provider agrees that the normal rules of construction that require that any ambiguities in this Agreement are to be construed against the drafter shall not be employed in the interpretation of this Agreement.
- 12. IRS W-9.** In order to receive payment under this Agreement, Provider shall have a current I.R.S. W-9 Form on file with HCDE.
- 13. No Agency or Endorsements.** HCDE and Provider are independent contractors and have no power or authority to assume or create any obligation or responsibility on behalf of the other party. This Agreement shall not be construed or deemed an endorsement of a specific company or product. It is the intention of the parties that Provider is independent of HCDE and is not an employee, agent, joint venturer, or partner of HCDE, and nothing in this Agreement shall be interpreted or construed as creating or establishing the relationship of employer and employee, agent, joint venturer or partner, between HCDE and Provider or HCDE and any of Provider's agents. Provider agrees that HCDE has no responsibility for any conduct of any of Provider's employees, agents, representatives, contractors, subcontractors, or anyone under Provider's care, supervision, custody, or control.
- 14. Notice.** Any notice provided under the terms of this Agreement by either party to the other shall be in writing and shall be given by hand-delivery or by certified or registered mail, return receipt requested. Notice shall be sufficient if made or addressed as follows:

HCDE  
Attention: James Colbert, Jr., County School Superintendent  
6300 Irvington Blvd.  
Houston, Texas 77022

Successful Starters Learning Academy II  
Attention: Carla Smith-Ford  
9118 Homestead Rd.  
Houston, Texas 77016

Notice shall be deemed effective upon receipt. Each party may change the address at which notice may be sent to that party by giving notice of such change to the other party by certified or registered mail, return receipt requested.

- 15. Records Retention.** Provider shall maintain its records and accounts in a manner that shall assure a full accounting for all services provided by Provider under this Agreement. These records and accounts shall be retained by Provider and made available for audit by HCDE for a period of not less than two (2) years from the date of completion of the services, receipt of the goods, or the date of the receipt by HCDE of Provider's final invoice or claim for payment in connection with this Agreement, whichever is later. If an audit has been announced, Provider shall retain its records and accounts until such audit has been completed.
- 16. Right to Audit.** HCDE, upon written notice, shall have the right to audit all of Provider's records and accounts relating to this Agreement. Records subject to audit shall include, but are not limited to, records which may have a bearing on matters of interest to HCDE in connection with the Agreement and shall be open to inspection and subject to audit and/or reproduction by HCDE or its authorized representative(s) to the extent necessary to adequately permit evaluation and verification of: (a) Provider's compliance with this Agreement and the requirements of the solicitation, (b) compliance with provisions for computing billings, attendance records, and other documents submitted to HCDE, and/or (c) any other matters related to this Agreement.
- 17. Safety.** Provider, its subcontractors, and their respective employees shall comply fully with all applicable federal, state, and local safety and health laws, ordinances, rules, and regulations in the performance of services under this Agreement, including, without limitation, those promulgated by HCDE, EHS, or HHS. In case of conflict, the most stringent safety requirements shall govern. Provider shall comply with all other safety guidelines and standards as required by HCDE. Provider shall indemnify and hold HCDE harmless from and against all claims, demands, suits, actions, judgments, fines, penalties, and liability of every kind arising from the breach of Provider's obligations under this provision.
- 18. Severability.** In the event that any one or more of the provisions contained in this Agreement shall for any reason be held to be invalid, illegal, or unenforceable in any respect, such invalidity, illegality, or unenforceability shall not affect any other provisions, and the Agreement shall be construed as if such invalid, illegal, or unenforceable provision had never been contained in it.
- 19. Subcontractors.** If Provider uses subcontractors in the performance of any part of this Agreement, Provider shall be fully responsible to HCDE for all acts and omissions of the subcontractors just as Provider is responsible for Provider's own acts and omissions. Nothing in this Agreement shall create for the benefit of any such subcontractor any contractual relationship between HCDE and any such subcontractor, nor shall it create any obligation on the part of HCDE to pay or to see to the payment of any moneys due any such subcontractor except as may otherwise be required by law.
- 20. Taxes.** HCDE is tax-exempt, and HCDE shall not pay taxes for goods and/or services provided under this Agreement. Provider represents and warrants that it shall pay all taxes or similar amounts resulting from this Agreement, including, without limitation, any federal, state, or local income, sales or excise taxes of Provider or its employees. HCDE shall not be liable for any taxes resulting from this Agreement.
- 21. Tax Responsibilities of Provider and Indemnification for Taxes.** Provider and all subcontractor(s) of Provider shall pay all federal, state, and local taxes applicable to their operation and any persons employed by Provider and all subcontractors of Provider. Provider shall require all subcontractors to hold HCDE harmless from any responsibility for taxes, damages, and interest. If applicable, contributions required under federal, state, and/or local laws and regulations and any other costs including, but not limited to, transaction privilege taxes, unemployment compensation insurance, Social Security, and Worker's Compensation, shall be the sole responsibility of Provider.
- 22. Third Parties.** Neither this Agreement, nor any provision or term hereof, nor any inclusion by reference shall be construed as being for the benefit of any party not in signatory hereto.

**23. Waiver.** No failure on the part of either party at any time to require the performance by the other party of any term hereof shall be taken or held to be a waiver of such term or in any way affect such party's right to enforce such term, and no waiver on the part of either party of any term hereof shall be taken or held to be a waiver of any other term hereof or the breach thereof. No waiver, alteration, or modification of any of the provisions of this Contract shall be binding unless in writing and signed by duly authorized representatives of the parties hereto.

**IN WITNESS HEREOF**, HCDE and Provider have executed this Agreement to be effective on the date specified in Article IV, 1. Term, above.

Harris County Department of Education

Successful Starters Learning Academy II

\_\_\_\_\_  
James Colbert, Jr.  
County School Superintendent

*Carla Smith-Ford*

Carla Smith-Ford (Jun 23, 2021 09:40 CDT)

\_\_\_\_\_  
Carla Smith-Ford

Carla Smith-Ford

\_\_\_\_\_  
Printed Name

Carla Smith-Ford - Owner-Director

\_\_\_\_\_  
Title

06/23/2021

\_\_\_\_\_  
Date

\_\_\_\_\_  
Date

**Regular Board Meeting**

**9.G.**

**Meeting Date:** July 21, 2021

**Title:**

**Submitted By:** Venetia Baldwin

**Recommended Action:** Approve

**HCDE Goal(s):**

**Additional Resource**

**Facilities/Technology**

**Personnel:**

**Approval Needed?:**

---

**Information**

**Posted Agenda Item:**

**Consider approval of consent to assignment of contract(s) by Trusted Capital Group to HUB International Limited (Vendor is part of the cafeteria plan and 401a and 403b administrator).**

**Subject:**

**Rationale:**

---

**Fiscal Impact**

**Attachments**

TCG

---

**Form Review**

Form Started By: Venetia Baldwin  
Final Approval Date: 07/12/2021

Started On: 07/12/2021 01:44 PM



May 17, 2021

Dear Valued Client,

We hope that this finds you, your colleagues, and your family well.

During this unprecedented time, Trusted Capital Group has remained singularly focused on supporting its valued clients. Our TCG team remained steadfastly committed to our mission of serving our valued clients during the past year. We remain very thankful for our continued partnership.

TCG committed additional growth capital to the company last year, expanded services in many areas, and hired numerous additional employees. TCG experienced record growth and retention during the past year as well. Importantly, we have expanded our commitment to financial education and literacy, while continuing to provide strong, transparent, and high value financial solutions to our clients.

As a follow up to our note last year regarding our strategic planning and growth initiatives, we are very excited to announce that Trusted Capital Group will be continuing its growth and evolution by joining HUB International Limited (“HUB”). With offices throughout the United States and Canada, HUB is a privately held firm offering wealth management, financial services, retirement solutions, HR consulting, risk management and asset protection services. This partnership will provide many new resources and tools to TCG to further strengthen our solutions, and better position Trusted Capital Group to continue delivering best-in-class services and solutions for its clients. Our financial stability as a part of HUB will also increase, from its already strong position.

On or around July 1, 2021 (“Closing Date”), Trusted Capital Group’s operating subsidiaries are expected to become subsidiaries of HUB (collectively, the “TCG Operations”). The TCG Operations will continue to have the same locations and TCG personnel servicing your accounts, and the services being provided by our various subsidiaries (TCG Administrators, LP, TCG Advisory Services, LLC, TCG Consulting Services, LLC and Cypher Security, LLC) will continue in their normal course with no significant changes. Regarding any contracts that you have with TCG’s subsidiaries, those agreements will also remain in place and continue in accordance with this letter. Some of those agreements may specifically require your affirmative consent, including any investment advisory agreements with TCG Advisory Services, LLC (as this change of control to HUB is considered an assignment under the Investment Advisers Act of 1940). We therefore respectfully ask that you confirm your consent by signing below and returning this letter at your earliest convenience – or if more convenient, you can also send an email indicating your consent to [Consent@tcgservices.com](mailto:Consent@tcgservices.com).

All TCG partners are steadfastly supportive of our new partner, and all leaders running TCG will continue to be involved in the company. From founders to recent partners, everyone will play a role in tomorrow’s TCG while holding true to the values that made this firm great. As part of the transaction with HUB, and being committed to the future, TCG’s existing partners will acquire a significant ownership stake in HUB going forward.

The rate of change in the marketplace has never been faster. The size and scale necessary to continue best-in-class services continues to increase. TCG has always sought to evolve in order to meet our clients' needs, and we are confident this new chapter in our story will broaden our capabilities and allow us to deliver even better services and results for clients. We are very thankful for your continued partnership and trust in TCG as we move forward.

Please feel free to call me with any questions you may have.

Sincerely,

**TCG Group Holdings, LLP**  
**(d/b/a Trusted Capital Group)**

  
\_\_\_\_\_  
Signature

Scott Hauptmann  
\_\_\_\_\_  
Printed Name

Chief Operating Officer  
\_\_\_\_\_  
Title

ACCEPTED AND AGREED:

\_\_\_\_\_  
Signature

\_\_\_\_\_  
Printed Name

\_\_\_\_\_  
Title (if signing on behalf of an Entity)

\_\_\_\_\_  
Organization

# Personnel

This page  
intentionally  
left blank



This page  
intentionally  
left blank

# Information Items



Employee Count - June 2021

DIVISION	Full-Time								Part-Time								FT/PT
	A	I	O	P	S	T	TS	Total	A	AE	I	O	P	S	TS	Total	Total
Academic & Behavior School East	4	19	1	3	2	0	21	50	0	0	0	0	0	0	4	4	54
Academic & Behavior School West	3	22	0	2	2	0	22	51	0	0	1	0	0	0	2	3	54
Administration	6	0	0	0	4	0	0	10	0	0	0	0	0	0	0	0	10
Adult Education	10	0	1	0	11	0	0	22	1	132	0	1	0	0	0	134	156
Business Services	8	0	0	0	7	0	0	15	0	0	0	0	0	1	0	1	16
Center For Grants Development	5	0	0	0	1	0	0	6	0	0	0	0	0	0	0	0	6
Center Safe & Secure Schools	4	0	0	0	1	0	0	5	0	0	0	0	0	0	0	0	5
Choice Partners	13	0	0	0	5	0	0	18	0	0	0	0	0	0	0	0	18
Client Engagement	3	0	0	0	0	6	0	9	0	0	0	0	0	0	0	0	9
Communications & Creative Services	19	0	0	0	4	0	0	23	1	0	0	0	0	2	0	3	26
Center For Afterschool, Summer & Enrichment	4	0	0	0	1	0	0	5	0	0	0	0	0	1	0	1	6
Educator Certification & Advancement	6	0	37	0	6	0	0	49	0	0	0	0	0	0	0	0	49
Facilities	2	1	0	2	1	0	4	10	0	0	0	0	0	0	0	0	10
Fortis Academy	80	120	27	0	12	0	0	239	1	0	4	0	0	2	0	7	246
Head Start	2	3	0	2	3	0	19	29	0	0	1	0	0	0	1	2	31
Highpoint East	7	0	0	0	3	0	0	10	0	0	0	0	0	1	0	1	11
Human Resources	0	0	0	0	1	23	0	24	0	0	0	0	0	0	0	0	24
Information Technology Services	4	0	0	0	1	0	0	5	0	0	0	0	0	0	0	0	5
Purchasing Support	3	0	0	0	3	0	0	6	0	0	0	0	0	0	0	0	6
Records Management	2	0	7	0	5	0	0	14	0	0	0	0	0	0	0	0	14
Research & Evaluation	6	0	0	0	1	0	0	7	0	0	0	0	0	0	0	0	7
School-Based Therapy Services	1	0	0	90	27	0	0	118	0	0	0	0	35	4	0	39	157
Schools	3	0	0	1	2	0	0	6	0	0	0	1	0	0	2	3	9
Teaching & Learning Center	6	0	0	0	2	0	0	8	0	0	0	0	0	1	0	1	9
<b>Total</b>	<b>201</b>	<b>165</b>	<b>73</b>	<b>100</b>	<b>105</b>	<b>29</b>	<b>66</b>	<b>739</b>	<b>3</b>	<b>132</b>	<b>6</b>	<b>2</b>	<b>35</b>	<b>12</b>	<b>9</b>	<b>199</b>	<b>938</b>

A = Administration  
 AE = Adult Education  
 I = Instructional Support  
 O = Operations Support  
 P = Professional Support  
 S = Administrative Support  
 T = Technology  
 TS = Teachers

Meeting Date: July 21, 2021

## NOTICE OF FEDERAL INTEREST

**LEGAL NOTICE: THE PROPERTY NAMED IN THIS DOCUMENT WAS ACQUIRED OR IMPROVED USING FEDERAL FUNDING. THEREFORE, FEDERAL LAW GOVERNS ITS USE, ENCUMBRANCE, AND/OR DISPOSITION. BEFORE ATTEMPTING TO PURCHASE, SELL, OCCUPY, TAKE A MORTGAGE INTEREST IN OR OTHERWISE ENCUMBER, OR FORECLOSE UPON THIS PROPERTY, YOU MUST NOTIFY THE RESPONSIBLE HHS OFFICIAL LISTED BELOW.**

Federal law directs the Secretary of the United States Department of Health and Human Services to establish uniform procedures for Head Start agencies to purchase facilities to be used to carry out Head Start programs. *See* 42 U.S.C. § 9839(f). Real property acquired or improved with a Federal award is held in trust by the Head Start agency as trustee for the beneficiaries of the project or program under which the property was acquired or improved. *See* 45 C.F.R. §§ 75.323, 1303.46. Facilities acquired or renovated with grant funds may not be mortgaged, used as collateral, sold, or otherwise transferred to another party without the written permission of the responsible HHS official. *See* 45 C.F.R. § 1303.48(a).

On 1/8/2021, the United States Department of Health and Human Services, Administration for Children and Families (“HHS/ACF”) awarded Grant Number 06TD000167-01-00 in the amount of \$ 587,215.00 to Harris County Department of Education, with a current mailing address of 6300 Irvington Blvd, Houston, TX 77022 (“Recipient”) for the purpose of operating a Head Start program in Harris County, Texas. These grant funds are being used in part for the purchase, continued purchase, improvement, and/or renovation of the property located at 767 Coolwood Drive, Houston, Harris County, TX 77013 and further described on Exhibit A, attached hereto (“Property”). Future grant awards may also be used for this purpose.

Through this grant award and any future grant awards made by HHS/ACF, HHS/ACF has acquired a beneficial ownership interest (“Federal Interest”) in the Property. HHS/ACF’s interest applies to the entire Property, including, but not limited to, the facility and land.

The Notice of Award for this grant includes conditions on the use of the Property and provides for a continuing Federal Interest in the Property. Specifically, the Property may not be: (1) used for any purpose inconsistent with the Head Start Act and applicable Head Start regulations; (2) mortgaged or used as collateral, sold or otherwise transferred to another party, without the responsible HHS/ACF official’s (or the responsible HHS/ACF official’s designee’s) written permission; (3) subordinated, diminished, nullified or released through the encumbrance of the property, transfer of the property to another party or any other action the Recipient takes without the responsible HHS/ACF official’s (or the responsible HHS/ACF official’s designee’s) written permission. *See*: 42 U.S.C. § 9831 et seq.; 45 C.F.R. Part 75; 45 C.F.R. Part 1303; 45 C.F.R Part 1305; and other terms and conditions of the award, including the HHS Grants Policy Statement.

The Federal Interest in the Property and the conditions and restrictions that control the use, sale, lease, and disposition of the Property cannot be subordinated, diminished, nullified, or released through encumbrance of the Property, transfer of the Property to another party, or any other action taken by the Recipient without the Responsible HHS/ACF Official's written permission. In accordance with 45 C.F.R. § 75.318 and 45 C.F.R. § 1303.48(b), any party seeking to change the ownership or approved usage of the Property must provide advanced written notice requesting permission to make the proposed change to the Responsible HHS/ACF Official at the following address:

Stefanie Gordon  
Office of Grants Management  
Administration for Children and Families  
U.S. Department of Health and Human Services  
Stefanie.Gordon@acf.hhs.gov  
(646) 905-8061

Grantee confirms that Recipient's governing body received a copy of this Notice of Federal Interest on June 30, 2021.

The person(s) executing this Notice of Federal Interest on behalf of Recipient hereto represent and warrant that he or she has been duly authorized by Recipient to so execute this Notice of Federal Interest.

**IN WITNESS WHEREOF**, Recipient has executed this Notice of Federal Interest pursuant to authority duly given, as of July 8, 2021.

[Signature page follows.]

Harris County Department of Education, with a current mailing address of 6300 Irvington Blvd, 

By: \_\_\_\_\_  
Dr. Jesus J. Amezcua  
Assistant Superintendent of Business Services

On this \_\_\_\_\_ day of July \_\_\_\_\_, 2021 \_\_\_\_\_, before me, the undersigned, a Notary Public in and for said \_\_\_\_\_, personally appeared Dr. Jesus J. Amezcua, Assistant Superintendent of Business Services of Harris County Department of Education, personally known to me on the basis of satisfactory evidence to the individual, whose name is subscribed to the within instrument and acknowledged to me that he or she executed the same in he or she capacity, and that by he or she signature on the instrument, the individual, or the person upon behalf of which the individual acted, executed the instrument.

Notary Seal

\_\_\_\_\_  
Notary Public  
My Commission Expires: \_\_\_\_\_

EXHIBIT A

LEGAL PROPERTY DESCRIPTION

LEGAL DESCRIPTION

For a 0.4486 Acre [19,539 Square Feet] Parcel of Land

BEING A 0.4486 ACRE [19,539 SQUARE FEET] PARCEL OF LAND OUT OF THE CONCEPCION MARTINEZ SURVEY, ABSTRACT NUMBER 545, HARRIS COUNTY, TEXAS, SAID PARCEL OF LAND BEING A PORTION OF A CALLED 19,539 SQUARE FEET TRACT OF LAND CONVEYED TO ZIEBEN FOUNDATION PROPERTIES, LTD., AS RECORDED IN CLERK'S FILE No. 20100399233 OF THE HARRIS COUNTY OFFICIAL PUBLIC RECORDS OF REAL PROPERTY [H.C.O.P.R.R.P.], SAID 0.4486 ACRES BEING MORE PARTICULARLY DESCRIBED BY METES AND BOUNDS AS FOLLOWS:

BEGINNING at a found 1/2-inch iron rod found at the southwest corner of said 0.4486 acre tract, also being the northwest corner of a called 5.6586 acre tract of land conveyed to Equality Community Housing Corporation, under Clerk's File No. W552516 H.C.O.P.R.R.P., and being in the east right-of-way line of Coolwood Drive (60-foot wide) for the POINT OF BEGINNING of the herein described parcel of land;

THENCE North 02°15'45" West, along said east right-of-way line, common with the west line said 0.4486 acre tract, a distance of 134.78 feet to a 5/8-inch iron rod with plastic cap stamped "DOUCET" set for the northwest corner of said 0.4486 acre tract, same being a southwest corner of a called 6.446 acre tract of land conveyed to Houston Parks Board LGC., under Clerk's File No. 2018358596 H.C.O.P.R.R.P.;

THENCE North 87°44'15" East, along the north line of said 0.4486 acre tract, common with a south line of said 6.446 acre tract, a distance of 131.37 feet to a 1/2-inch iron rod with plastic cap stamped "Land-Tech" found for the northeast corner of said 0.4486 acre tract, same being an interior corner of said 6.446 acre tract;

THENCE South 02°15'45" East, continuing along said common line, a distance of 176.72 feet to a 1/2-inch iron rod with plastic cap stamped "Land-Tech" found for the southeast corner of said 0.4486 acre tract, same being the southwest corner of said 6.446 acre tract, and being in the north line of the aforementioned 5.6586 acre tract;

THENCE North 66°37'28" West, along the south line of said 0.4486 acre tract, common with the north line of said 5.6586 acre tract, a distance of 96.92 feet to a 1/2-inch iron rod found;

THENCE South 87°44'15" West, continuing along said common line, a distance of 44.00 feet to the POINT OF BEGINNING and containing 0.4486 acres [19,539 square feet].

Basis of bearings is the Texas Coordinate System, South Central Zone [4204], NAD83 (2011), Epoch 2010. All coordinates and distances are surface values and may be converted to grid by using the surface adjustment factor of 0.9998960.

Units: U.S. Survey Feet.

**Regular Board Meeting**

**13.D.**

**Meeting Date:** July 21, 2021

**Title:** Grant Recipients for CASE for Kids Partnership Project 2020-2021

**Submitted For:** Lisa Caruthers, Case for Kids **Submitted By:** Kimberlee Flowers

**Additional Resource Personnel:**

**Information**

**Posted Agenda Item:**

**The CASE for Kids Division awards three school districts and two charter school systems (aggregate amount \$550,700)**for delivery of comprehensive programs for the 2020-2021 school year: Alief ISD, Houston ISD, Pasadena ISD, Academy of Accelerated Learning Charter and Rhodes Performing Arts Charter.

**Subject:**

CASE for Kids Awards 22 recipients for the 2021 – 2022 CASE for Kids Partnership Project

**Rationale:**

The goal of the Partnership Project is to provide supplemental funding to comprehensive after-school programs to promote social and emotional learning skills (SEL), increased support of numeracy and literacy development for economically disadvantaged students between the ages of 4 and 12 or up to the age of 19 with a documented disability. In addition, supplemental funding will assist in program quality improvement and program expansion. CASE for Kids will provide funded projects with additional support for numeracy and literacy integration and SEL into academic and enrichment activities, as well as site-based assessment and coaching to improve overall program quality.

The CASE for Kids Partnership Project is the result of collaboration between HCDE, the Houston-Galveston Area Council (H-GAC), the Texas Workforce Commission (TWC) and awarded sites. HCDE commits local funds to supplement comprehensive afterschool programming. HCDE and site match dollars activate a commitment of federal childcare funds for quality improvement for school-age youth through TWC. This allows HCDE to provide a variety of resources to selected sites such as: site visits, training, and access to curriculum and materials through a free lending library. Awarded sites will demonstrate the ability to provide a comprehensive program and utilize CASE for Kids’ funds as an additional resource to target students in need of academic assistance. Interlocals will follow as needed for board approval.

**Attachments**

Partnership Awardees

**Form Review**

**Inbox**  
CASE  
Form Started By: Kimberlee Flowers  
Final Approval Date: 06/29/2021

**Reviewed By**  
Lisa Caruthers

**Date**  
06/28/2021 06:15 PM  
Started On: 06/28/2021 03:32 PM



## 2021-2022 CASE for Kids Partnership Project: Award Announcement

The Center for Afterschool, Summer and Enrichment for Kids, CASE for Kids, a division of Harris County Department of Education, announces the CASE for Kids Partnership Project awards for out-of-school time programming in the 2021-2022 school year. The CASE for Kids Partnership Project is the result of collaboration between HCDE, the Houston-Galveston Area Council (HGAC), the Texas Workforce Commission (TWC) and awarded sites. HCDE commits local funds to supplement afterschool programming.

The goal of the Partnership Project is to provide supplemental funding to afterschool programs to promote social and emotional learning skills and increased support of numeracy and literacy development for economically disadvantaged students between ages 4-12 or up to age 19 with a documented disability. CASE for Kids will provide more than \$550,000 to fund 22 projects in Harris County. Awarded sites will provide a program and utilize funds as a supplemental resource to target students in need of academic assistance.

### CASE for Kids Partnership Project 2021 – 2022 Awards

Awarded Organization	Site	Award Amount
Alief ISD	Cummings Elementary	\$27,050
Alief ISD	Heflin Elementary	\$27,050
Alief ISD	Liestman Elementary	\$27,050
Alief ISD	Mahanay Elementary	\$27,050
Alief ISD	Martin Elementary	\$27,050
Alief ISD	Miller Intermediate	\$27,050
Alief ISD	Outley Elementary	\$27,050
Charter	Academy of Accelerated Learning – Belfort	\$27,050
Charter	Academy of Accelerated Learning – Chimney Rock	\$27,050
Charter	Rhodes School for Performing Arts – Humble	\$27,050
Charter	Rhodes School for Performing Arts – NW	\$27,050
Houston ISD	Benbrook Elementary	\$25,000
Houston ISD	Briscoe Elementary	\$10,000
Houston ISD	Burnet Elementary	\$25,000
Houston ISD	Davila Elementary	\$27,050
Houston ISD	Ed White Elementary	\$26,000
Houston ISD	Forest Brook Elementary	\$24,000
Houston ISD	Lyons Elementary	\$20,000
Houston ISD	Marshall Elementary	\$27,050
Houston ISD	Oates Elementary	\$27,000
Houston ISD	Valley West Elementary	\$15,000
Pasadena ISD	Frazier Elementary	\$27,050

**Regular Board Meeting****13.E.**

**Meeting Date:** July 21, 2021  
**Title:** CASE for Kids County Connections- Youth Summer Initiative Award List  
**Submitted For:** Lisa Caruthers, Case for Kids **Submitted By:** Kimberlee Flowers  
**Additional Resource Personnel:** Danielle Bartz, Dr. Lisa Caruthers,  
 Dr. Jesus Amezcua, Bill Monroe,  
 Kendra Jackson

**Information****Posted Agenda Item:**

**The CASE for Kids Division awards 43 nonprofit organizations (aggregate amount \$625,000), for delivery of comprehensive programs,** short-term projects and online college and career readiness programs to serve youth across four Harris County Precincts for Summer of 2021.

**Subject:**

CASE for Kids awards 43 nonprofit organizations grant awards for the 2021 – 2022 CASE for Kids County Connections Youth Summer Initiative.

**Rationale:**

The City Connections Project, funded directly by the City of Houston and administered by CASE for Kids, supports not-for-profit organizations that address the need for youth services outside the school day. City Connections programming takes place in a variety of locations throughout the city of Houston including schools, community centers, apartment complexes and churches. The funded organizations will provide diverse activities for youth during the out-of-school time frame including fine arts, academic enrichment, college exploration, and fitness classes. Grants are designed to meet individual Houston city council district needs and provide prevention-based programming that addresses gaps in services to youth.

**Harris County Precinct One**

<b>Organization</b>	<b>Award Amount</b>
Boys & Girls Clubs of Greater Houston (Morefield Club, Allen Parkway Club)	\$5,000.00
The FORGE for Families	\$20,000.00
Perfect Connection (Kashmere Gardens Early Learning Center)	\$3,500.00
SHAPE Community Center, Inc.	\$20,000.00
HYPE Freedom School, Inc. (Jones Memorial United Methodist Church)	\$15,000.00
Art League of Houston	\$19,500.00

Change Happens	\$3,500.00
the FORGE for Families (Basketball)	\$10,000.00
Girlstart (Klentzman Intermediate)	\$5,000.00
HITS Theatre	\$14,000.00
Houston Tennis Association (Cleveland Park, Clinton Park, Crestmont Park, Dodson Lake Park, Finnigan Park, Haviland Park, Highland Park, Hutchenson Park, Melrose Park, Platou Park, Sagemont Park, Scenic Woods Park, Sunnyside Park, Tidwell Park, Westwood Park, Winsor Village Park)	\$9,700.00
M.E.N. (Mentoring, Education & Nurturing) INC. (Buffalo Soldier National Museum)	\$3,500.00
Recipe for Success Foundation (Hope Farms)	\$3,500.00
Safe Place Outreach (Grace Church International)	\$12,150.00
The Ensemble Theatre (Arrow Academy Harvest Preparatory)	\$3,000.00
Urban Harvest (Gregory Lincoln Education Center, Mading Elementary)	\$3,500.00
Workshop Houston	\$3,500.00
Young Audiences of Houston (Yellow Stone Academy)	\$3,500.00
A Yancy Life Transition Center (First Mount Carmel Missionary Baptist Church)	\$14,000.00
YMCA of Greater Houston (Houston Texans YMCA)	\$5,500.00
<b><u>Harris County Precinct Two</u></b>	
Organization	Award Amount
Wesley Community Center, Inc.	\$15,000.00

Community Family Centers (JP McGovern Sports and Recreation Center) \$20,000.00

HYPE Freedom School, Inc. (Ebenezer United Methodist) \$15,000.00

Multicultural Education and Counseling through the Arts \$20,000.00

SUPERGirls SHINE Foundation (Parkgate Community Church) \$4,000.00

Boys & Girls Clubs of Greater Houston (Havard Club, Texans Teen Club) \$5,000.00

Avenue Community Development Corporation (Las Brisas, Avenue Terrace, Washington Courtyards, Avenue Station Oak Arbor, Redwood Heights) \$4,000.00

Community Family Centers A&M Project (JP McGovern Sports and Recreation Center) \$10,000.00

Comp-U-Dopt Inc. \$20,000.00

Houston Tennis Association (Charlton Park, Meadowcreek Park, Montie Beach Park, Moody Park, Wilson Memorial Park, Woodland Park, Mason Park, Dow Park, Freeway Manor Park, Greenwood Park, Hartman Park, Keith-Weiss Park, Settegast Park) \$12,800.00

Neighbors in Action \$6,100.00

Young Audiences of Houston (Wesley Community Center) \$5,000.00

Diaz Music Institute (MacArthur High School) \$20,000.00

**Harris County Precinct Three**

**Organization** **Award Amount**

My Connect Community \$14,000.00

Chinese Community Center, Inc. \$20,000.00

American Festival for the Arts (AFA) (St. Luke's Gethsemane Church)	\$15,000.00
BakerRipley (Sharpstown Community Center)	\$14,000.00
BakerRipley (Sharpstown Community Center - FabLab)	\$8,300.00
Houston reVision (St. Luke's United Methodist Church)	\$3,500.00
Social Motion Inc.	\$20,000.00
YMCA of Greater Houston (Alief Family YMCA, Langham Creek YMCA, Trotter YMCA)	\$13,504.00
Evelyn Rubenstein Community Center	\$20,000.00
Texas 4H Foundation (Steve Radack Community Center)	\$6,664.00
Knowledge First Empowerment Center - LevelUp!	\$9,500.00
BRIDGEYEAR (Wisdom High School)	\$5,750.00
Alliance for Multicultural Community Services (The Kijana Youth Program)	\$9,303.00

**Harris County Precinct Four**

<b>Organization</b>	<b>Award Amount</b>
Choice Nation Academy	\$16,020.00
Boys and Girls Club of Greater Houston (Spring Branch Club, Buffalo Creek Club)	\$20,000.00
College Community Career (Northbrook High School, Benjamin Davis High School)	\$20,000.00
EZ Kids Creativity Shell (Humble Elementary School)	\$10,000.00
Houston Tennis Association (Graham Park, Memorial Park, Johnson Park, Cole Creek Park, Mangum Park, Wright-Bembry Park)	\$8,400.00
HTC Youth Center	\$20,000.00
YMCA of Greater Houston (Lake Houston YMCA, D. Bradley McWilliams YMCA)	\$10,996.00
Consumer Energy Education	\$20,000.00

---

**Attachments**

county connections

---

**Form Review**

<b>Inbox</b>	<b>Reviewed By</b>	<b>Date</b>
CASE	Lisa Caruthers	06/28/2021 06:15 PM
Form Started By: Kimberlee Flowers		Started On: 06/28/2021 04:02 PM
Final Approval Date: 06/29/2021		

## CASE for Kids

# County Connections Youth Summer Initiative 2021

## Grant Award List

The Center for Afterschool, Summer and Enrichment for Kids, or CASE for Kids, is a division of Harris County Department of Education (HCDE) that was formed in 1999. The vision of CASE for Kids is to ensure that every child in Harris County will have access to high-quality, expanded learning opportunities. CASE for Kids believes a quality out-of-school time program provides avenues for opportunities for youth to excel, explore and expand their horizons before school, after school, on weekends and during the summer. A quality program provides a safe and inclusive environment, diverse learning opportunities, effective administrative strategies, collaborative relationships, and intentional program promotion.



**County Connections Youth Summer Initiative 2021**, funded directly by Harris County, supports nonprofit organizations that address the need for youth services during the summer. Initiatives funded by the CASE for Kids County Connections program provide comprehensive summer programs, short term projects and summer camps hosted in-person or virtually from a variety of locations including schools, community centers, apartment complexes and churches. In addition, organizations will provide synchronous or asynchronous college and career readiness initiatives for older youth delivered virtually through CASE for Kids LevelUp online learning platform. Initiatives are customized to meet community needs of individual Harris County Precincts. Services include resources or reduce cost for summer initiatives for families during pandemic conditions.

The nonprofit organizations listed have been awarded a **County Connections Youth Summer Initiative 2021** grant award. Funding for the **County Connections Project** is provided by **Harris County** and administered by the Center for Afterschool, Summer and Enrichment for Kids or CASE for Kids, a division of Harris County Department of Education. A total of 117 applications were received requesting funding. More than \$600,000 was awarded to over 40 organizations to provide engaging summer activities to sites across the county. The organizations listed on the following pages will provide diverse activities for youth including fine arts, academic enrichment, college exploration and youth mentoring. Congratulations to all grant recipients! We are grateful to Harris County for their investment and support of out-of-school time programming.

## Harris County Precinct 1

Grantee	Project Site	Total Award Amount
The FORGE for Families	The FORGE for Families	\$20,000
SHAPE Community Center, Inc.	SHAPE Community Center	\$20,000
Art League of Houston	Art League Houston	\$19,500
HYPE Freedom Schools, Inc.	Jones Memorial United Methodist Church	\$15,000
HITS Theater	HITS Theater	\$14,000
Yancy Life Center	First Mount Carmel Missionary Baptist Church	\$14,000
Safe Place Outreach	Grace Church International	\$12,150
The FORGE for Families	The FORGE for Families - Basketball	\$10,000
Houston Tennis Association	Cleveland Park, Clinton Park, Crestmont Park, Dodson Lake Park, Finnigan Park, Haviland Park, Highland Park, Hutchenson Park, Melrose Park, Platou Park, Sagemont Park, Scenic Woods Park, Sunnyside Park, Tidwell Park, Westwood Park, Winsor Village Park	\$9,700
YMCA of Greater Houston	Houston Texans YMCA	\$5,500
Boys and Girls Club of Greater Houston	Morefield Club, Allen Parkway Club	\$5,000
Girlstart	Klentzman Intermediate	\$5,000
Change Happens	Change Happens	\$3,500

### Harris County Precinct 1 (continued)

Grantee	Project Site	Total Award Amount
M.E.N. Inc.	Buffalo Soldier National Museum	\$3,500
Perfect Connection	Kashmere Gardens Early Learning Center	\$3,500
Recipe for Success	Hope Farms	\$3,500
The Ensemble Theatre	Arrow Academy Harvest Preparatory	\$3,500
Urban Harvest	Gregory Lincoln Education Center, Mading Elementary	\$3,500
Workshop Houston	Workshop Houston	\$3,500
Young Audiences of Houston	Yellow Stone Academy	\$3,500

### Harris County Precinct 2

Grantee	Project Site	Total Award Amount
Multicultural Counseling and Education for the Arts	MECA Dow School	\$20,000
Community Family Centers	JP McGovern Sports and Recreation Center	\$20,000
Diaz Music	MacArthur High School	\$20,000
Comp-U-Dopt	Comp-U-Dopt	\$20,000
HYPE Freedom School	Ebenezer United Methodist	\$15,000
Wesley House	Wesley Community Center	\$15,000



## Harris County Precinct 2 (continued)

Grantee	Project Site	Total Award Amount
Houston Tennis Association	Charlton Park, Meadowcreek Park, Montie Beach Park, Moody Park, Wilson Memorial Park, Woodland Park, Mason Park Dow Park, Freeway Manor Park, Greenwood Park, Hartman Park, Keith-Weiss Park, Settegast Park	\$12,800
Community Family Centers A&M Project	JP McGovern Sports and Recreation Center	\$10,000
Neighbors in Action	Neighbors in Action	\$6,100
Young Audiences of Houston	Wesley Community Center	\$5,000
Boys and Girls Club Greater Houston	Havard Club, Texans Teen Club	\$5,000
Avenue CDC	Las Brisas, Avenue Terrace, Washington Courtyards, Avenue Station Oak Arbor, Redwood Heights	\$4,000
SUPERGirls	Parkgate Community Church	\$4,000

## Harris County Precinct 3

Grantee	Project Site	Total Award Amount
Chinese Community Center	Chinese Community Center	\$20,000
Evelyn Rubenstein Community Center	Evelyn Rubenstein Community Center	\$20,000
My Connection Community	Connect Community Hub	\$14,000
Social Motion Inc.	Social Motion Inc.	\$20,000
American Festival for the Arts	St. Luke's Gethsemane Church	\$15,000

### Harris County Precinct 3 (continued)

Grantee	Project Site	Total Award Amount
BakerRipley	Sharpstown Community Center	\$14,000
YMCA	Alief Family YMCA, Langham Creek YMCA, Trotter YMCA	\$13,504
Knowledge First - LevelUp!	Knowledge First	\$9,500
The Alliance	The Kijana Youth Program	\$9,303
BakerRipley	Sharpstown Community Center - FabLab	\$8,300
Texas 4H Foundation	Steve Radack Community Center	\$6,664
BridgeYear – LevelUp!	Wisdom High School	\$5,750
Houston reVision	St. Luke's United Methodist Church	\$3,500

### Harris County Precinct 4

Grantee	Project Site	Total Award Amount
Boys and Girls Club Greater Houston	Spring Branch Club, Buffalo Creek Club	\$20,000
College Community Career	Northbrook High School, Benjamin Davis High School	\$20,000
HTC Youth Center	HTC Youth Center	\$20,000
Consumer Energy Education	Consumer Energy Education	\$20,000
Choice Nation Academy	Choice Nation Academy	\$16,020
YMCA	Lake Houston YMCA, D. Bradley McWilliams YMCA	\$10,996
EZ Kids Creativity Shell	Humble Elementary School	\$10,000

### Harris County Precinct 4 (continued)

Grantee	Project Site	Total Award Amount
Houston Tennis Association	Graham Park, Memorial Park, Johnson Park, Cole Creek Park, Mangum Park, Wright-Bembry Park	\$8,400